



US00D972192S

(12) **United States Design Patent** (10) **Patent No.:** **US D972,192 S**
Liao (45) **Date of Patent:** **** Dec. 6, 2022**

(54) **SOLAR WALL LIGHT**

D903,181 S 11/2020 Fu
D910,897 S * 2/2021 Liu D26/67
D917,759 S 4/2021 Zhou

(71) Applicant: **Jia Liao**, Zhuhai (CN)

(72) Inventor: **Jia Liao**, Zhuhai (CN)

(**) Term: **15 Years**

(21) Appl. No.: **29/787,405**

(22) Filed: **Jun. 7, 2021**

(51) **LOC (13) Cl.** **26-03**

(52) **U.S. Cl.**
USPC **D26/87**

(58) **Field of Classification Search**
USPC D26/40, 41, 67, 68, 85, 87, 92
CPC F21S 8/03; F21S 8/033; F21S 8/036; F21S
8/081; F21S 9/037; F21W 2111/02;
F21W 2111/023; F21W 2132/109
See application file for complete search history.

(56) **References Cited**

U.S. PATENT DOCUMENTS

D63,053 S * 9/1923 Klein D26/85
D539,462 S * 3/2007 Dolan D26/92
D694,458 S * 11/2013 Yang D26/85
D806,306 S 12/2017 Yang
D834,736 S 11/2018 Liu
D837,438 S * 1/2019 Xie D10/106.8
D847,398 S 4/2019 Chen
D853,620 S * 7/2019 Zhang D26/87
D865,256 S 10/2019 Zou
D870,952 S 12/2019 Tan
D875,991 S 2/2020 Wan
D882,855 S 4/2020 Liu
D899,664 S 10/2020 Mai

OTHER PUBLICATIONS

Gama Sonic Outdoor Solar Light Fixture, ASIN: GS-114B-FPW-BLK. Available from amazon.com as early as May 19, 2019. (Year: 2019).*

SmartYard Solar Outdoor Wall Sconce Available from outdoorsolaroutlet.com as early as Jun. 18, 2019. (Year: 2019).*

LeiDrail Solar fence light, ASIN: B08Z799L7Z. Available from amazon.com May 1, 2021. (Year: 2021).*

* cited by examiner

Primary Examiner — Clare E Heflin

(74) *Attorney, Agent, or Firm* — Rumit Ranjit Kanakia

(57) **CLAIM**

The ornamental design for a solar wall light, as shown and described.

DESCRIPTION

FIG. 1 is a front elevational view of a solar wall light showing my new design;

FIG. 2 is a rear elevational view thereof;

FIG. 3 is a left side elevational view thereof;

FIG. 4 is a right side elevational view thereof;

FIG. 5 is a top plan view thereof;

FIG. 6 is a bottom plan view thereof;

FIG. 7 is a perspective view thereof; and,

FIG. 8 is another perspective view thereof.

The broken lines in the figures are for the purpose of illustrating portions of the Solar wall light, which form no part of the claimed design.

1 Claim, 8 Drawing Sheets

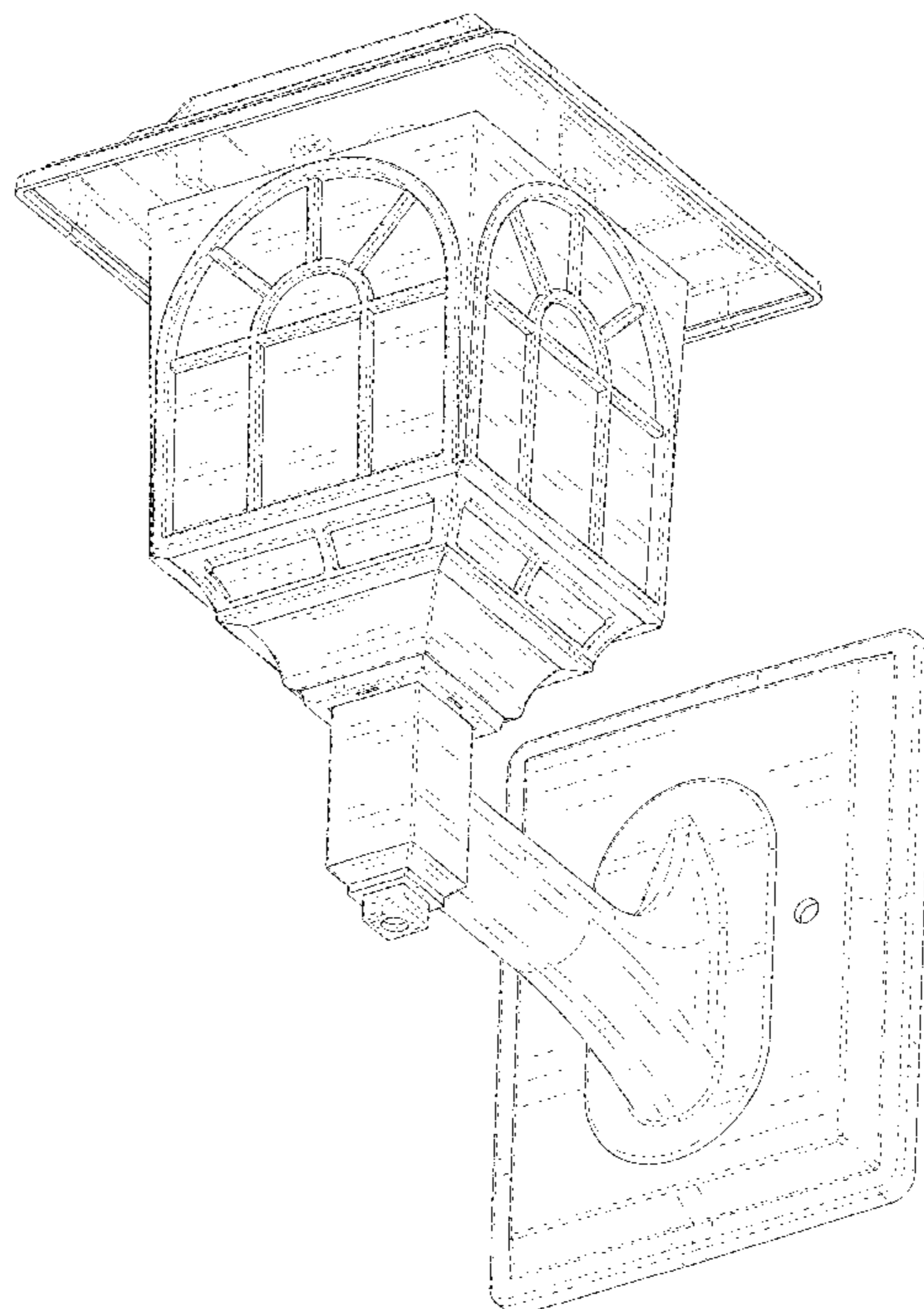

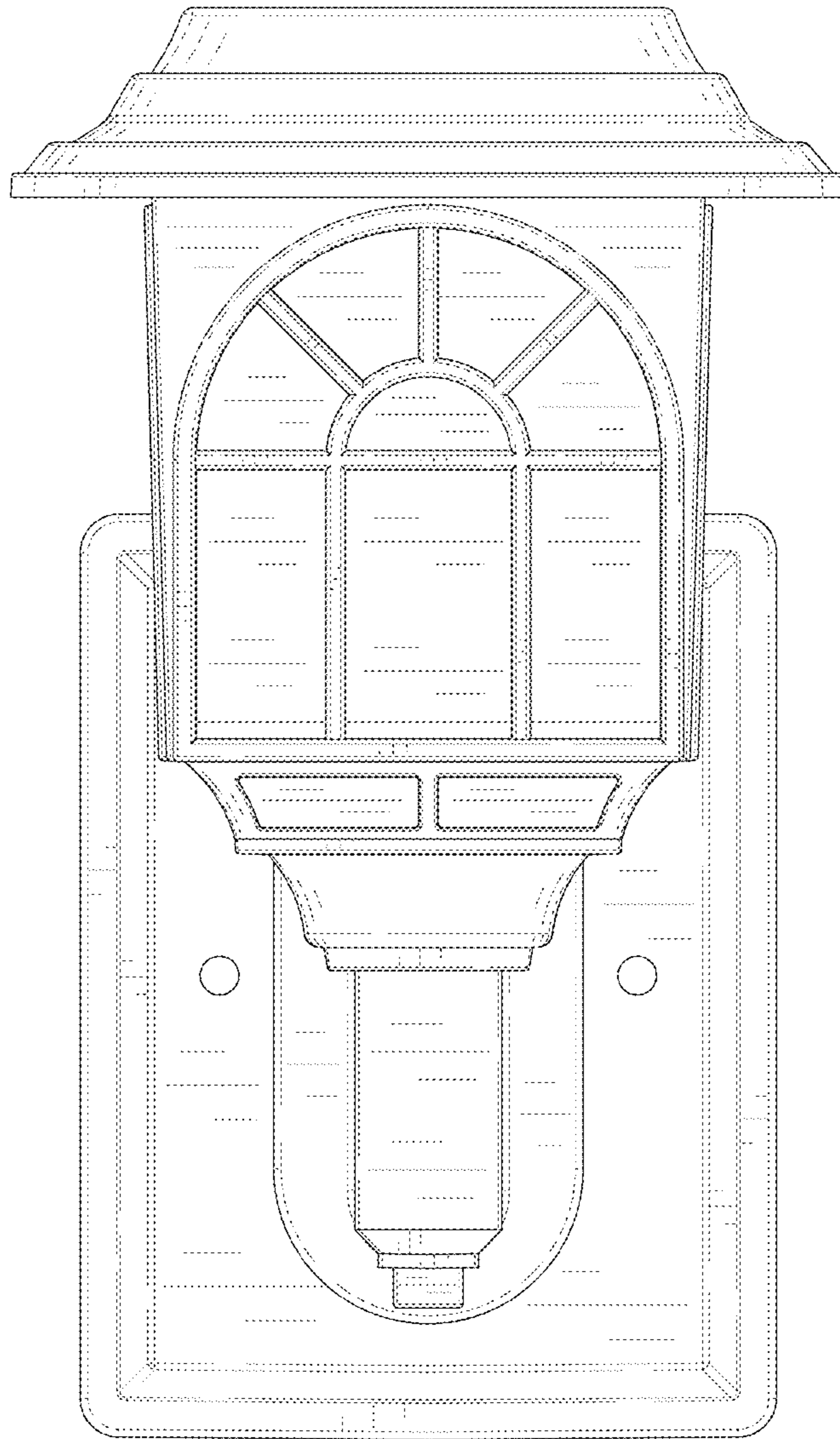

FIG. 1

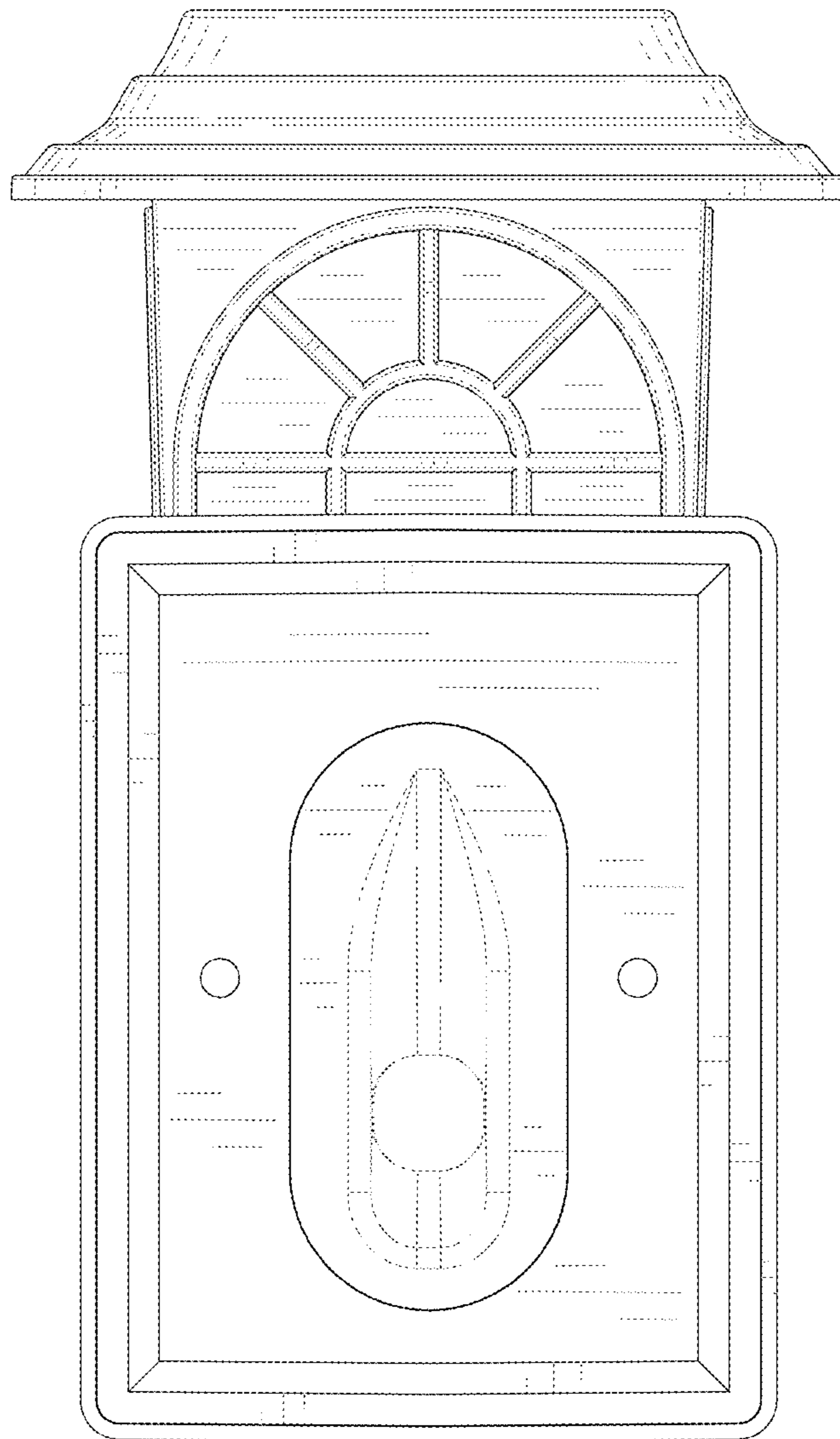

FIG. 2

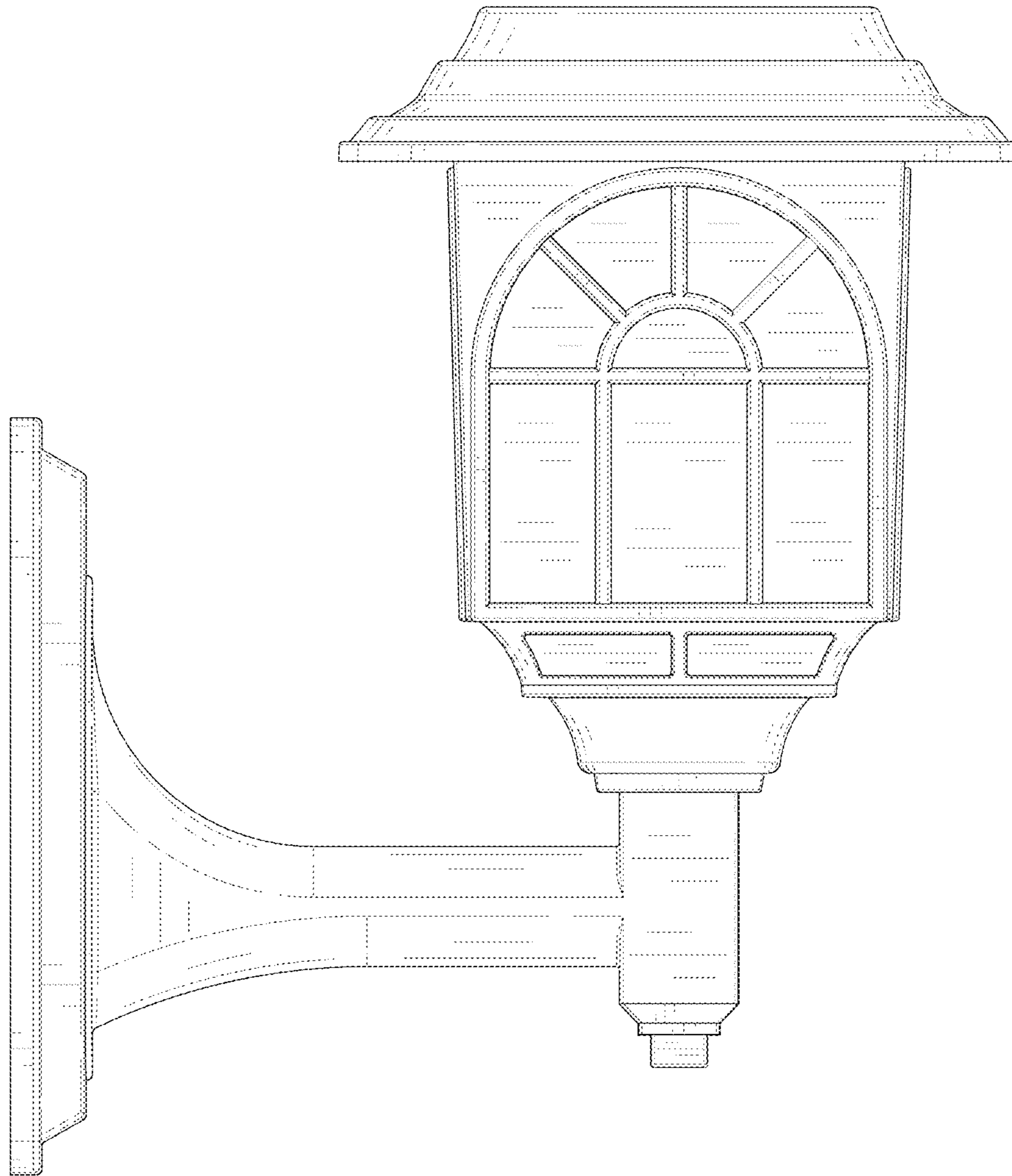

FIG. 3

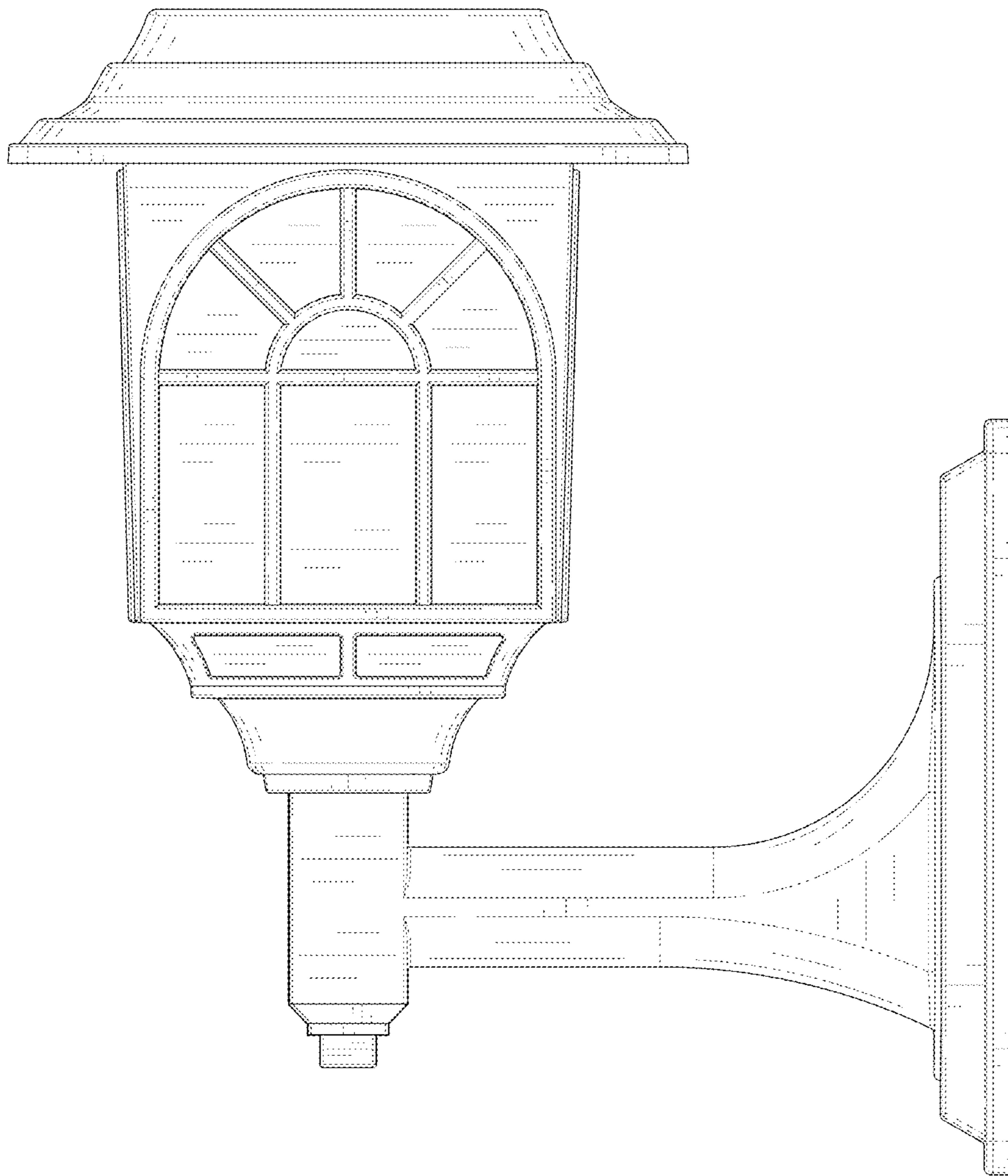

FIG. 4

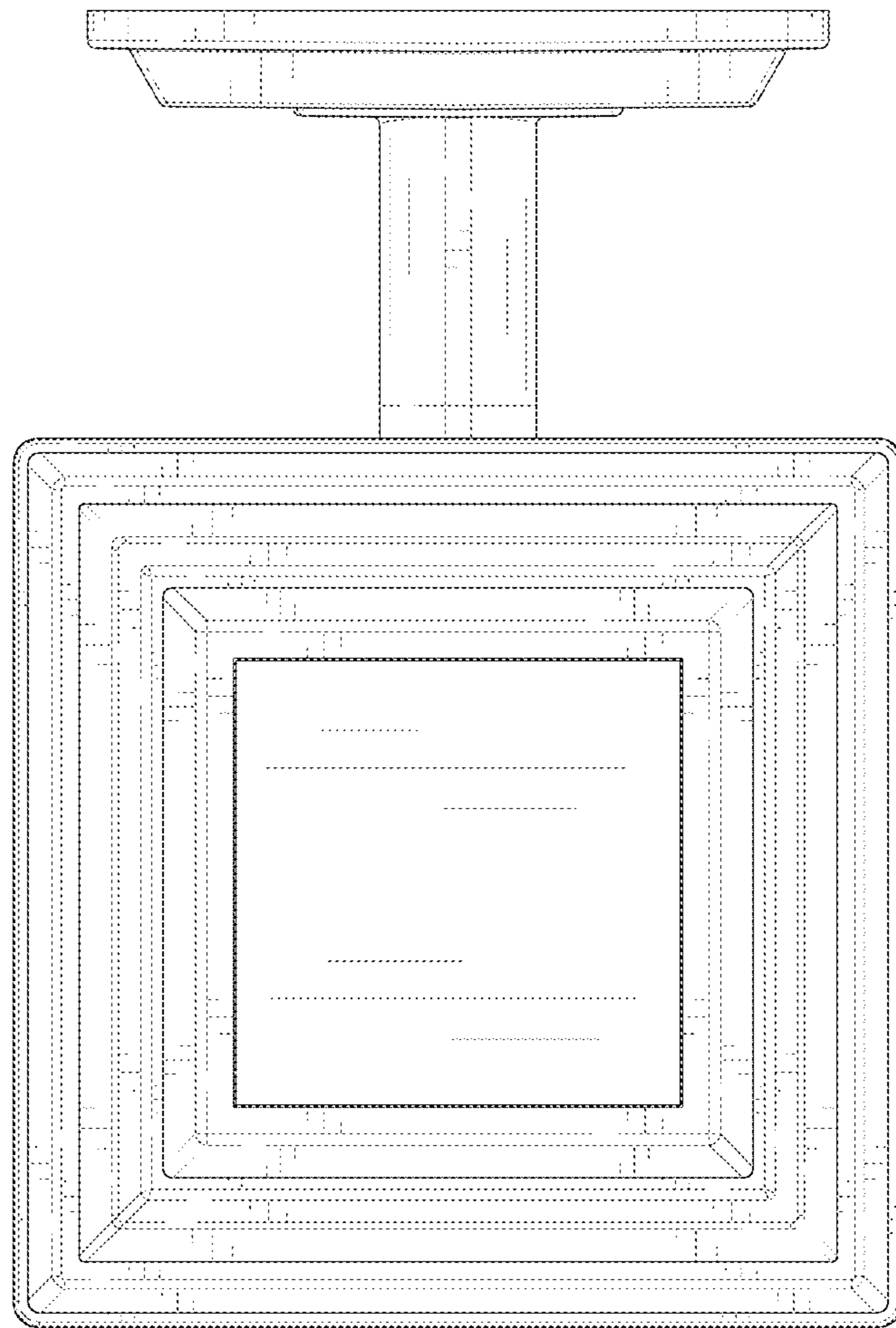

FIG. 5

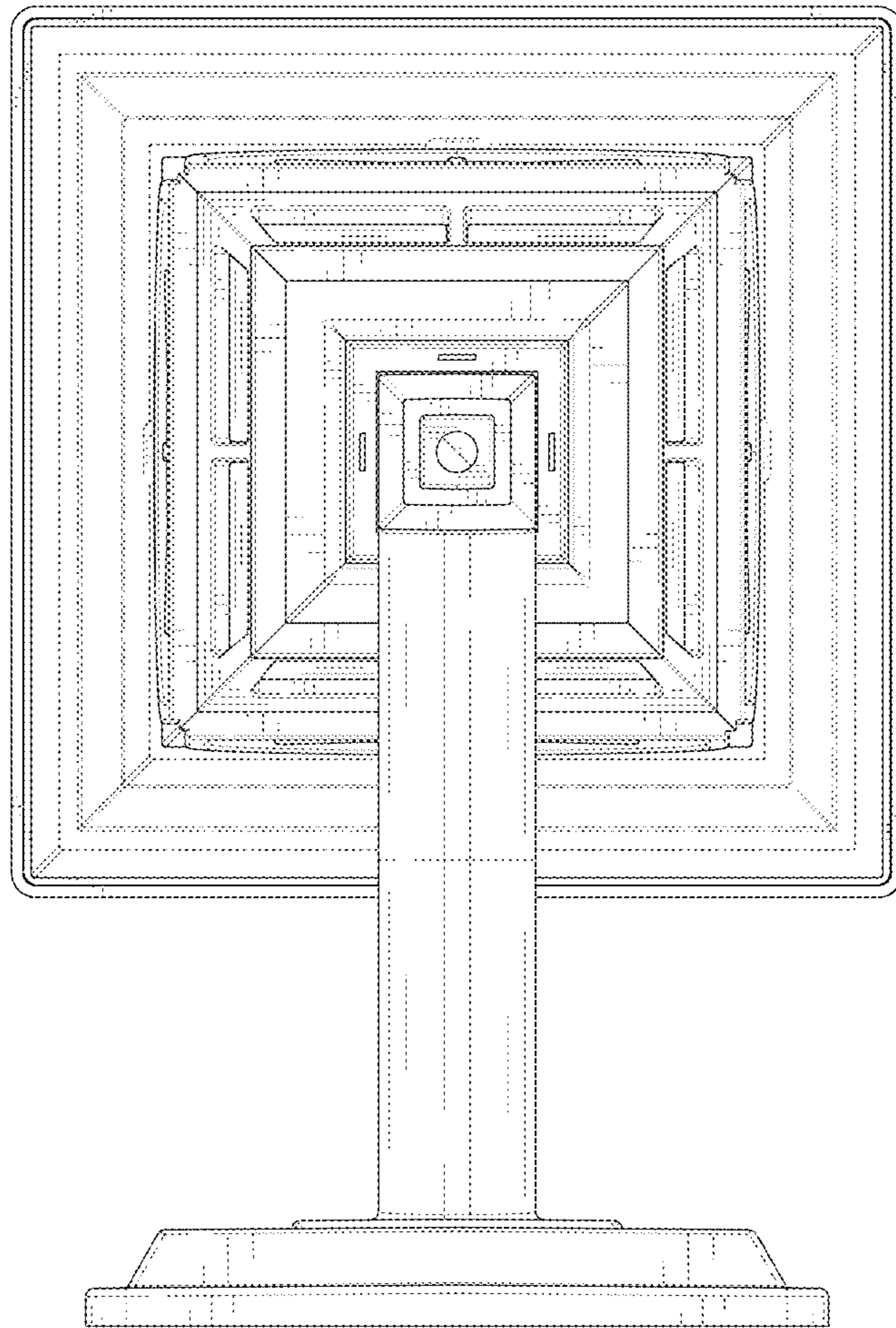

FIG. 6

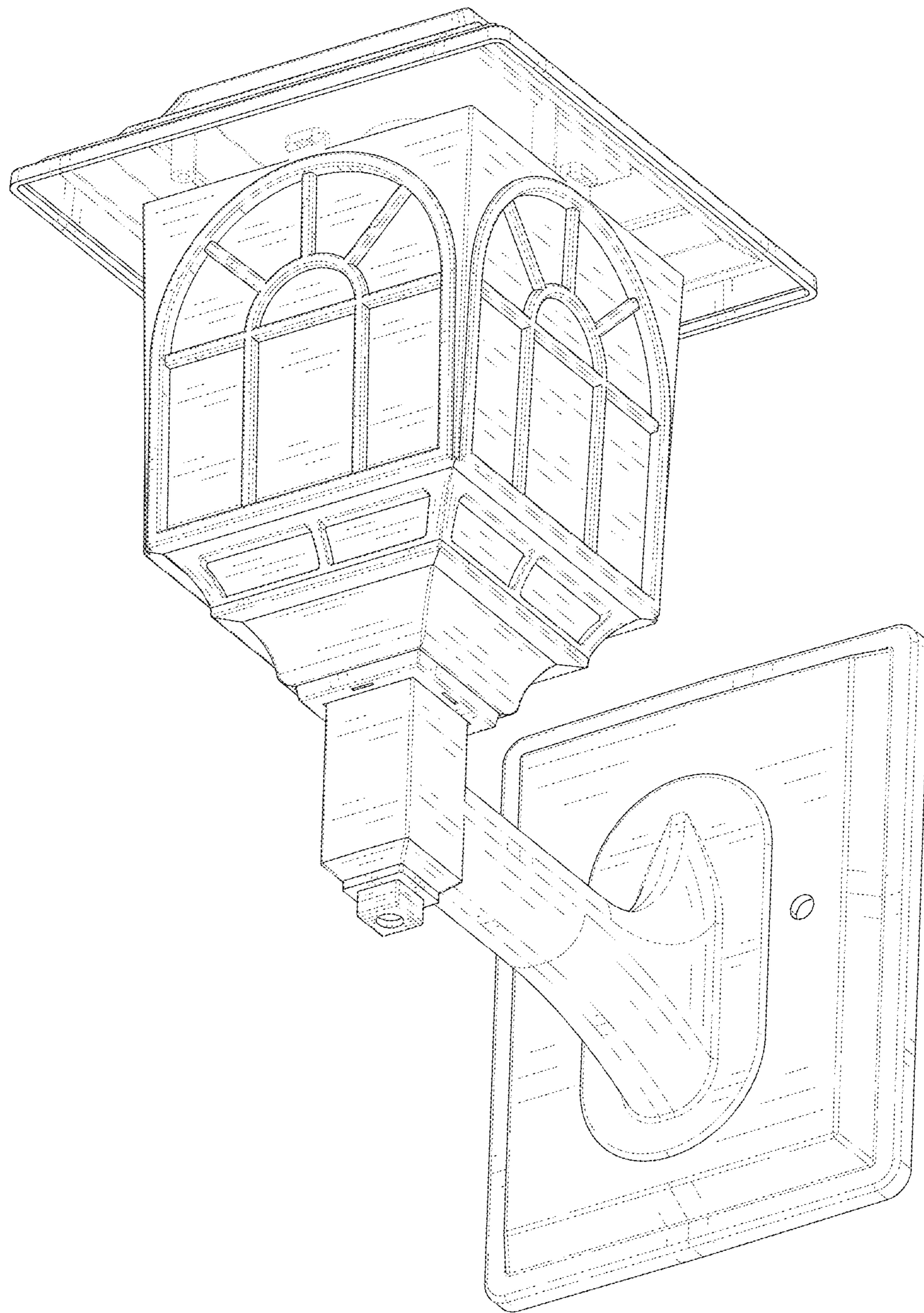

FIG. 7

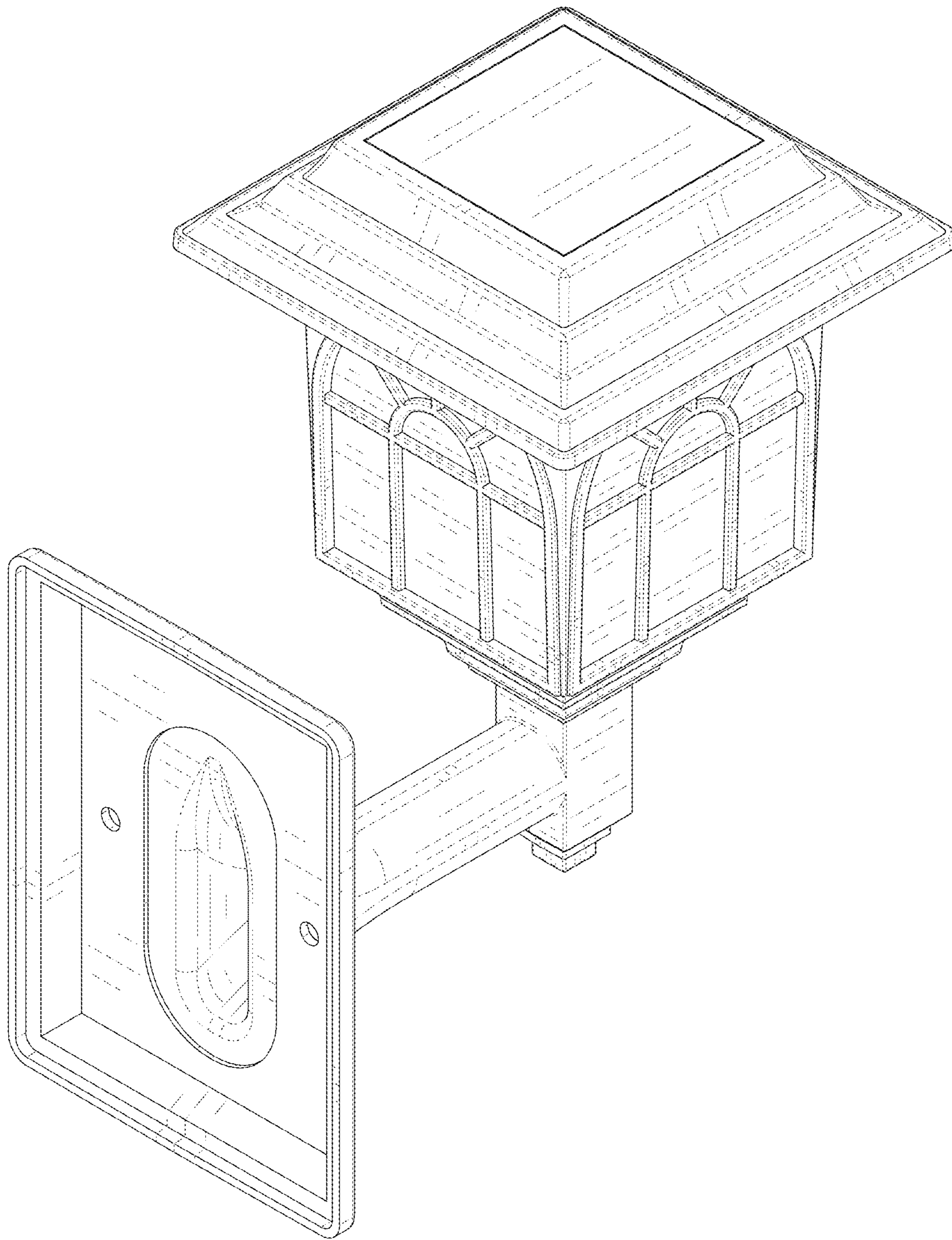

FIG. 8