

US00D972172S

(12) **United States Design Patent** (10) **Patent No.:** **US D972,172 S**
McIntyre et al. (45) **Date of Patent:** **** Dec. 6, 2022**

(54) **PAVING BLOCK**

FOREIGN PATENT DOCUMENTS

(71) Applicant: **HENGSTONE HOLDINGS, INC.**,
Toronto (CA)

CN 302204190 * 11/2012

Primary Examiner — Leanne Was-Englehart

(72) Inventors: **Mike McIntyre**, Mississauga (CA);
Scott Swierad, Caledon (CA); **Ray**
Rodenburgh, Rockwood (CA); **Aaron**
Bailey, Millbrook (CA); **Wilhelm**
Engelmann, Staig (DE)

(74) *Attorney, Agent, or Firm* — Lorelei G. Graham

(57) **CLAIM**

The ornamental design for a paving block, as shown and described.

(73) Assignee: **HENGSTONE HOLDINGS, INC.**

DESCRIPTION

(**) Term: **15 Years**

(21) Appl. No.: **29/738,801**

(22) Filed: **Jun. 19, 2020**

(30) **Foreign Application Priority Data**

Jun. 18, 2020 (CA) CA 196361

(51) **LOC (13) Cl.** **25-01**

(52) **U.S. Cl.**
USPC **D25/113**

(58) **Field of Classification Search**

USPC D21/484-504; D25/112-118

CPC E01C 5/00; E01C 2201/02; E01C 2201/20;
E01C 2201/205

See application file for complete search history.

(56) **References Cited**

U.S. PATENT DOCUMENTS

D27,761 S * 10/1897 Mark D25/106
D293,822 S * 1/1988 Scheiwiller D25/113
D438,988 S * 3/2001 Dean, Jr. D25/113
D461,011 S * 7/2002 Stepanchick D25/113
D601,268 S * 9/2009 Hanna D25/113
D674,115 S * 1/2013 Merriam D25/113

(Continued)

FIG. 1 is a front perspective view of a paving block showing our new design;

FIG. 2 is a top view of the paving block;

FIG. 3 is a bottom view of the paving block;

FIG. 4 is a front view of the paving block;

FIG. 5 is a back view of the paving block;

FIG. 6 is a left side view of the paving block;

FIG. 7 is a right side view of the paving block;

FIG. 8 is a front perspective view of a paving block showing our new design according to a second embodiment;

FIG. 9 is a top view of the paving block according to the second embodiment;

FIG. 10 is a bottom view of the paving block according to the second embodiment;

FIG. 11 is a front view of the paving block according to the second embodiment;

FIG. 12 is a back view of the paving block according to the second embodiment;

FIG. 13 is a left side view of the paving block according to the second embodiment; and,

FIG. 14 is a right side view of the paving block according to the second embodiment.

The dashed broken lines shown in the drawings are for the purpose of illustrating portions of the paving block that form no part of the claimed design.

The drawings contain a symbolic break in the form of dot-dash lines. The portion between the break lines forms no part of the claimed design.

1 Claim, 10 Drawing Sheets

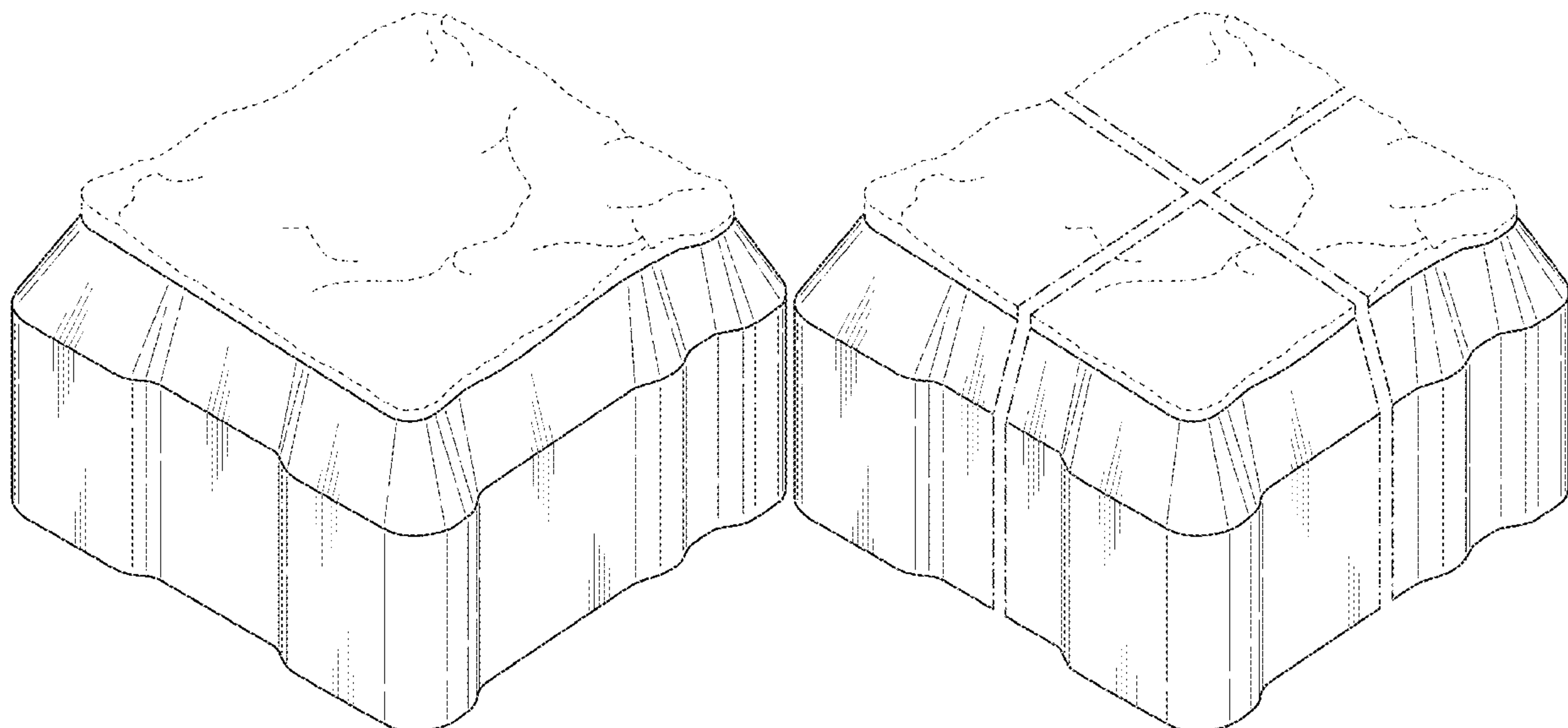

(56)

References Cited

U.S. PATENT DOCUMENTS

8,425,146 B2 *	4/2013	Merriam	E01C 5/00 404/39
D693,482 S *	11/2013	Merriam	D25/113
D735,890 S *	8/2015	Gleason	D25/113
D824,542 S *	7/2018	Lundell	D25/113
2012/0213582 A1 *	8/2012	Merriam	E01C 5/00 404/34

* cited by examiner

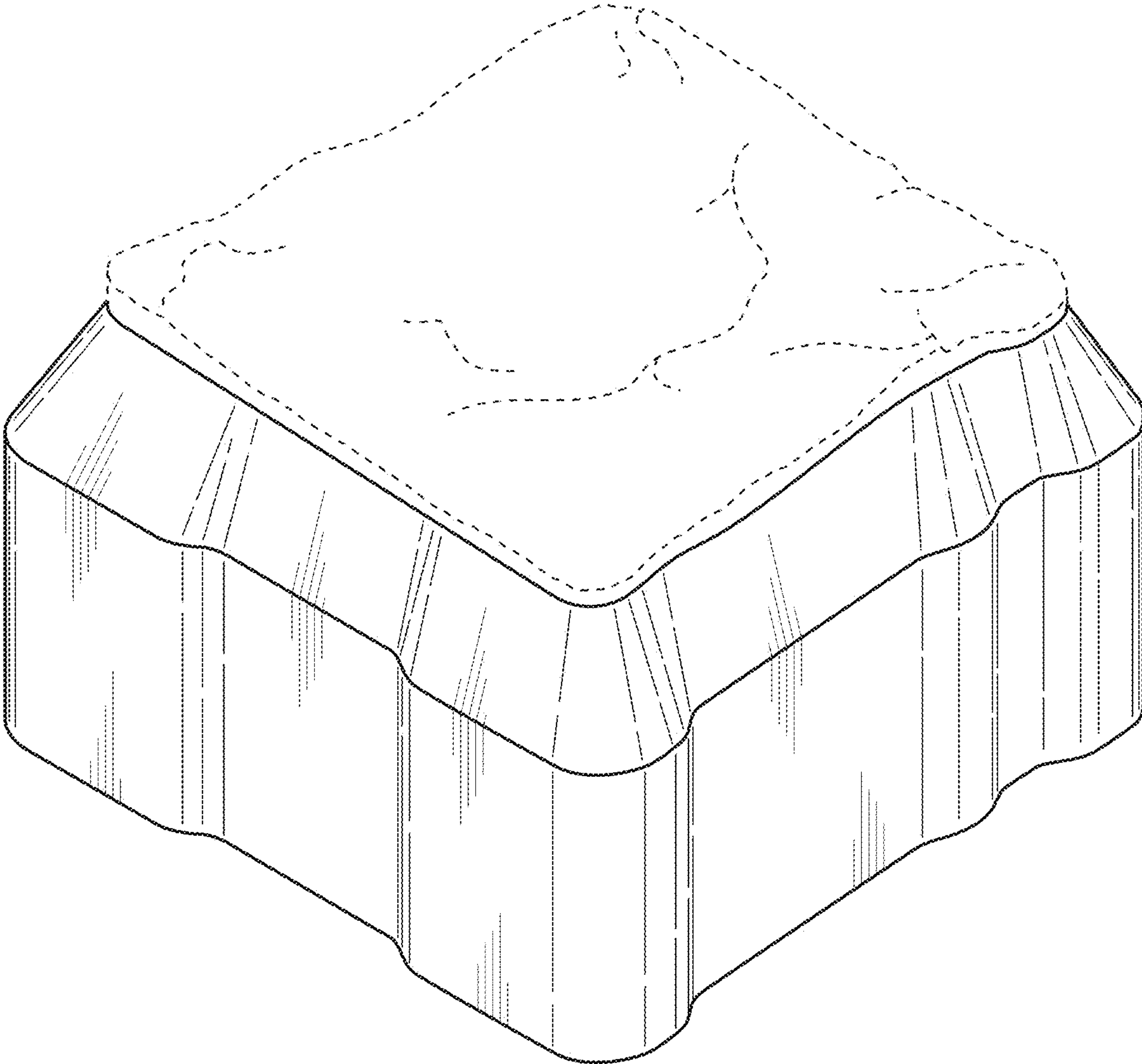

FIG. 1

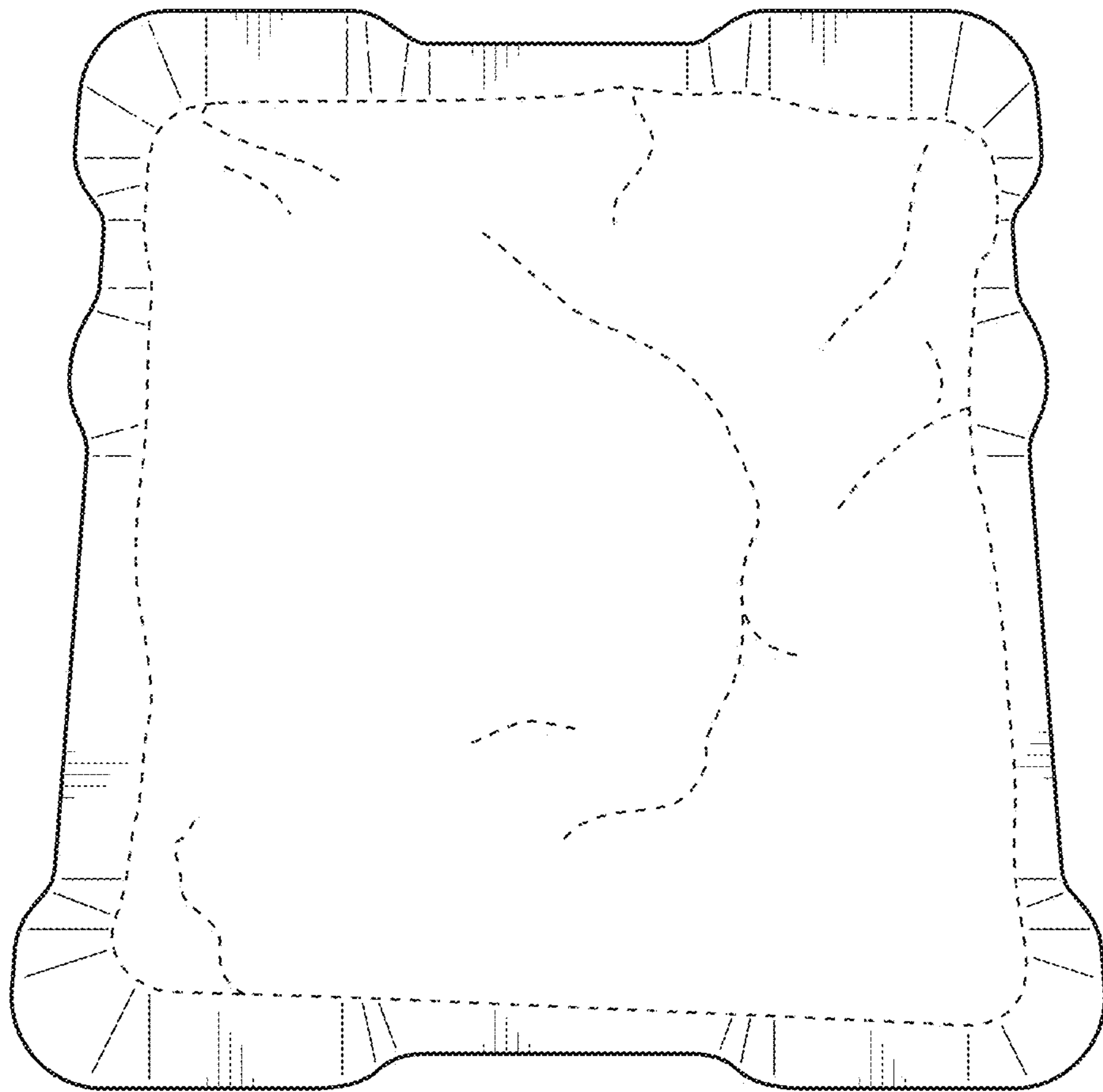

FIG. 2

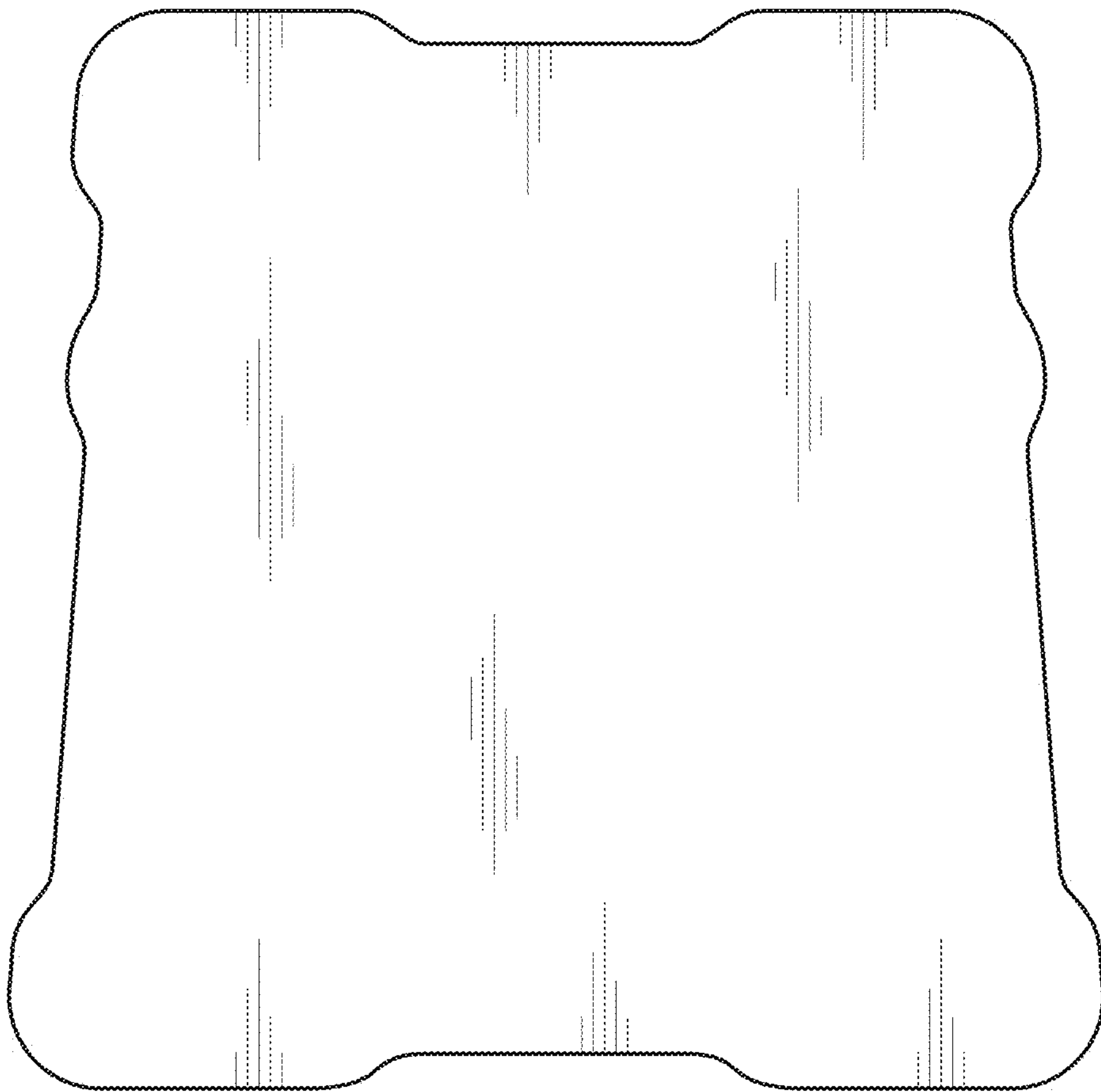

FIG. 3

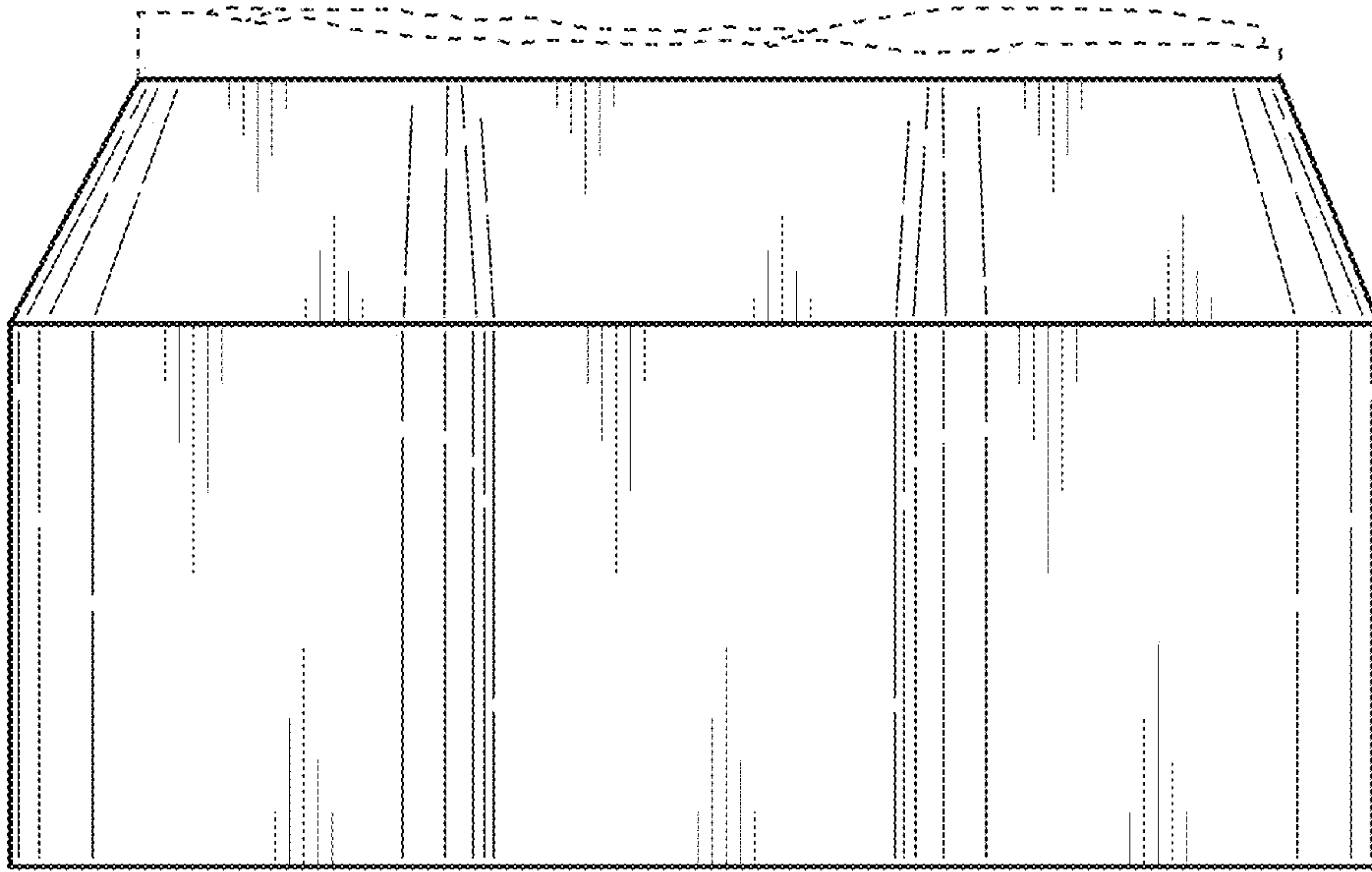

FIG. 4

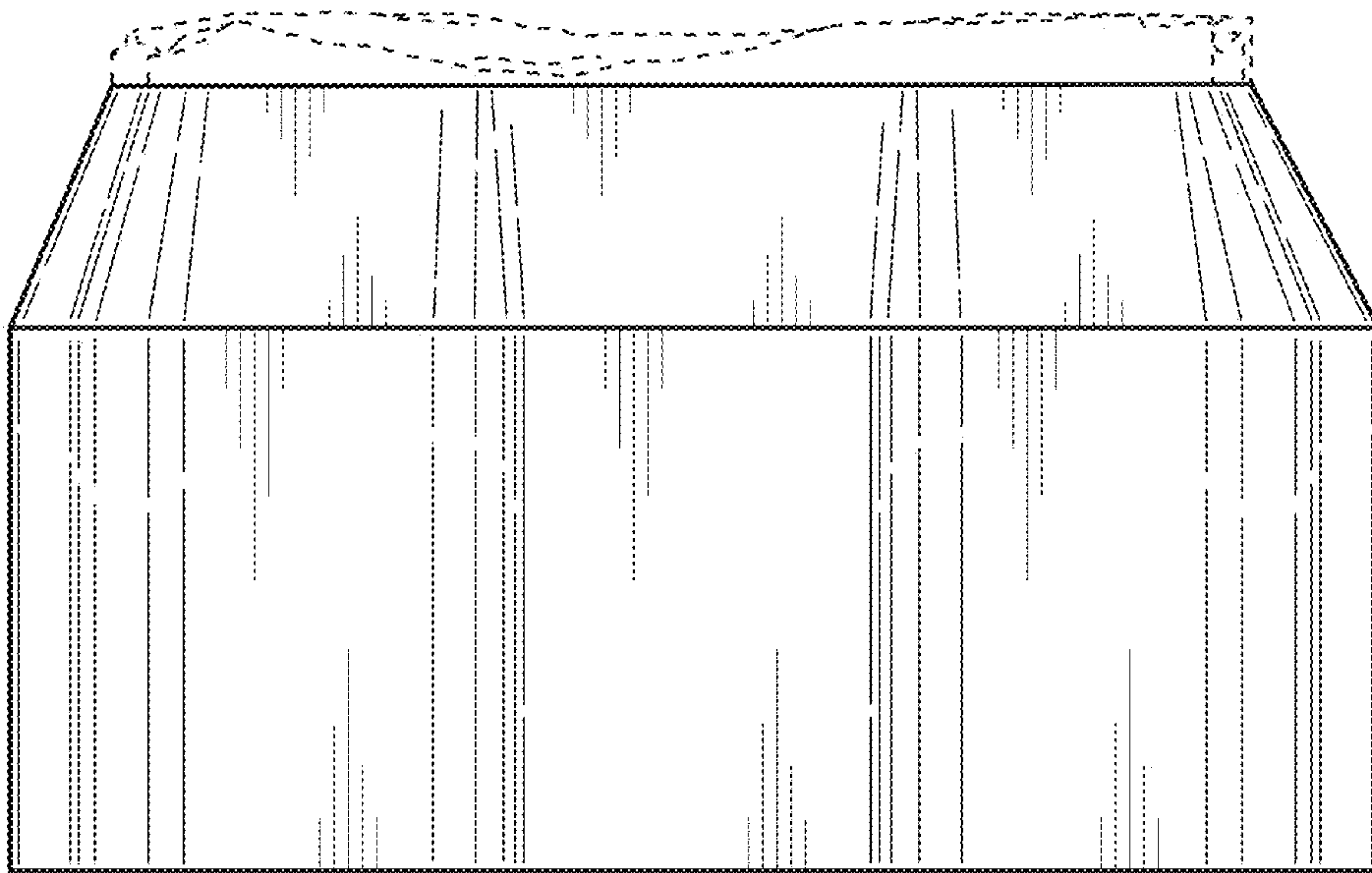

FIG. 5

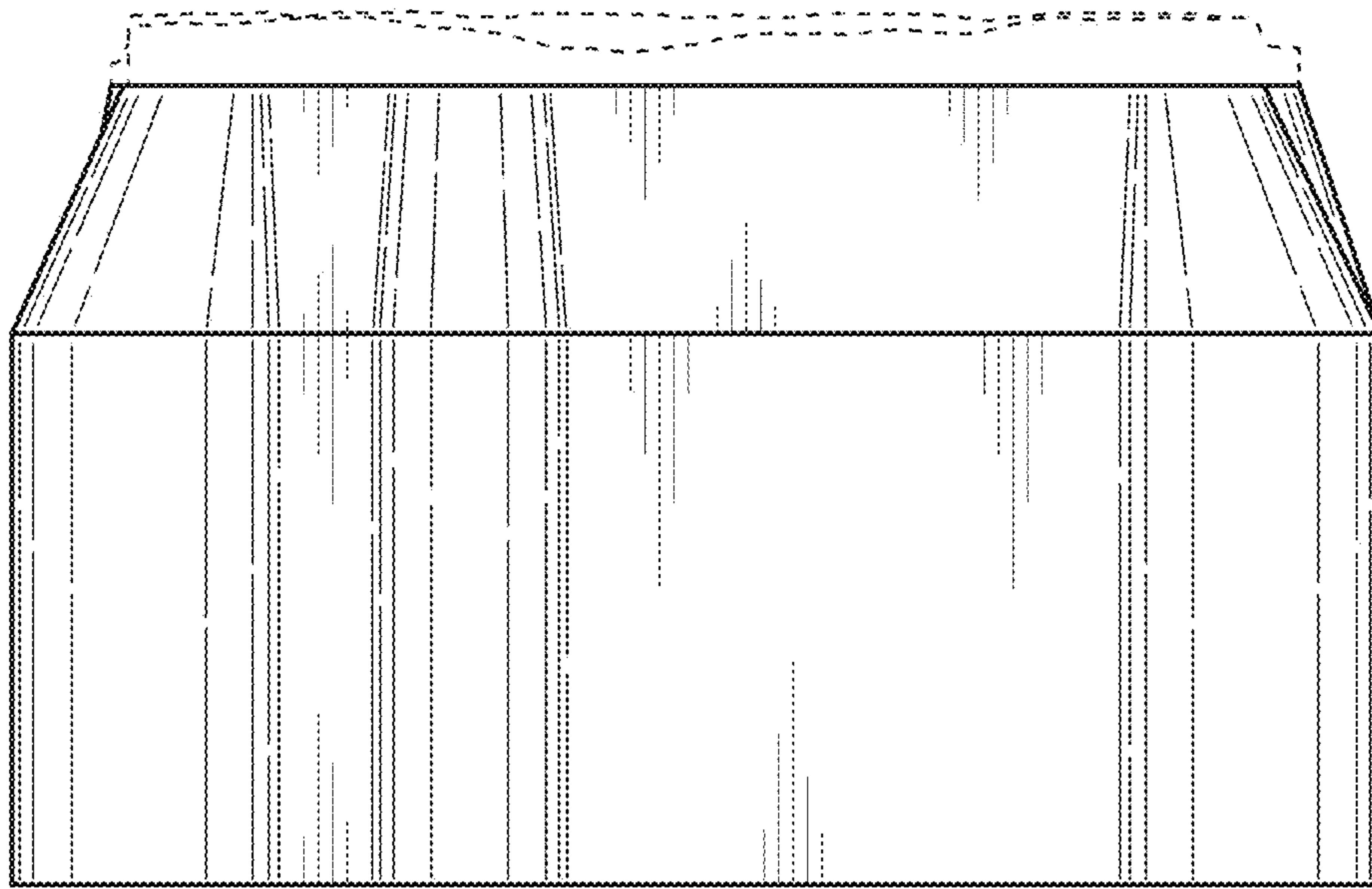

FIG. 6

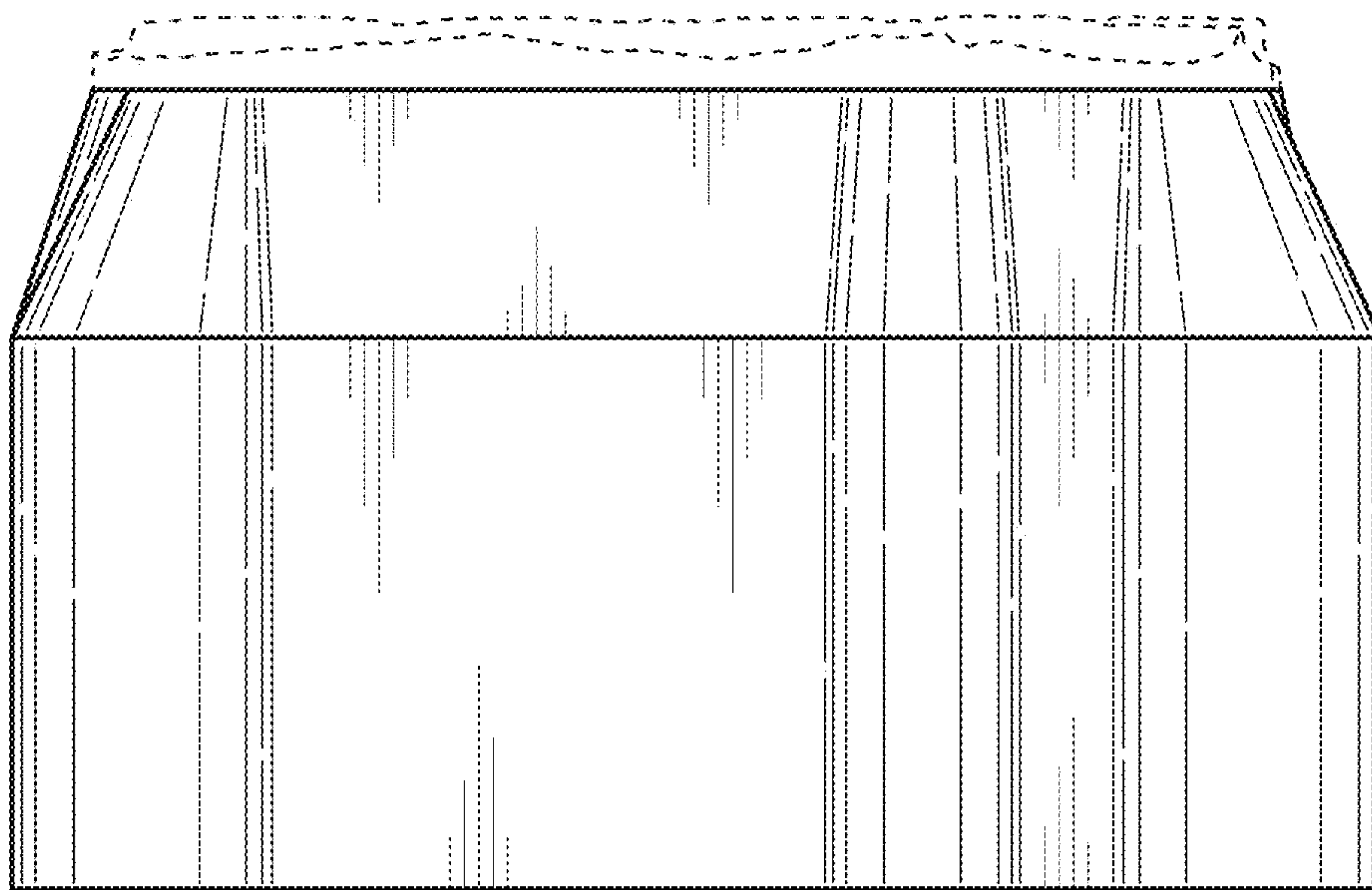

FIG. 7

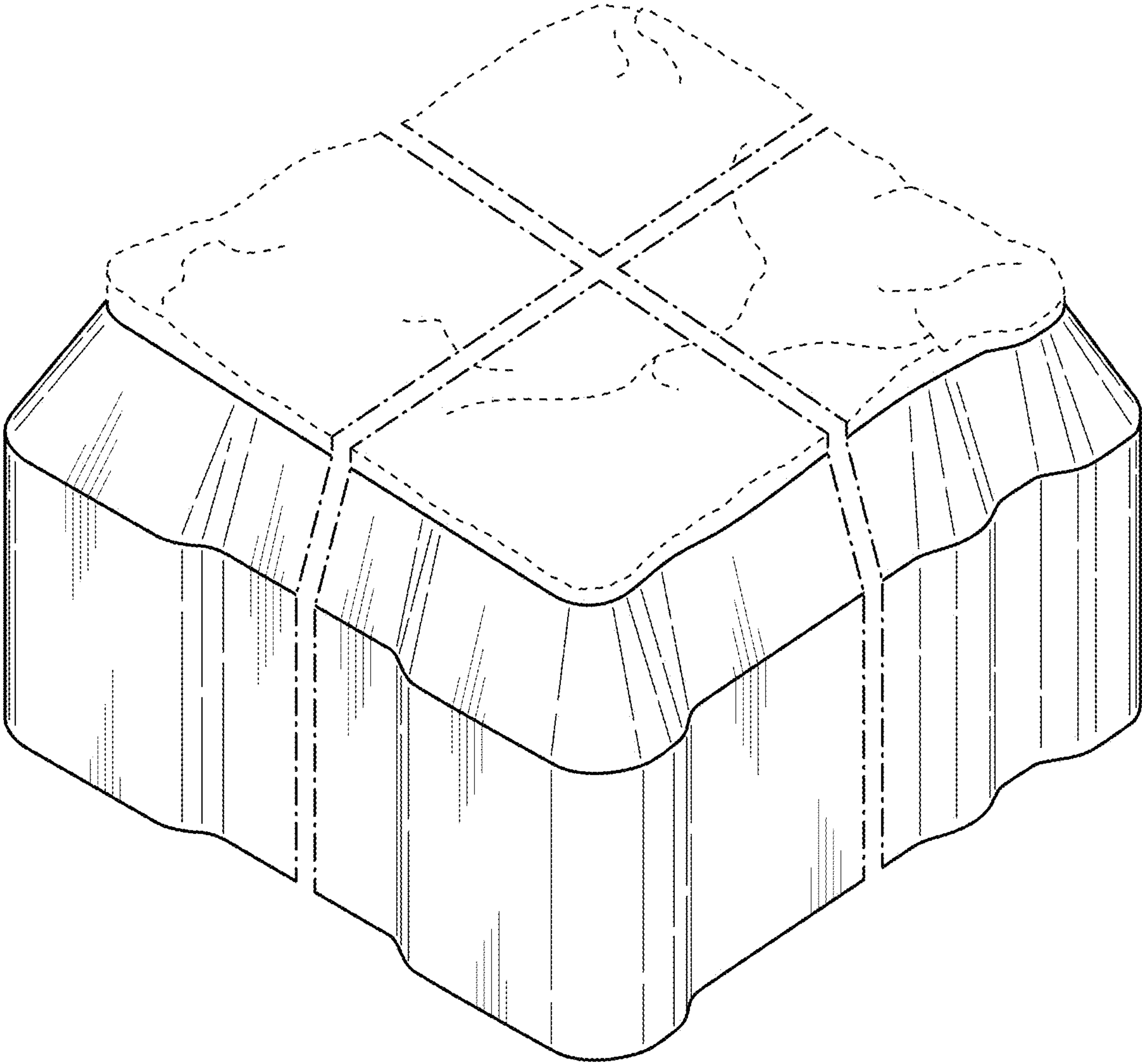

FIG. 8

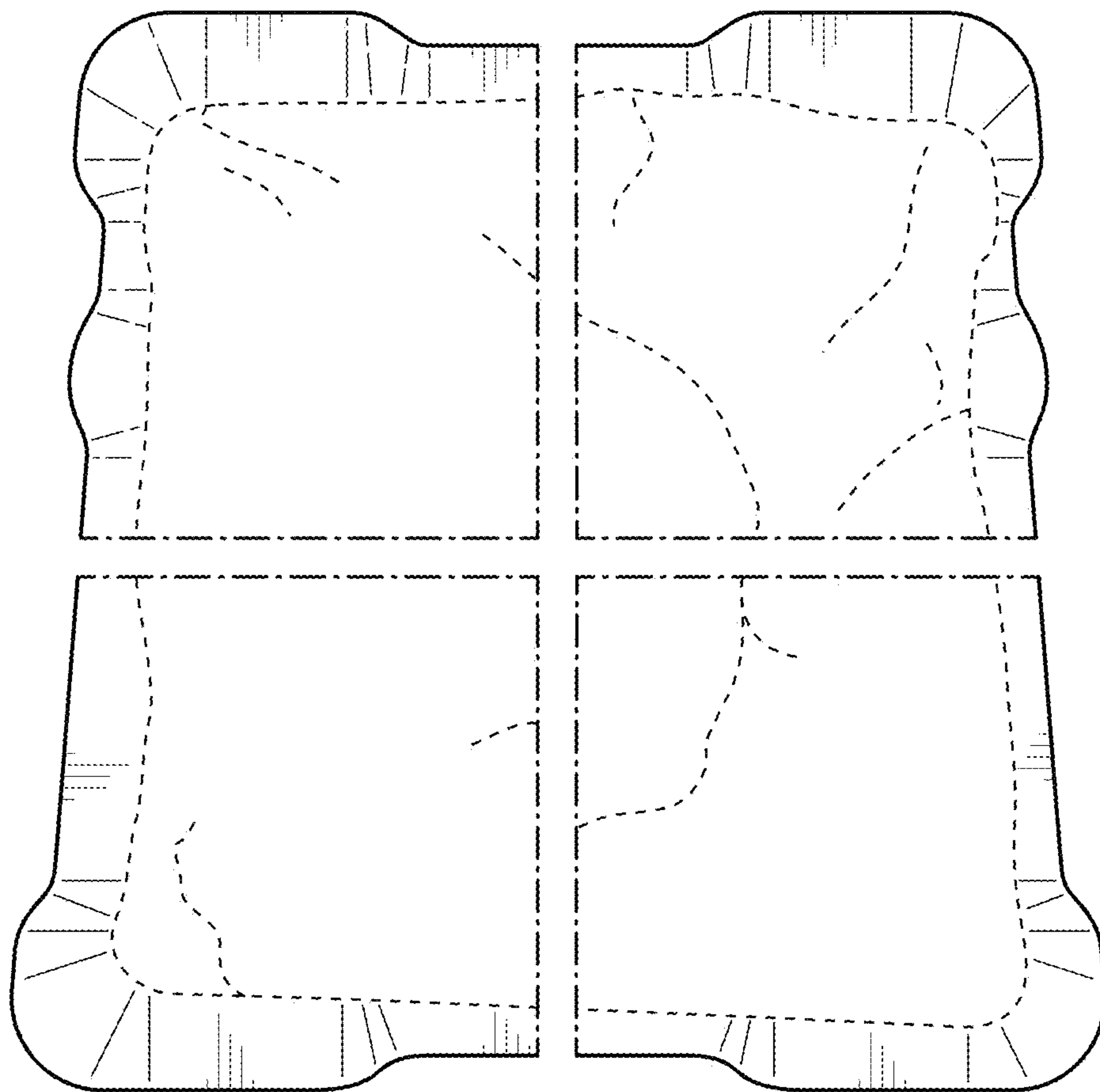

FIG. 9

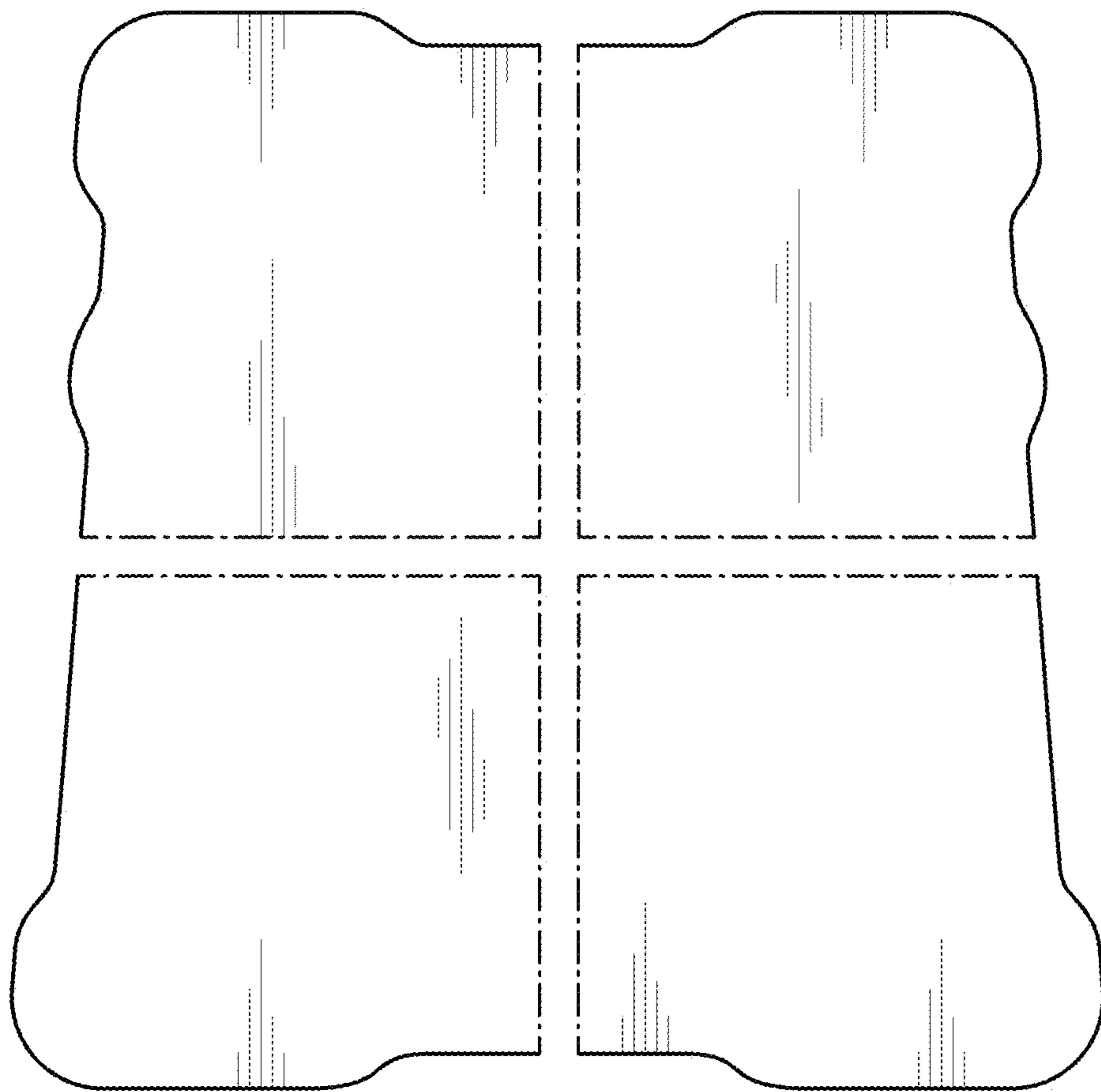

FIG. 10

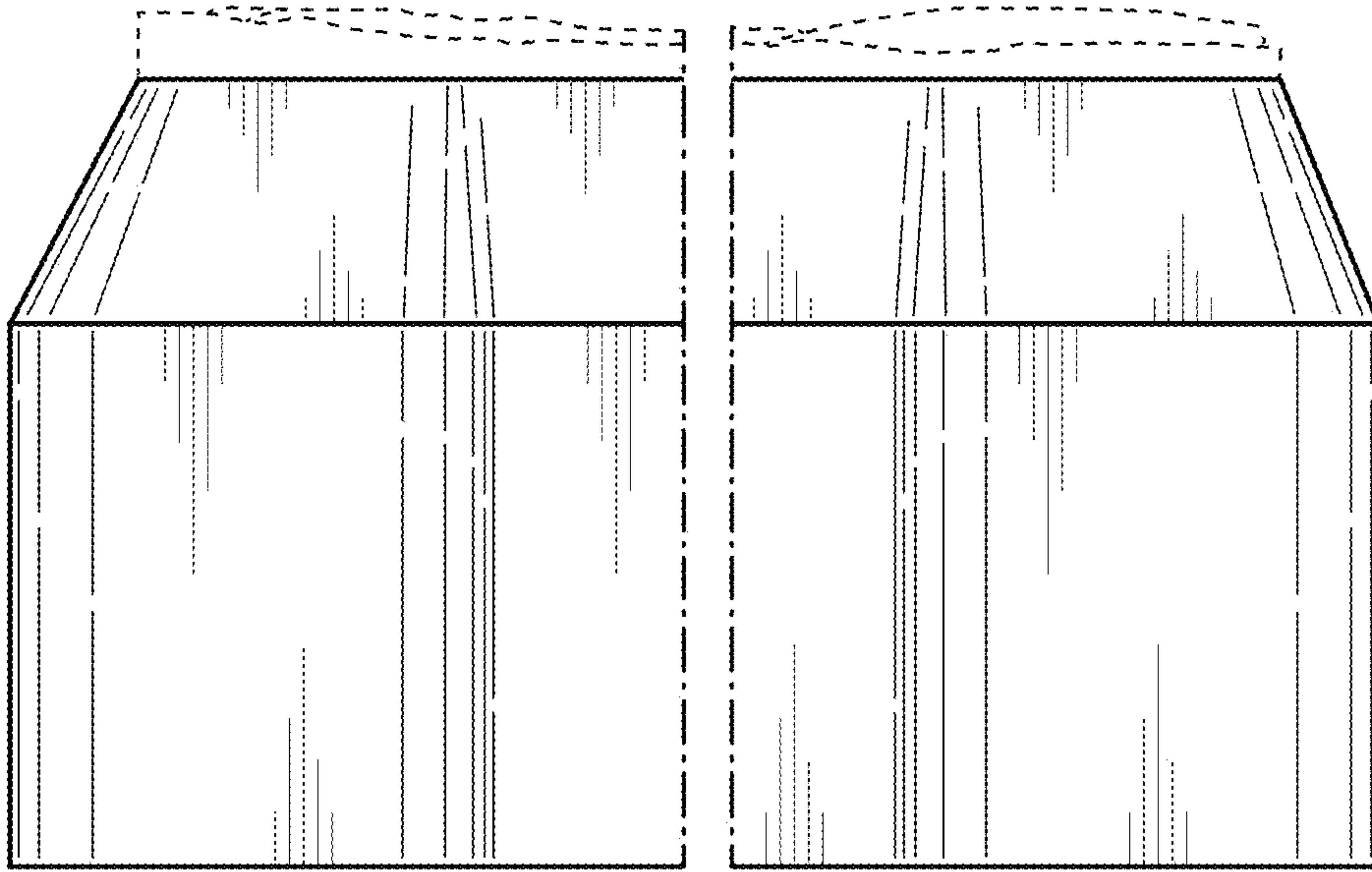

FIG. 11

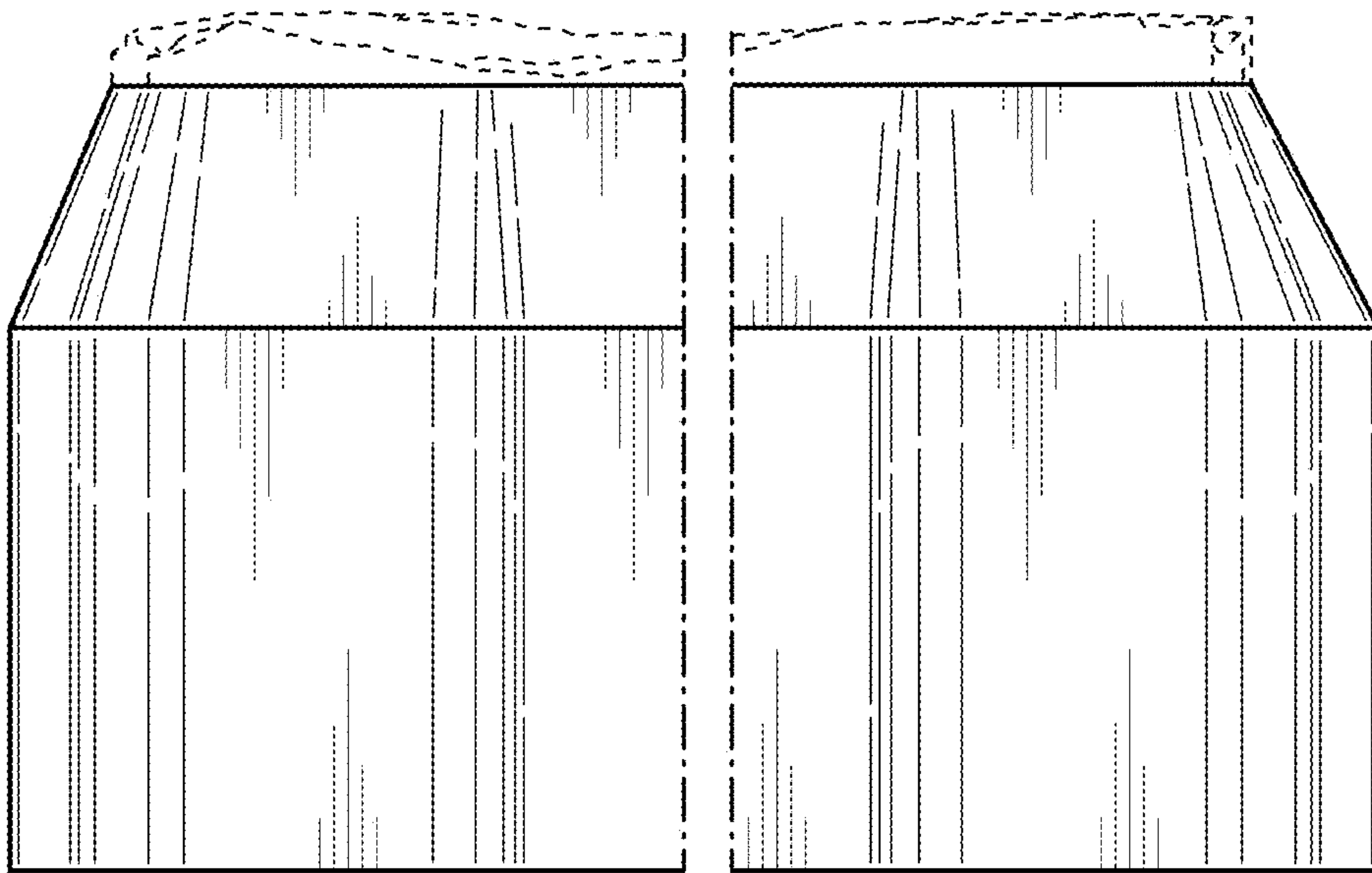

FIG. 12

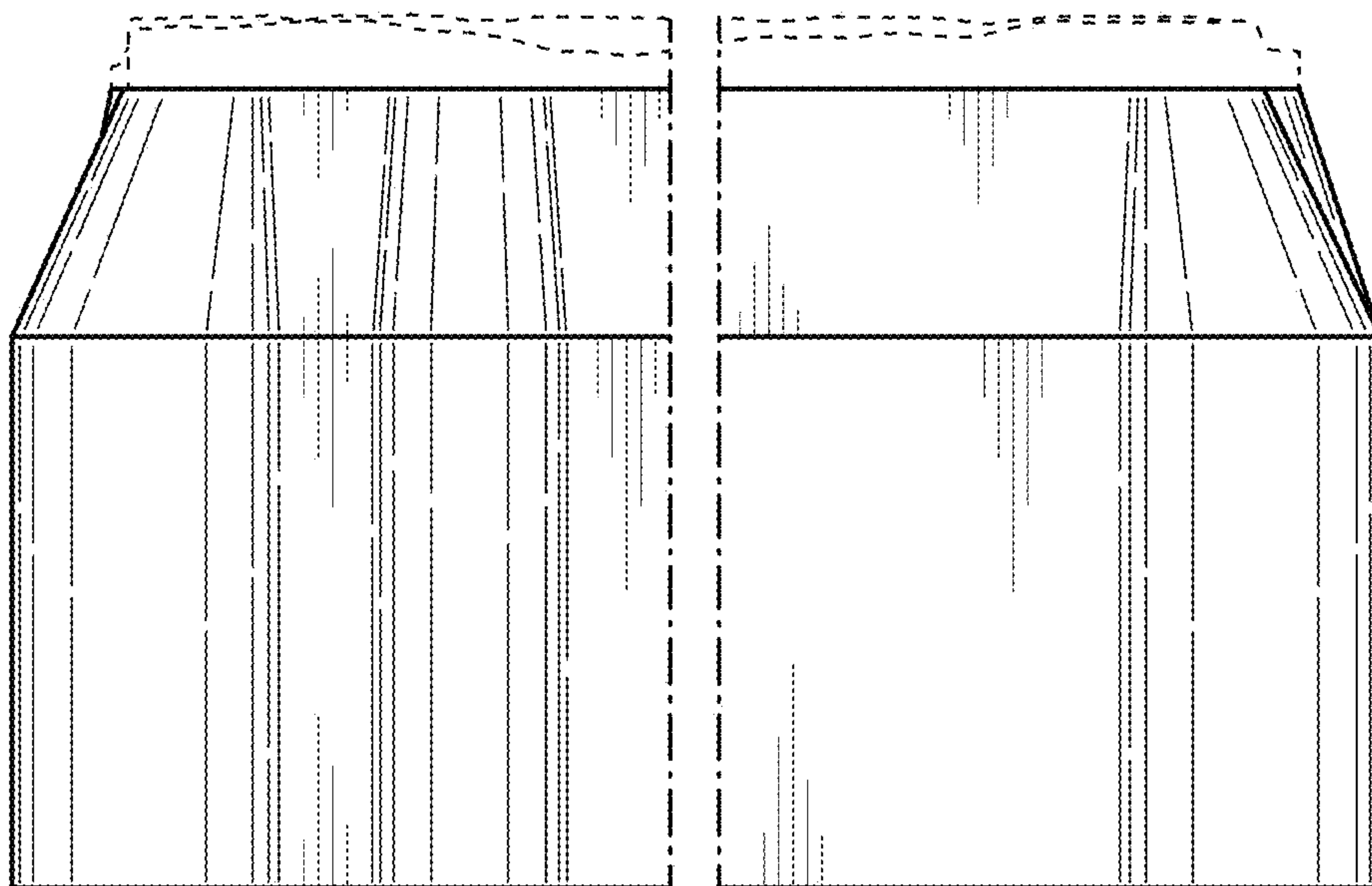

FIG. 13

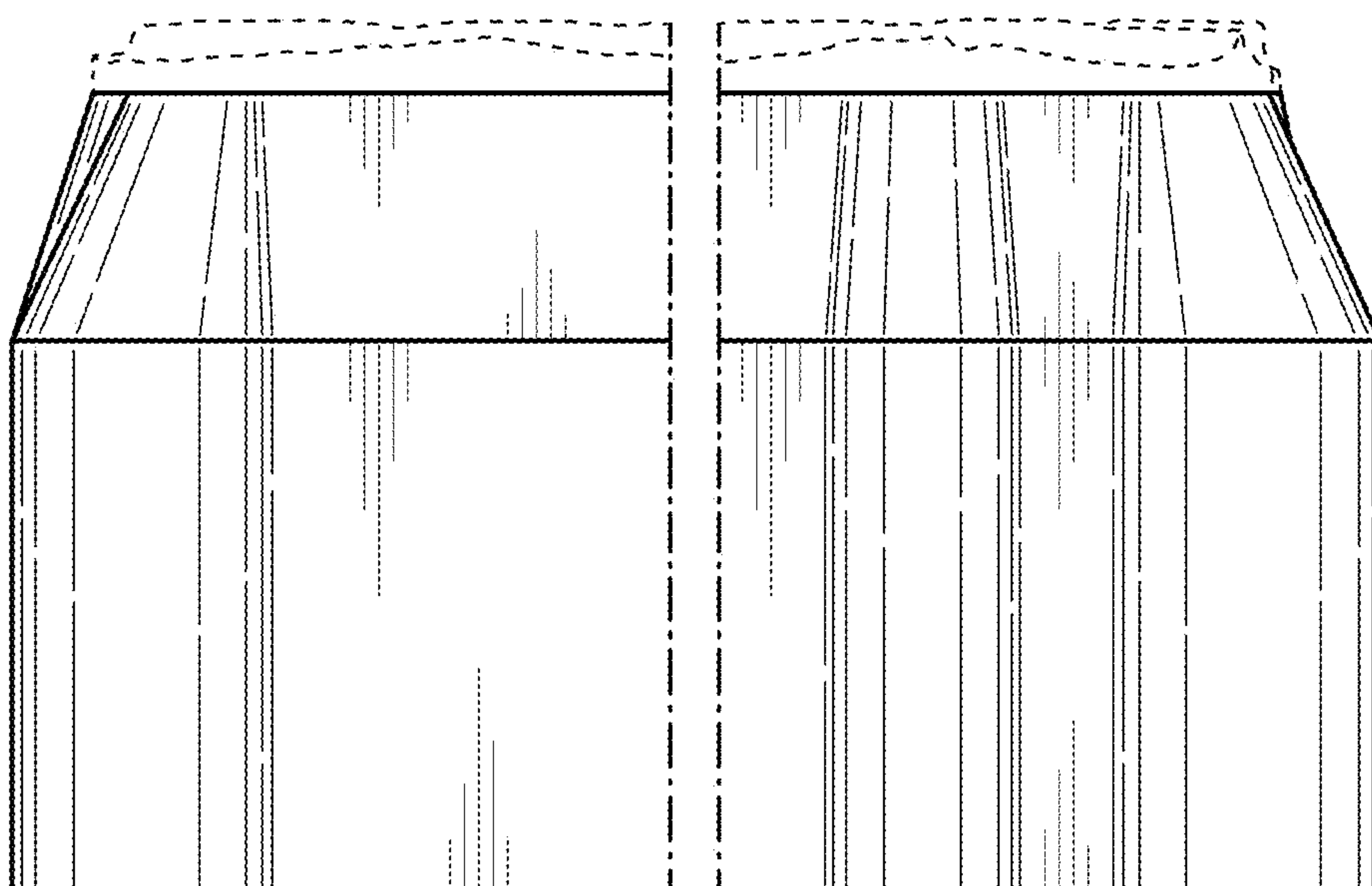

FIG. 14