



US00D972045S

(12) **United States Design Patent**
Huang

(10) **Patent No.:** **US D972,045 S**

(45) **Date of Patent:** **** Dec. 6, 2022**

(54) **RADISH PULLING TOY**

(71) Applicant: **Jinjian Huang, Yunhe (CN)**

(72) Inventor: **Jinjian Huang, Yunhe (CN)**

(**) Term: **15 Years**

(21) Appl. No.: **29/789,292**

(22) Filed: **Sep. 14, 2021**

(51) **LOC (13) Cl.** **21-01**

(52) **U.S. Cl.**
USPC **D21/468**

(58) **Field of Classification Search**
USPC D21/398, 401, 402, 405, 407, 409, 404,
D21/425, 455, 468, 470, 473, 474, 475,
D21/476, 534, 535, 536, 537, 655
CPC A63H 23/00; A63H 23/10; A63H 3/14;
A63H 23/16; A63H 29/10; A63H 29/14;
A63H 29/12; A63H 33/00; A63H 33/006;
A63H 33/28; A63H 33/42
See application file for complete search history.

(56) **References Cited**

U.S. PATENT DOCUMENTS

D141,091 S *	5/1945	Colble	D21/455
D141,514 S *	6/1945	Wolf	D21/455
D351,631 S *	10/1994	Thomsen	D21/485
D373,744 S *	9/1996	Wotton	D21/655
D513,283 S *	12/2005	Wampler	D21/562
D523,492 S *	6/2006	Saruhashi	D21/660
D722,887 S *	2/2015	Zwettler	D21/655
D764,743 S *	8/2016	Ortiz	D21/300
D794,133 S *	8/2017	Ostergaard	D21/425
D818,054 S *	5/2018	McLachlan	D21/468
D826,497 S *	8/2018	Smith	D32/40
D840,476 S *	2/2019	Sheldon	D21/513

D879,205 S *	3/2020	Ostergaard	D21/425
D894,295 S *	8/2020	Zhou	D21/468
D910,776 S *	2/2021	Chen	D21/474
D924,337 S *	7/2021	Sakai	D21/535

* cited by examiner

Primary Examiner — Mehri F Bajoul

(74) *Attorney, Agent, or Firm* — Rumit R. Kanakia

(57) **CLAIM**

The ornamental design for a radish pulling toy, as shown and described.

DESCRIPTION

FIG. 1 is a front left bottom perspective view of a radish pulling toy, showing the wagon, removable radishes and fruit components separately for ease of illustration; FIG. 2 is a bottom right top perspective view thereof; FIG. 3 is a front elevational view thereof; FIG. 4 is a back elevational view thereof; FIG. 5 is a left side elevational view thereof; FIG. 6 is a right side elevational view thereof; FIG. 7 is a top plan view thereof; FIG. 8 is a bottom plan view thereof; FIG. 9 is a front left perspective view of the rabbit component of the radish pulling toy, shown separately for ease of illustration; FIG. 10 is a back right perspective view thereof; FIG. 11 is a front elevational view thereof; FIG. 12 is a back elevational view thereof; and, FIG. 13 shows the radish pulling toy, including all components, in an exploded.

The broken lines shown in the drawings depict portions of the radish pulling toy that form no part of the claimed design.

1 Claim, 13 Drawing Sheets

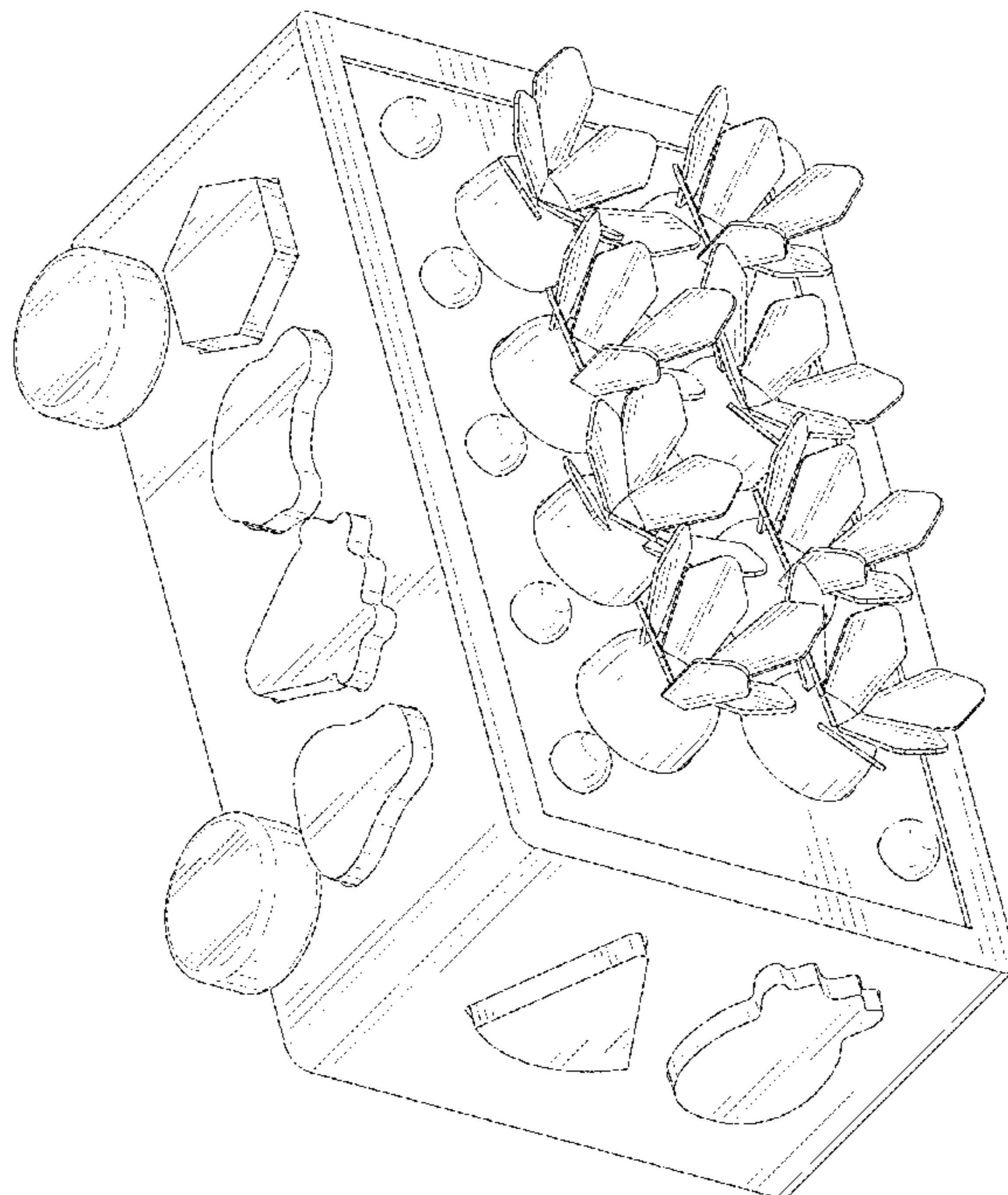

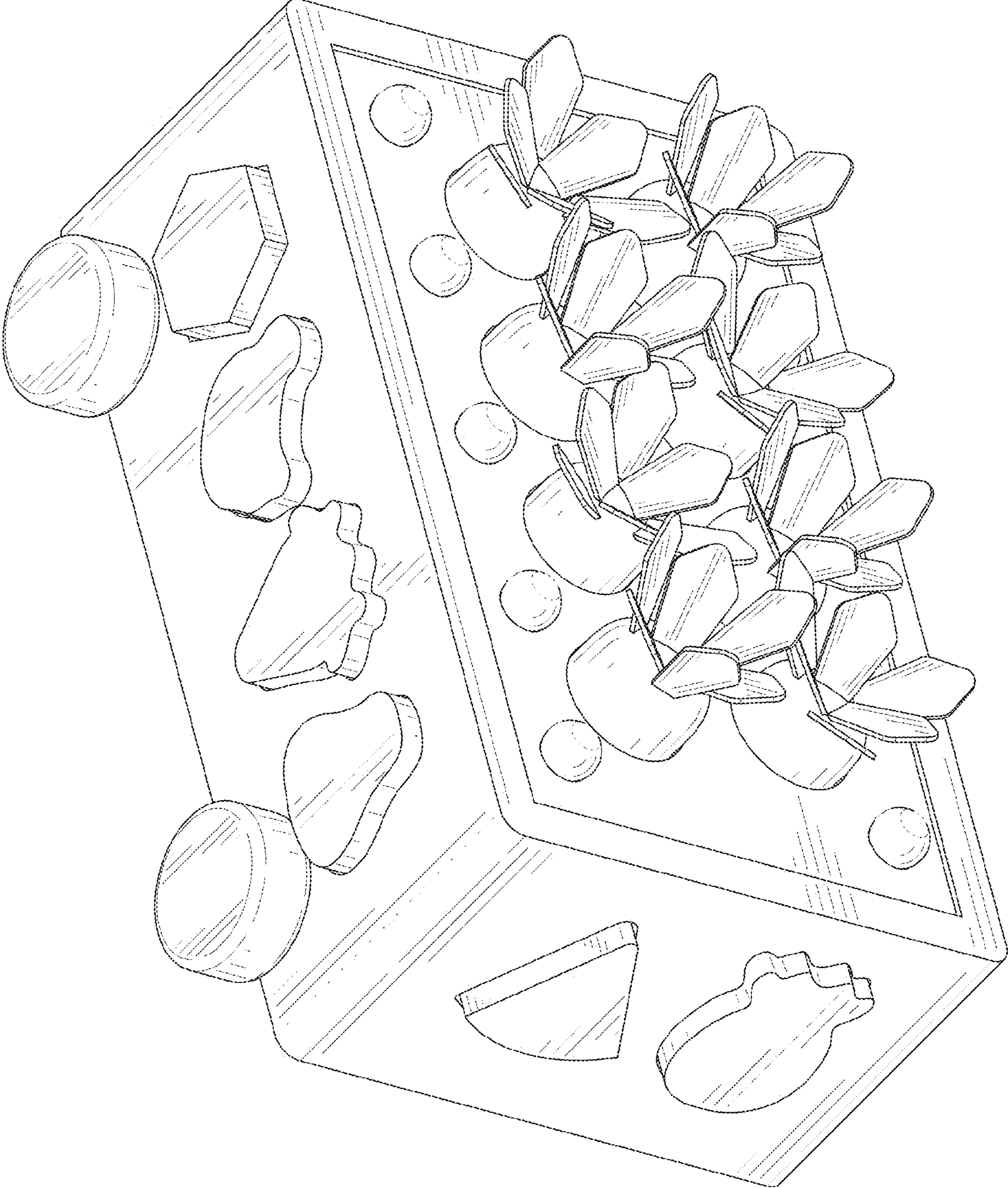

FIG. 1

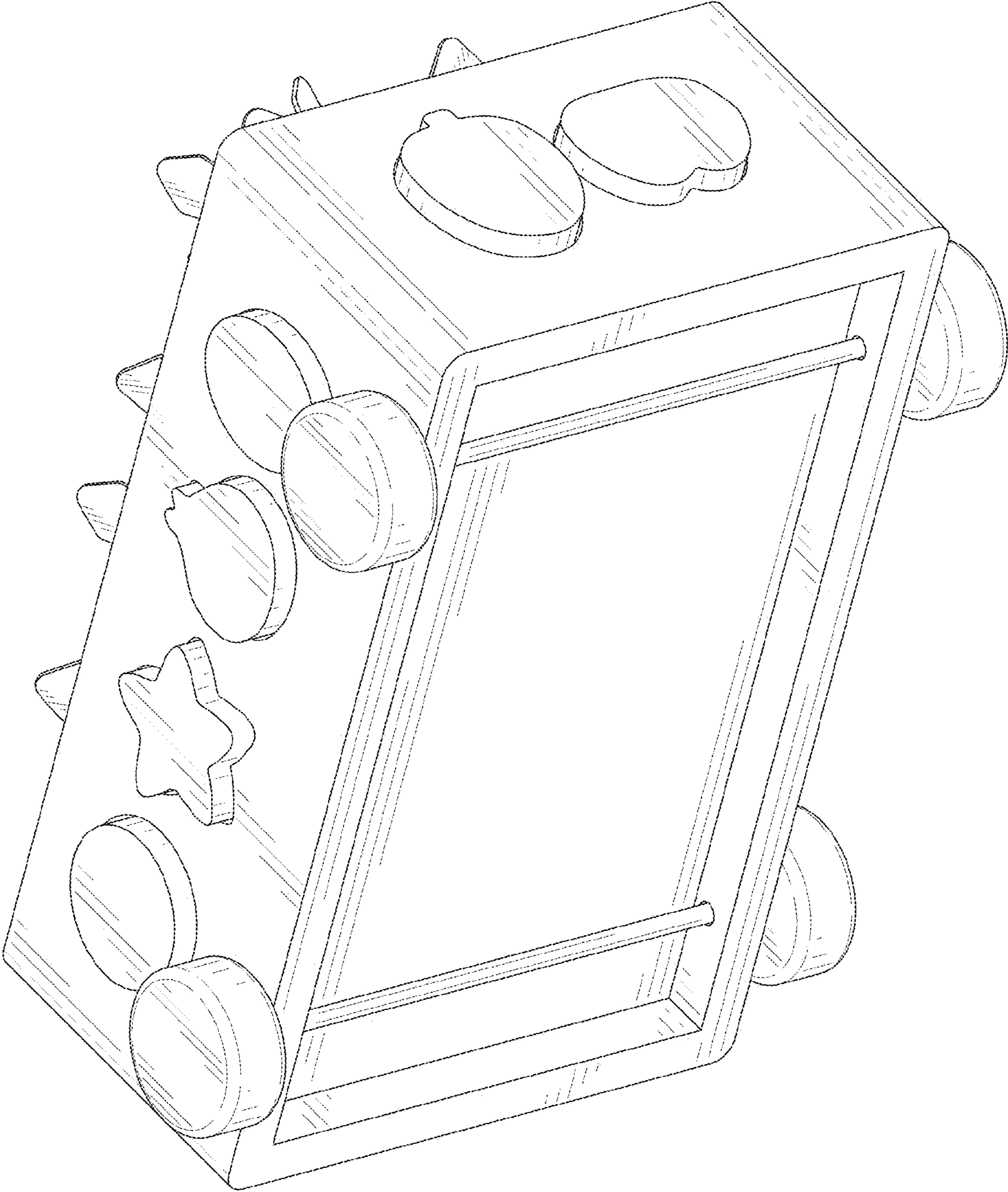

FIG. 2

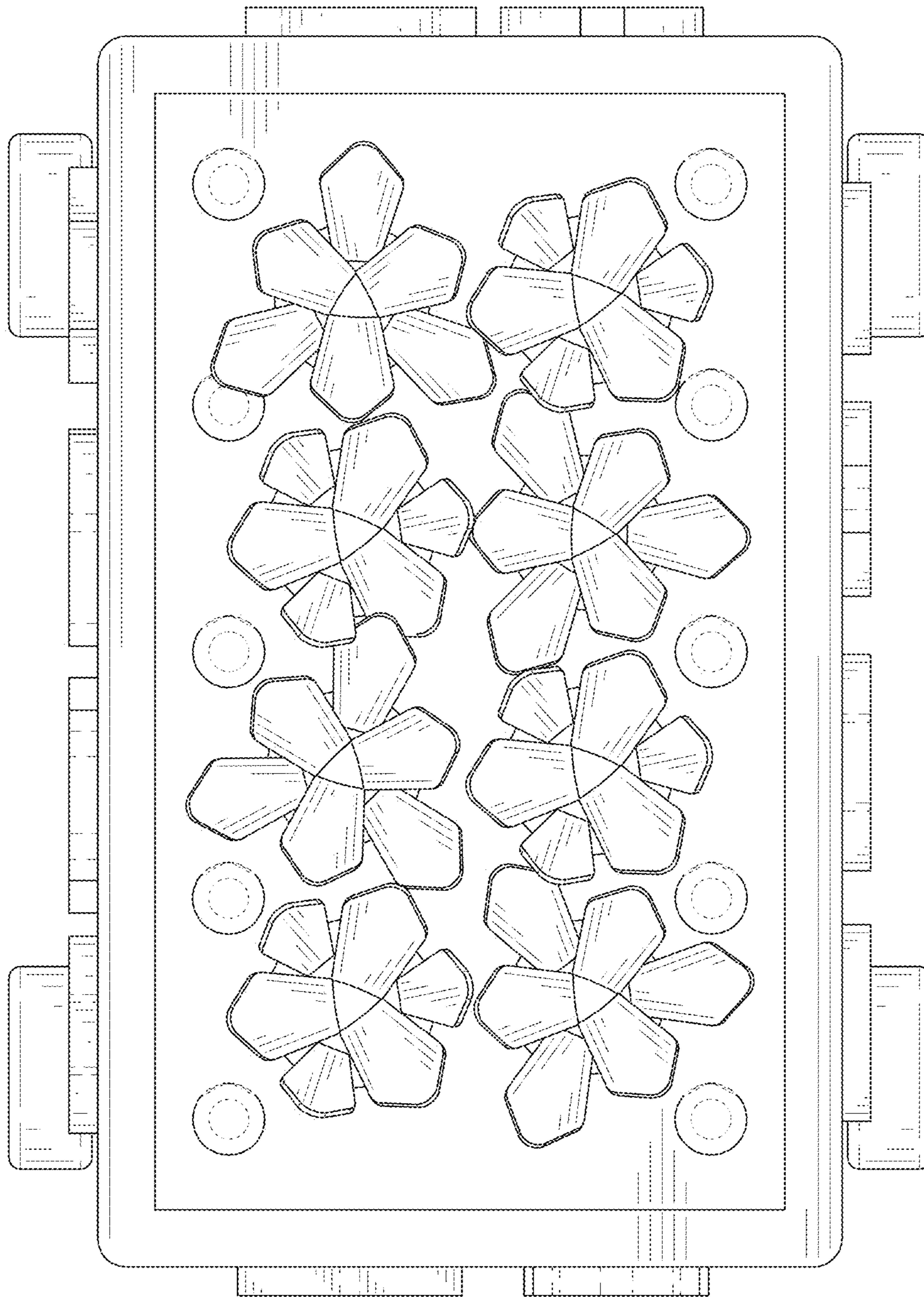

FIG. 3

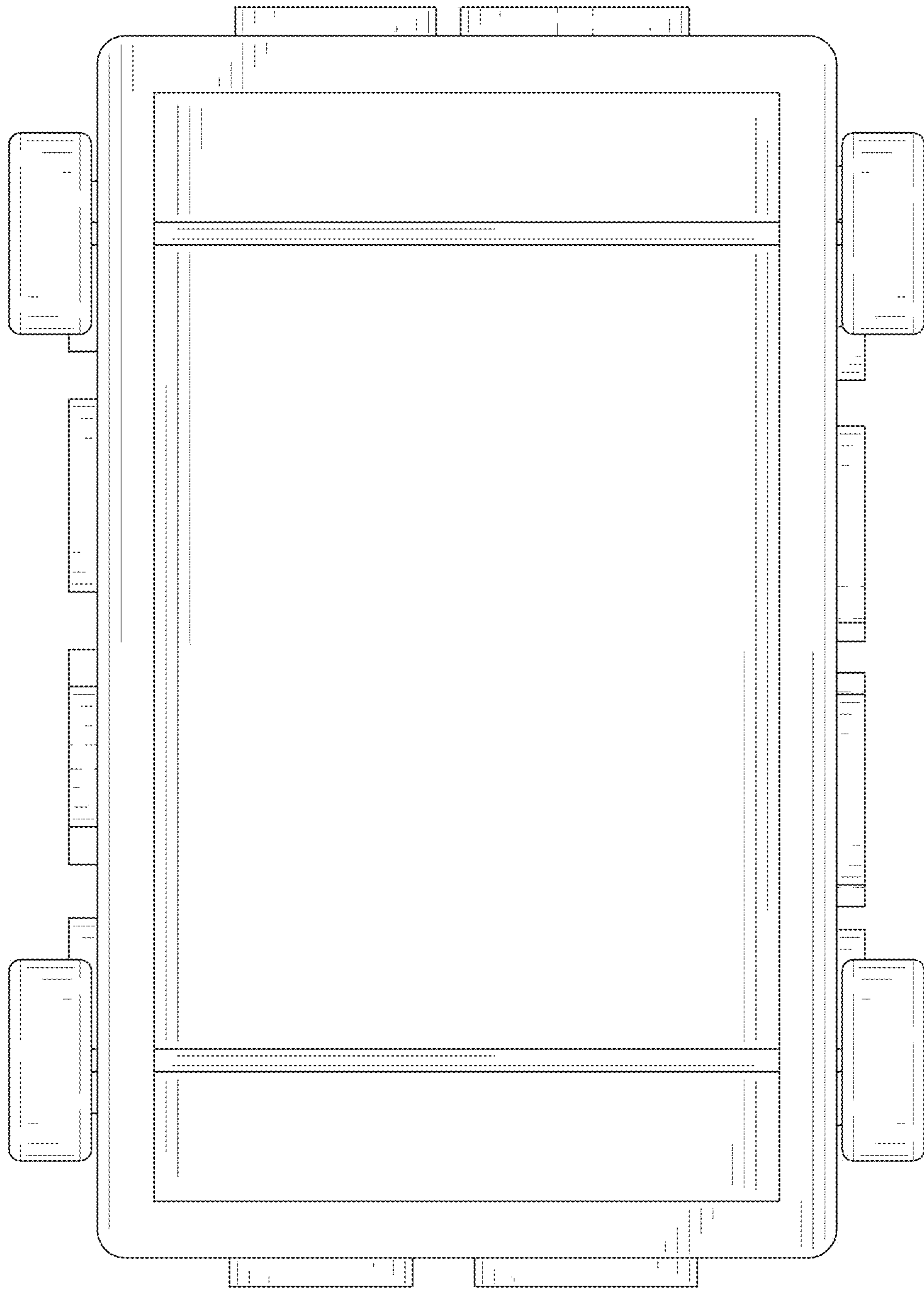

FIG. 4

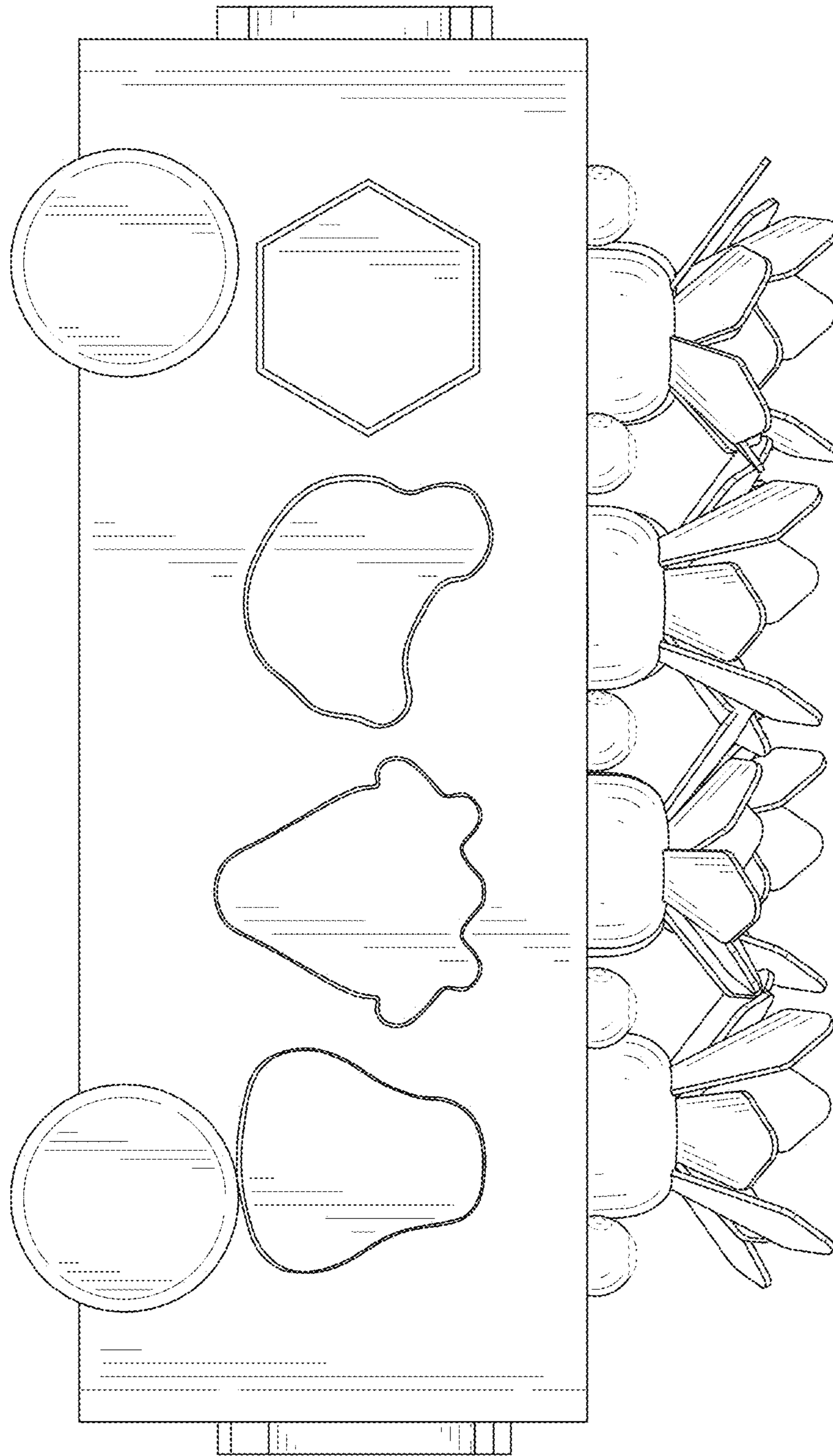

FIG. 5

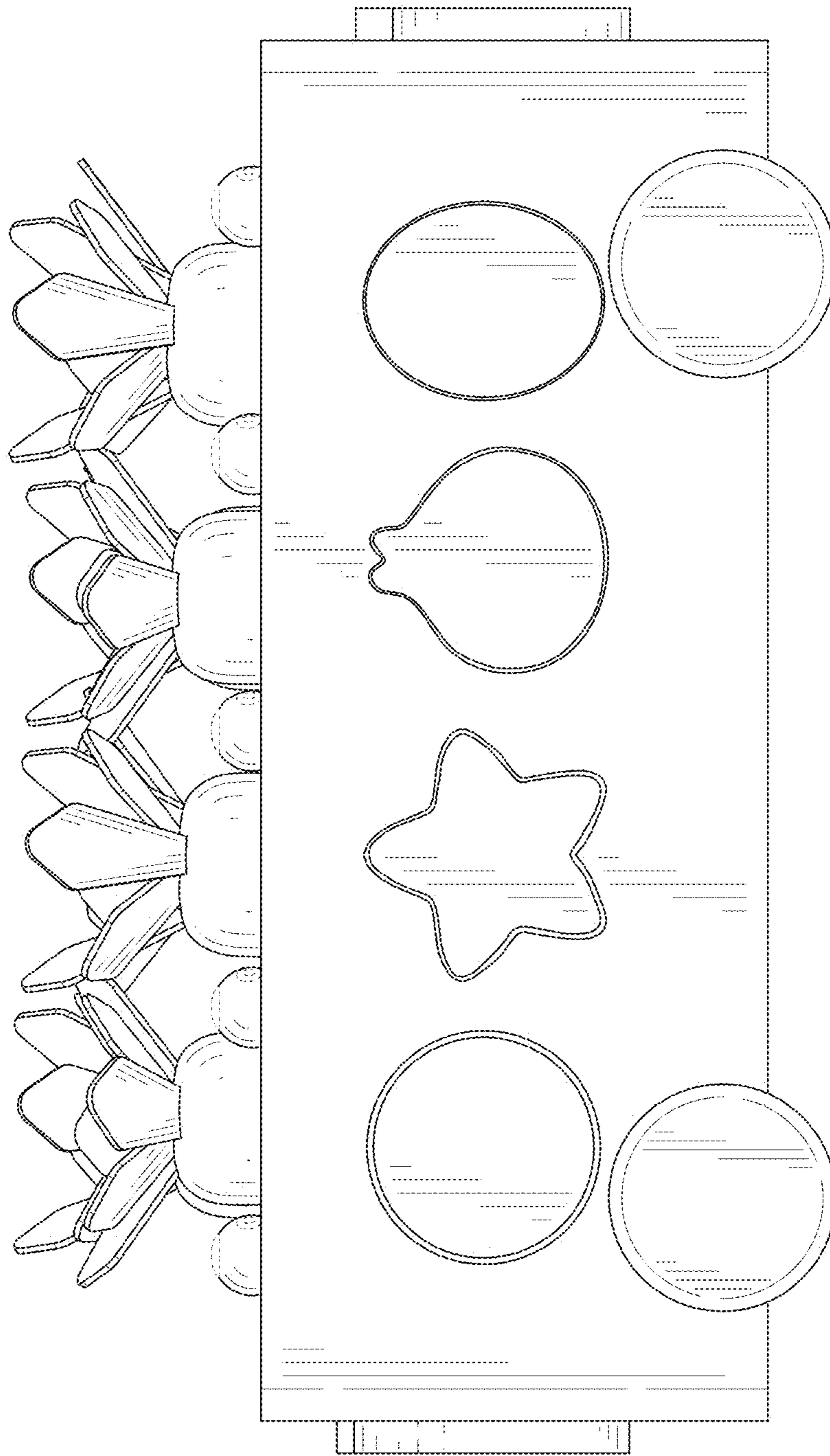

FIG. 6

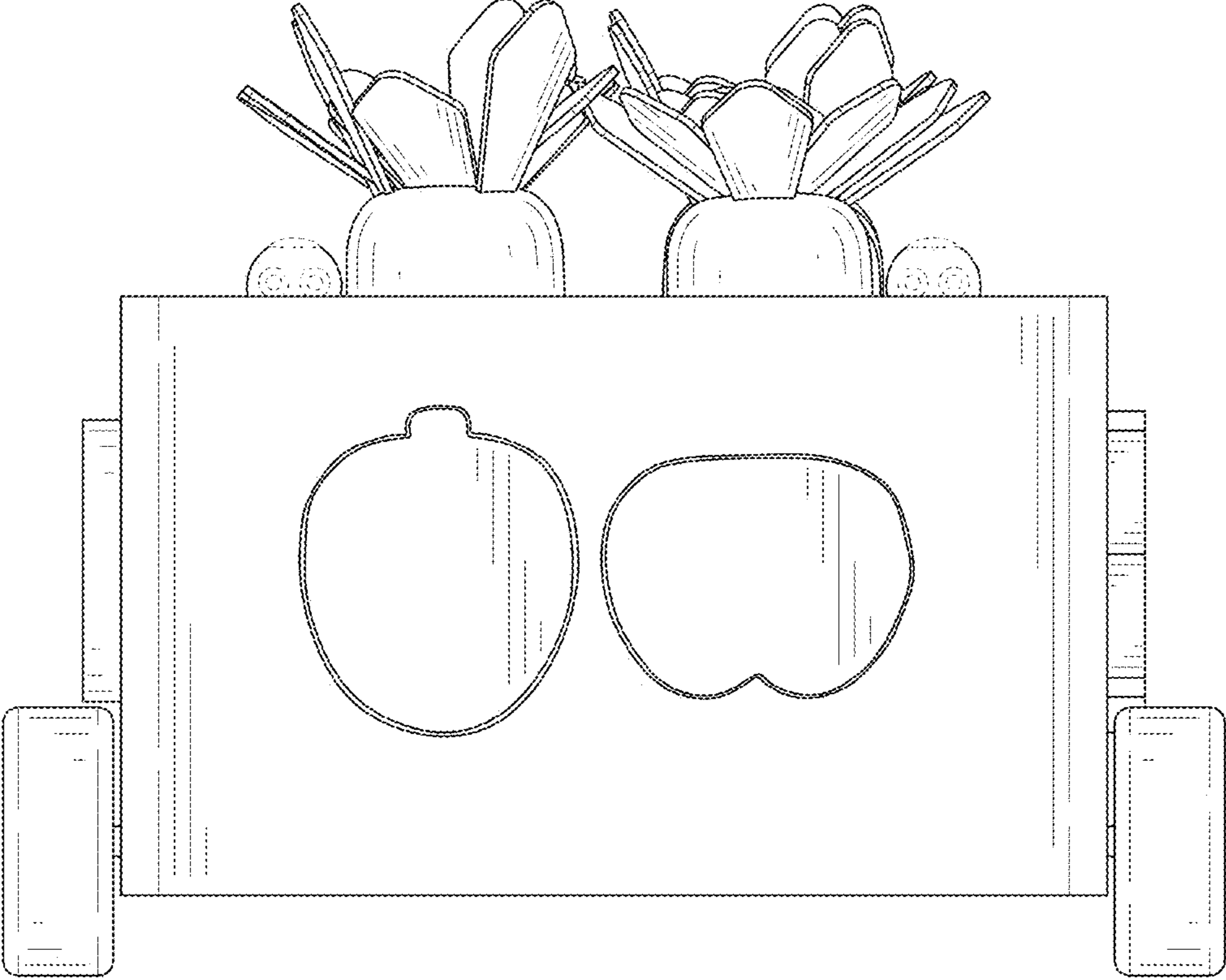

FIG. 7

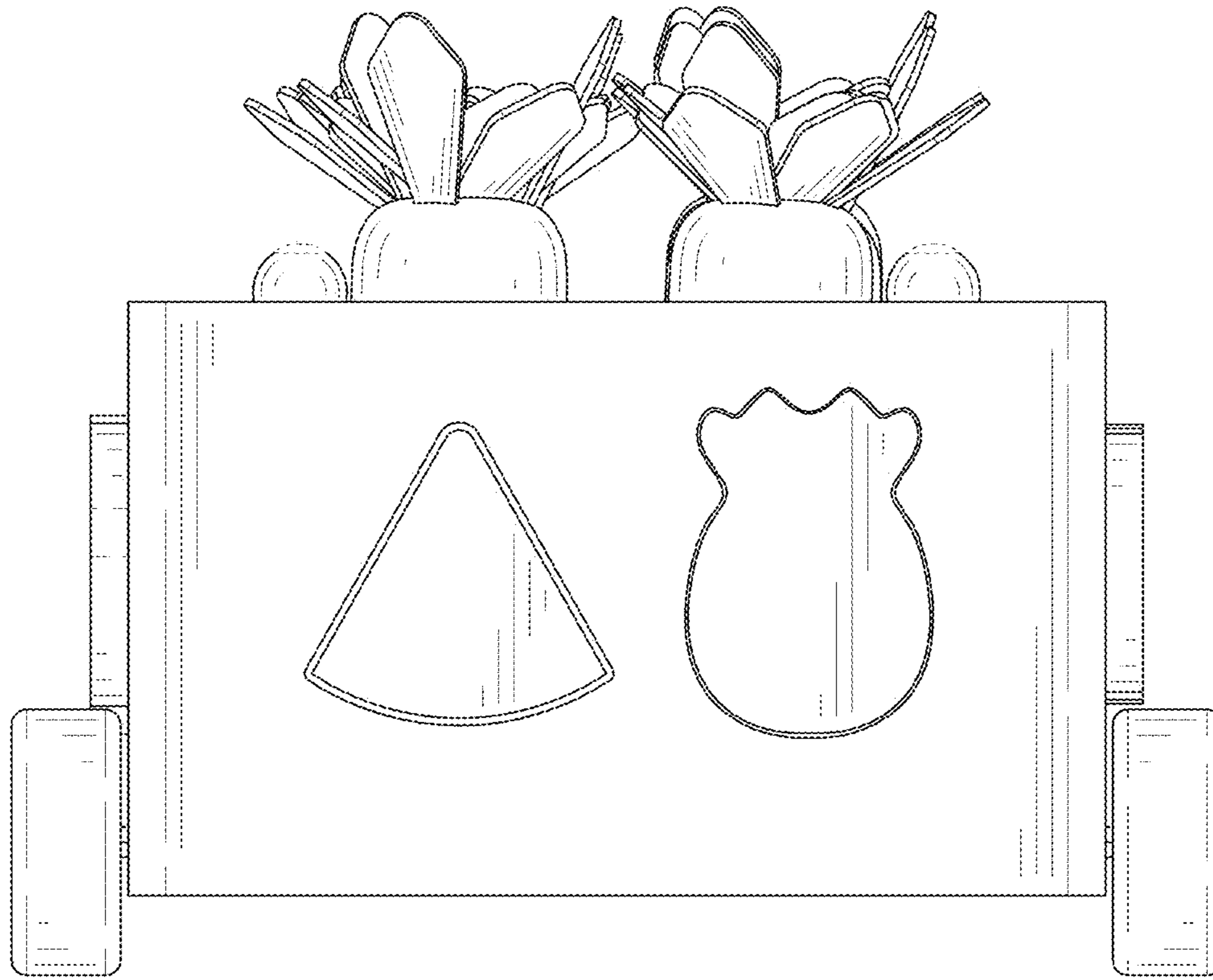

FIG. 8

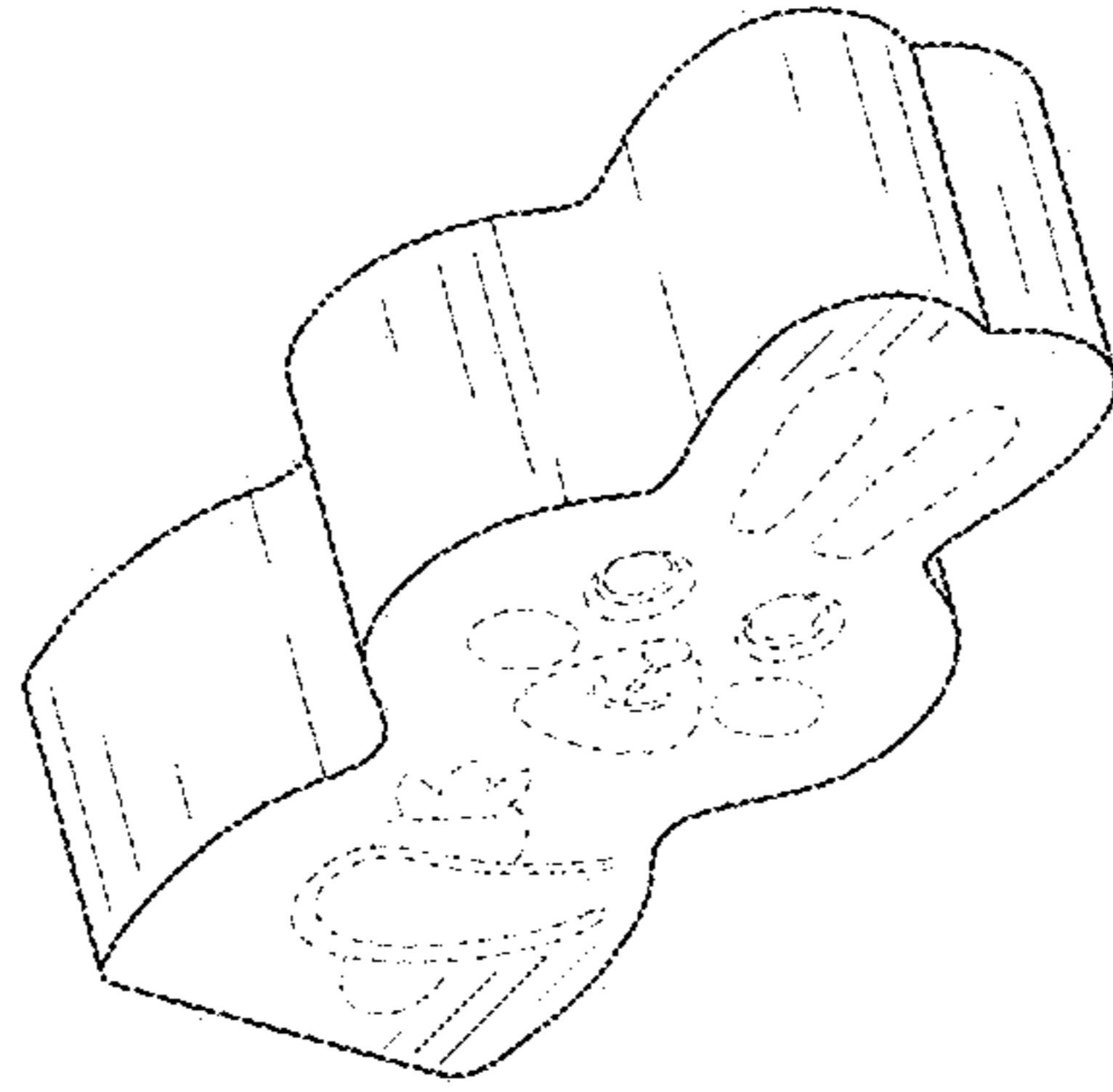

FIG. 9

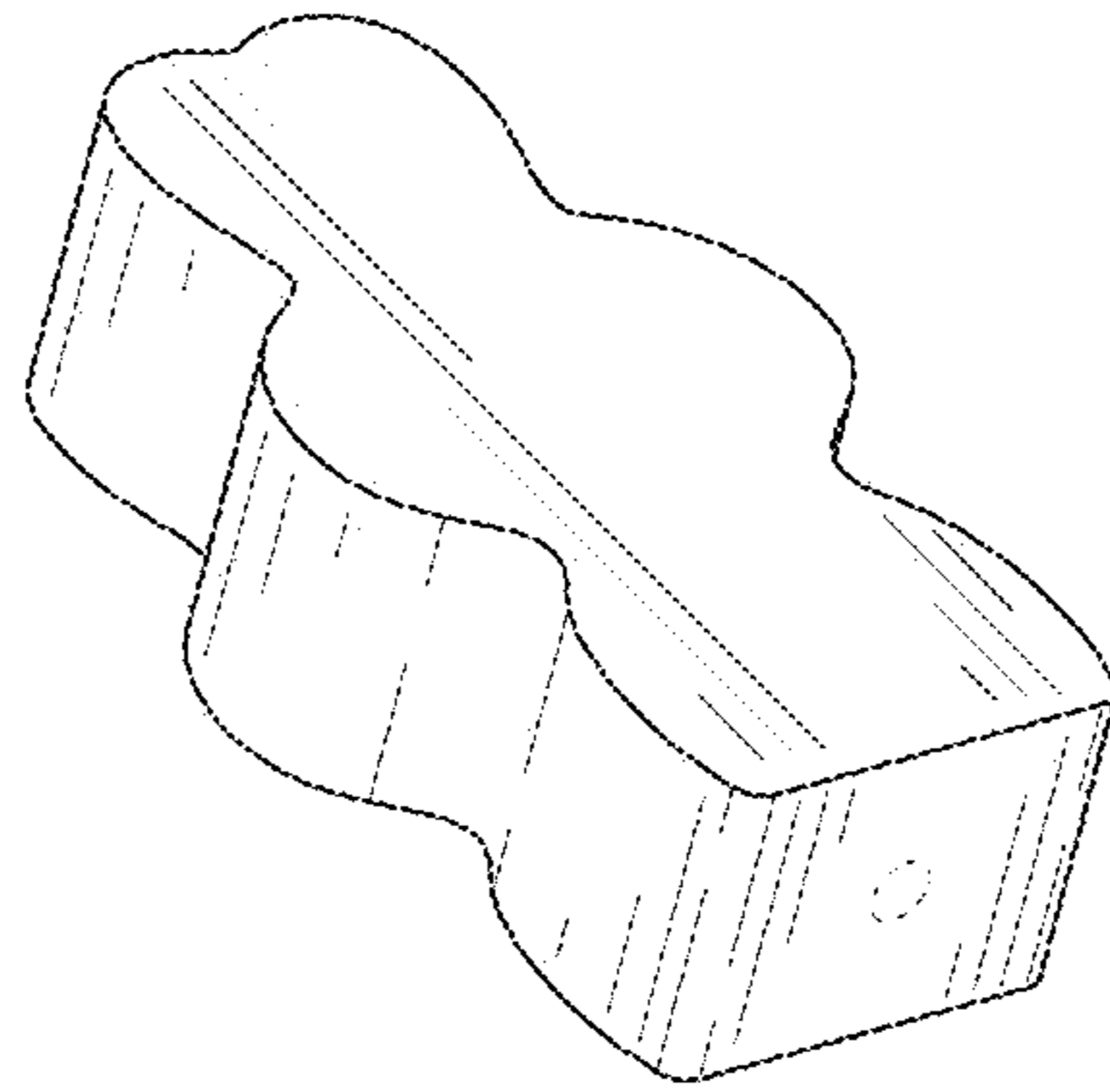

FIG. 10

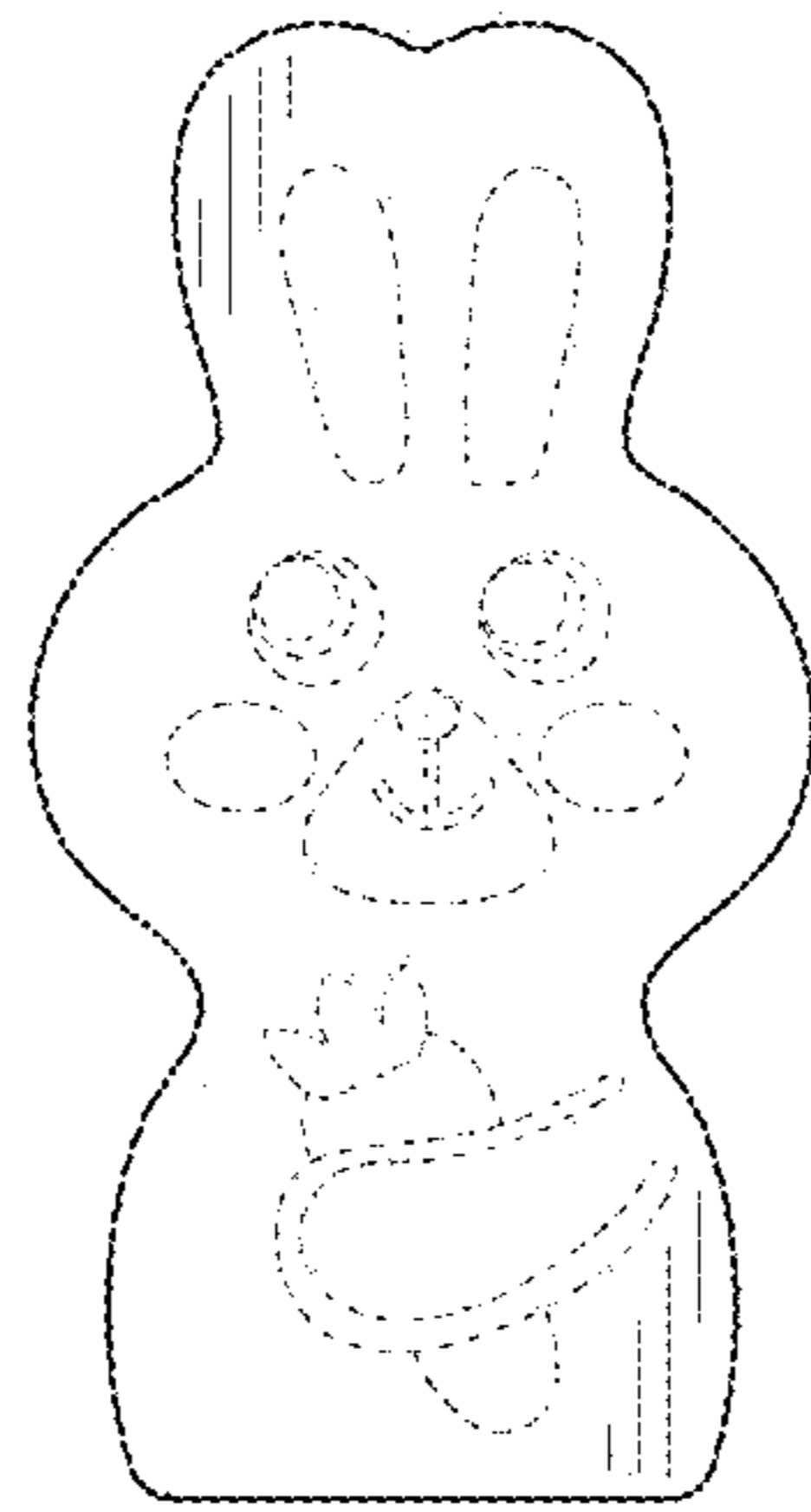

FIG. 11

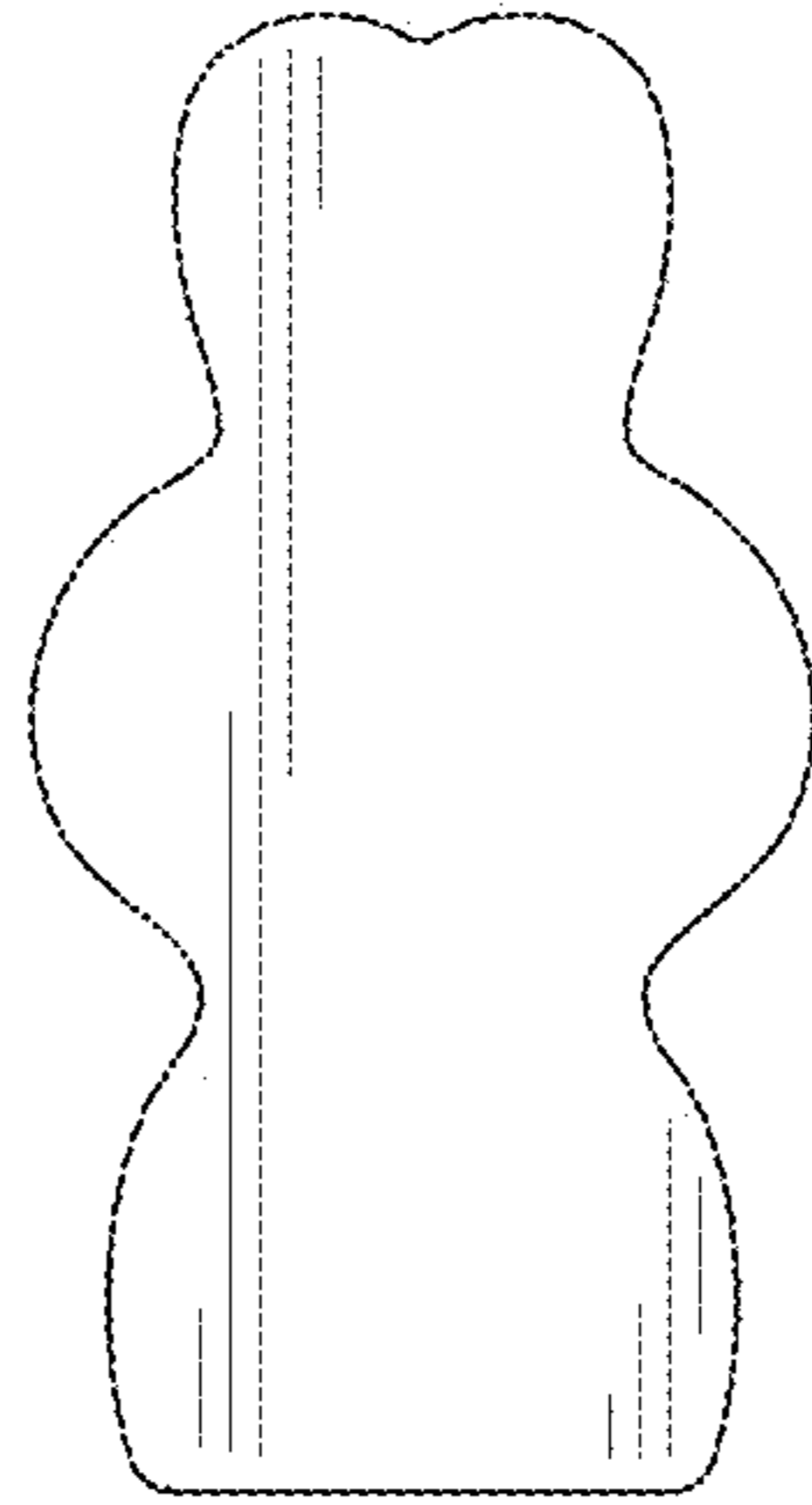

FIG. 12

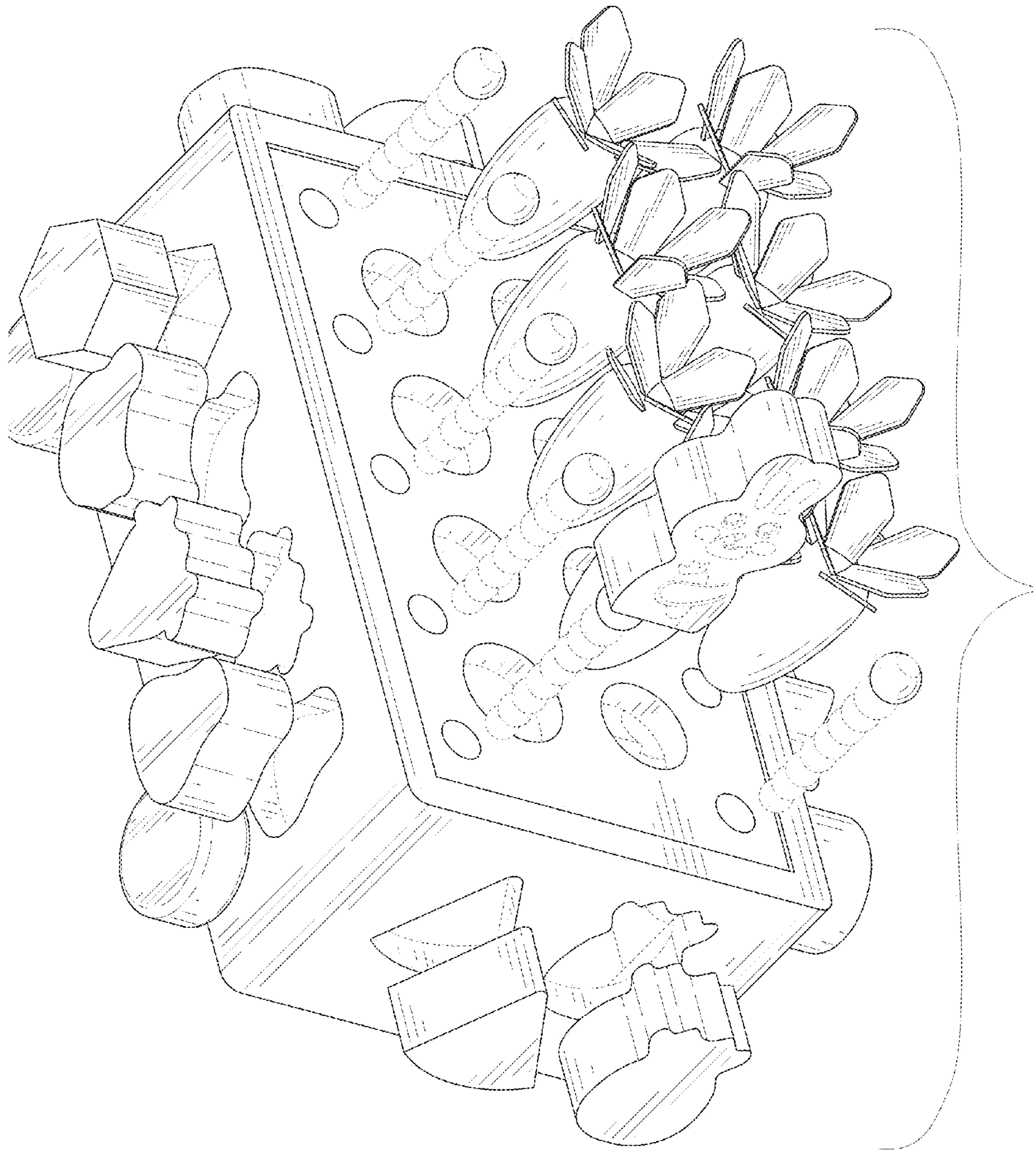

FIG. 13