

US00D971910S

(12) **United States Design Patent** (10) **Patent No.:** **US D971,910 S**
Chen (45) **Date of Patent:** **** Dec. 6, 2022**

(54) **PHONE CASE**

- (71) Applicant: **Huijin Chen**, Dongguan (CN)
- (72) Inventor: **Huijin Chen**, Dongguan (CN)
- (73) Assignee: **Huijin Chen**, Dongguan (CN)
- (**) Term: **15 Years**

(21) Appl. No.: **29/848,339**

(22) Filed: **Aug. 2, 2022**

(51) **LOC (13) Cl.** **14-03**

(52) **U.S. Cl.**
USPC **D14/250**

(58) **Field of Classification Search**

USPC D14/250, 203.3–203.7, 439, 251–253,
D14/447, 217, 240, 238.1, 440, 248;
D3/247, 249, 269, 273, 301, 303
CPC ... H04B 1/3888; A45C 1/06; A45C 2011/002;
A45F 2005/028; A45F 2200/0525
See application file for complete search history.

(56) **References Cited**

U.S. PATENT DOCUMENTS

- 2,815,126 A * 12/1957 Deckers A61F 15/001
150/147
- D543,359 S * 5/2007 Suppangig D3/247
- D707,219 S * 6/2014 Kim D14/250
- D714,054 S * 9/2014 Kershenstein D3/269
- D733,111 S * 6/2015 Kim D14/250
- D751,539 S * 3/2016 Ahn D14/250
- D756,342 S * 5/2016 Lee D14/250
- D767,888 S * 10/2016 Kim D3/249
- D772,214 S * 11/2016 Daniel D14/250
- D803,558 S * 11/2017 Liu D3/247

(Continued)

FOREIGN PATENT DOCUMENTS

- CN 301967396 * 6/2012
- KR 300740444.0000 * 4/2014

OTHER PUBLICATIONS

Casebus, “Magnetic Folio Wallet Phone Case . . . ” available at casebus.com, oldest review date Jun. 5, 2021, site visited Oct. 19, 2022, Available at URL: <https://bit.ly/3VF4IKd> (Year: 2021).*

(Continued)

Primary Examiner — Daniel J Domino

Assistant Examiner — Samina Vieth

(74) *Attorney, Agent, or Firm* — Nitin Kaushik

(57) **CLAIM**

The ornamental design for a phone case, as shown and described.

DESCRIPTION

FIG. 1 is a front perspective view of a phone case, showing my new design;
 FIG. 2 is a front view thereof;
 FIG. 3 is a rear view thereof;
 FIG. 4 is a left side view thereof;
 FIG. 5 is a right side view thereof;
 FIG. 6 is a top view thereof;
 FIG. 7 is a bottom view thereof;
 FIG. 8 is a rear perspective view of its use state;
 FIG. 9 is a front perspective view of its use state;
 FIG. 10 is its folded state diagram;
 FIG. 11 is a front perspective view of another embodiment thereof;
 FIG. 12 is a front view thereof;
 FIG. 13 is a rear view thereof;
 FIG. 14 is a left side view thereof;
 FIG. 15 is a right side view thereof;
 FIG. 16 is a top view thereof;
 FIG. 17 is a bottom view thereof;
 FIG. 18 is its use state diagram; and,
 FIG. 19 is its folding state diagram.

The broken lines in the drawings illustrate the portions of the phone case, which form no part of the claimed design.

1 Claim, 19 Drawing Sheets

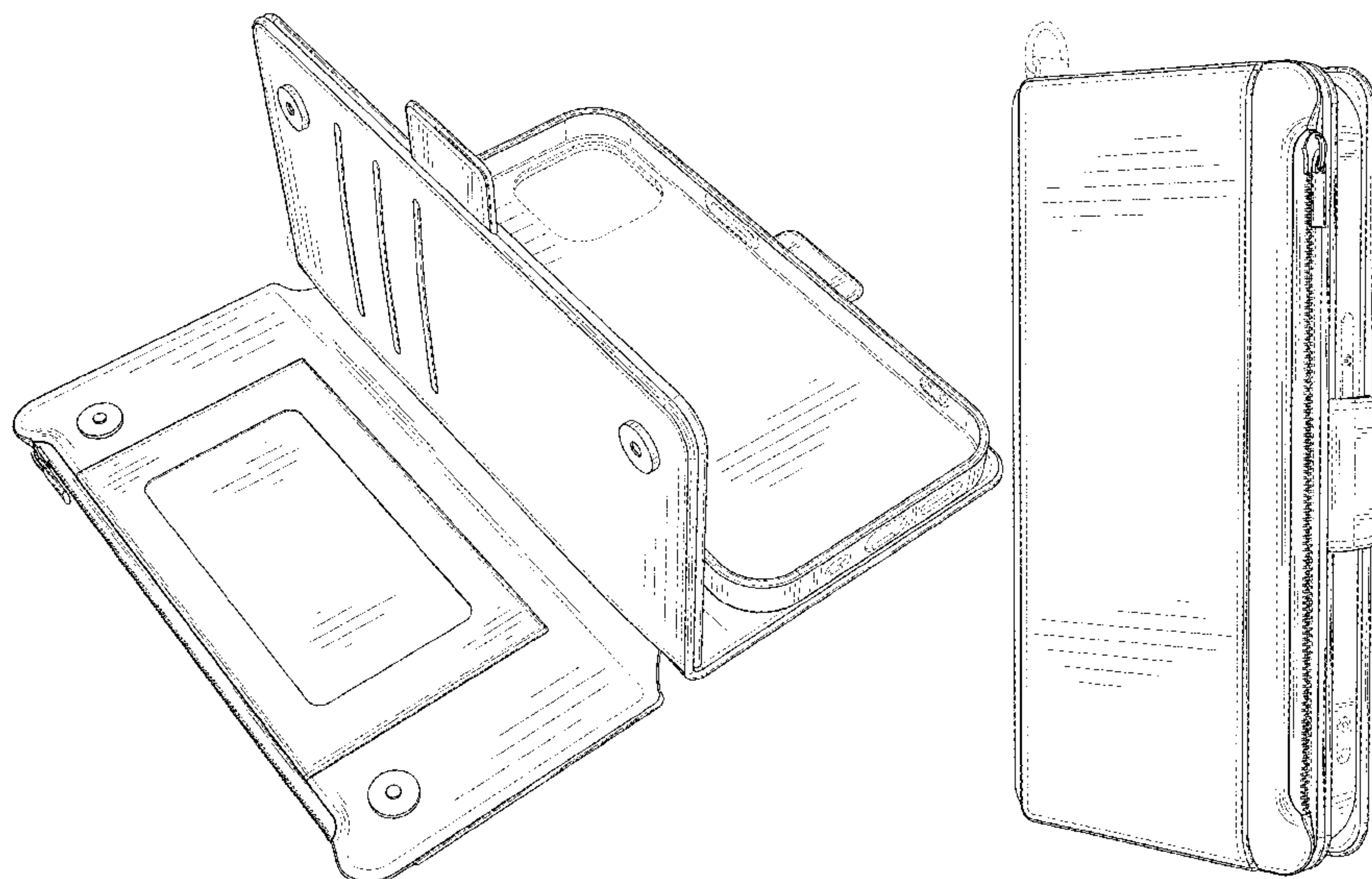

(56)

References Cited

OTHER PUBLICATIONS

U.S. PATENT DOCUMENTS

D814,185	S	*	4/2018	Liu	D3/249
D822,989	S	*	7/2018	Persson	D3/249
D843,992	S	*	3/2019	Lu	D14/250
D856,671	S	*	8/2019	Li	D3/249
D858,096	S	*	9/2019	Liu	D3/249
D858,984	S	*	9/2019	Zucco	D3/247
D869,843	S	*	12/2019	Zhou	D3/249
D875,725	S	*	2/2020	Hintermann	D14/250
D891,416	S	*	7/2020	Yu	D3/249
D892,107	S	*	8/2020	Zhao	D14/250
D895,599	S	*	9/2020	Zhao	D14/250
D900,800	S	*	11/2020	Sirju	D3/249
D903,315	S	*	12/2020	Liu	D3/249
D906,321	S	*	12/2020	Feng	D3/249
D908,353	S	*	1/2021	Peng	D3/249
D917,442	S	*	4/2021	Feng	D3/249
D918,887	S	*	5/2021	Feng	D3/249
D924,861	S	*	7/2021	Zhong	D14/250
D926,747	S	*	8/2021	Ryu	D14/250
D929,388	S	*	8/2021	Guo	D14/250
D956,033	S	*	6/2022	Hu	D14/250
D960,140	S	*	8/2022	He	D14/250
D965,578	S	*	10/2022	Liu	D14/249

Takfox, "Wallet Case for iPhone 11 . . ." available at amazon.com, date first available Sep. 6, 2019, site visited Oct. 19, 2022, Available at URL: <https://a.co/d/8b9bvBA> (Year: 2019).*

Defencase, "iPhone 14 Wallet Case . . ." available at amazon.com, date first available Sep. 15, 2022, site visited Oct. 19, 2022, Available at URL: <https://a.co/d/1yt15Dw> (Year: 2022).*

Antsturdy, "iPhone 14 16.1 Wallet Case" available at amazon.com, date first available Aug. 25, 2022, site visited Oct. 19, 2022, Available at URL: <https://a.co/d/fBpK3XG> (Year: 2022).*

MlnCYB, "Compatible with iPhone 14 Pro Wallet Case . . ." available at amazon.com, date first available Jul. 25, 2022, site visited Oct. 19, 2022, available at URL: <https://a.co/d/1idDiTV> (Year: 2022).*

Sailor Tech, "Magnetic Detachable 2 in 1 Wallet Phone Case . . ." available at amazon.com, date first available Oct. 12, 2021, site visited Oct. 19, 2022, available at URL: <https://www.amazon.com/Magnetic-Detachable-Google-Pixel-Kickstand/dp/B09J8NFG36?th=1> (Year: 2021).*

* cited by examiner

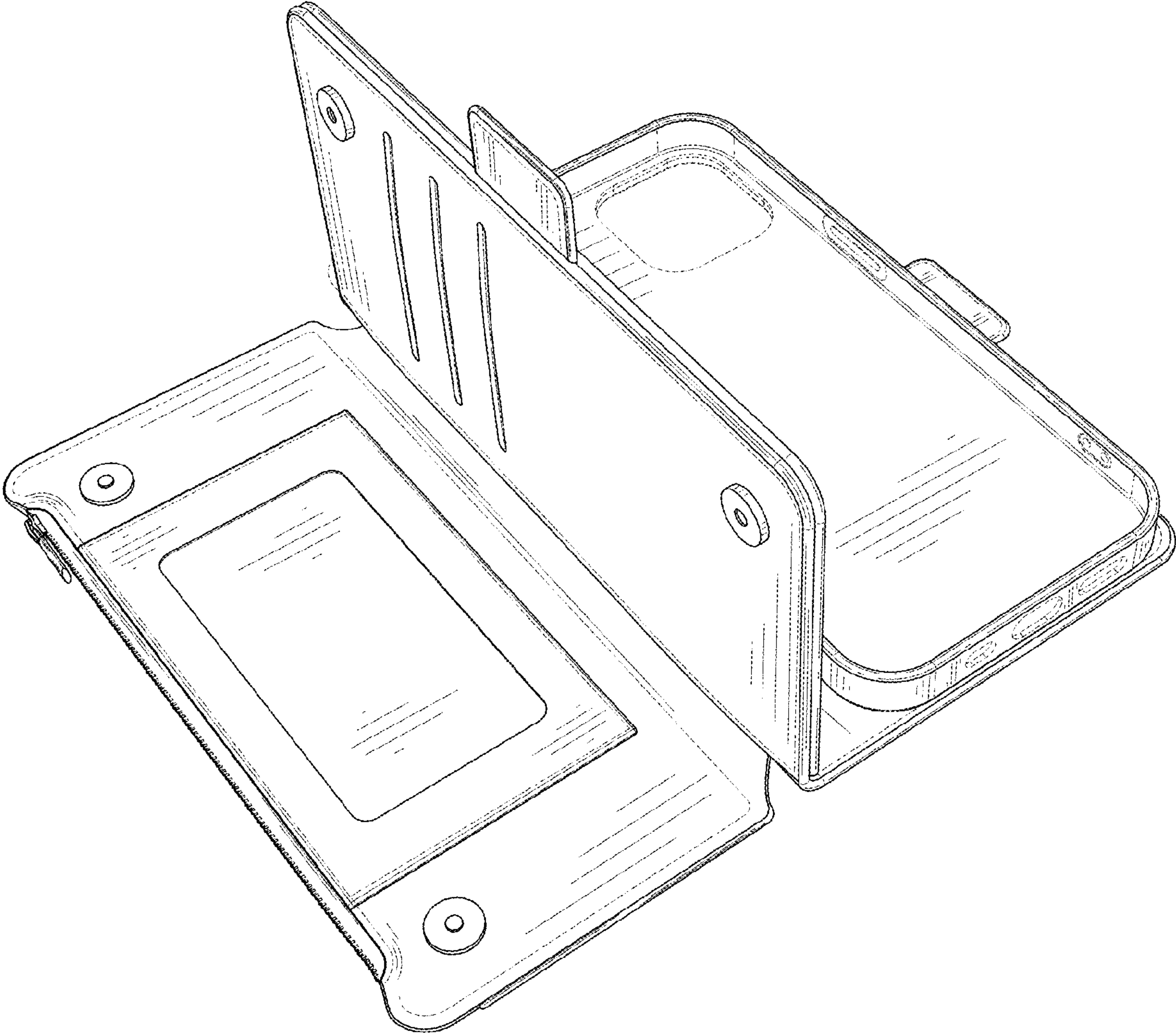

FIG.1

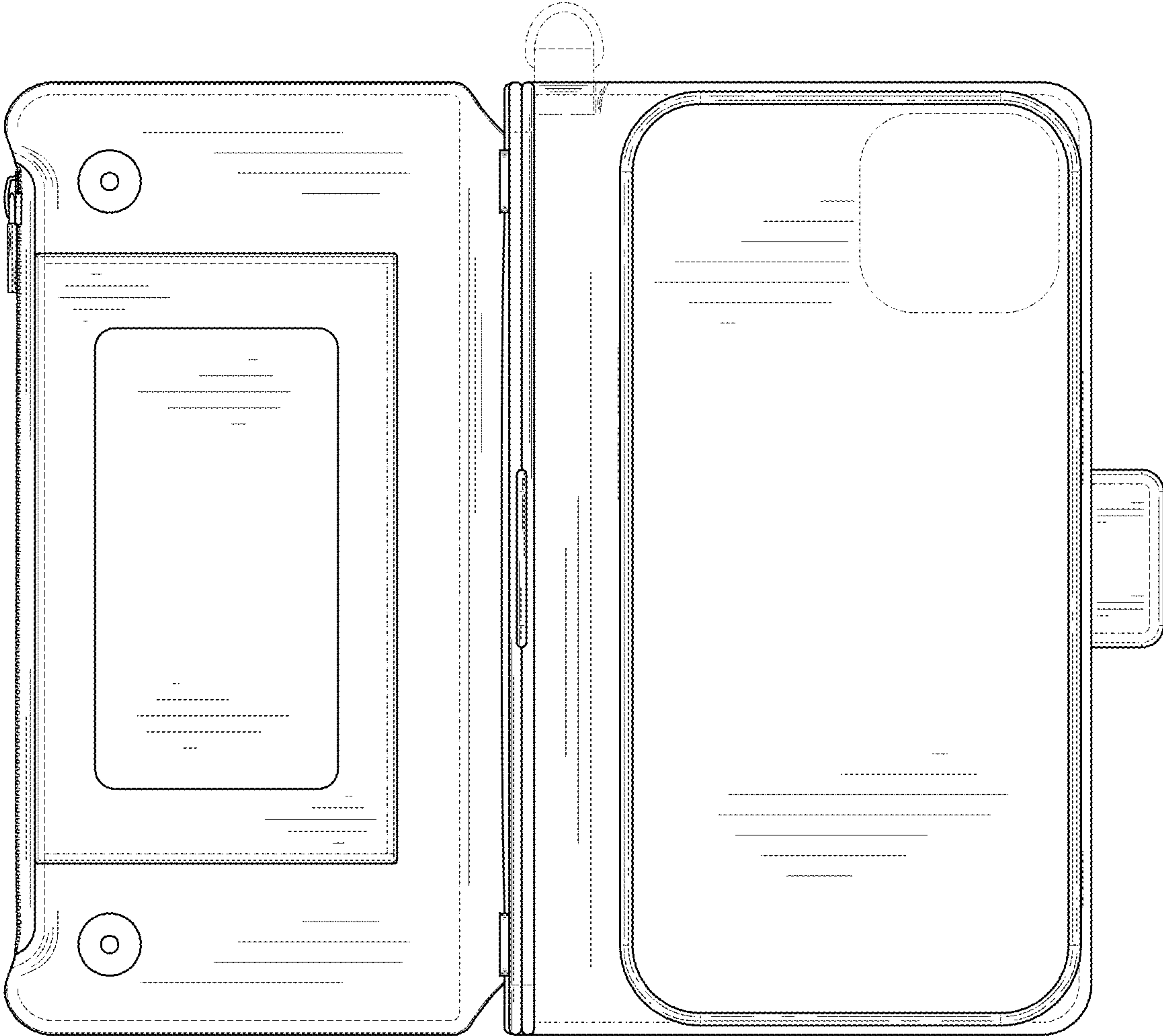

FIG.2

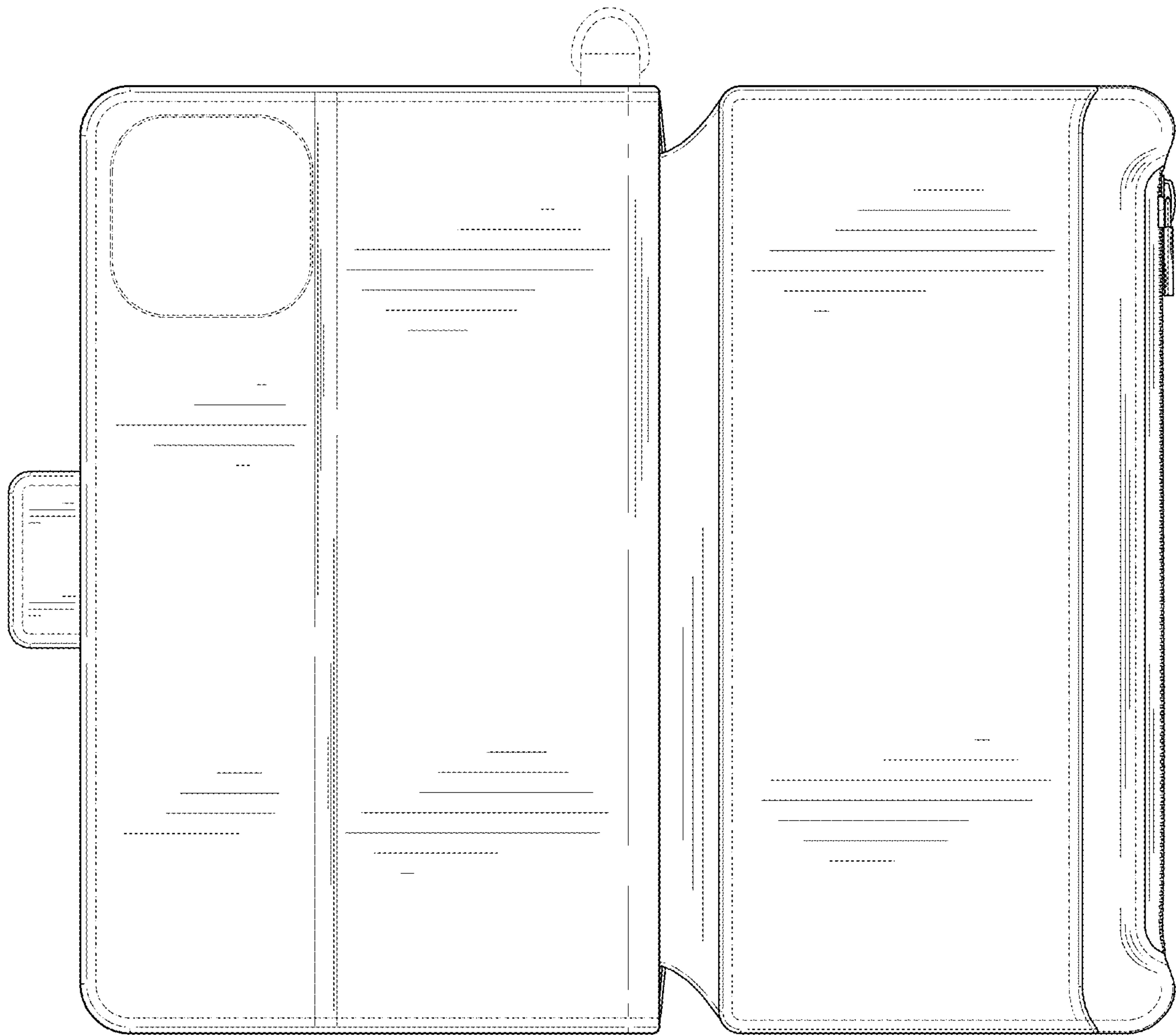

FIG.3

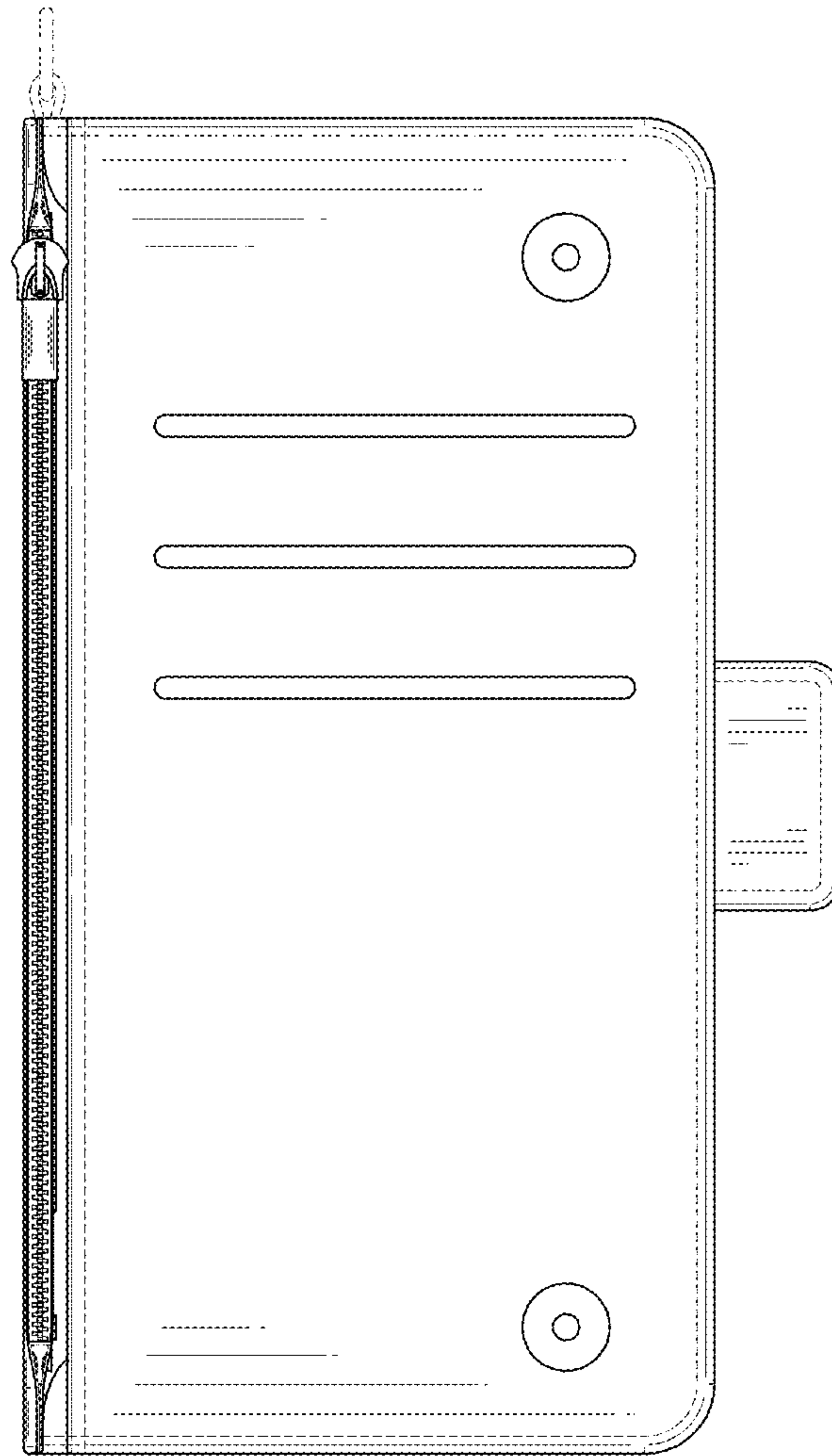

FIG.4

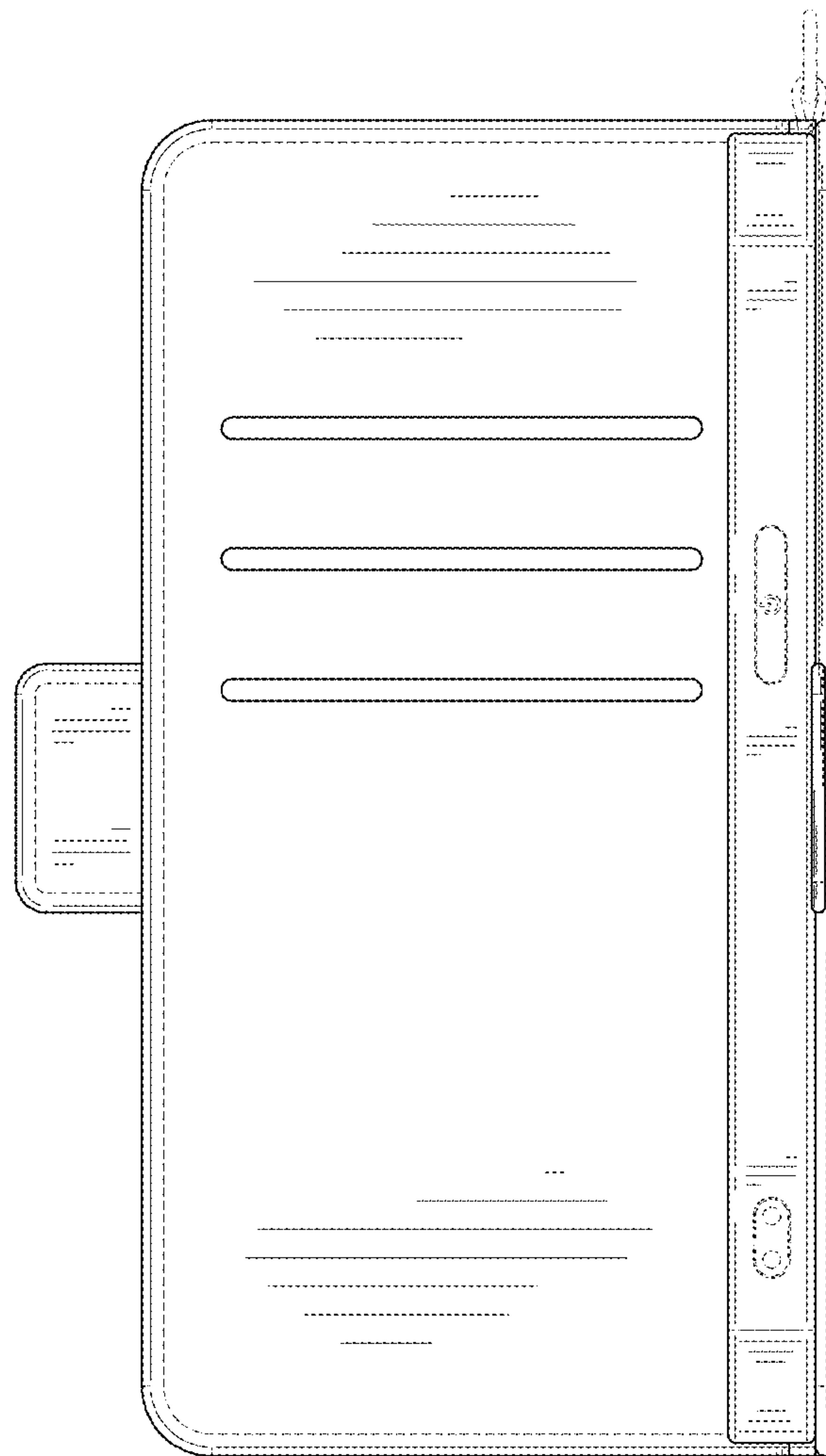

FIG. 5

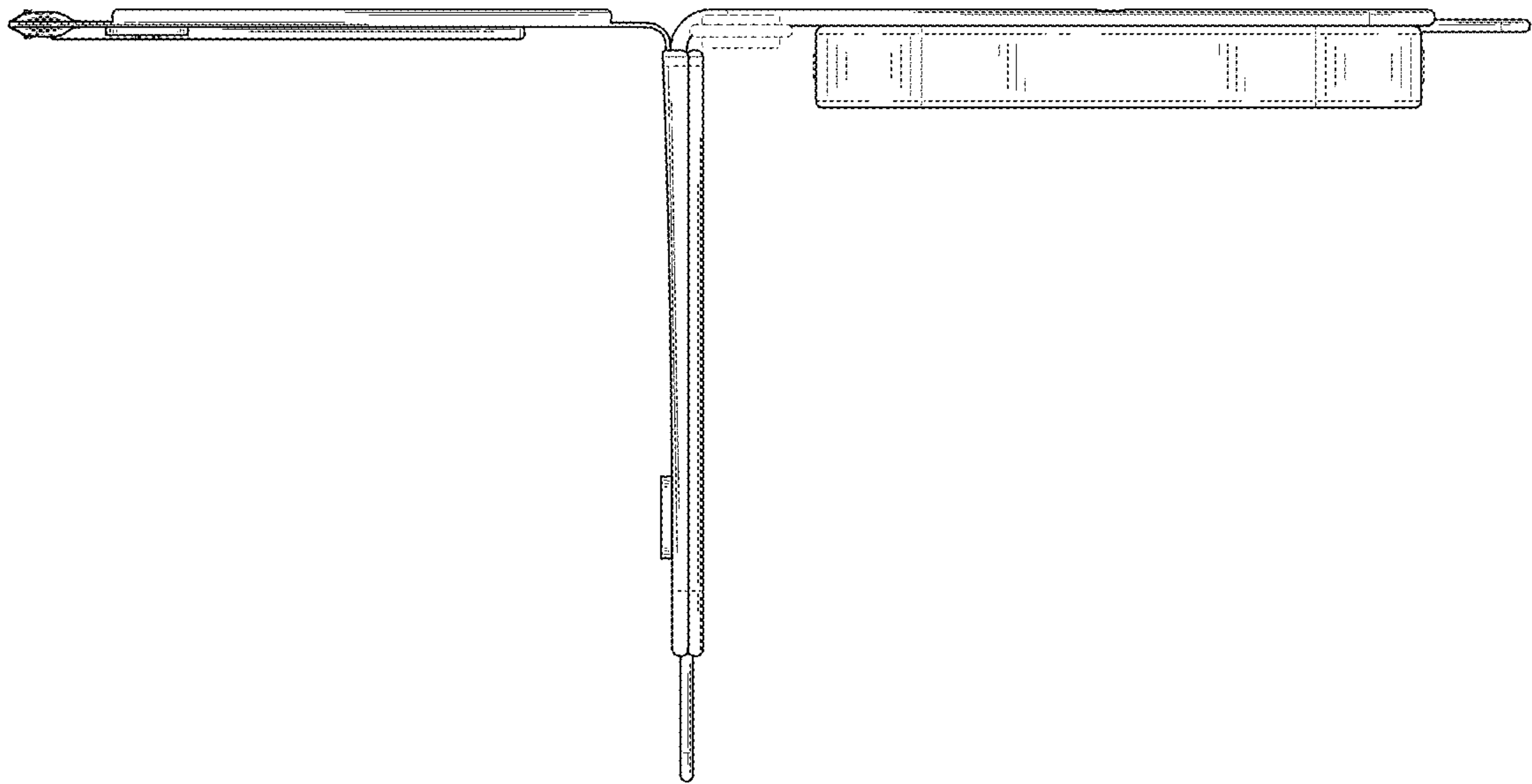

FIG.6

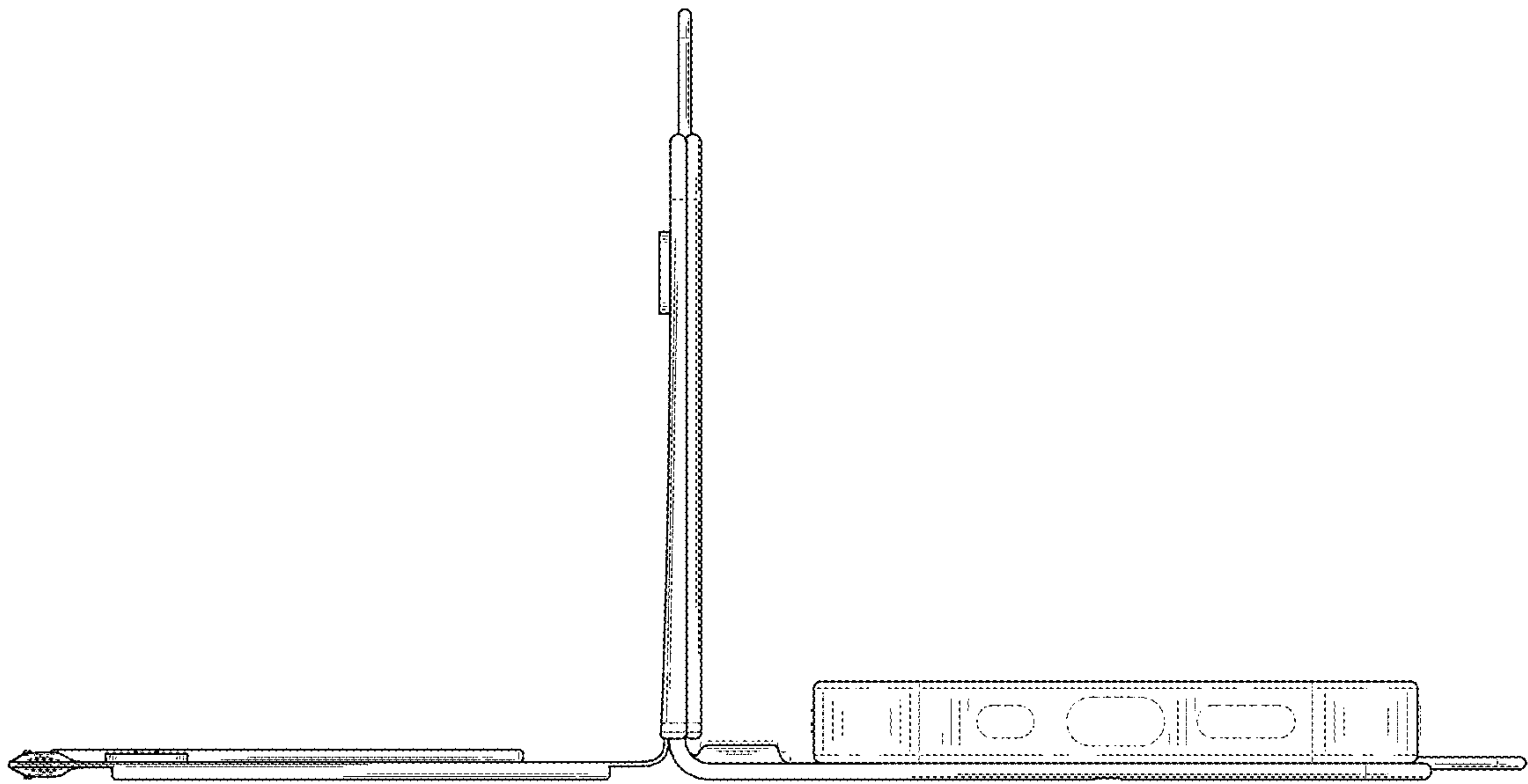

FIG. 7

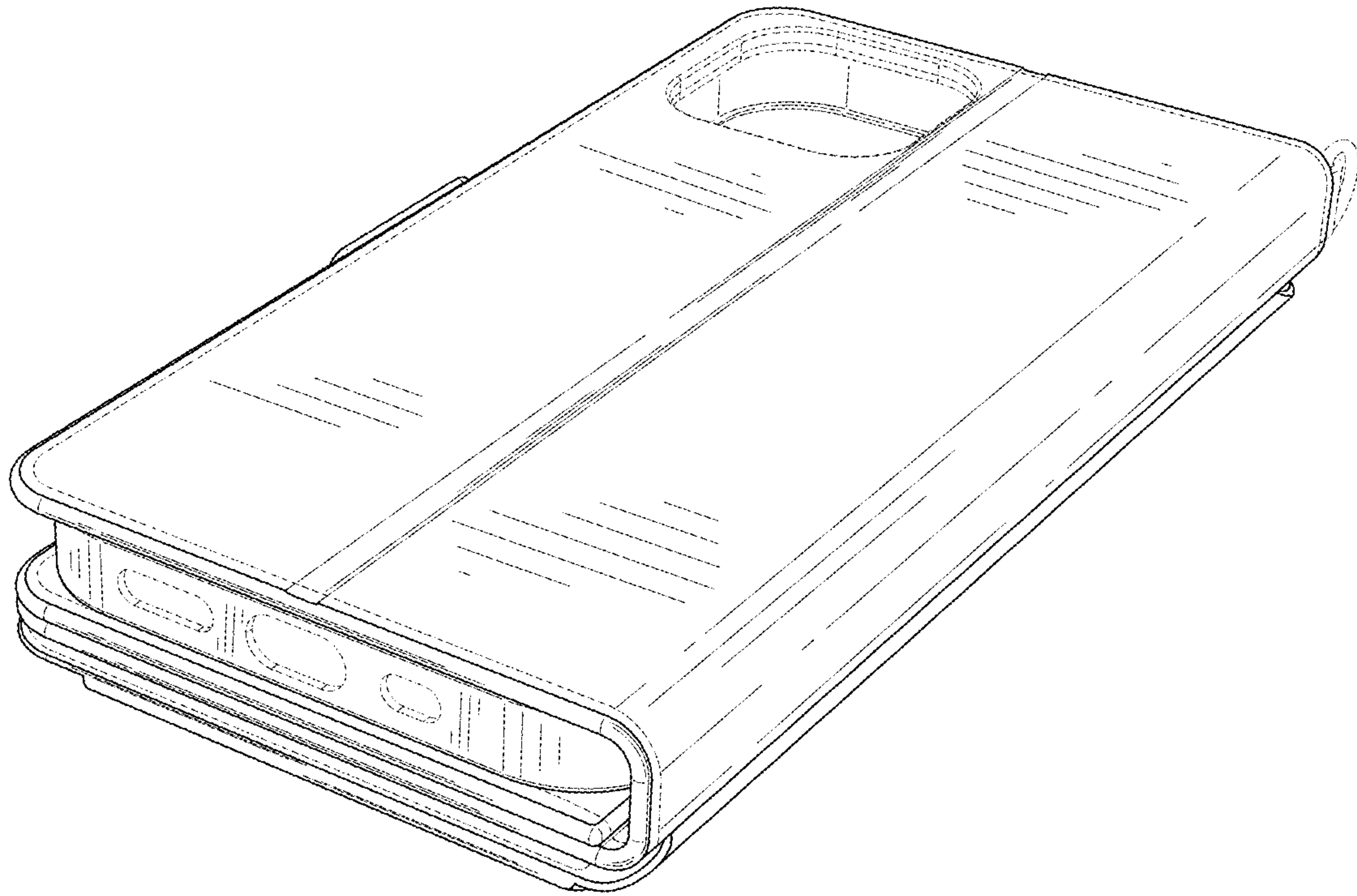

FIG. 8

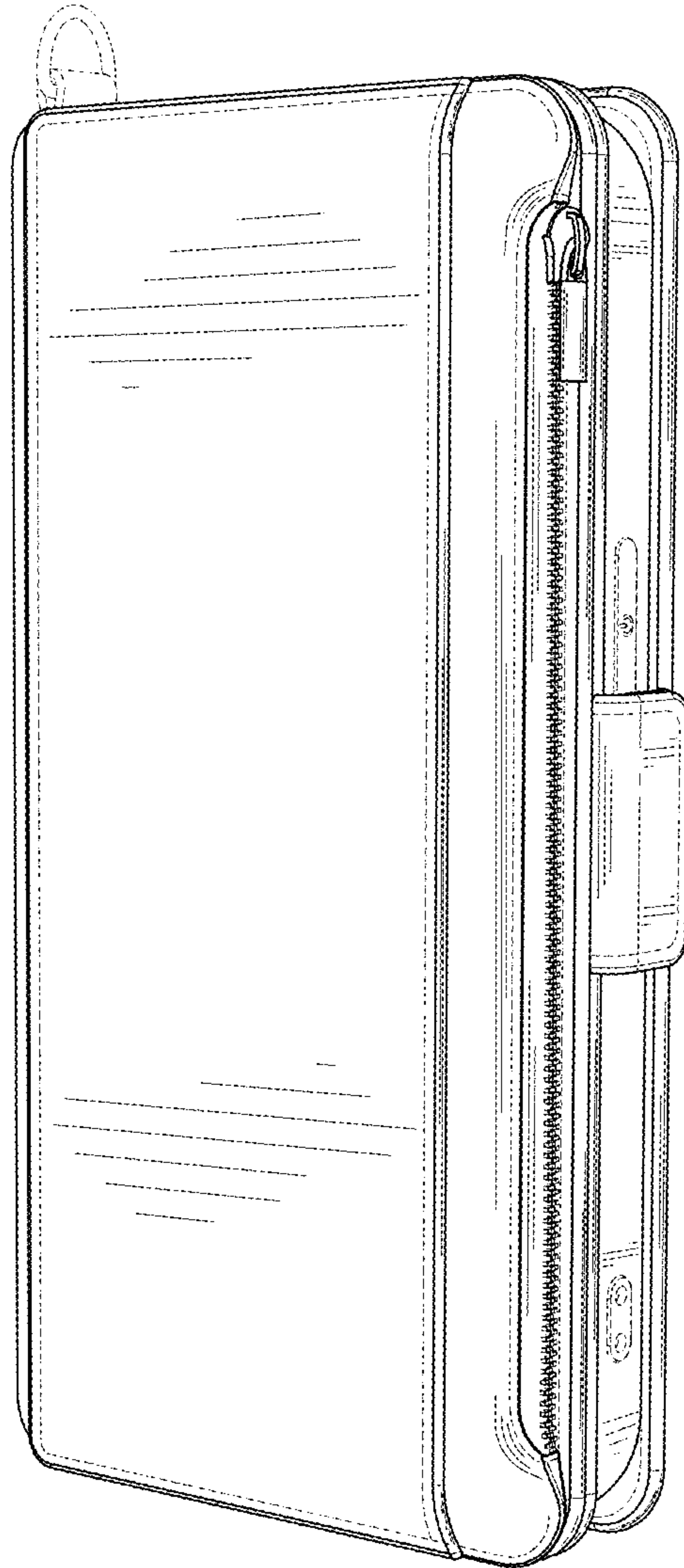

FIG.9

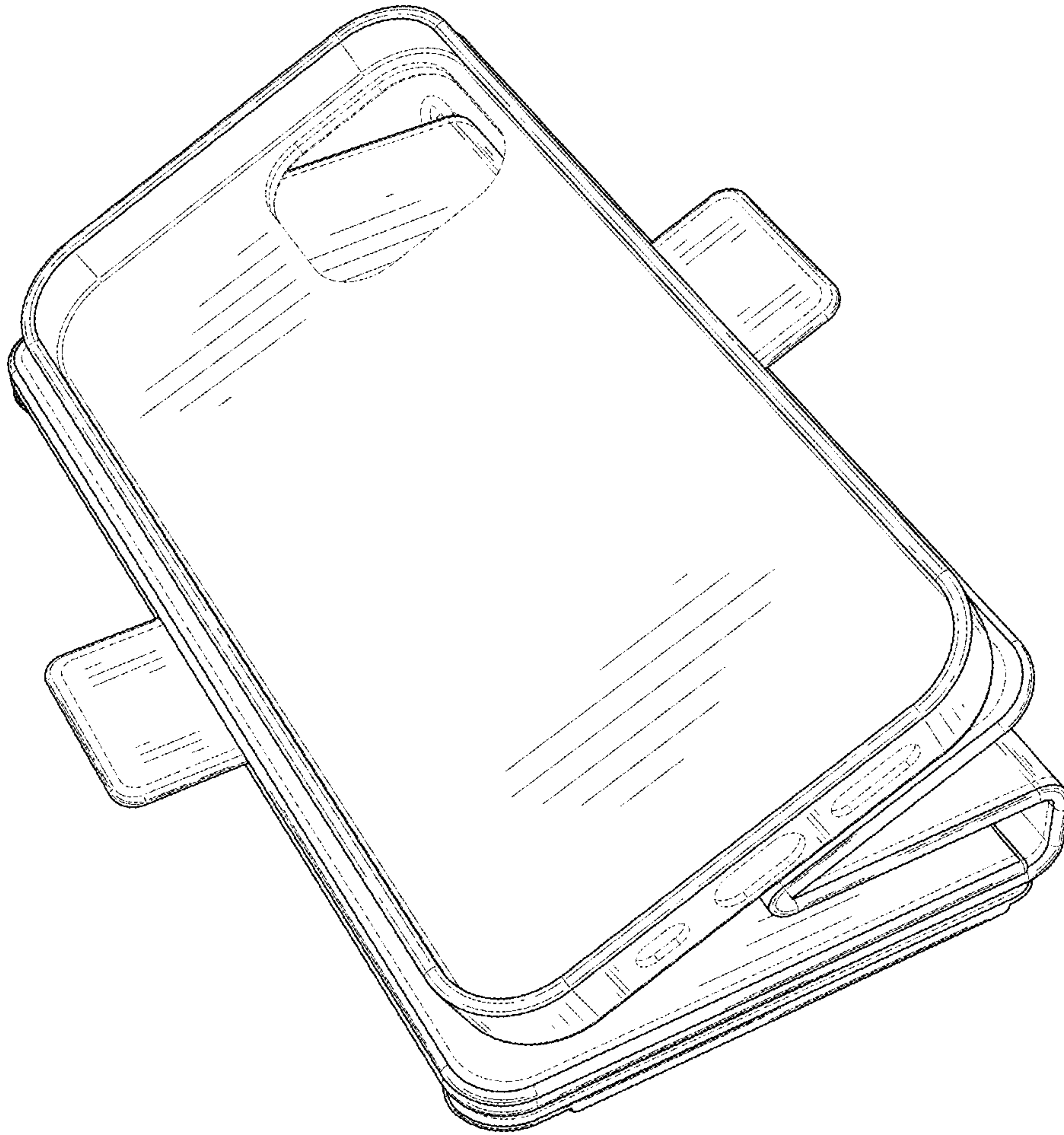

FIG.10

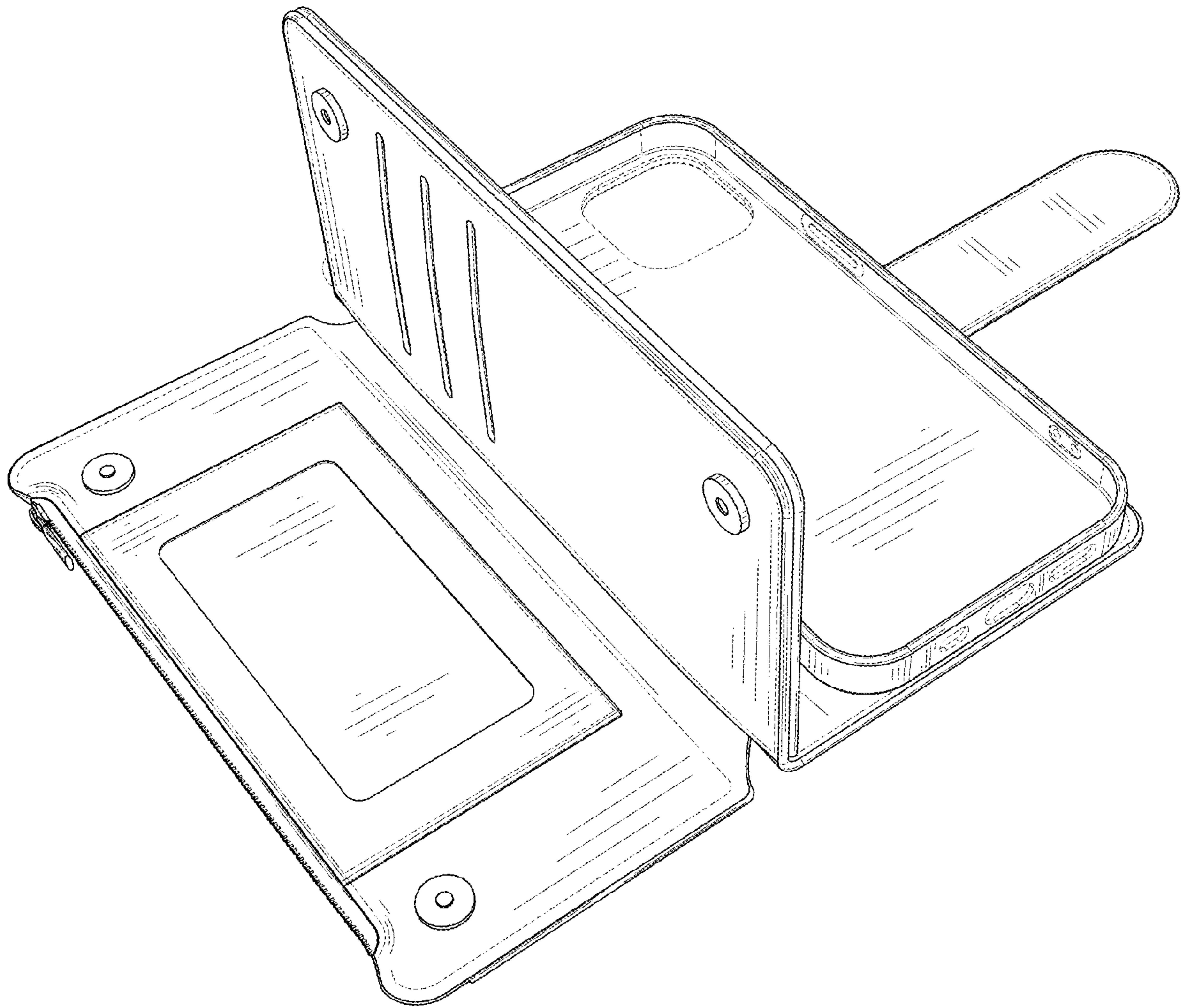

FIG.11

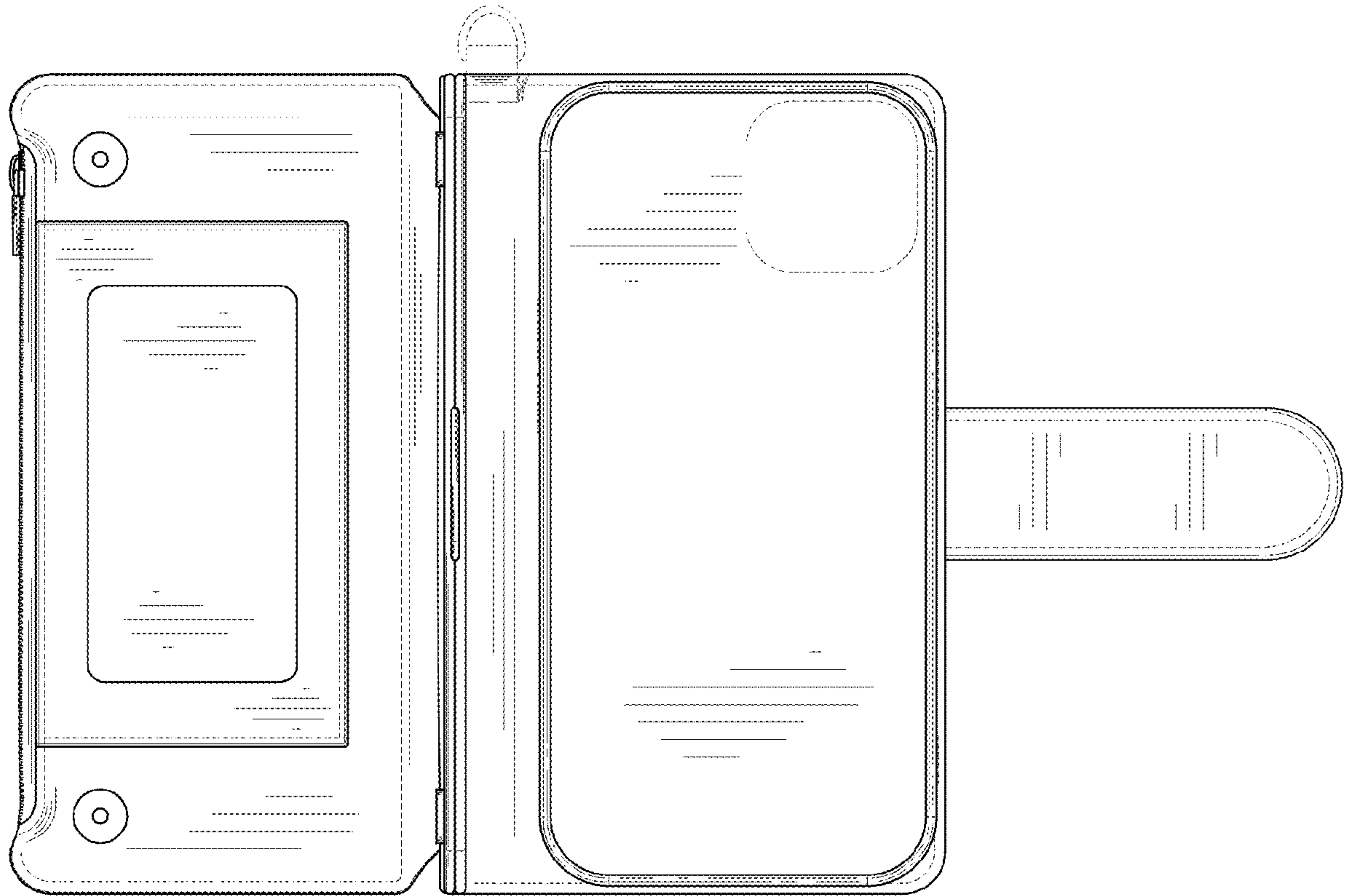

FIG.12

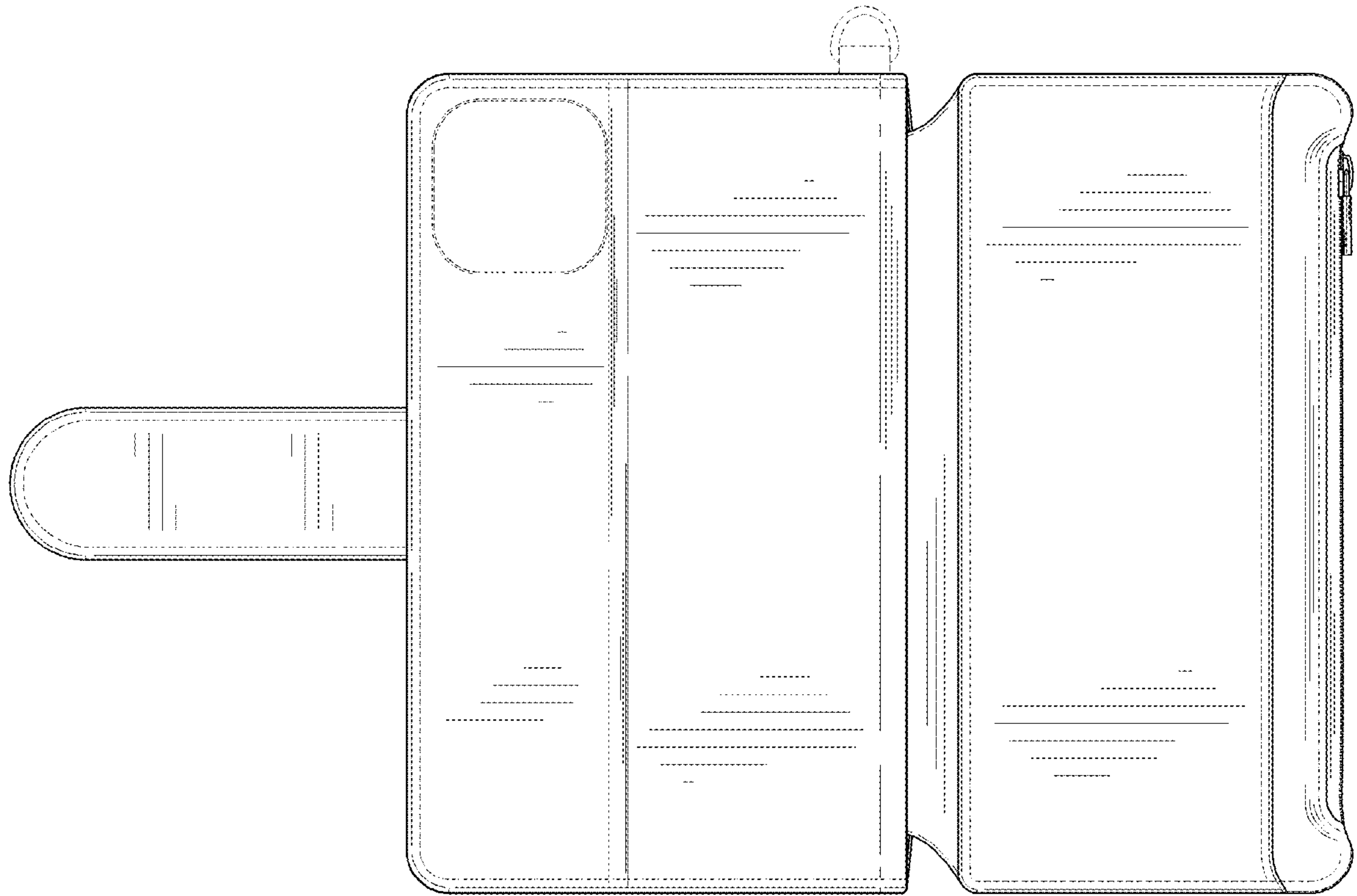

FIG.13

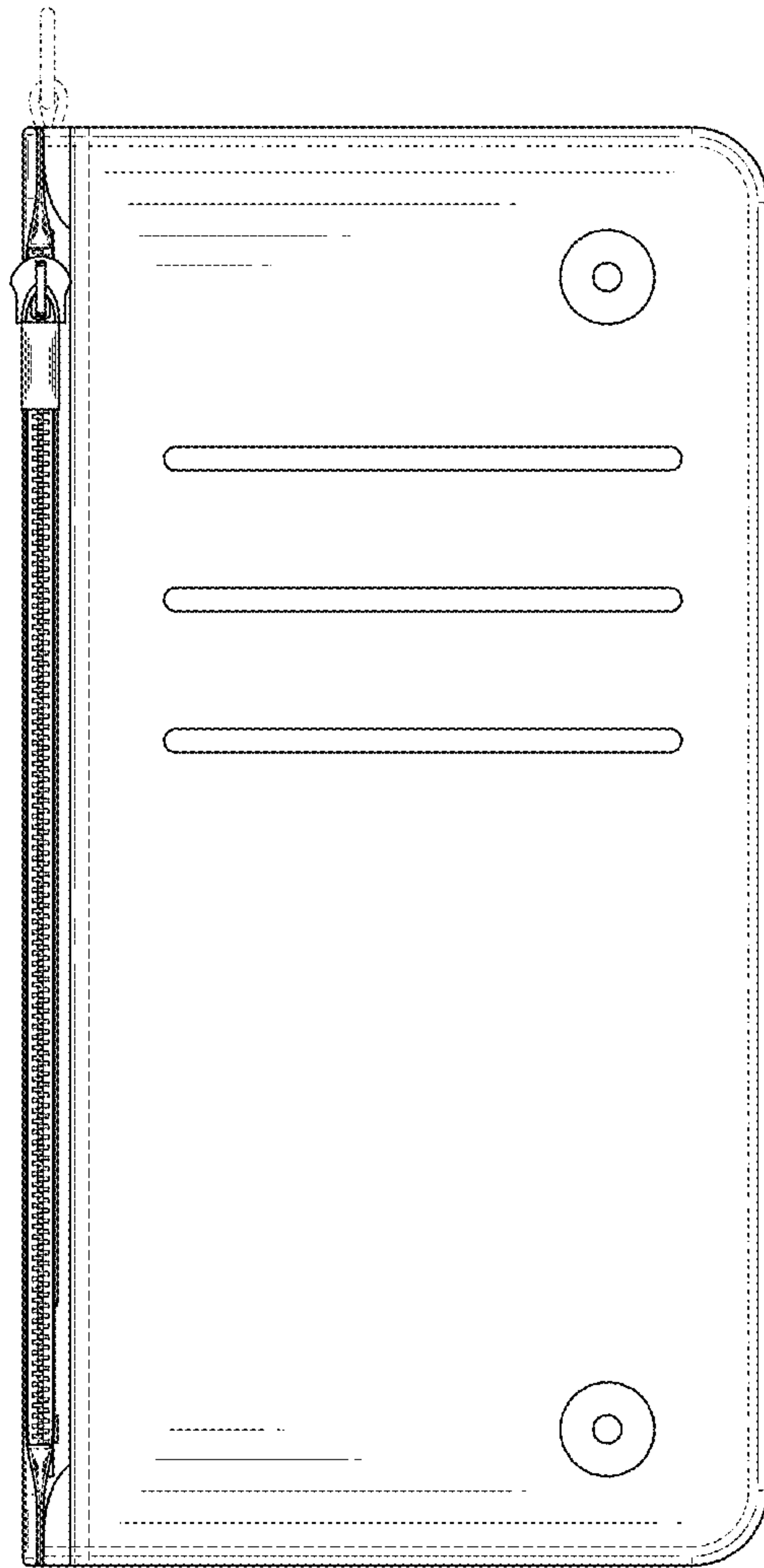

FIG.14

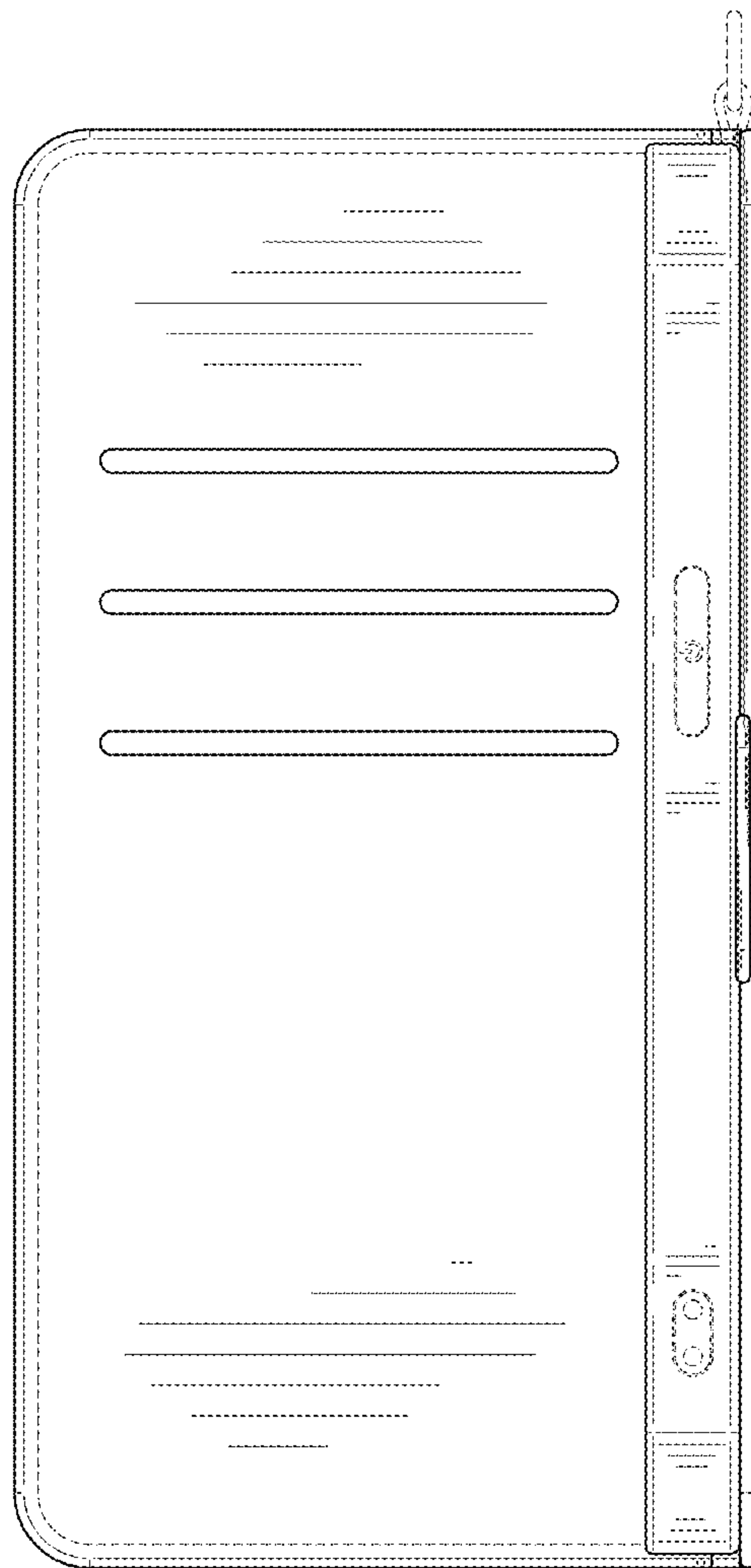

FIG.15

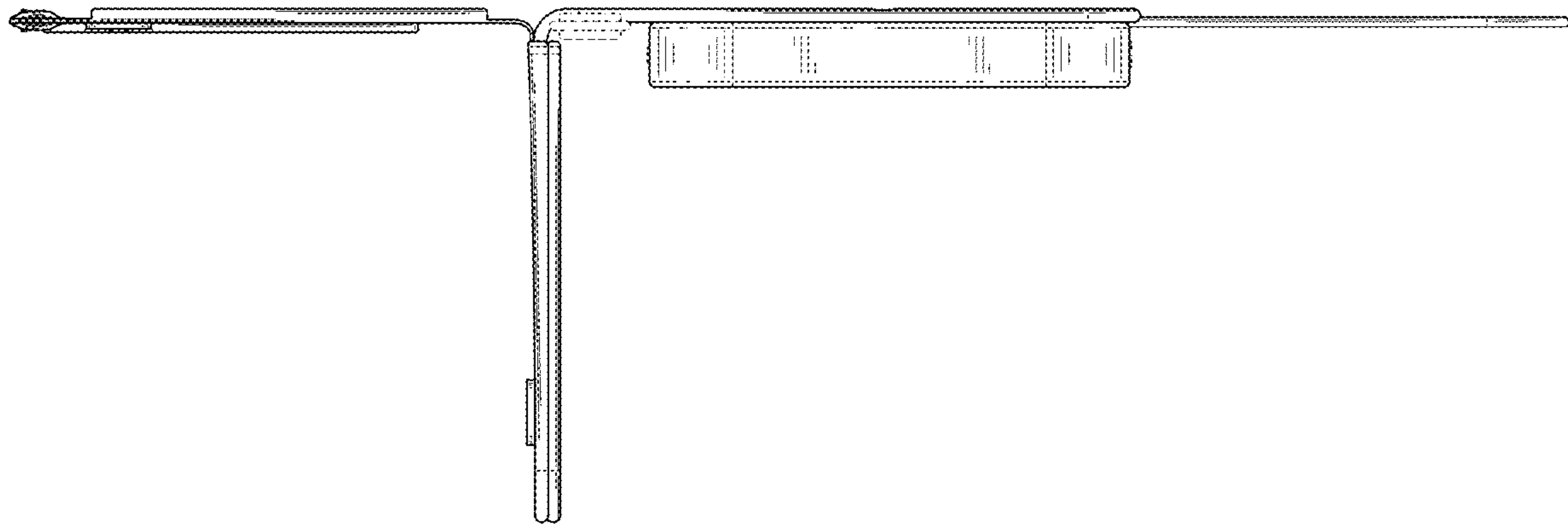

FIG.16

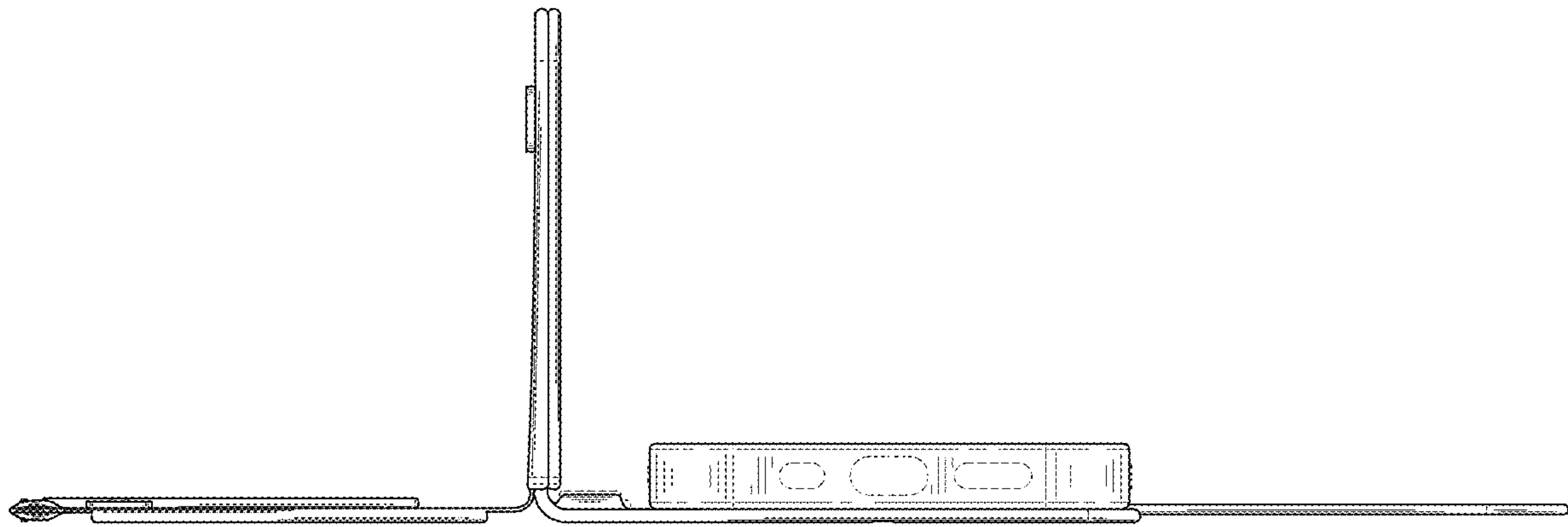

FIG.17

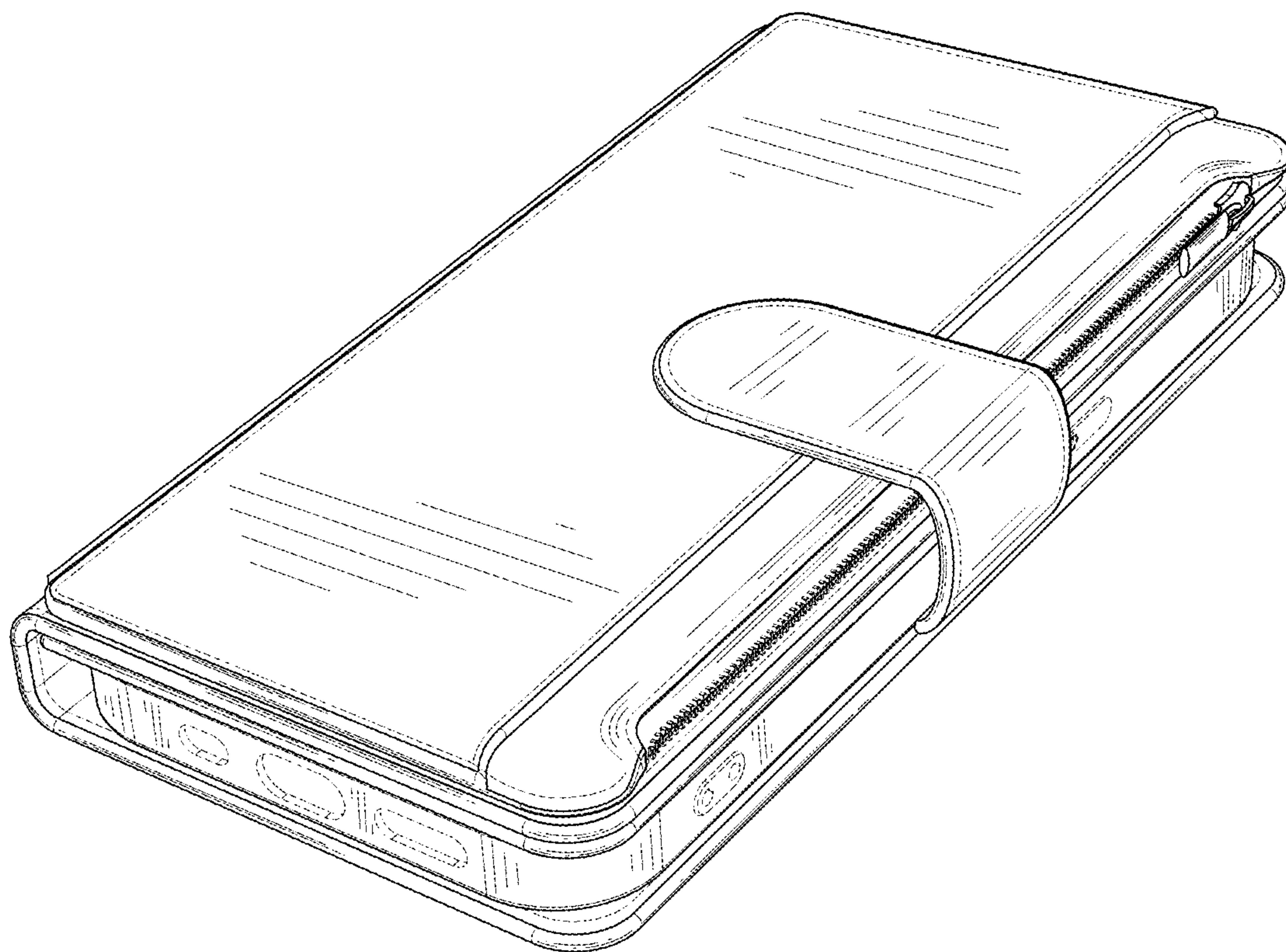

FIG.18

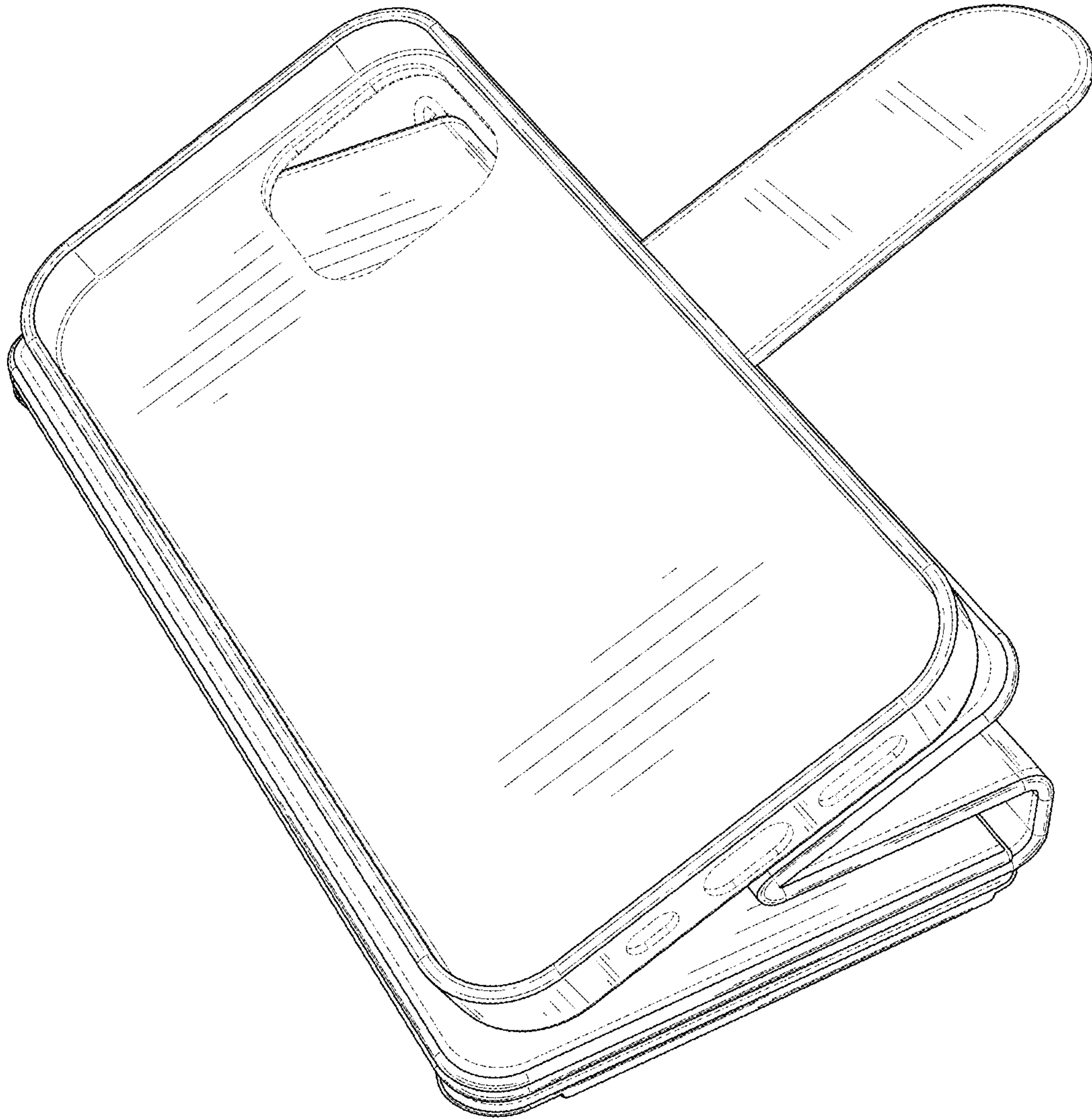

FIG.19