



US00D971906S

(12) **United States Design Patent**
Cho et al.

(10) **Patent No.:** **US D971,906 S**

(45) **Date of Patent:** **** Dec. 6, 2022**

(54) **CASE FOR ELECTRONIC DEVICE**

(71) Applicant: **Samsung Electronics Co., Ltd.**,
Suwon-si (KR)

(72) Inventors: **Yun-Su Cho**, Suwon-si (KR);
Hyun-Keun Son, Suwon-si (KR);
Bum-Soo Park, Suwon-si (KR);
Yoon-Young Kim, Suwon-si (KR)

(73) Assignee: **SAMSUNG ELECTRONICS CO., LTD.**,
Suwon-si (KR)

(**) Term: **15 Years**

(21) Appl. No.: **29/748,344**

(22) Filed: **Aug. 28, 2020**

(30) **Foreign Application Priority Data**

Apr. 10, 2020 (KR) 30-2020-0016063

(51) **LOC (13) Cl.** **14-03**

(52) **U.S. Cl.**
USPC **D14/250**

(58) **Field of Classification Search**
USPC D3/201, 218; D14/217, 248, 250–253,
D14/432, 434, 440, 441, 447
CPC H04B 1/3888; H04M 1/0283; H04M
1/0202; A45F 2005/028; A45F 2200/0525
See application file for complete search history.

(56) **References Cited**

U.S. PATENT DOCUMENTS

D757,704 S * 5/2016 Roberts D14/250
D761,781 S * 7/2016 Dang D14/250
D767,552 S * 9/2016 Sasaki D14/250
D784,976 S * 4/2017 Cebe D14/250

D834,572 S * 11/2018 Jung D14/250
D837,196 S * 1/2019 Kim D14/250
D837,779 S * 1/2019 Kim D14/250
D857,002 S * 8/2019 Kim D14/250
D857,684 S * 8/2019 Lee D14/250
D877,132 S * 3/2020 Yang D14/250
D880,469 S * 4/2020 Lee D14/250
D900,803 S * 11/2020 Ahn D14/250
D905,676 S * 12/2020 Kim D14/250
D908,680 S * 1/2021 Kim D14/250
D914,004 S * 3/2021 Lee D14/250
D917,448 S * 4/2021 Song D14/250
D917,450 S * 4/2021 Kim D14/250
D928,766 S * 8/2021 Park D14/250
D928,767 S * 8/2021 Kim D14/250

* cited by examiner

Primary Examiner — L. A. Grabenstetter

(74) *Attorney, Agent, or Firm* — McAndrews Held & Malloy, Ltd.

(57) **CLAIM**

The ornamental design for a case for electronic device, as shown and described.

DESCRIPTION

FIG. 1 is a front perspective view of a case for electronic device showing our new design;
FIG. 2 is a front elevation view thereof;
FIG. 3 is a rear elevation view thereof;
FIG. 4 is a left side elevation view thereof;
FIG. 5 is a right side elevation view thereof;
FIG. 6 is a top plan view thereof;
FIG. 7 is a bottom plan view thereof; and,
FIG. 8 is a rear perspective view thereof.

The broken lines in the figures illustrate portions of the case for electronic device that form no part of the claimed design.

1 Claim, 8 Drawing Sheets

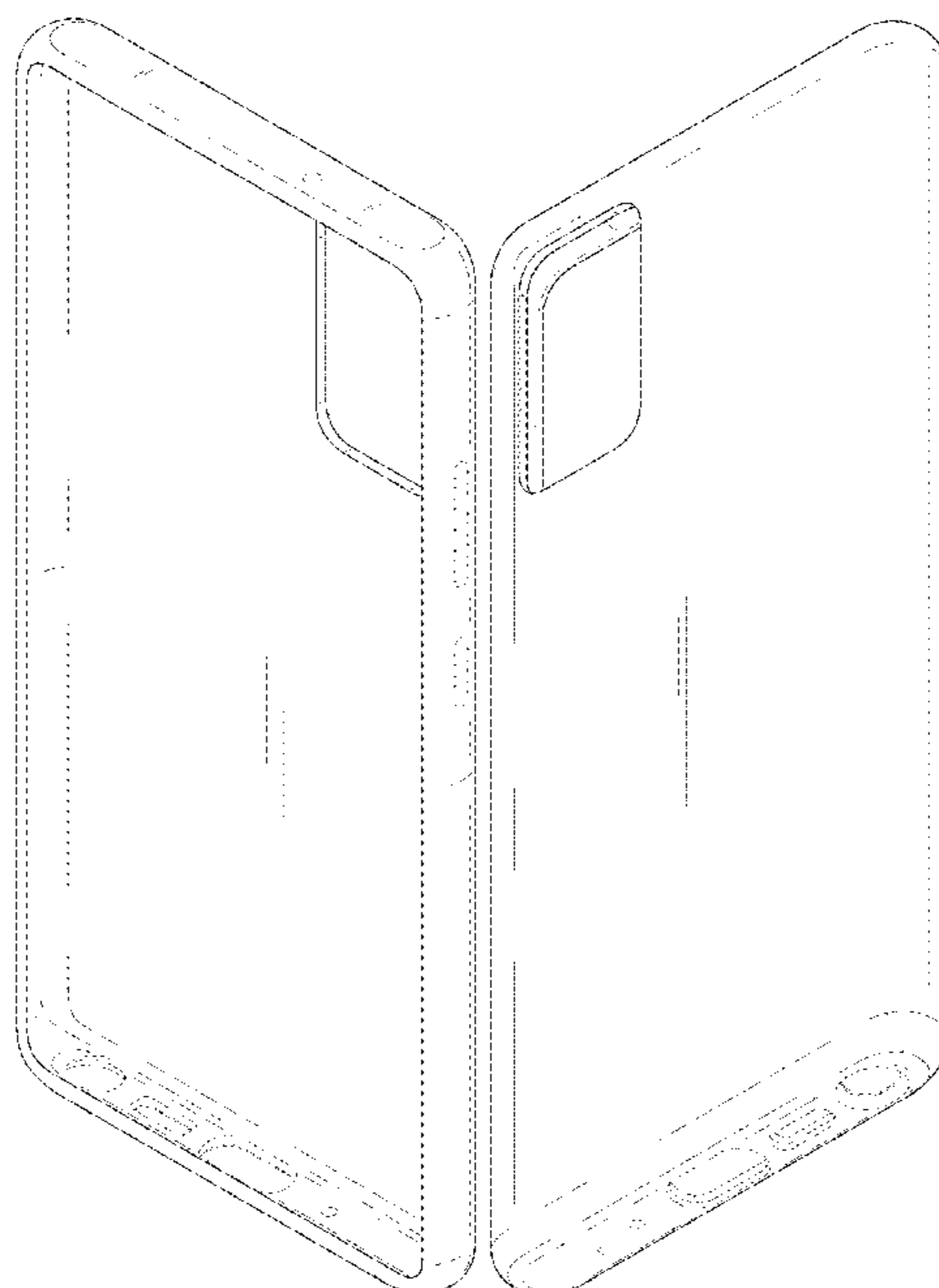

FIG. 1

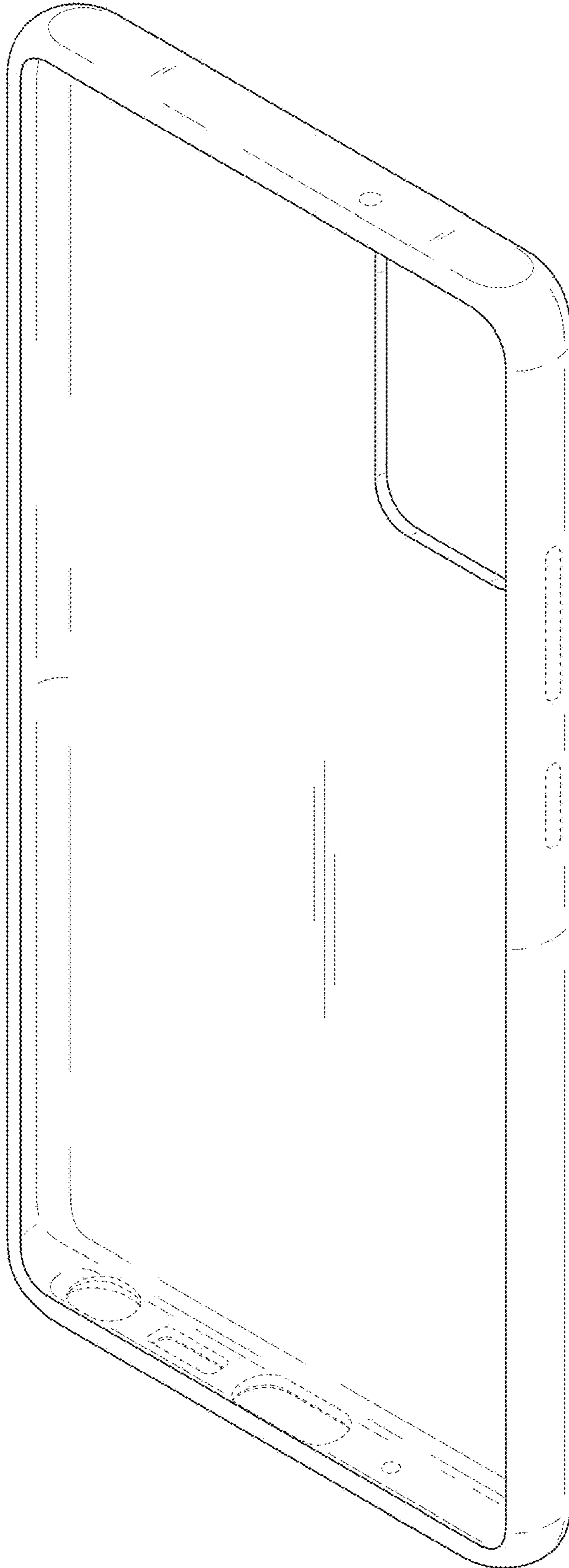

FIG. 2

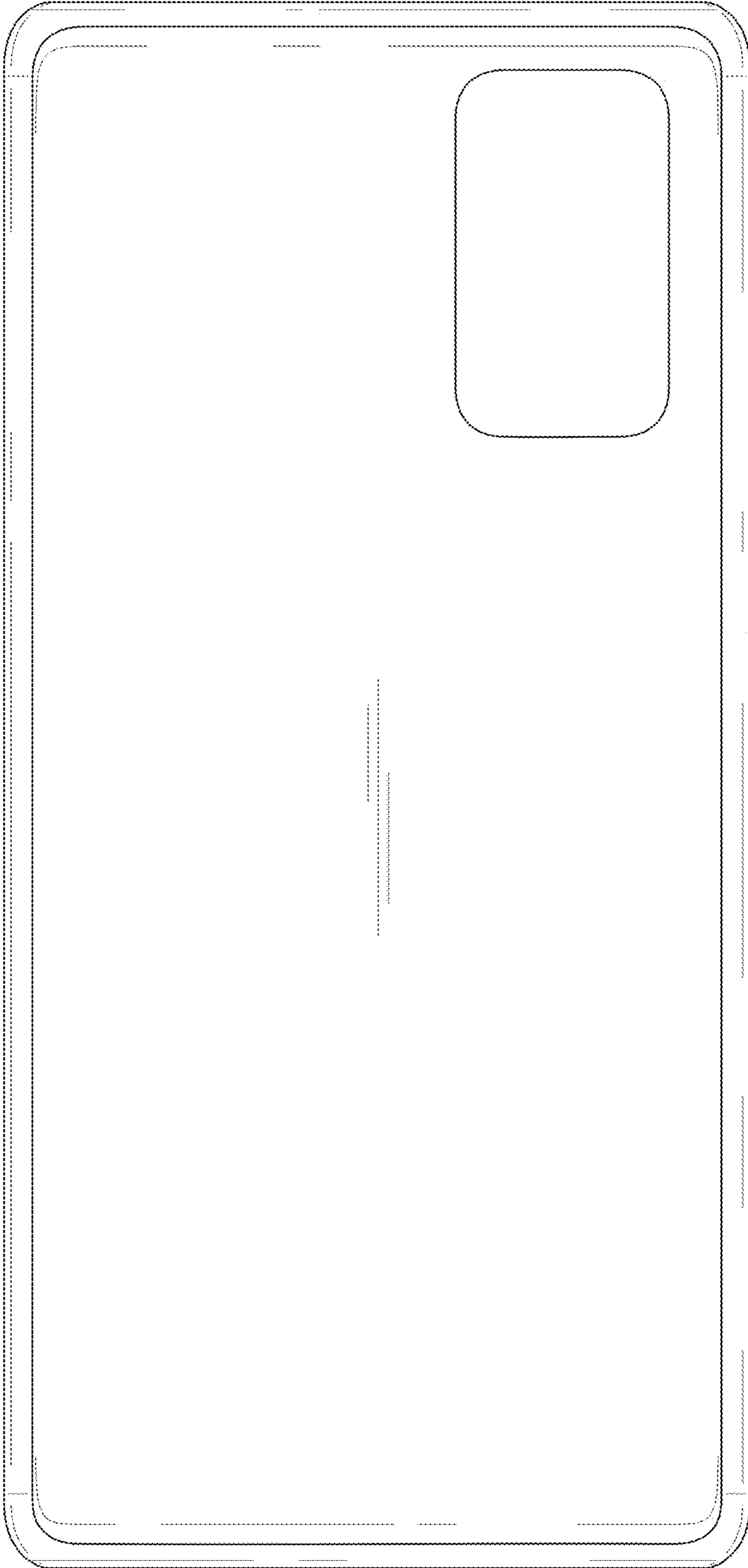

FIG. 3

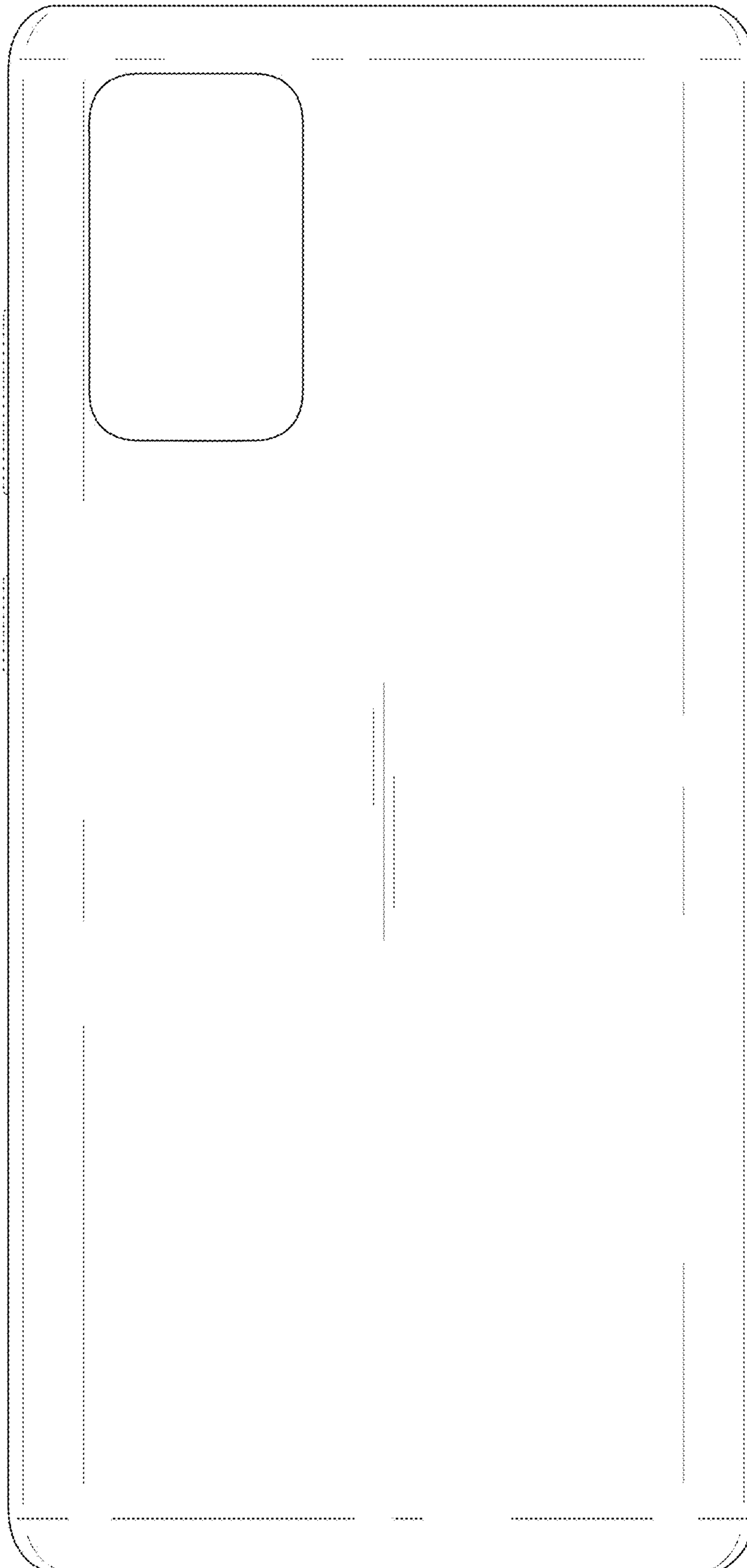

FIG. 4

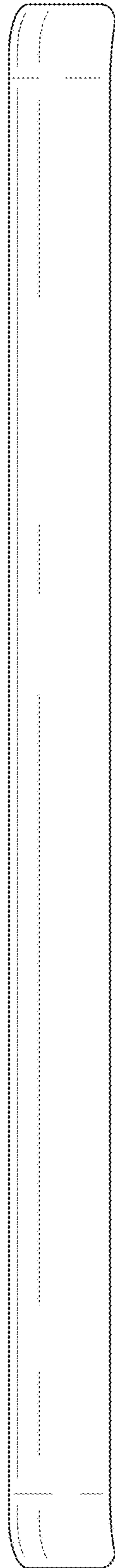

FIG. 5

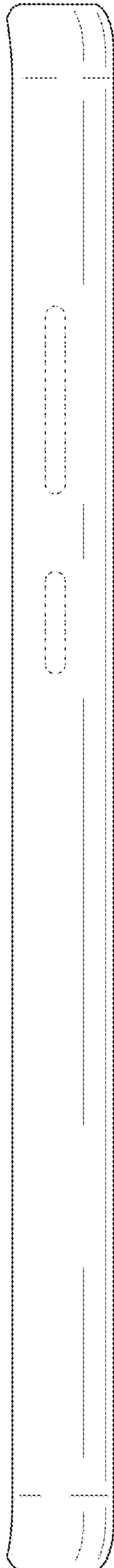

FIG. 6

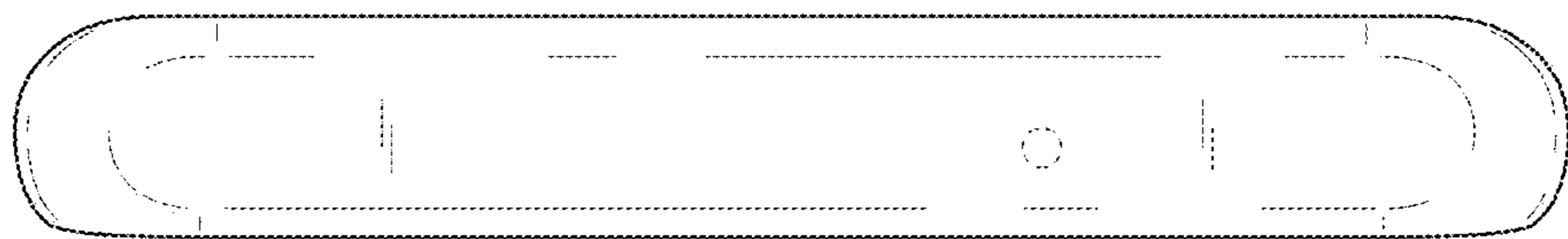

FIG. 7

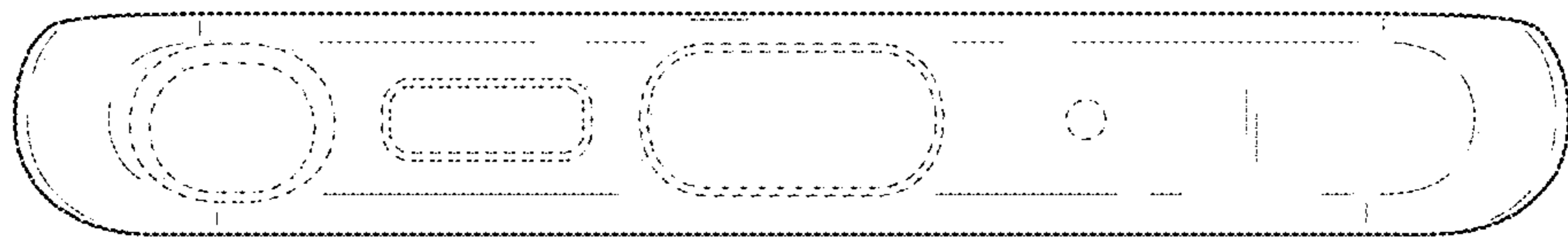

FIG. 8

