



US00D971848S

(12) **United States Design Patent** (10) **Patent No.:** **US D971,848 S**
Fu et al. (45) **Date of Patent:** **** Dec. 6, 2022**

(54) **SOCKET**

(71) Applicant: **SCHNEIDER ELECTRIC (AUSTRALIA) PTY LTD**, Macquarie Park (AU)

(72) Inventors: **Jiayu Fu**, Shenzhen (CN); **Fuhua Shan**, Shenzhen (CN); **Pei Shang**, Shenzhen (CN)

(73) Assignee: **Schneider Electric (Australia) PTY LTD**, Macquarie Park (AU)

(**) Term: **15 Years**

(21) Appl. No.: **29/806,132**

(22) Filed: **Sep. 1, 2021**

Related U.S. Application Data

(62) Division of application No. 29/703,917, filed on Aug. 30, 2019.

(51) **LOC (13) Cl.** **13-03**

(52) **U.S. Cl.**
USPC **D13/139.1**

(58) **Field of Classification Search**
USPC D13/137.1–137.4, 138.1, 138.2, D13/139.1–139.8, 171, 173, 174, 178, D13/184, 110

CPC .. H01R 13/639; H01R 13/6392; H01R 13/64; H01R 13/642; H01R 13/648; H01R 13/652; H01R 13/66; H01R 13/6666; H01R 13/6683; H01R 13/68; H01R 13/713; H01R 25/00; H01R 25/003; H01R 25/006; H01R 2103/00; H01R 24/20; H01R 24/22; H01R 24/28; H01R 24/30; H02G 3/12; H02G 3/14; H01H 73/06; H01H 71/58; H01H 83/04; H01H 73/08

See application file for complete search history.

(56) **References Cited**

U.S. PATENT DOCUMENTS

D536,305 S * 2/2007 Fort D13/139.6
D710,804 S 8/2014 Duffy et al.
D727,853 S 4/2015 Clayton
D735,137 S 7/2015 Duffy et al.
D745,371 S * 12/2015 Trojanowski D8/350
D779,436 S 2/2017 Huynh

(Continued)

OTHER PUBLICATIONS

TOPGREENER Smart Wifi Outlet with Energy Monitoring. Amazon. Oldest review date: Oct. 8, 2018. Retrieval date; Mar. 24, 2022. Retrieved from internet: <https://www.amazon.com/dp/B07BX13MLF> (Year: 2018).*

(Continued)

Primary Examiner — Mary Shannon Malley

Assistant Examiner — Lee D. Starr

(74) *Attorney, Agent, or Firm* — Locke Lord LLP

(57) **CLAIM**

The ornamental design for a socket, as shown and described.

DESCRIPTION

FIG. 1 is a front view of the socket, showing my new design.

FIG. 2 is a back view thereof.

FIG. 3 is a top view thereof.

FIG. 4 is a bottom view thereof.

FIG. 5 is a left side elevational view thereof.

FIG. 6 is a right side elevational view thereof.

FIG. 7 is a front perspective view thereof; and,

FIG. 8 is a back perspective view thereof.

The masked areas adjacent to the dash-dot broken lines in the drawings depict portions of the socket that form no part of the claimed design. The dash-dot broken lines define the bounds of the claimed design and form no part thereof.

1 Claim, 4 Drawing Sheets

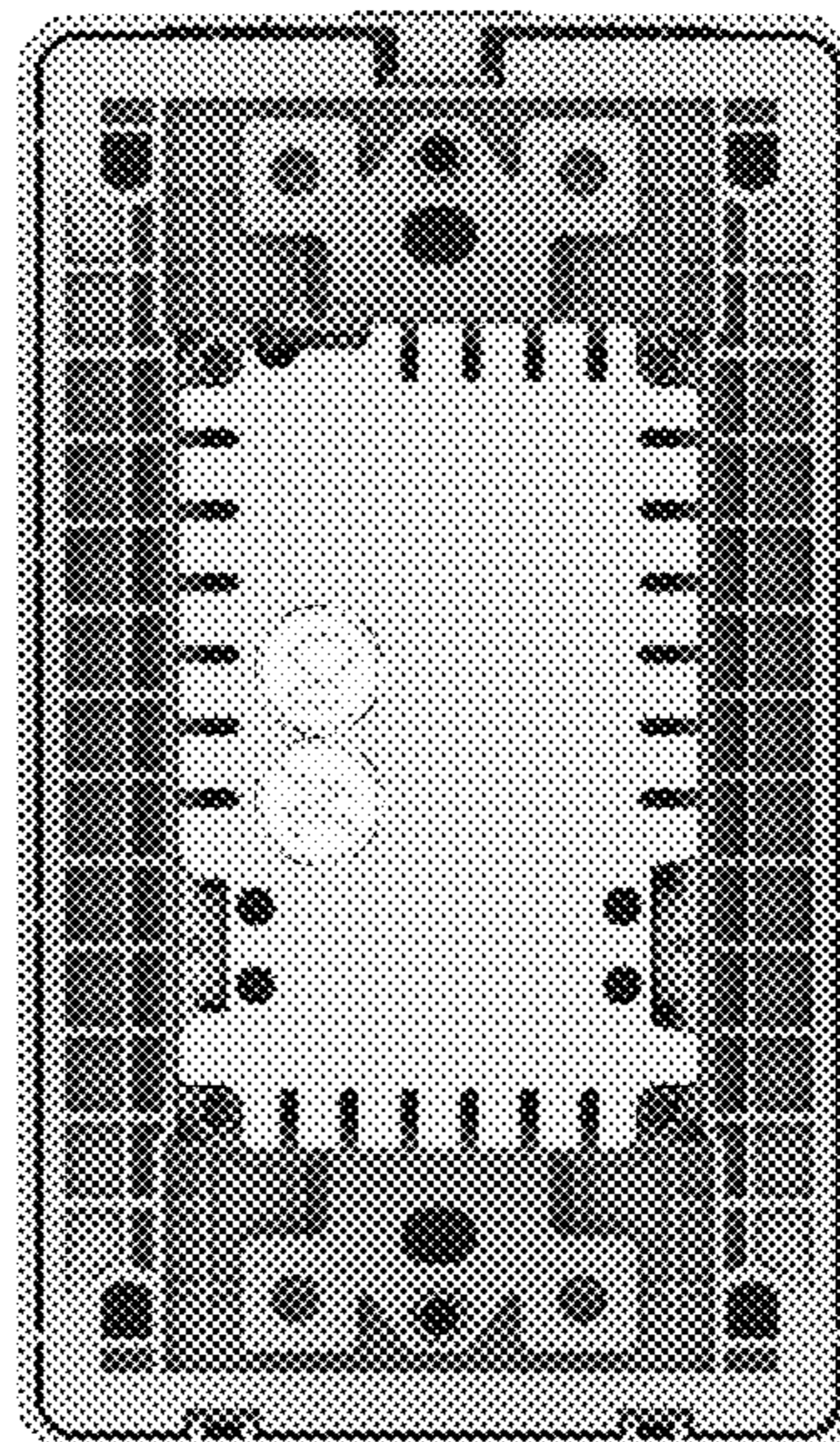
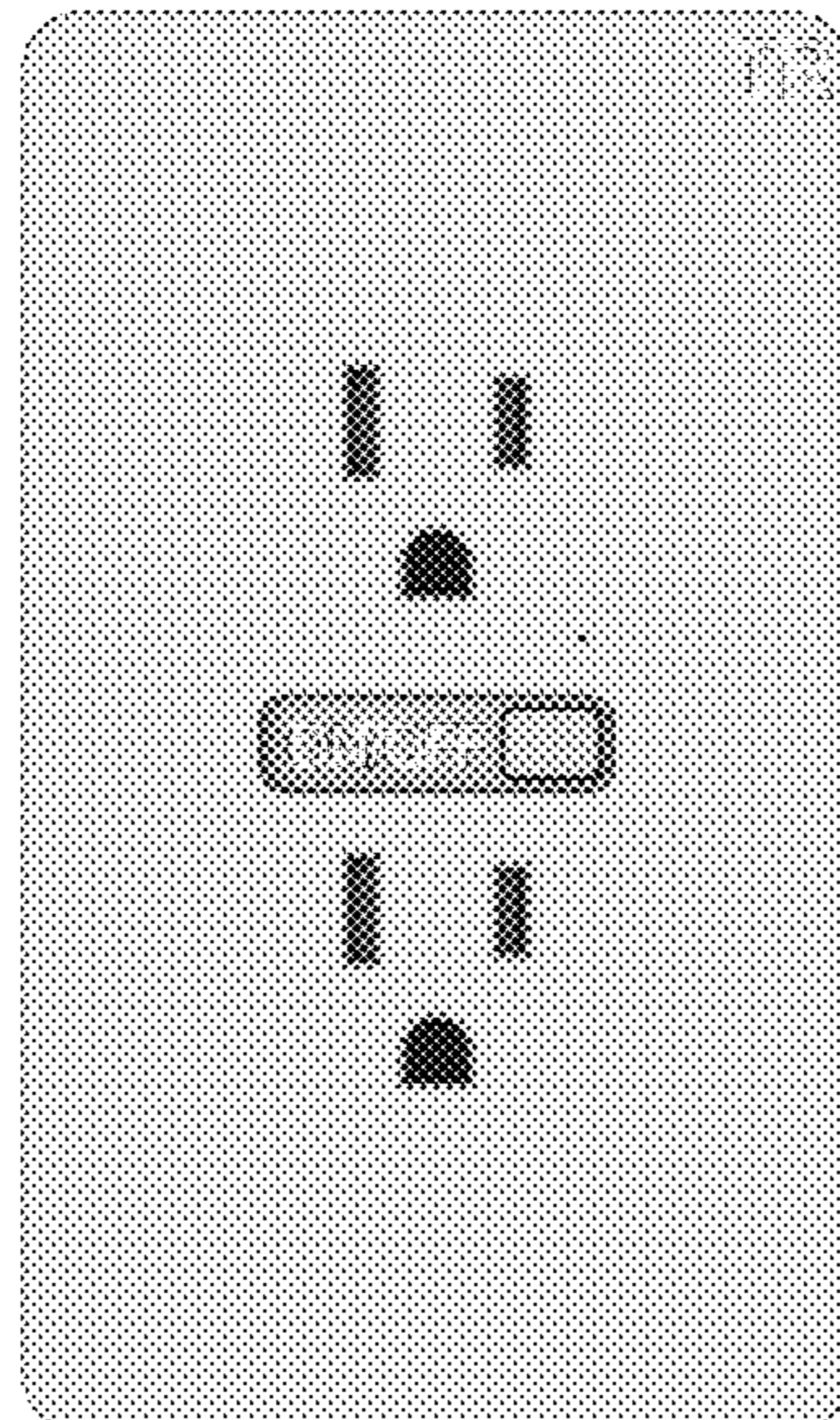

(56)

References Cited

U.S. PATENT DOCUMENTS

D826,860	S	*	8/2018	Iaconis	D13/139.1
10,840,688	B2		11/2020	Zhang et al.		
D916,667	S		4/2021	Fu et al.		
D948,448	S		4/2022	Ma et al.		
2014/0242830	A1		8/2014	Garofalo et al.		
2016/0204588	A1		7/2016	Trojanowski		

OTHER PUBLICATIONS

GE Z-wave 15-Amp Residential DUplex Smart Outlet. Lowe's. Oldest review date: Mar. 17, 2015. Retrieval date: Mar. 24, 2022. Retrieved from internet: <https://www.lowes.com/pd/GE-Z-wave-White-15-Amp-Duplex-Smart-Outlet-Residential-Outlet/50329997> (Year: 2015).*

Outlet USB Fast Charger 4.2A Duplex Receptacle. Ebay. Posted by aibocn. Posting date: Jun. 20, 2021. Retrieval date: Jun. 23, 2021. Retrieved from internet: <https://www.ebay.com/rvh/304039806490> (Year: 2021).

USB Outlet Fast Charger 4.8A Duplex Receptacle. Ebay. Posted by micmi-com. Posting date: May 26, 2019. Retrieval date: Jun. 23, 2021. Retrieved from internet: <https://www.ebay.com/itm/283186935369> (Year: 2019).

Type C USB Outlet Fast Charger 4.2A Duplex Receptacle. Ebay. Posted by micmi-com. Posting date: Jan. 11, 2021. Retrieval date:

Jun. 23, 2021. Retrieved from internet: <https://www.ebay.com/itm/283819679814> (Year: 2021).

2 4A USB Wall Outlet (2-Pack)—White, by Dynex. BestBuy. Oldest review date: 2018. Retrieval date: Jun. 23, 2021. Retrieved from internet: <https://www.bestbuy.com/site/dynex-2-4a-usb-wall-outlet-2-pack-white/5834701.p?skuId=5834701> (Year: 2018).

3.6A USB Charger Wall Outlet—White, by Insignia. BestBuy. Oldest review date: 2017. Retrieval date: Jun. 23, 2021. Retrieved from internet: <https://www.bestbuy.com/site/insignia-3-6a-usb-charger-wall-outlet-white/5489800.p?skuId=5489800> (Year: 2017).

Embrighten 55256 Z-Wave Plus Smart Receptacle. Amazon. Oldest review date: Jul. 15, 2017. Retrieval date: Mar. 24, 2022. Retrieved from internet: <https://www.amazon.com/Embrighten-55256-Receptacle-Assistant-Tamper-Resistant/dp/B07361JZ2H> <<https://www.amazon.com/Embrighten-55256-Receptacle-Assistant-Tamper-Resistant/dp/B07361JZ2H>> Year: 2017).

Leviton DW15R-1BW Decora Smart Wi-Fi Tamper Resistant Outlet. Amazon. Oldest review date: Feb. 3, 2020. Retrieval date: Mar. 24, 2022. Retrieved from internet: <<https://www.amazon.com/Leviton-DW15R-1BW-Resistant-Required-Assistant/dp/B088P5LSD4>> (Year: 2020).

GFCI Outlet Tamper Resistant Receptacle with LED indicator by micmi. Amazon. Oldest review date: Apr. 9, 2019. Retrieval date: Mar. 24, 2022. Retrieved from internet: <<https://www.amazon.com/Resistant-Receptacle-Indicator-Wallplate-MICMI/dp/B07MCSXV5M>> (Year: 2019).

* cited by examiner

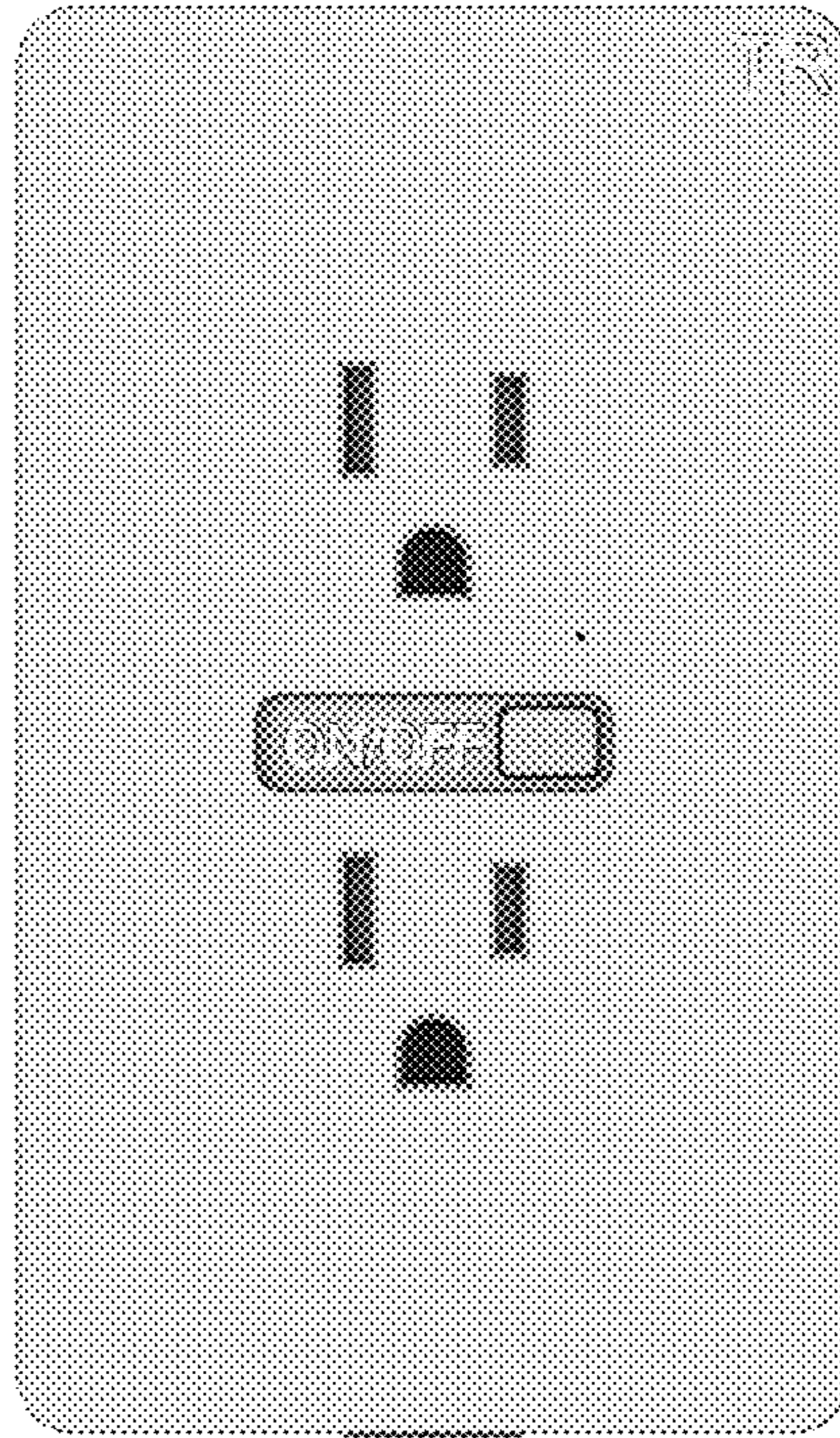

FIG. 1

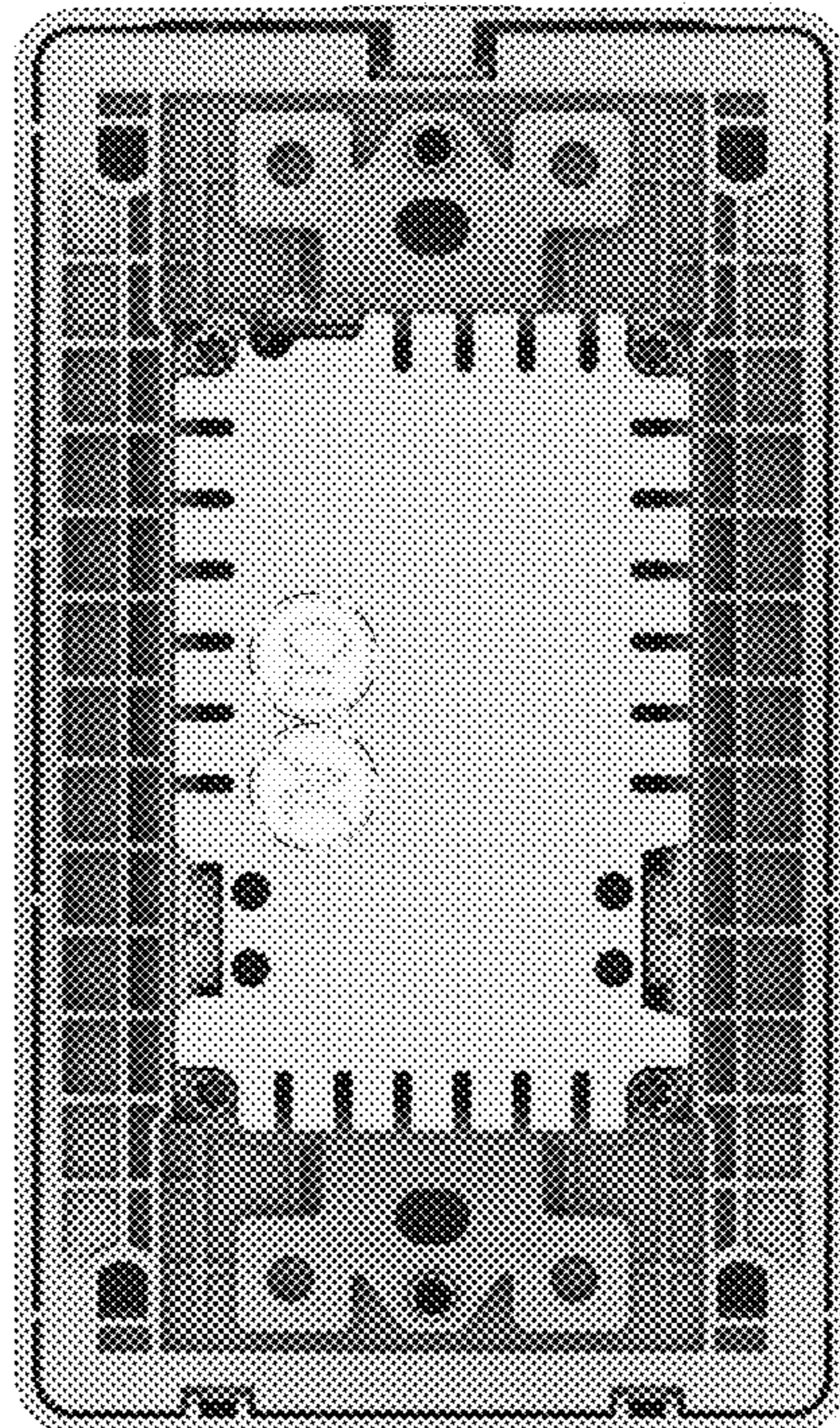

FIG. 2

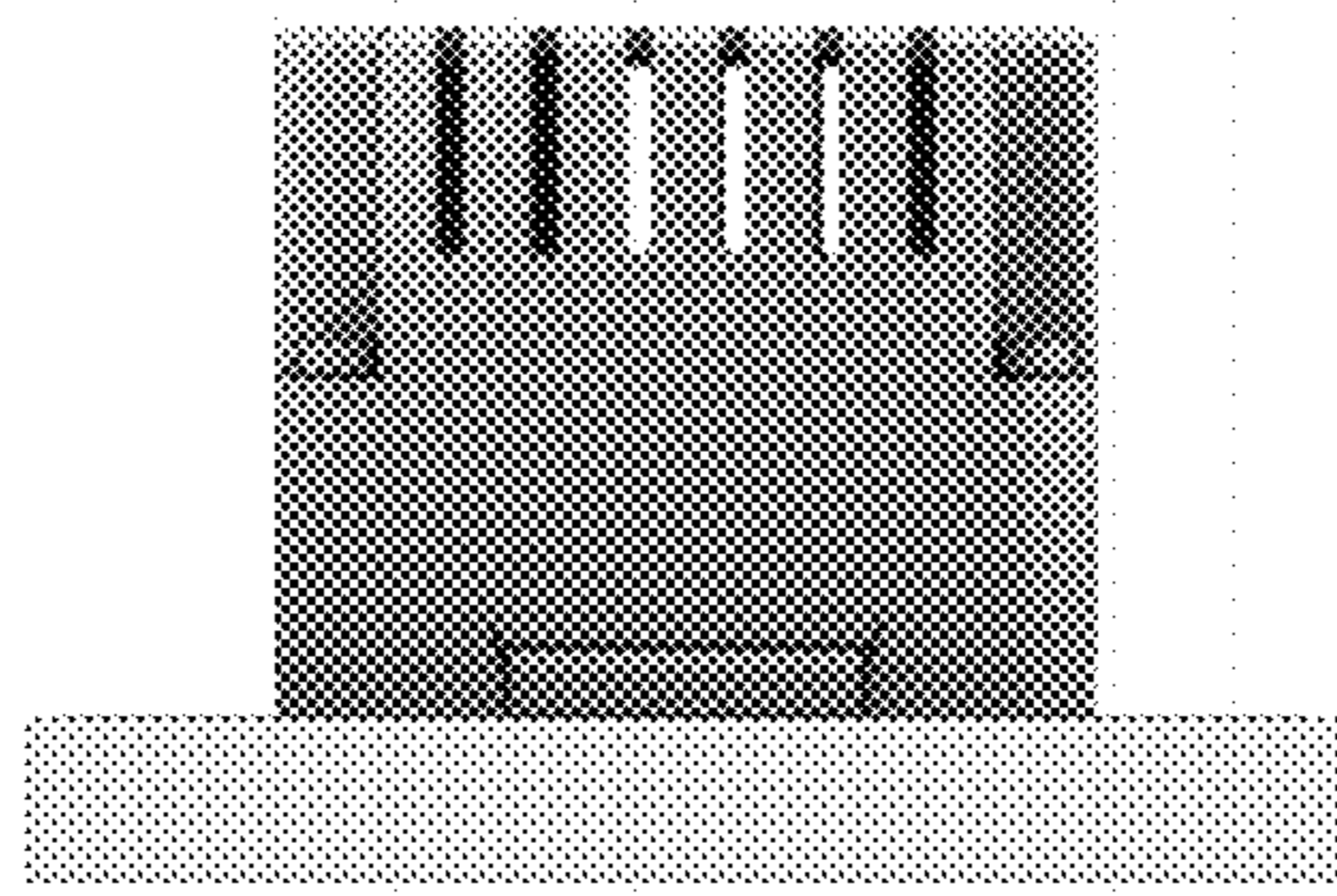

FIG. 3

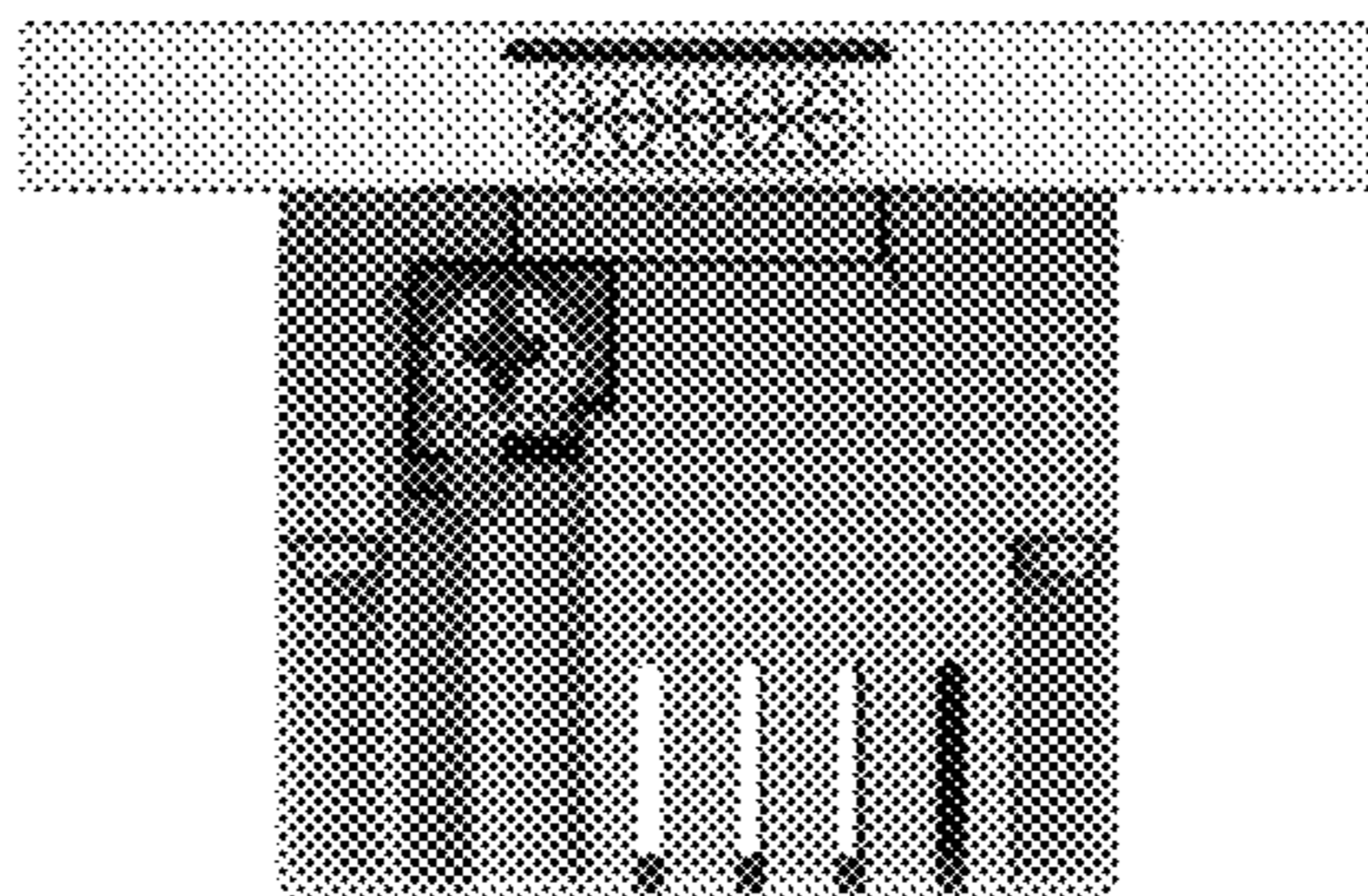

FIG. 4

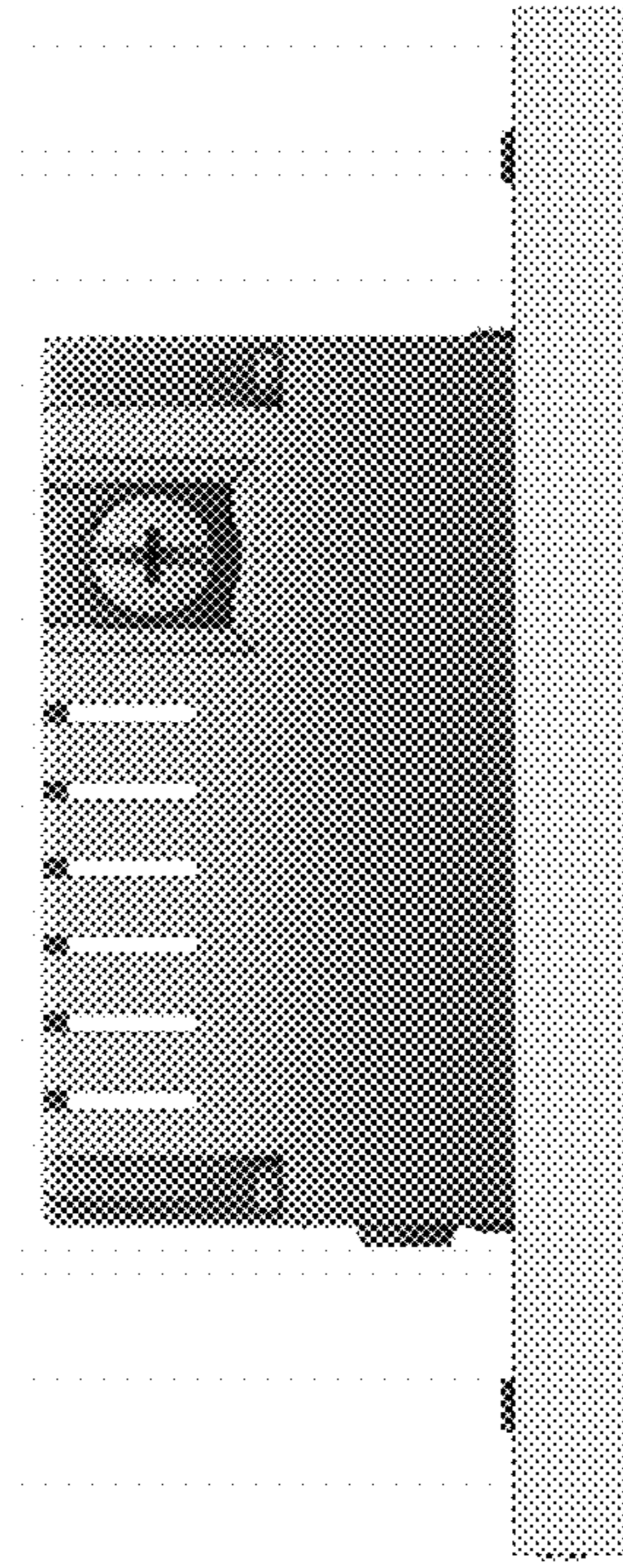

FIG. 5

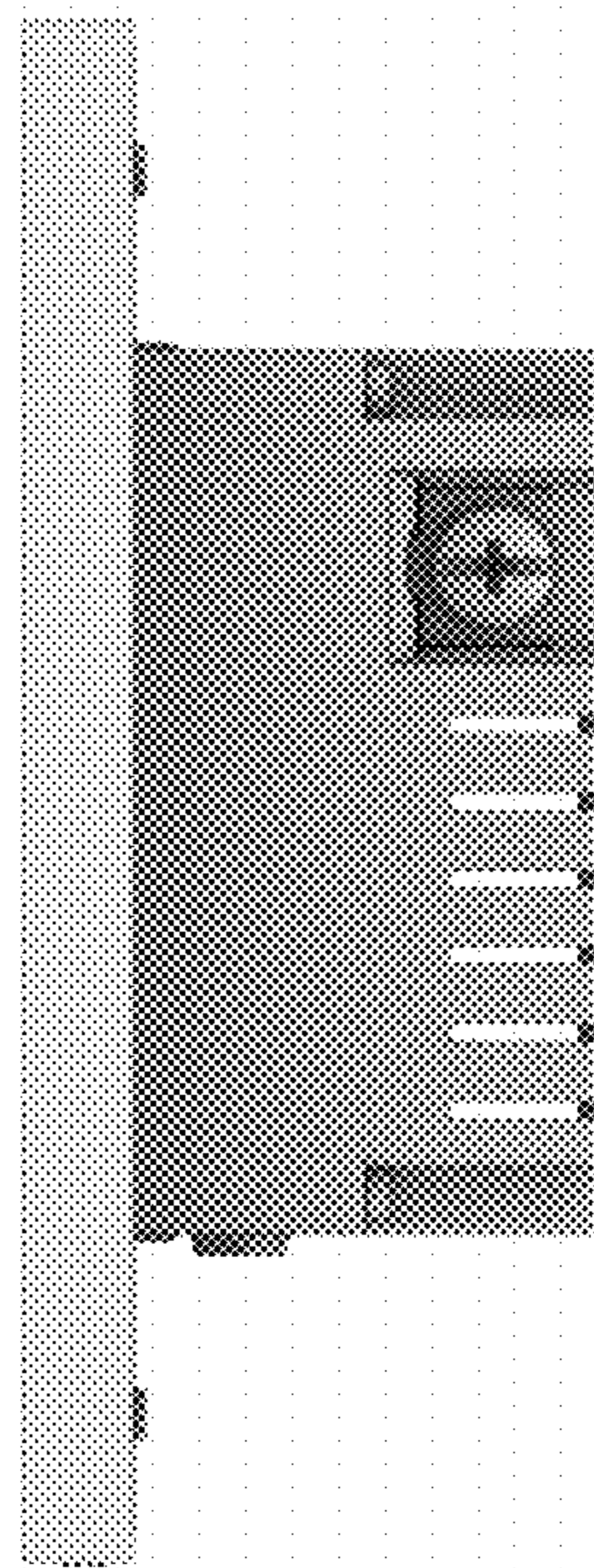

FIG. 6

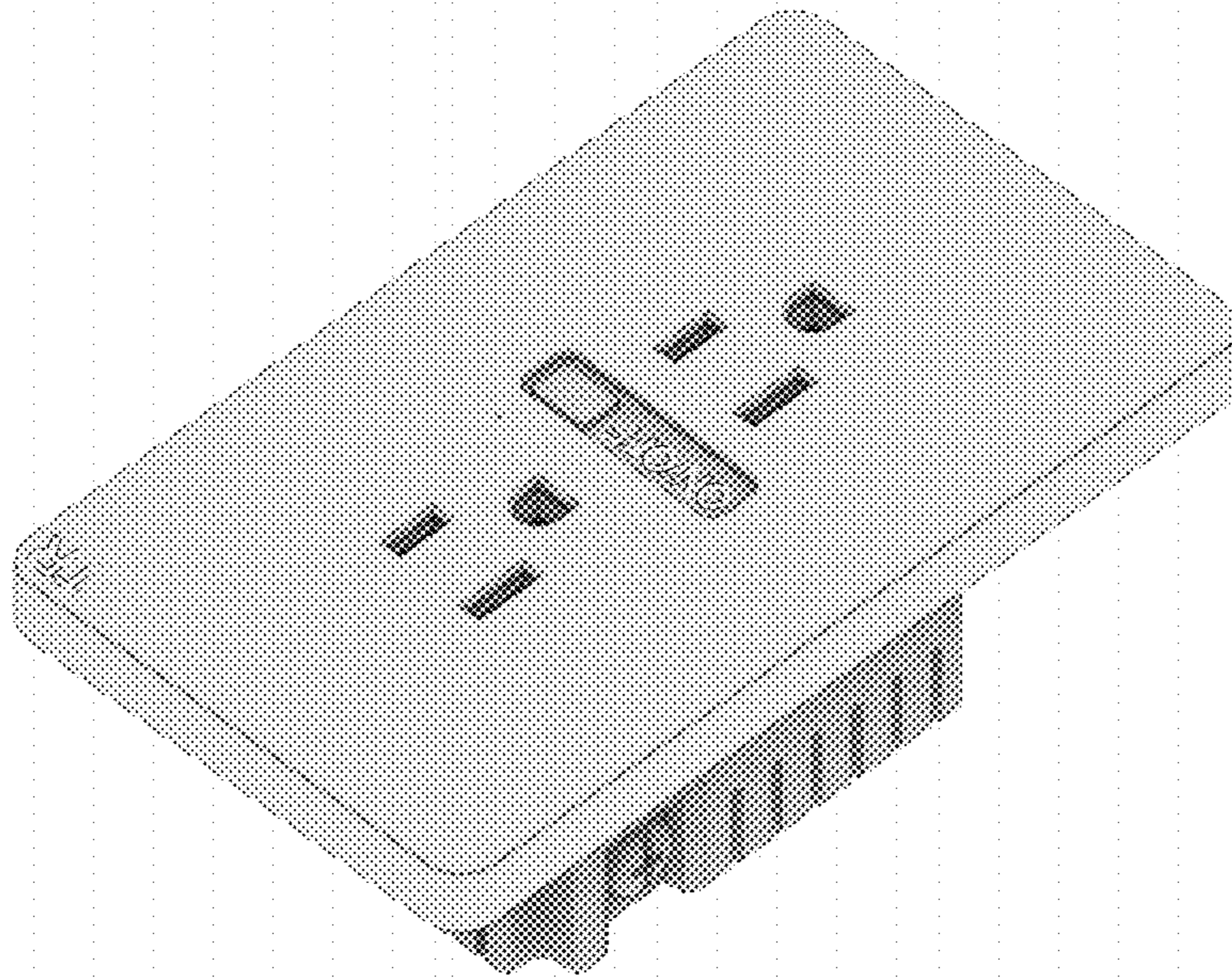

FIG. 7

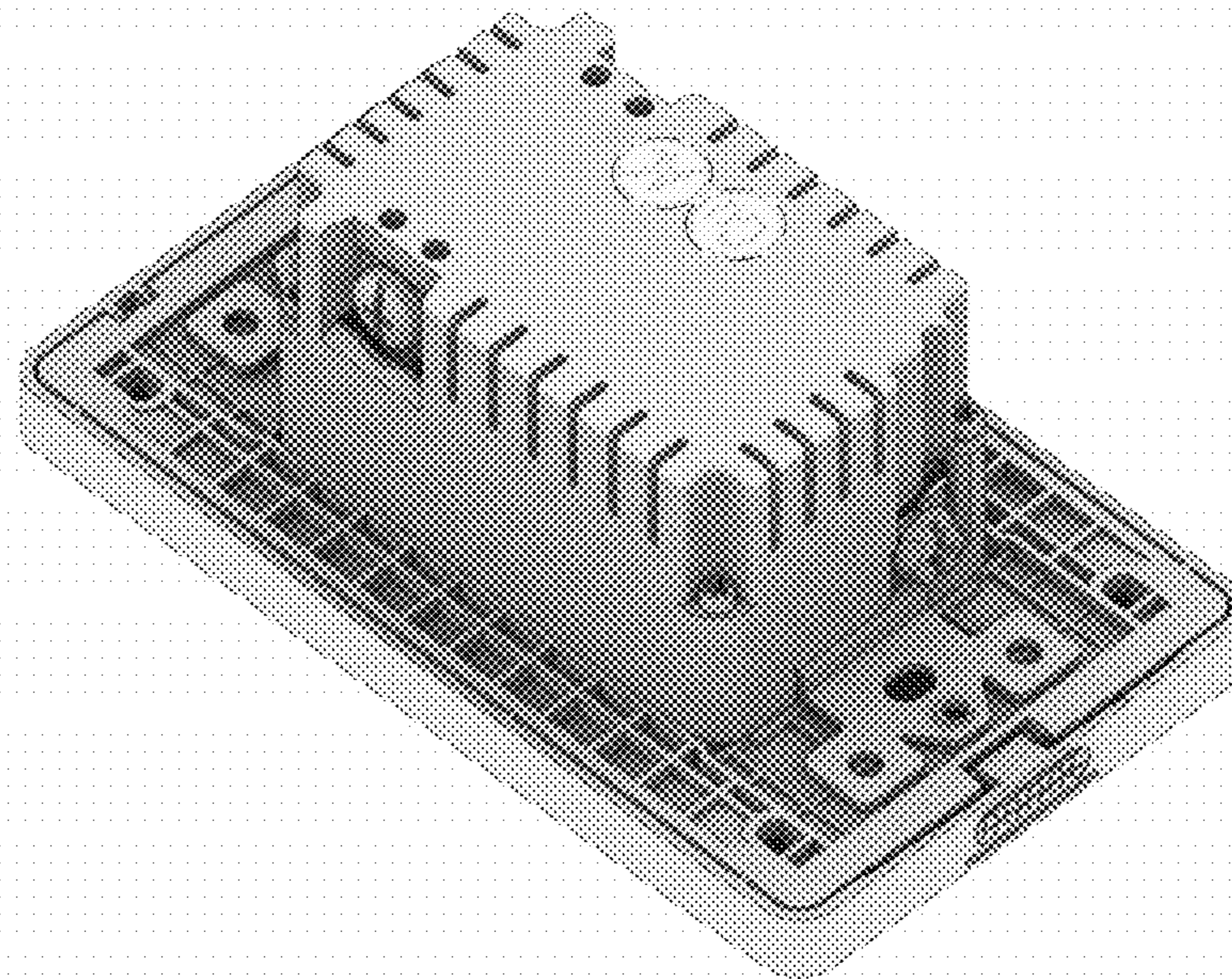

FIG. 8