



US00D971804S

(12) **United States Design Patent** (10) **Patent No.:** **US D971,804 S**
Akcaay (45) **Date of Patent:** **** Dec. 6, 2022**

(54) **VEHICLE BUMPER UNIT**
(71) Applicant: **VOLKSWAGEN AKTIENGESELLSCHAFT, Wolfsburg (DE)**
(72) Inventor: **Cihan Akcaay, Wolfsburg (DE)**
(73) Assignee: **VOLKSWAGEN AKTIENGESELLSCHAFT, Wolfsburg (DE)**
(**) Term: **15 Years**

D877,668 S * 3/2020 Bucher D12/169
D885,994 S * 6/2020 Metros D12/163
D887,317 S * 6/2020 Metros D12/163
D901,342 S * 11/2020 Yang D12/163
D902,093 S * 11/2020 Behmer D12/163
D910,503 S * 2/2021 Battams D12/163
D911,231 S * 2/2021 Bucher D12/169
D914,554 S * 3/2021 Bischoff D12/169
D915,957 S * 4/2021 Bischoff D12/169
D932,388 S * 10/2021 Montoya Bueloni D12/169
D932,391 S * 10/2021 Montoya Bueloni D12/169
D932,392 S * 10/2021 Akcaay D12/169
D932,396 S * 10/2021 Giumentaro D12/169
D934,751 S * 11/2021 Taubert D12/169
D939,401 S * 12/2021 Becker D12/169

(21) Appl. No.: **29/786,144**
(22) Filed: **May 28, 2021**
(30) **Foreign Application Priority Data**
Apr. 9, 2021 (WO) WIPO103411
(51) **LOC (13) Cl.** **12-16**
(52) **U.S. Cl.** **D12/169**
USPC **D12/169**
(58) **Field of Classification Search**
USPC D12/169, 196, 86, 90-92, 163, 190, 98,
D12/164; 293/102, 113, 115, 117, 120,
293/193.11; 296/180.1, 180.2
CPC B60R 19/02; B60R 19/04; B62D 25/08
See application file for complete search history.

FOREIGN PATENT DOCUMENTS

WO 103826 11/2018

* cited by examiner

Primary Examiner — Melody N Brown
(74) *Attorney, Agent, or Firm* — Lucas & Mercanti, LLP;
Klaus P. Stoffel

(57) **CLAIM**

The ornamental design for a vehicle bumper unit, as shown and described.

DESCRIPTION

FIG. 1 is a front and left side perspective view of a vehicle bumper unit showing my new design;
FIG. 2 is a rear and right side perspective view thereof;
FIG. 3 is a front view thereof;
FIG. 4 is a rear view thereof;
FIG. 5 is a left side view thereof;
FIG. 6 is a right side view thereof;
FIG. 7 is a bottom view thereof; and,
FIG. 8 is a top view thereof.

1 Claim, 4 Drawing Sheets

(56) **References Cited**
U.S. PATENT DOCUMENTS
D600,602 S * 9/2009 Endoh D12/169
D664,904 S * 8/2012 Koyama D12/169
D708,997 S * 7/2014 Koizumi D12/169
D736,683 S * 8/2015 Glover D12/169
D843,898 S * 3/2019 Luk D12/169
D855,502 S * 8/2019 Behmer D12/163

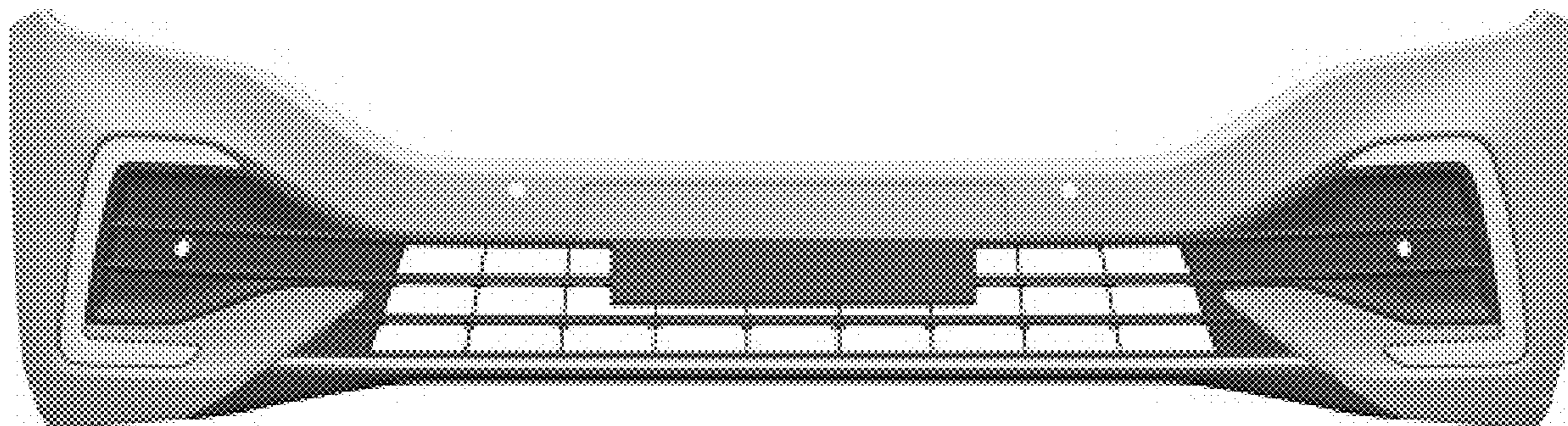

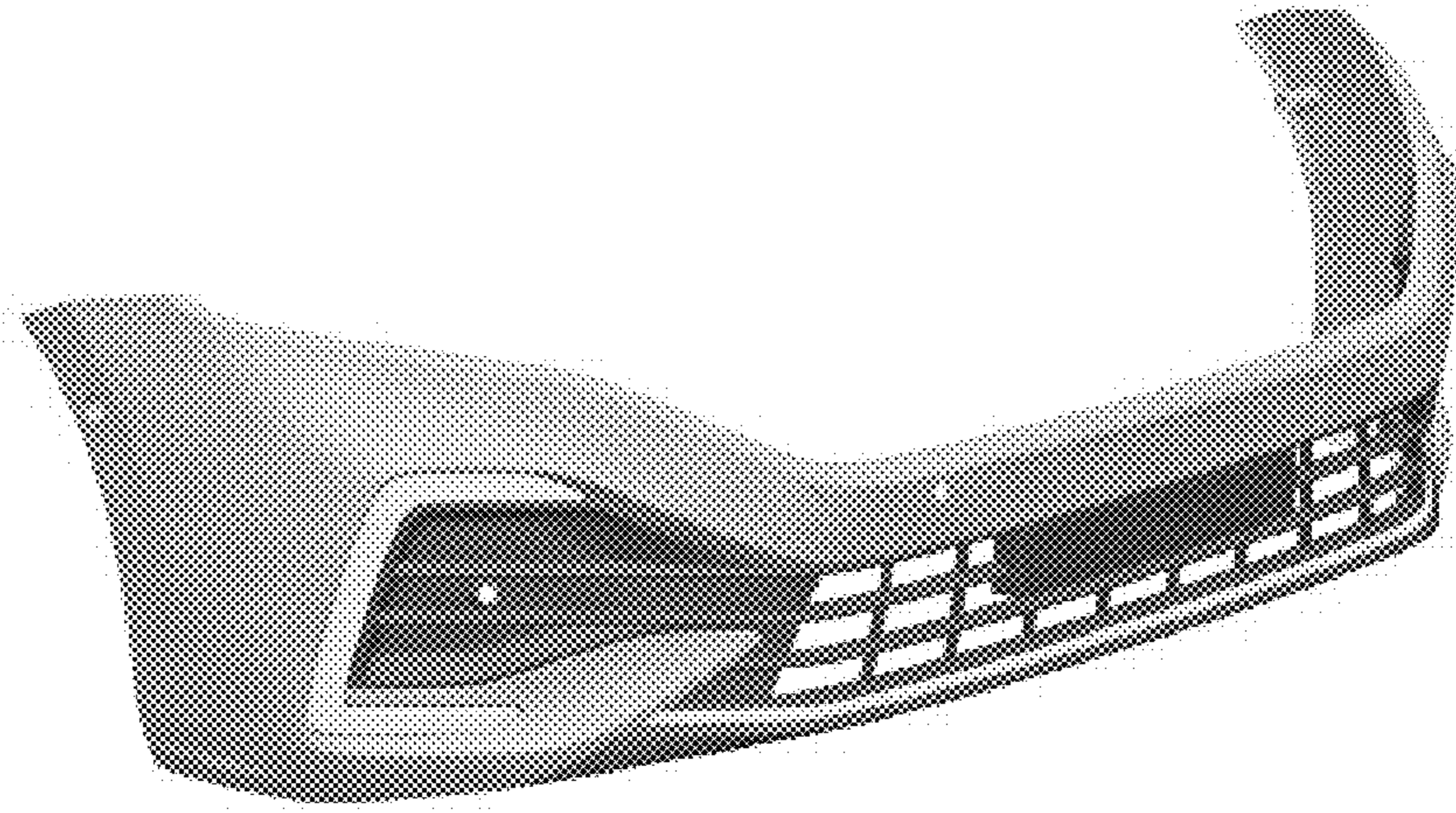

Fig. 1

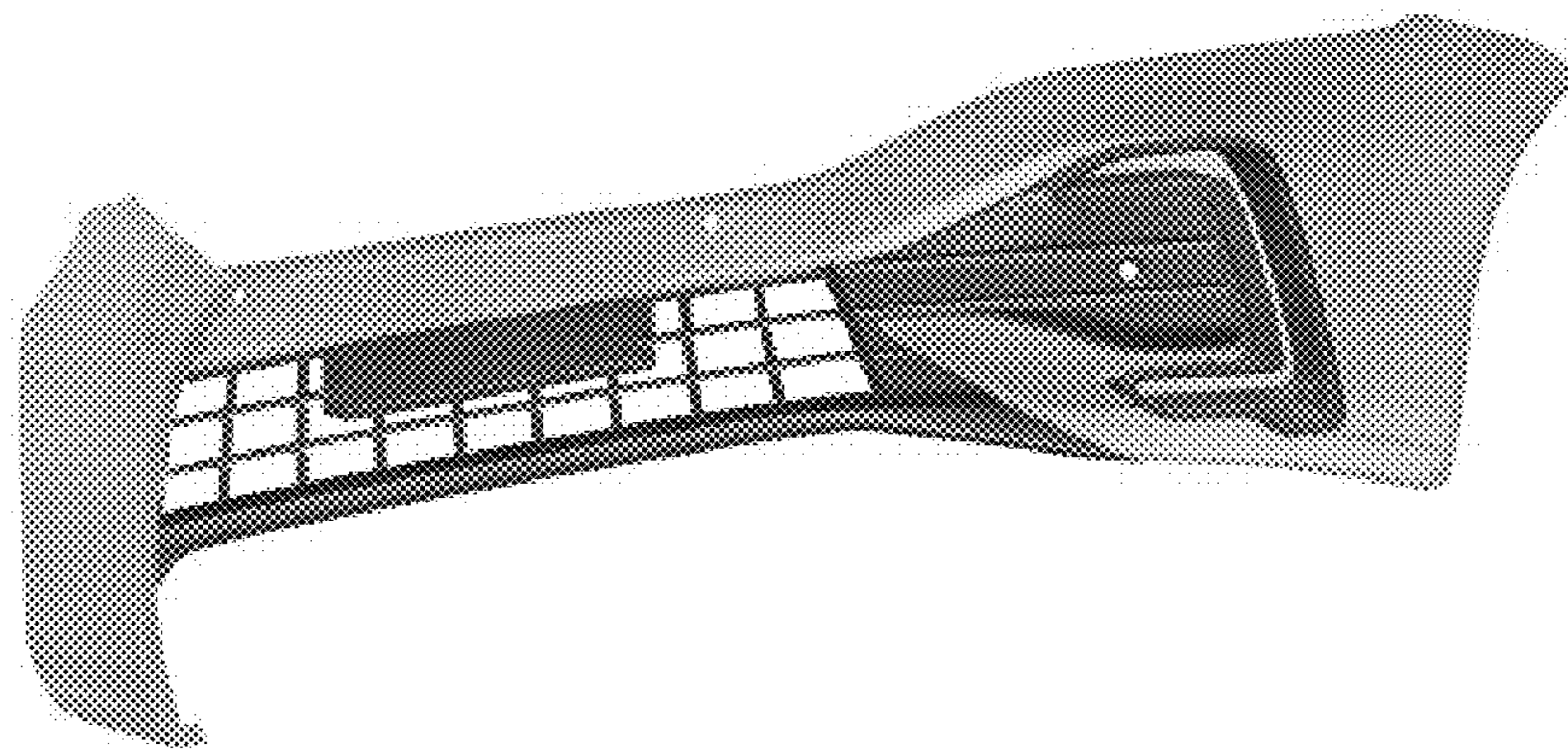

Fig. 2

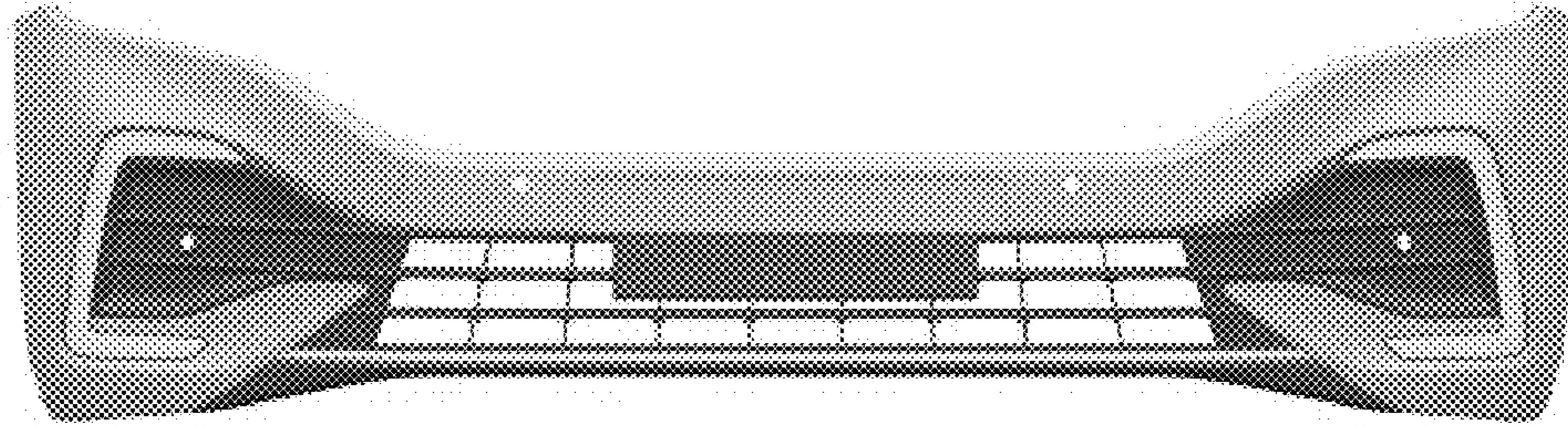

Fig. 3

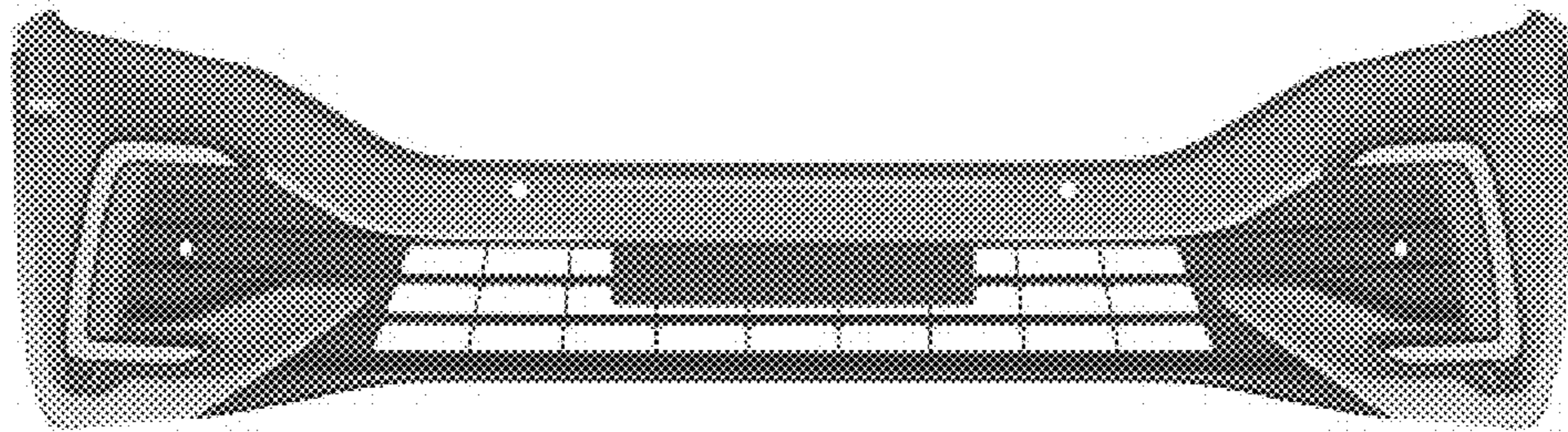

Fig. 4

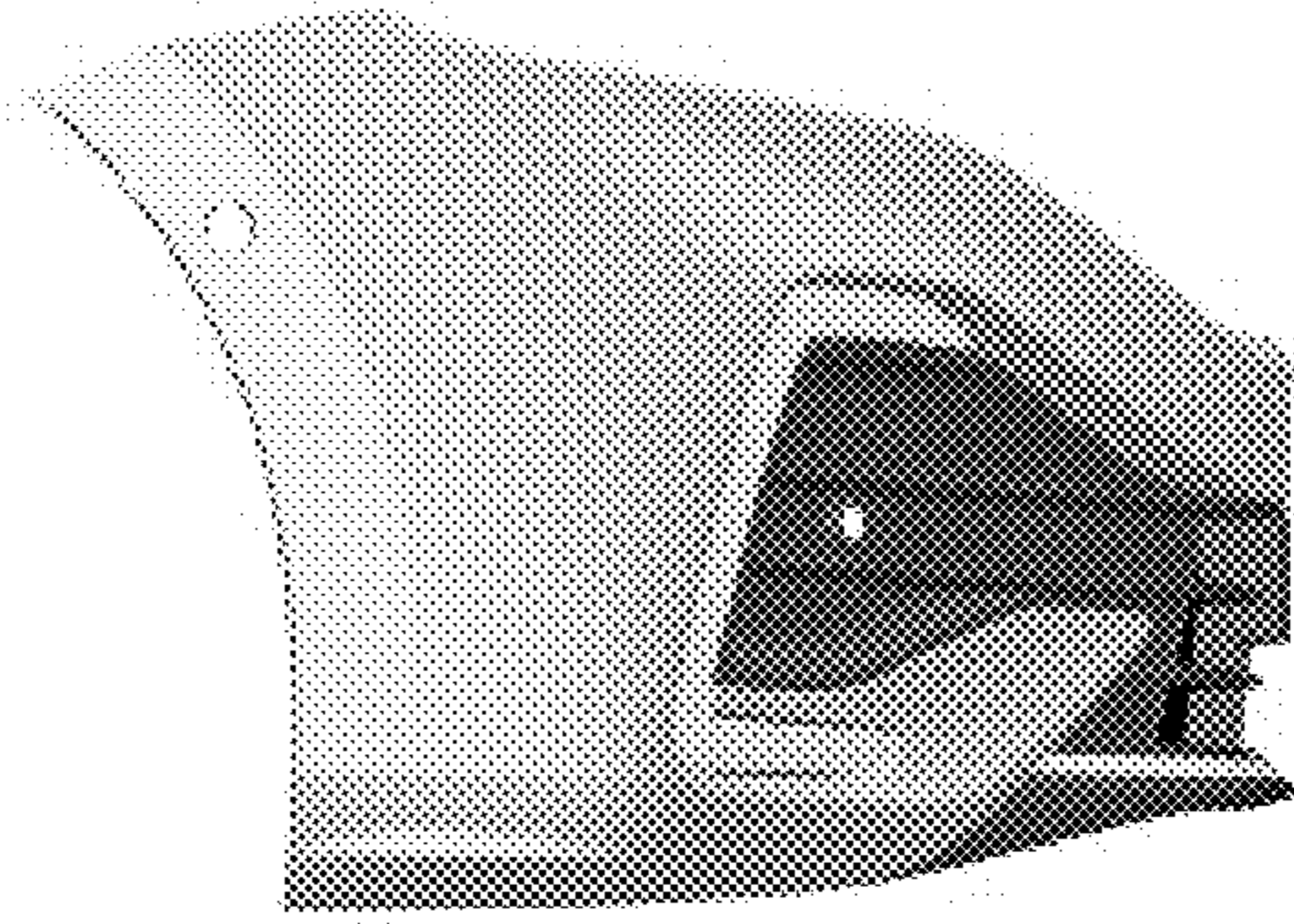

Fig. 5

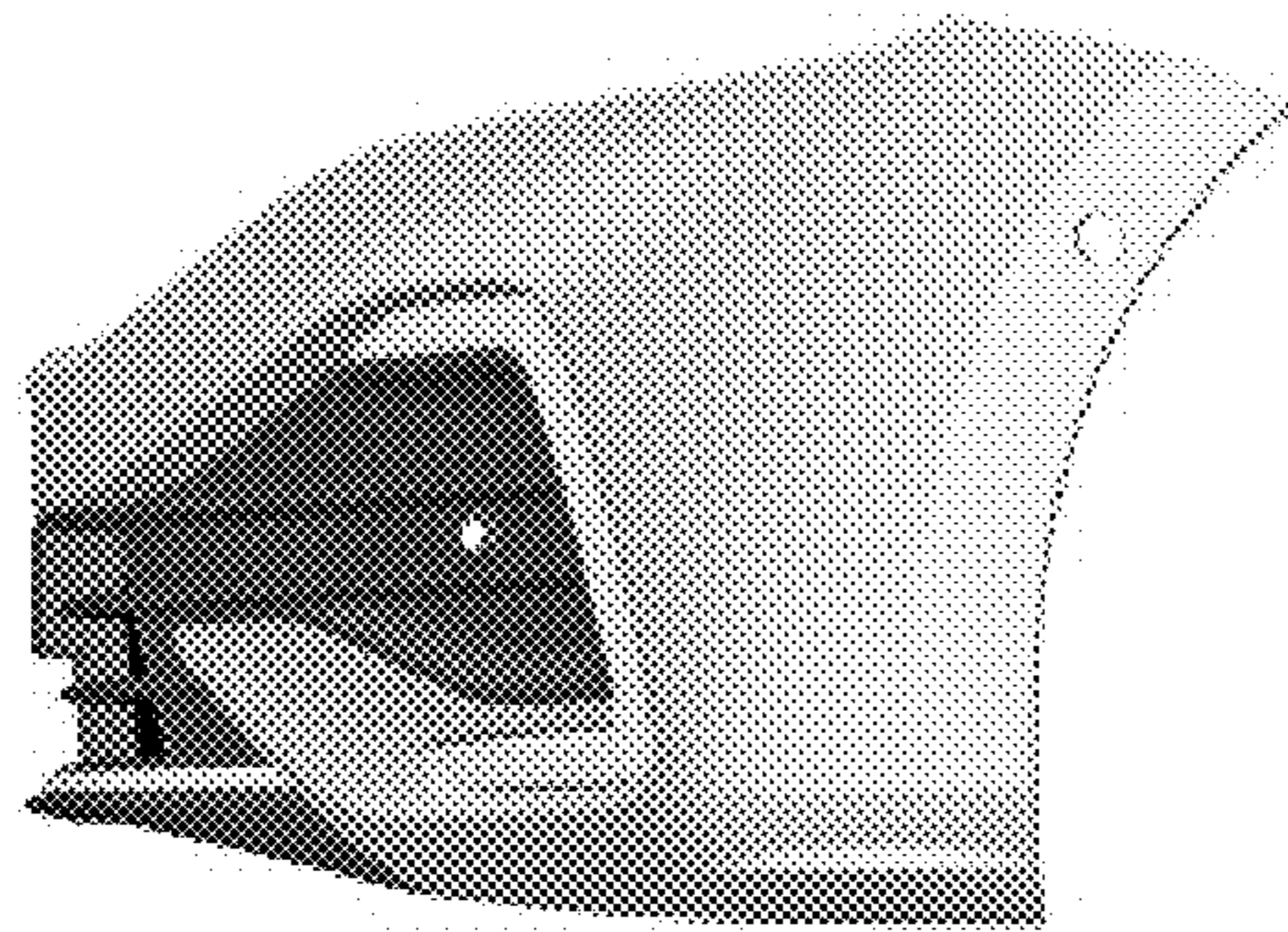

Fig. 6

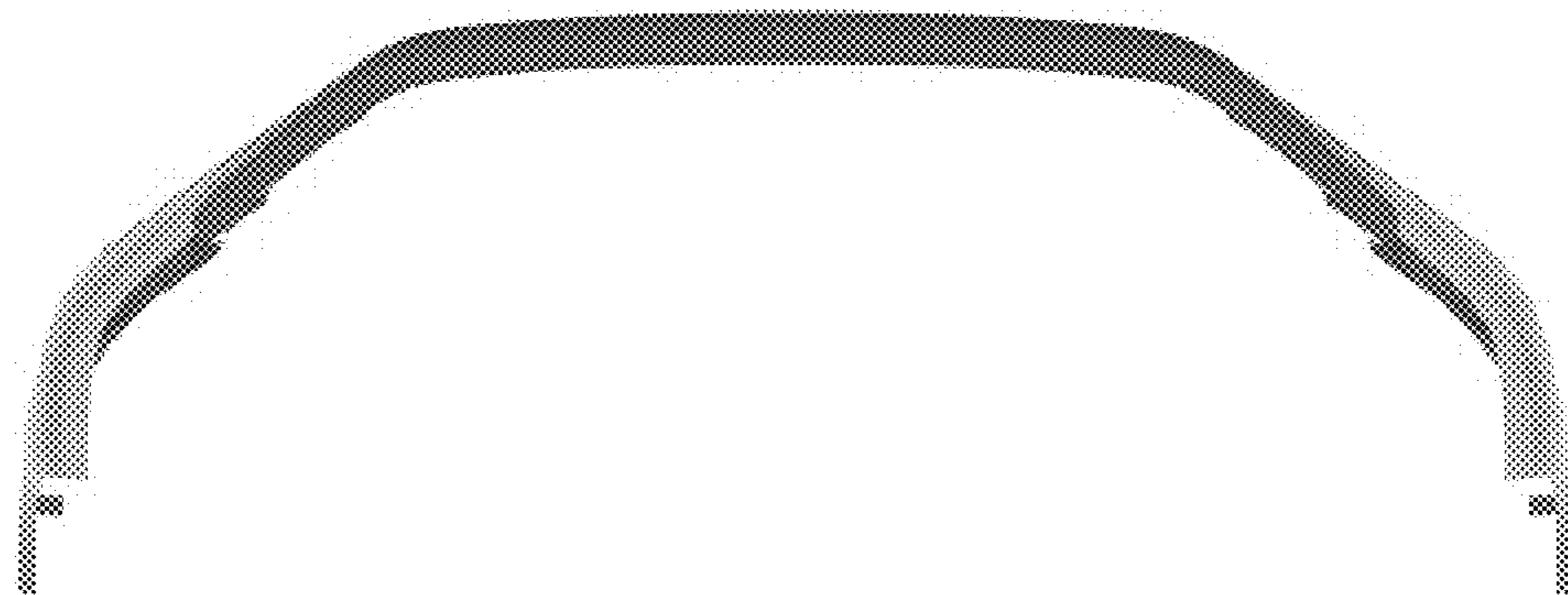

Fig. 7

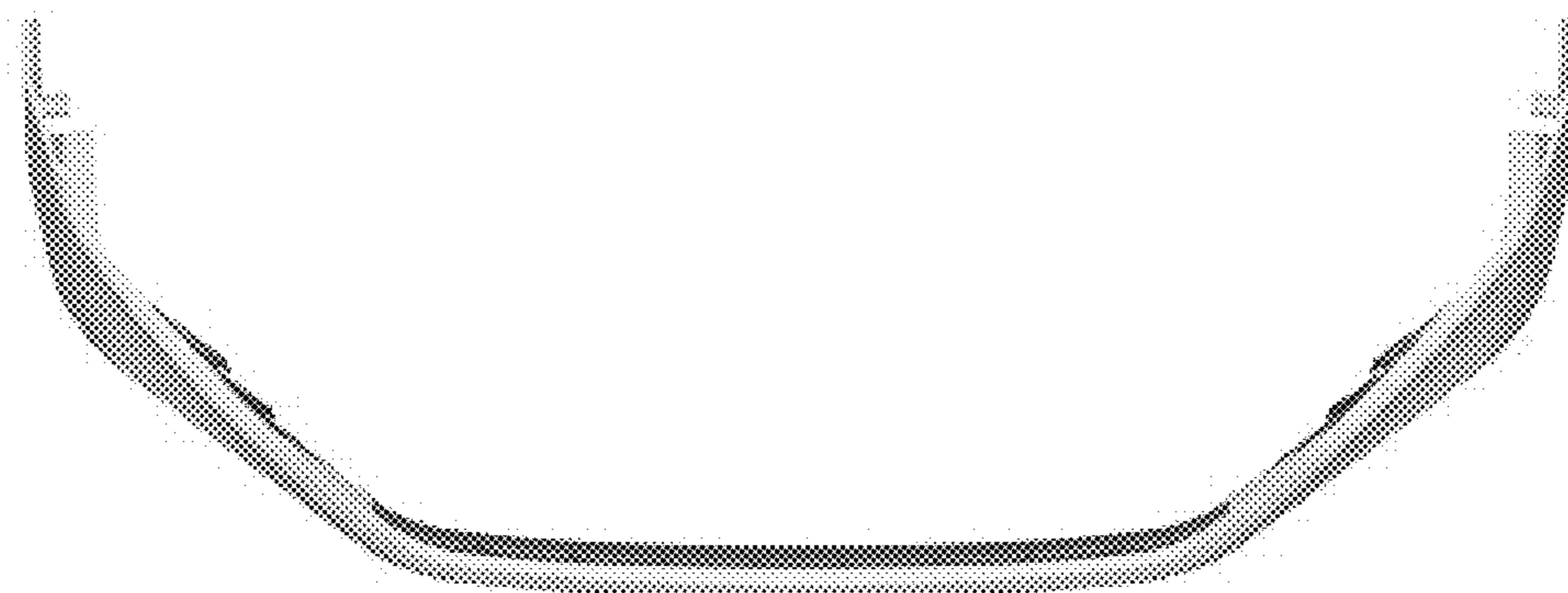

Fig. 8