



US00D971796S

(12) **United States Design Patent** (10) **Patent No.:** **US D971,796 S**
Akçay (45) **Date of Patent:** **** Dec. 6, 2022**

(54) **RADIATOR GRILLE FOR VEHICLE**

(71) Applicant: **VOLKSWAGEN AKTIENGESELLSCHAFT, Wolfsburg (DE)**

(72) Inventor: **Cihan Akçay, Wolfsburg (DE)**

(73) Assignee: **VOLKSWAGEN AKTIENGESELLSCHAFT, Wolfsburg (DE)**

(**) Term: **15 Years**

(21) Appl. No.: **29/786,088**

(22) Filed: **May 28, 2021**

(30) **Foreign Application Priority Data**

Apr. 9, 2021 (WO) WIPO103391

(51) **LOC (13) Cl.** **12-16**

(52) **U.S. Cl.**
USPC **D12/163**

(58) **Field of Classification Search**
USPC D12/163, 196, 86, 90-92, 169, 190, 98,
D12/164; 293/193.11; 180/68.1, 68.6
CPC B62B 9/16; B60K 11/08; B62D 25/08;
B60R 19/52
See application file for complete search history.

(56) **References Cited**

U.S. PATENT DOCUMENTS

D819,507 S * 6/2018 Bridan D12/163
D841,519 S * 2/2019 Bischoff D12/91
D844,501 S * 4/2019 Tamura D12/163

D859,213 S * 9/2019 Bischoff D12/91
D860,868 S * 9/2019 Bischoff D12/92
D867,229 S * 11/2019 Morikawa D12/163
D908,553 S * 1/2021 Bischoff D12/163
D911,883 S * 3/2021 Bae D12/163
D932,954 S * 10/2021 Akçay D12/163
D935,353 S * 11/2021 Giumentaro D12/163
D939,358 S * 12/2021 Hammi D9/709
D950,418 S * 5/2022 Giumentaro D12/91
D964,809 S * 9/2022 Bornfleth D7/553.5
D964,891 S * 9/2022 Kabañ D12/91

FOREIGN PATENT DOCUMENTS

WO DM103826 11/2018

* cited by examiner

Primary Examiner — Melody N Brown

(74) *Attorney, Agent, or Firm* — Lucas & Mercanti, LLP;
Klaus P. Stoffel

(57) **CLAIM**

The ornamental design for a radiator grille for vehicle, as shown and described.

DESCRIPTION

FIG. 1 is a front and left side perspective view of a radiator grille for vehicle showing my new design;
FIG. 2 is a rear and right side perspective view thereof;
FIG. 3 is a front view thereof;
FIG. 4 is a rear view thereof;
FIG. 5 is a left side view thereof;
FIG. 6 is a right side view thereof;
FIG. 7 is a bottom view thereof; and,
FIG. 8 is a top view thereof.

1 Claim, 4 Drawing Sheets

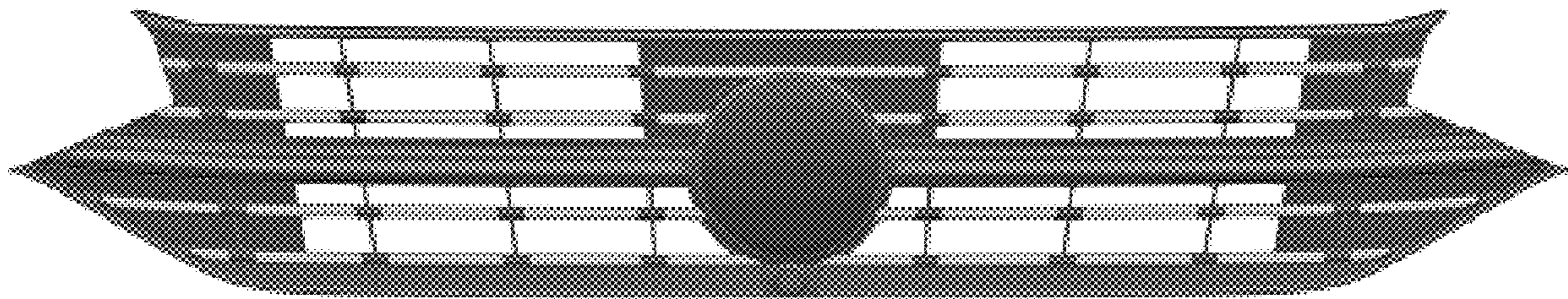

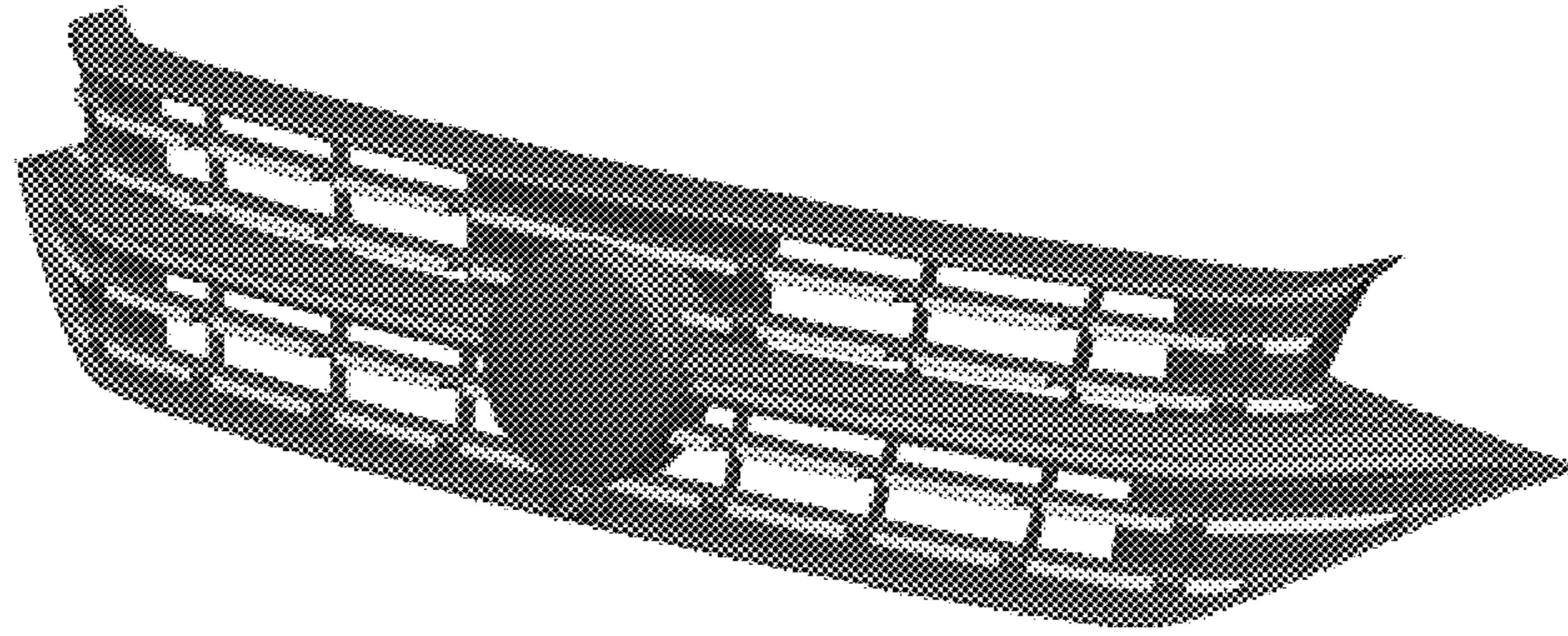

Fig. 1

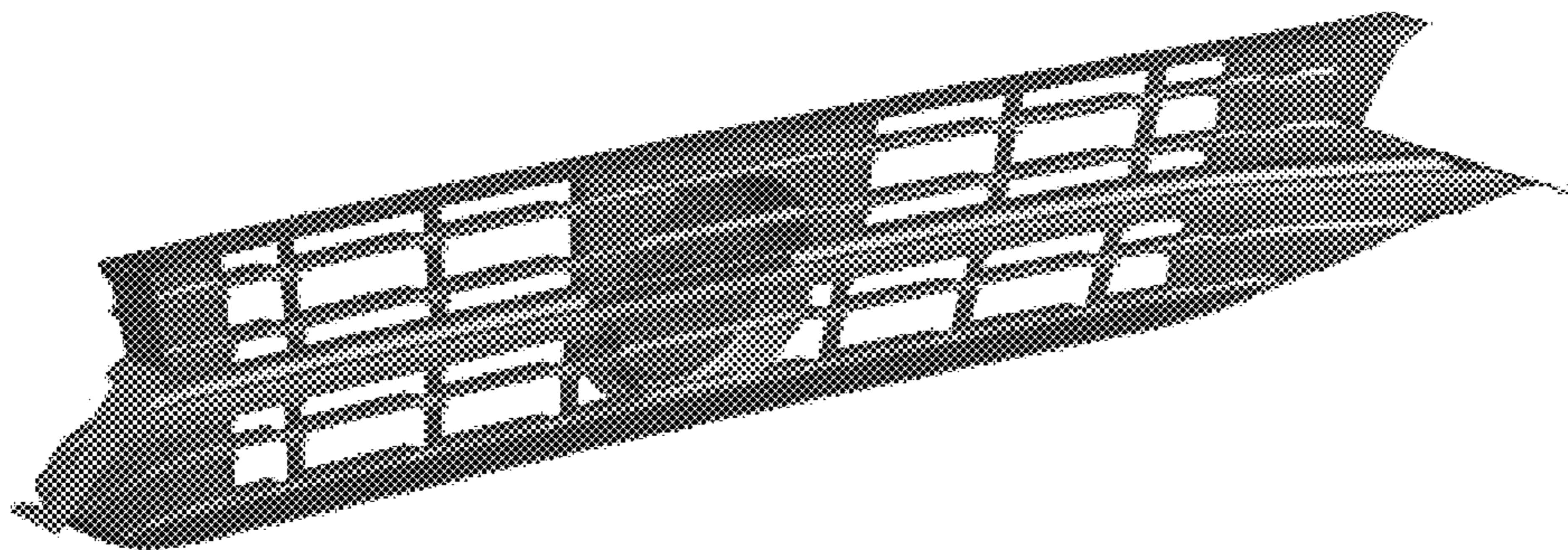

Fig. 2

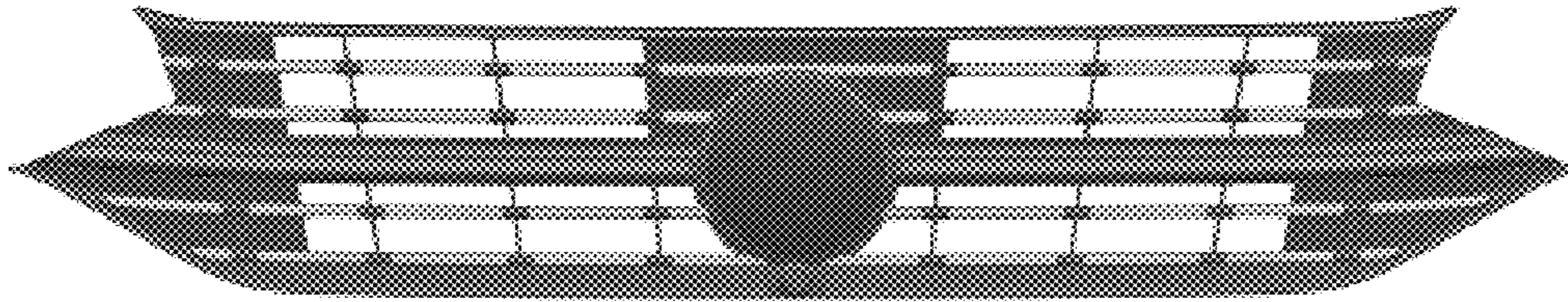

Fig. 3

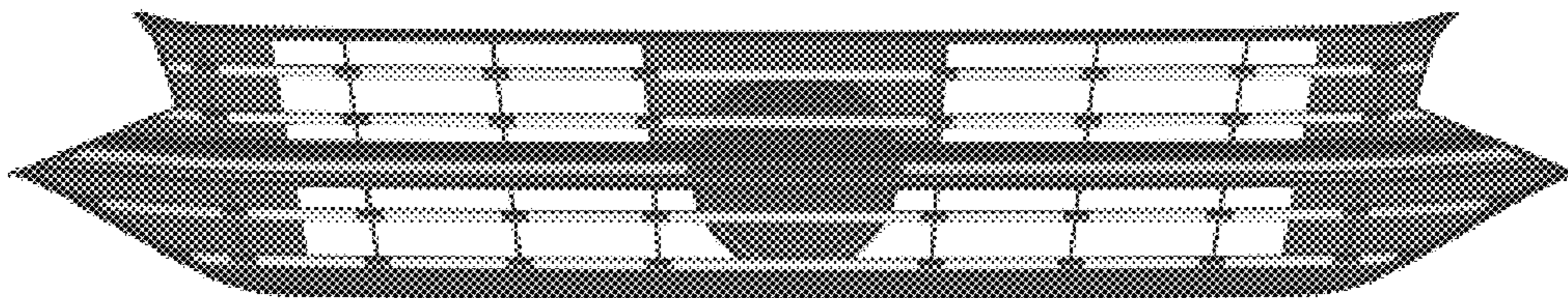

Fig. 4

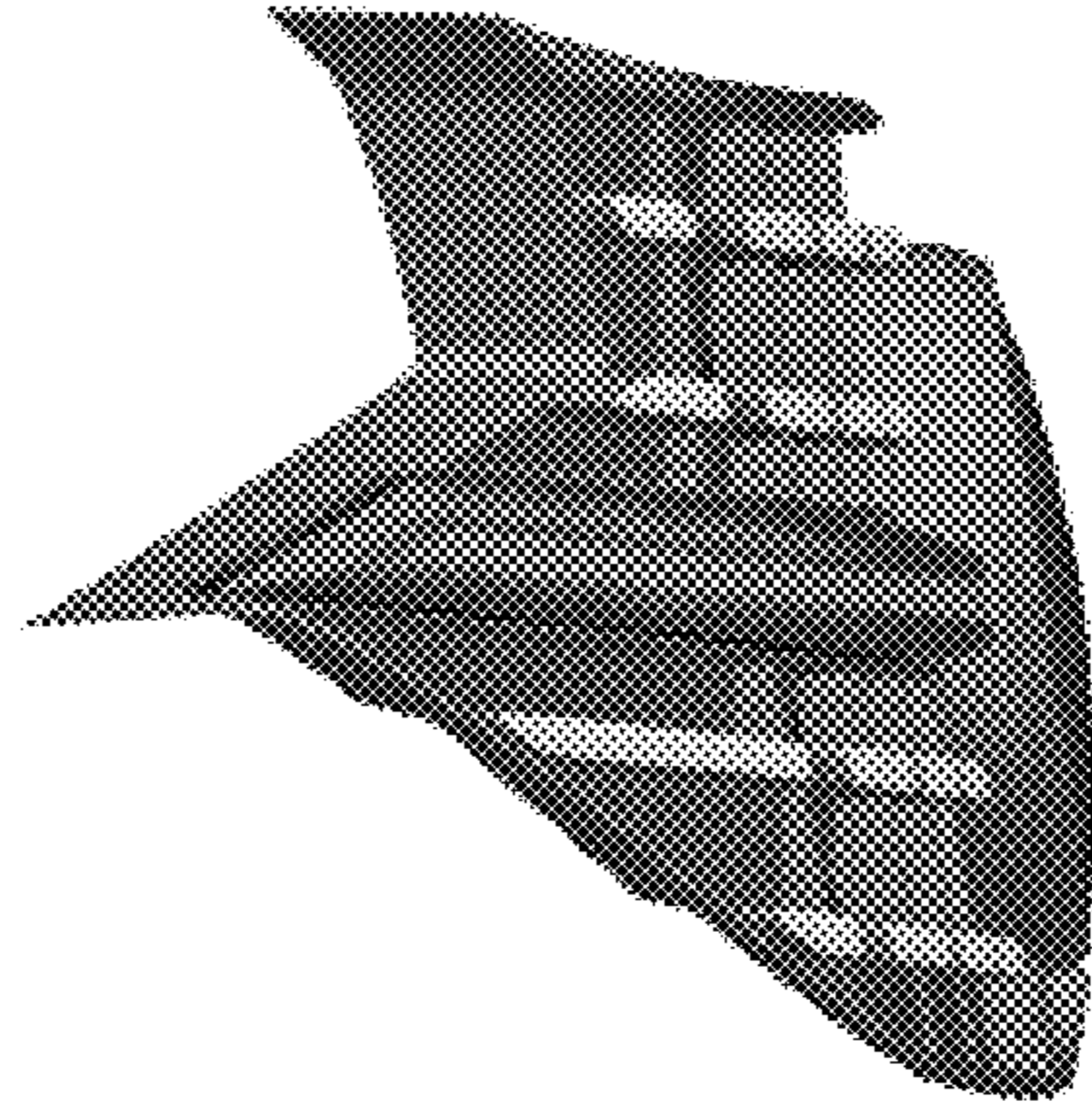

Fig. 5

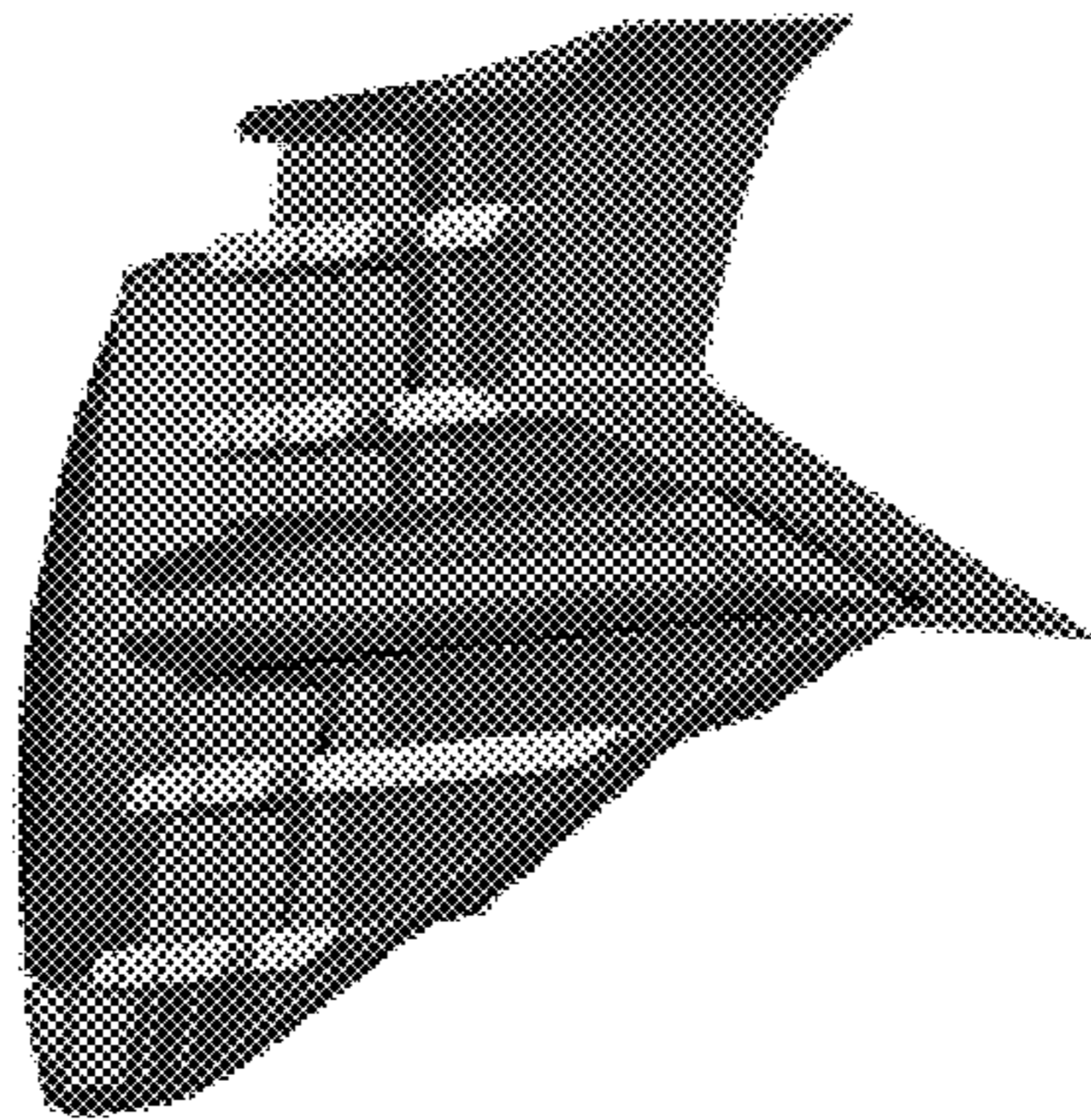

Fig. 6

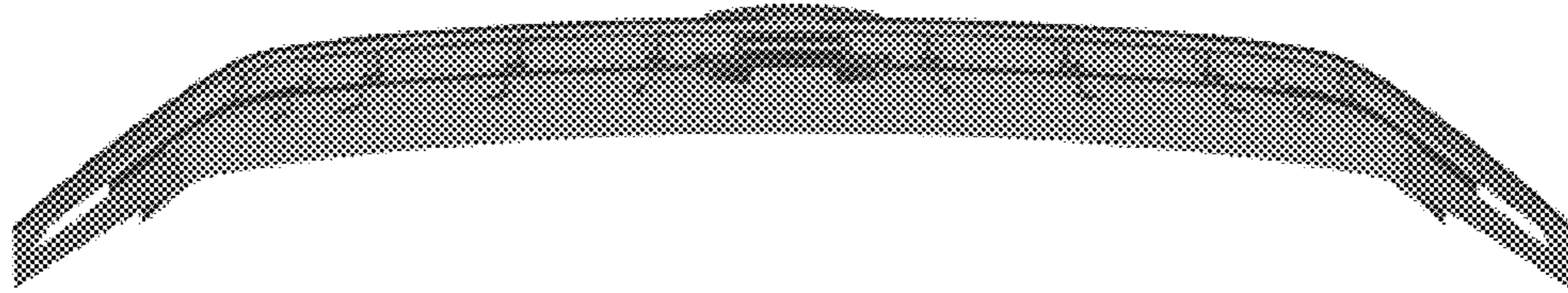

Fig. 7

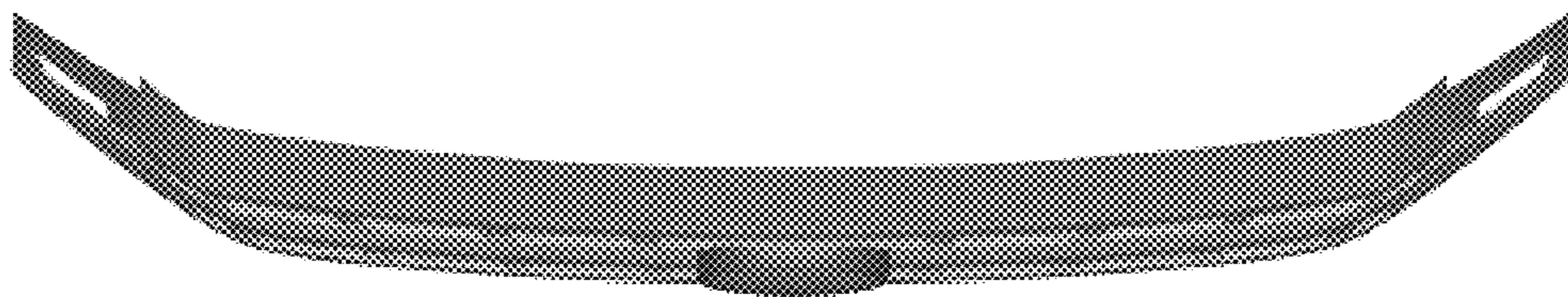

Fig. 8