



US00D971775S

(12) **United States Design Patent**
Yatsugi-Kang

(10) **Patent No.:** **US D971,775 S**

(45) **Date of Patent:** **** Dec. 6, 2022**

(54) **PAIR OF EARRINGS**

(71) Applicant: **Harry Winston SA**, Plan-les-Ouates
(CH)

(72) Inventor: **Rie Yatsugi-Kang**, New York, NY (US)

(73) Assignee: **Harry Winston SA**, Plan-les-Ouates
(CH)

(**) Term: **15 Years**

(21) Appl. No.: **29/783,764**

(22) Filed: **May 14, 2021**

(30) **Foreign Application Priority Data**

Nov. 27, 2020 (WO) WIPO99837

(51) **LOC (13) Cl.** **11-01**

(52) **U.S. Cl.**
USPC **D11/42**

(58) **Field of Classification Search**
USPC ... D11/40-45, 63, 67-69, 75-76, 34, 89, 56
CPC A44C 7/00; A44C 7/001; A44C 7/002;
A44C 7/003; A44C 7/004; A44C 7/005;
A44C 7/006; A44C 7/007; A44C 7/008;
A44C 7/009; A44C 1/00; A44C 17/00;
A44C 17/001; A44C 17/005; A44C
17/007; A44C 17/02; A44C 17/0208

See application file for complete search history.

(56) **References Cited**

U.S. PATENT DOCUMENTS

D729,107 S * 5/2015 Riviere D11/42
D753,012 S * 4/2016 Yatsugi-Kang D11/75
D934,728 S * 11/2021 Wuest D11/42
D938,297 S * 12/2021 Abdourahim D11/42
D938,298 S * 12/2021 Riviere D11/43
D938,300 S * 12/2021 Abdourahim D11/43

D938,301 S * 12/2021 Riviere D11/43
D938,853 S * 12/2021 Abdourahim D11/42
D938,854 S * 12/2021 Kwon D11/42
D939,376 S * 12/2021 Riviere D11/42
D942,306 S * 2/2022 Abdourahim D11/42
D946,455 S * 3/2022 Riviere D11/34
D946,456 S * 3/2022 Kwon D11/34
D955,261 S * 6/2022 Kwon D11/42
D955,262 S * 6/2022 Abdourahim D11/42

(Continued)

FOREIGN PATENT DOCUMENTS

WO D203137-002 * 1/2020 11/1

OTHER PUBLICATIONS

Editorialist—Harry Winston Cluster Earrings, available Feb. 14, 2022, online, site visited Aug. 9, 2022. Available online, URL: <https://editorialist.com/fashion/best-luxury-jewelry/> (Year: 2022).*

(Continued)

Primary Examiner — W. A. Teddy Falloway

Assistant Examiner — Sarah J Ault

(74) *Attorney, Agent, or Firm* — Blank Rome LLP

(57) **CLAIM**

The ornamental design for a pair of earrings, as shown and described.

DESCRIPTION

FIG. 1 is a front view of a pair of earrings of my new design; FIG. 2 is a rear view thereof; FIG. 3 is a right side view thereof; FIG. 4 is a left side view thereof; FIG. 5 is a top rear perspective view thereof; FIG. 6 is a bottom view thereof; FIG. 7 is a front right perspective view thereof; and, FIG. 8 is a rear left perspective view thereof.

1 Claim, 8 Drawing Sheets

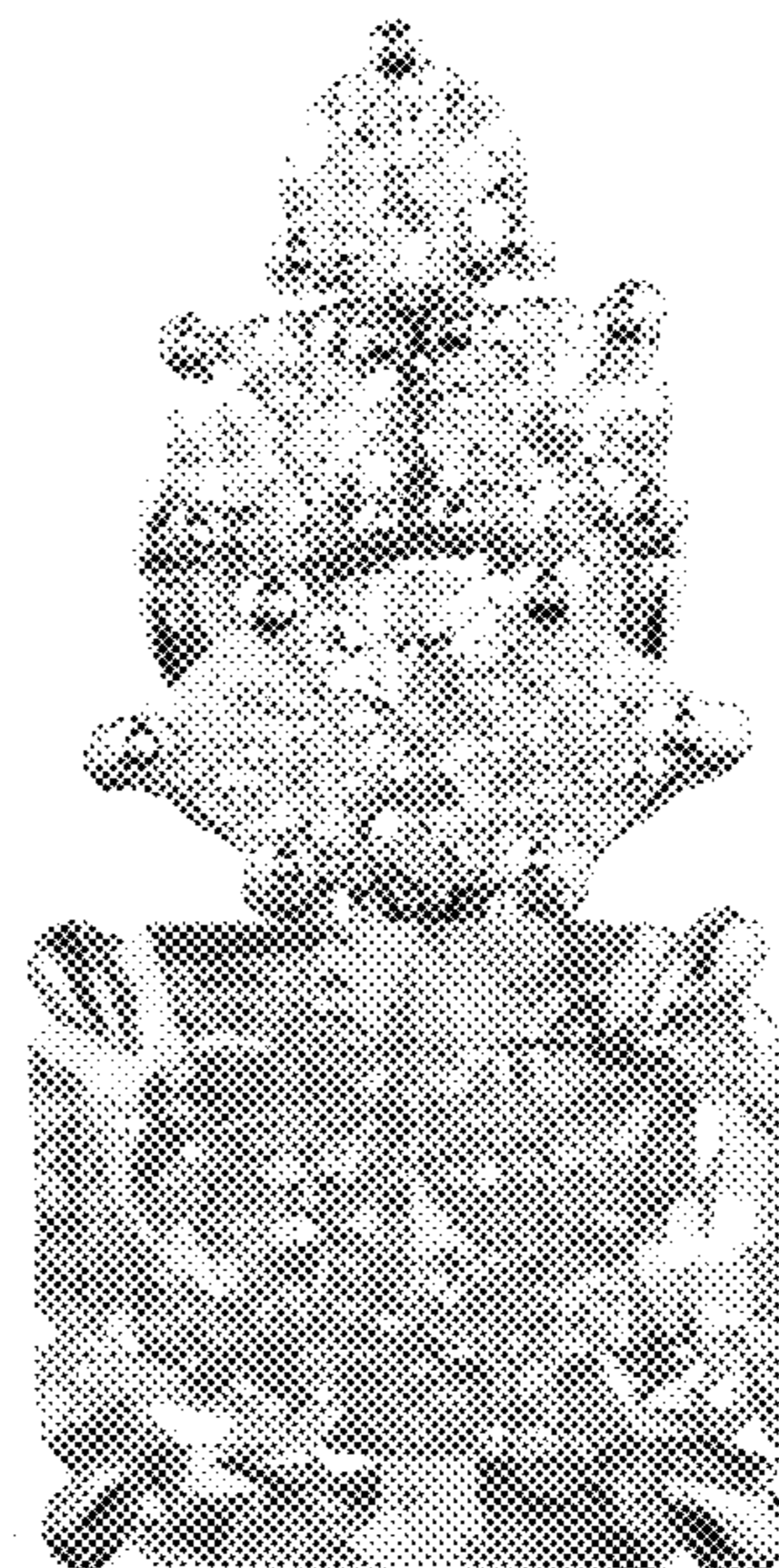
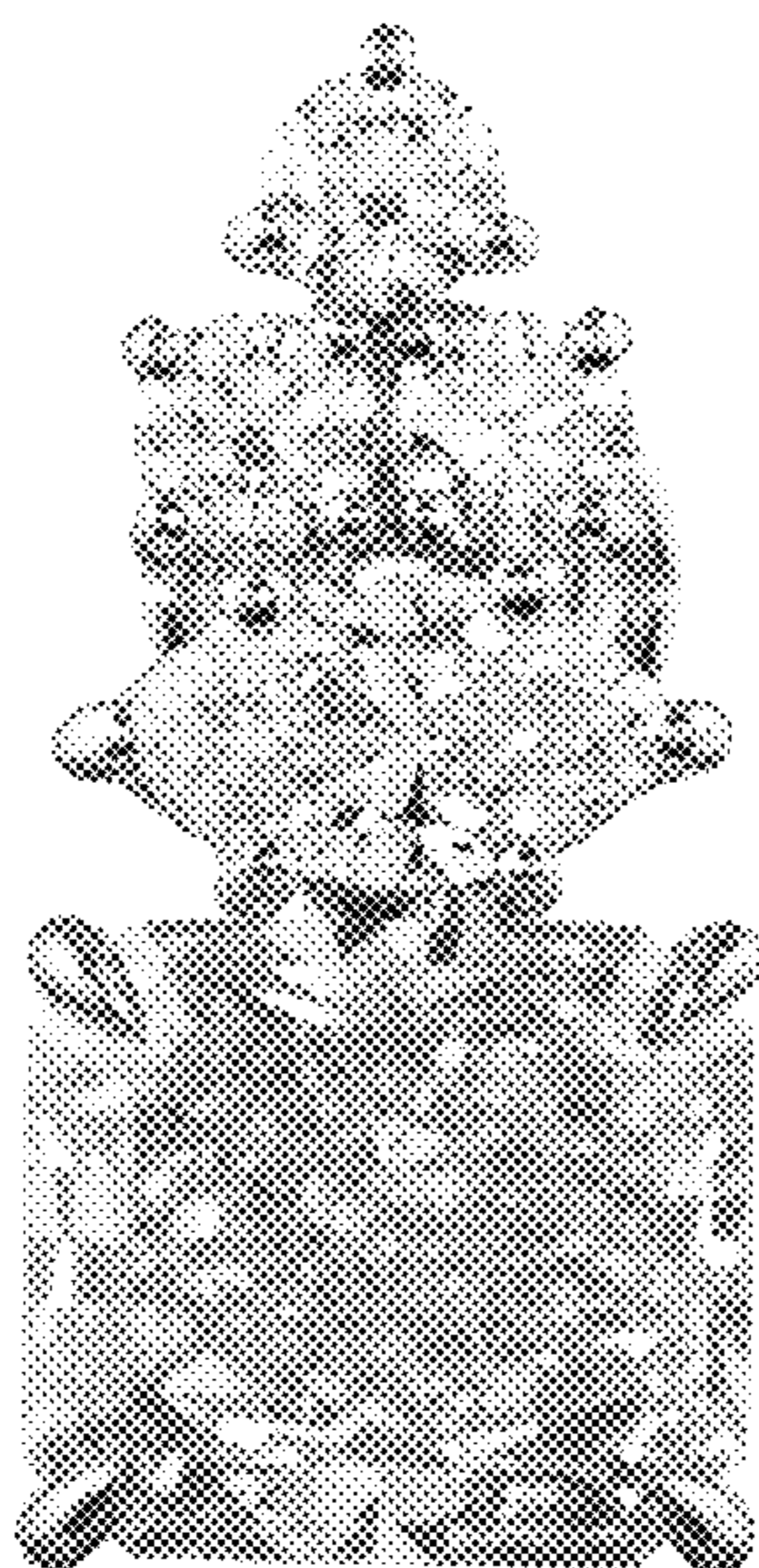

(56)

References Cited

U.S. PATENT DOCUMENTS

D955,266 S * 6/2022 Riviere D11/42

OTHER PUBLICATIONS

Pair of Ruby and Diamond Earrings Harry Winston, available 2022, online, site visited Aug. 9, 2022. Available online, URL: <http://www.sothebys.com/en/auctions/ecatalogue/2018/magnificent-jewels-and-noble-jewels-ge1805/lot.405.html> (Year: 2022).*

* cited by examiner

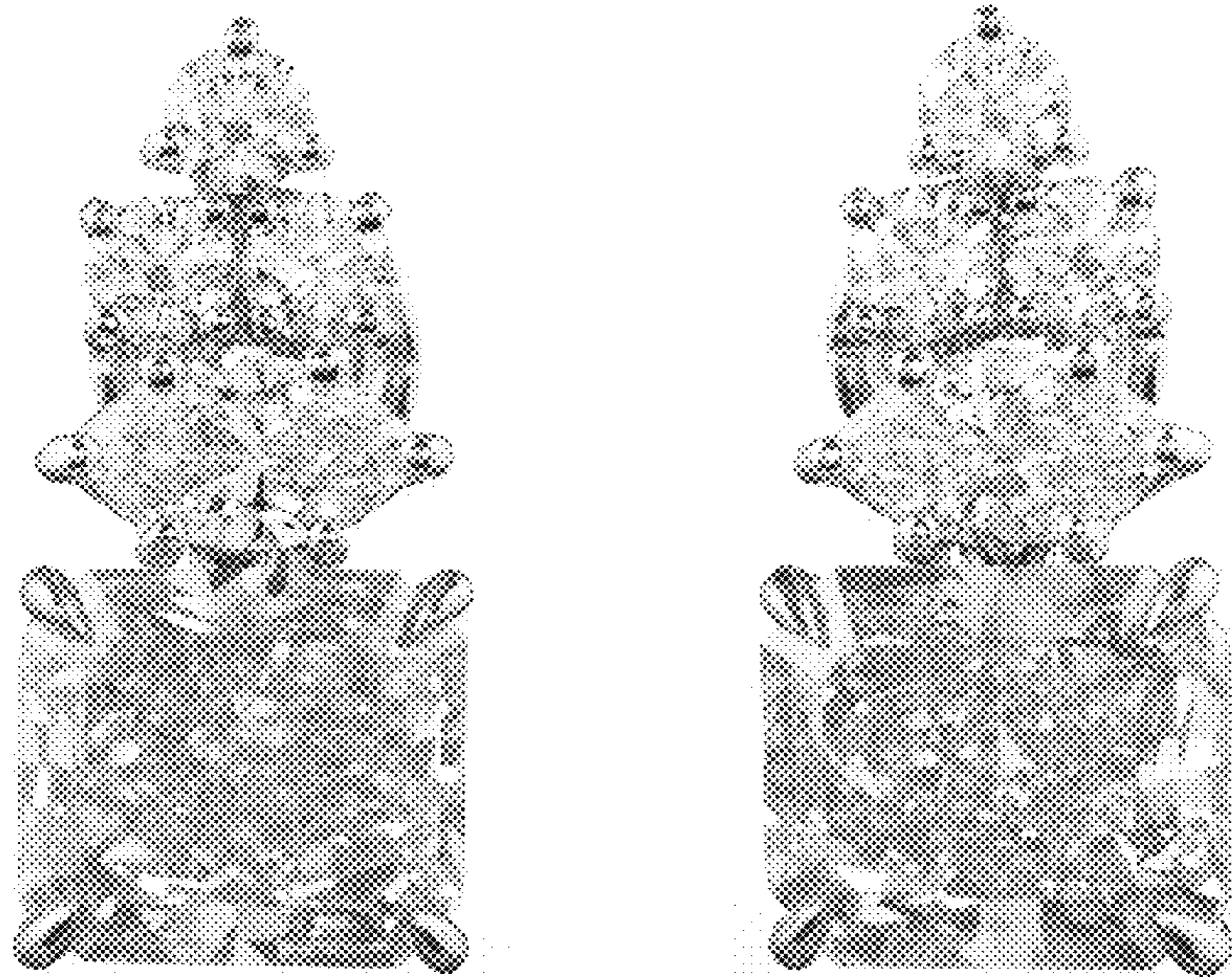

FIG. 1

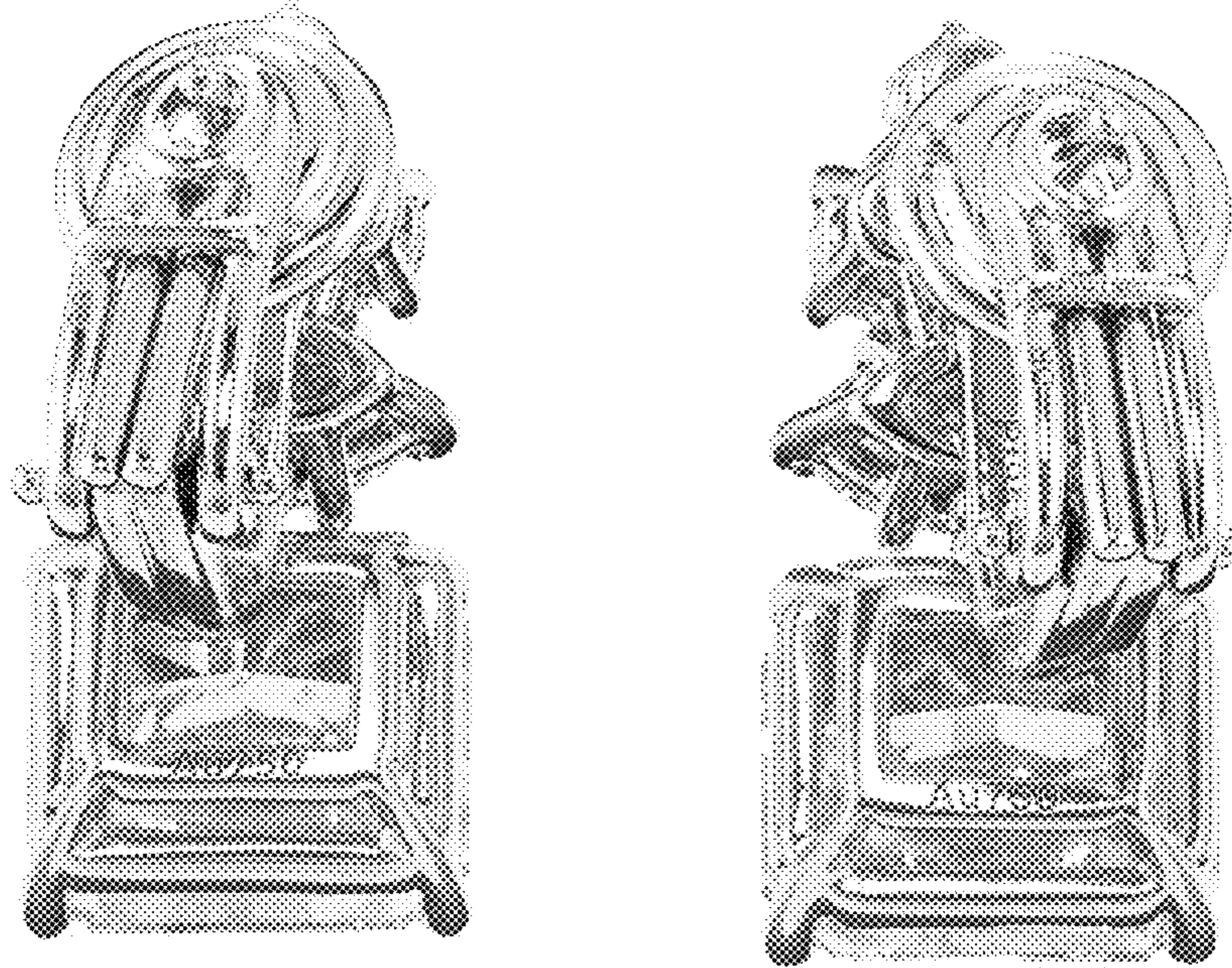

FIG. 2

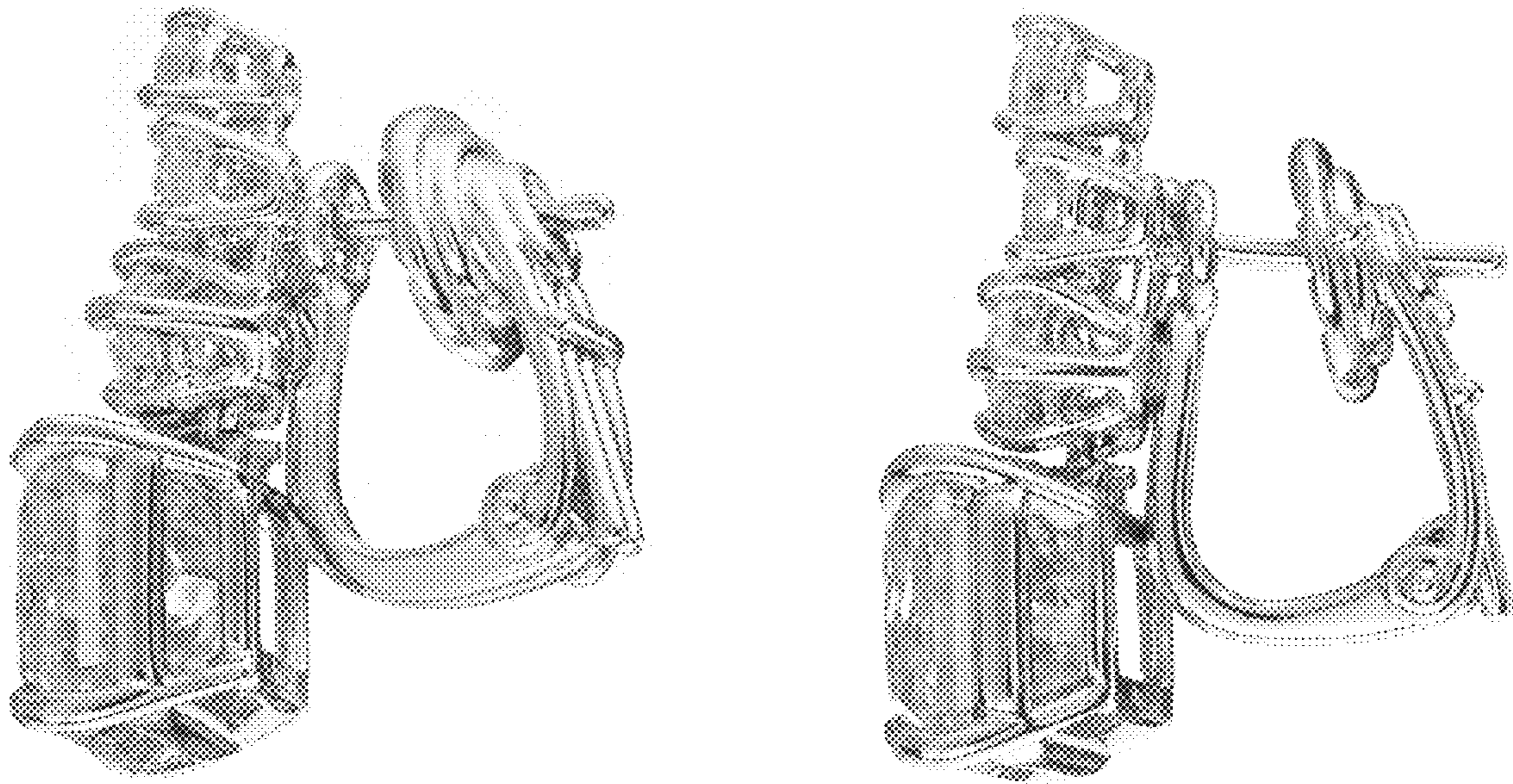

FIG. 3

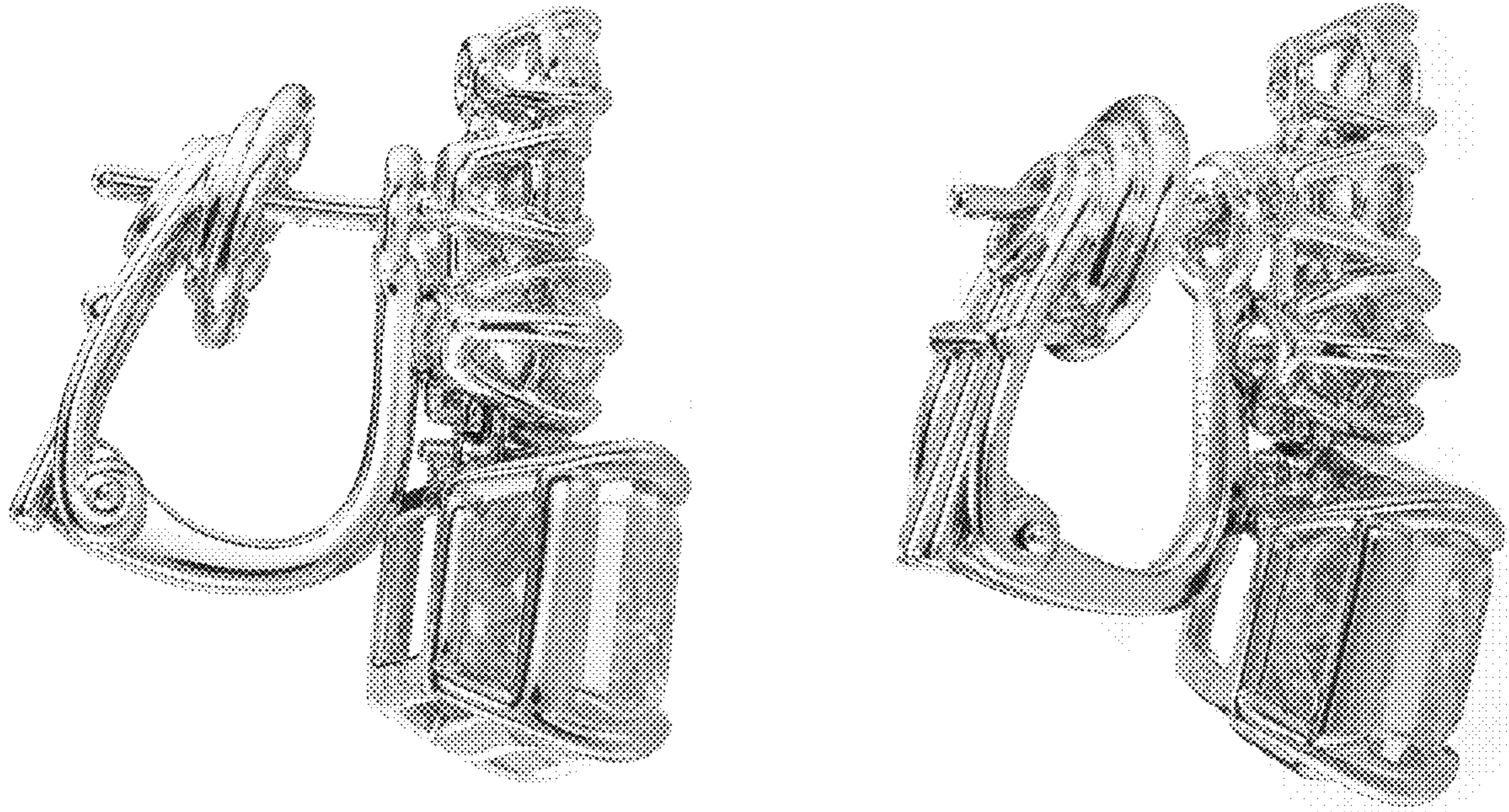

FIG. 4

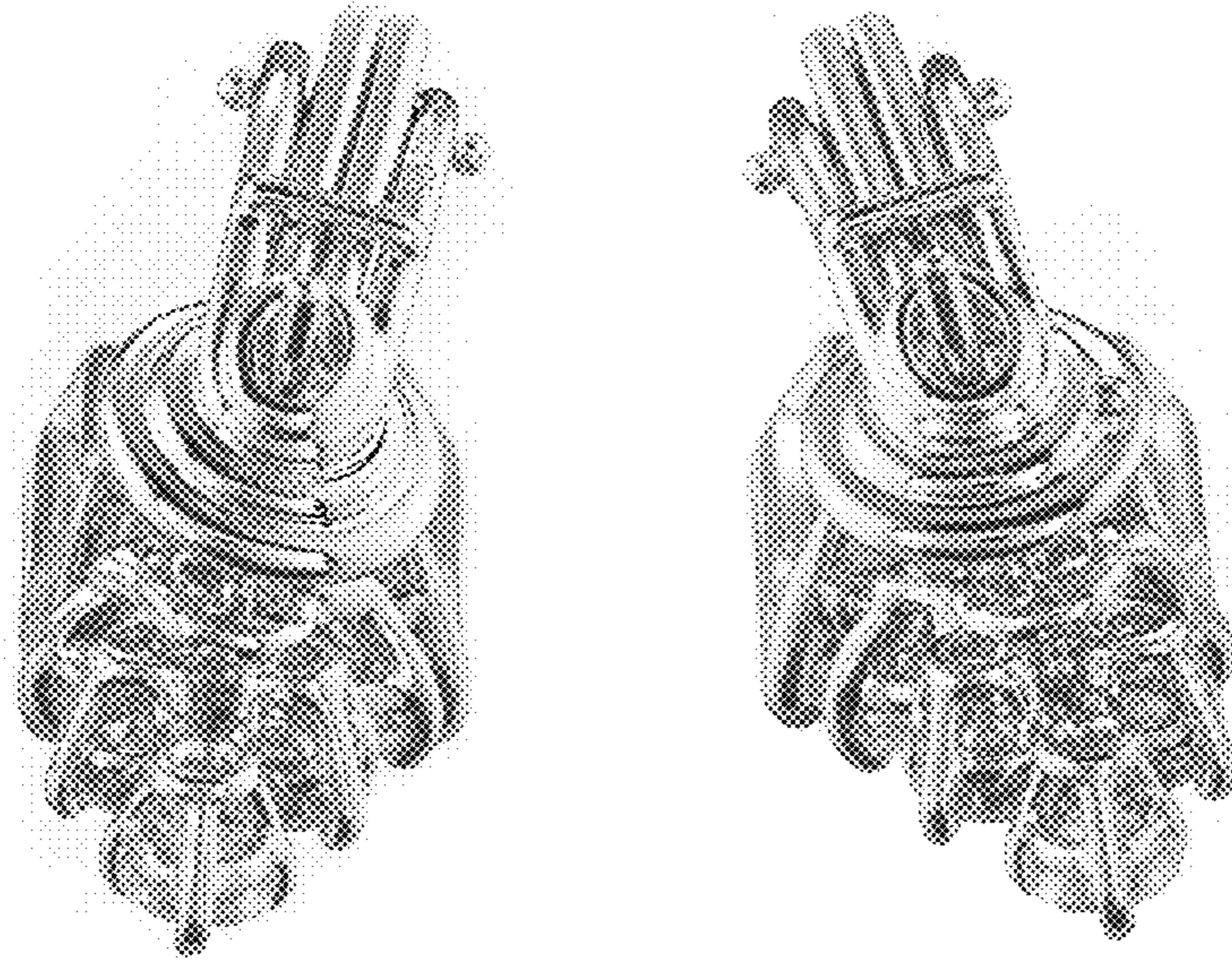

FIG. 5

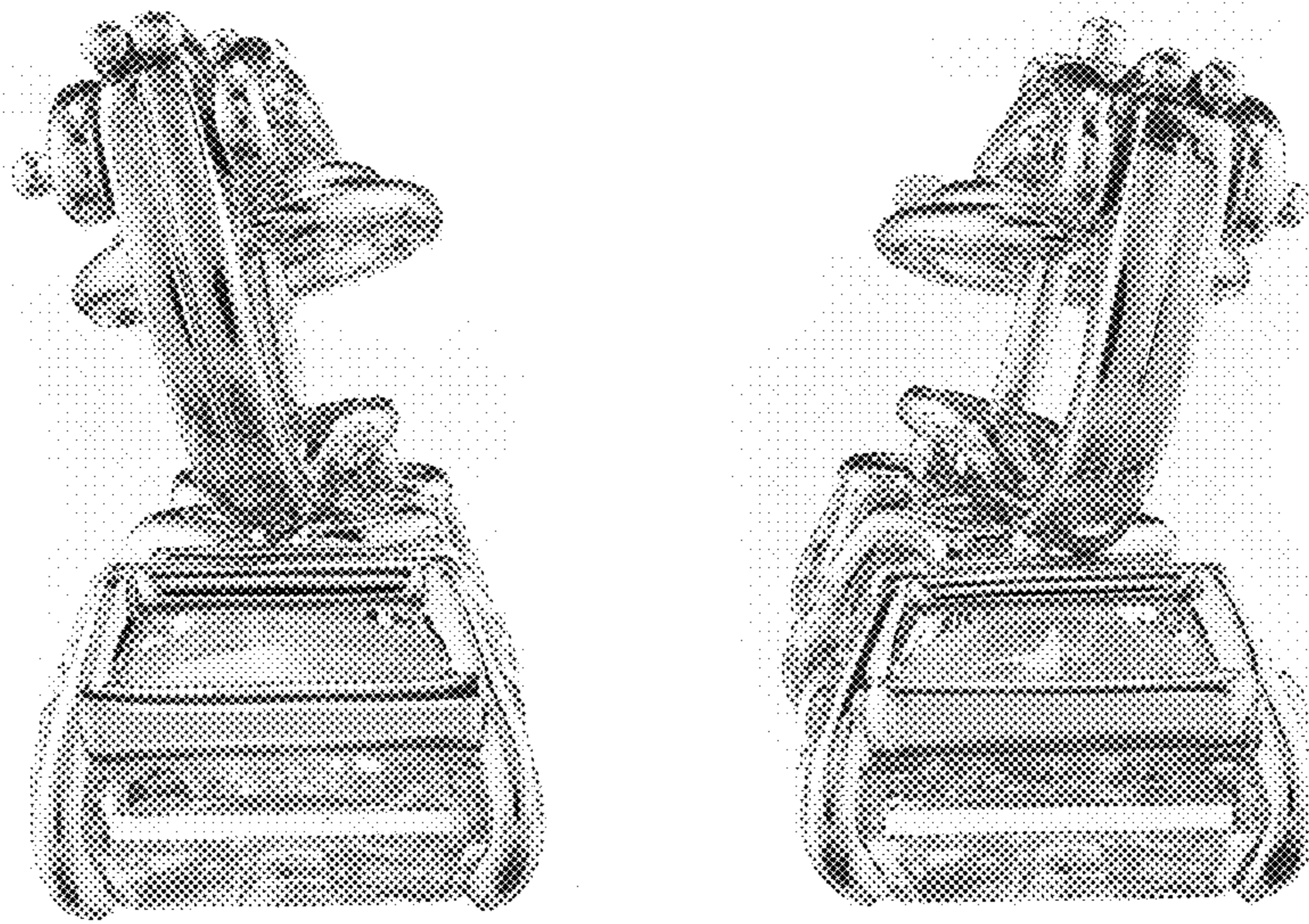

FIG. 6



FIG. 7



FIG. 8