



US00D971744S

(12) **United States Design Patent** (10) **Patent No.:** **US D971,744 S**  
**Yang** (45) **Date of Patent:** **\*\* Dec. 6, 2022**

(54) **PLASTIC BAG**

(71) Applicant: **Universal Trim Supply Co., Ltd.**, New Taipei (TW)

(72) Inventor: **Chih-Wei Yang**, Taipei (TW)

(73) Assignee: **SEALVAX LLC**, Sacramento, CA (US)

(\*\*) Term: **15 Years**

(21) Appl. No.: **29/784,730**

(22) Filed: **May 21, 2021**

**Related U.S. Application Data**

(63) Continuation-in-part of application No. 29/735,554, filed on May 21, 2020, now Pat. No. Des. 965,438.

(51) **LOC (13) Cl.** ..... **09-05**

(52) **U.S. Cl.**  
USPC ..... **D9/709**

(58) **Field of Classification Search**

USPC ..... D9/456, 499, 427, 730, 732, 736, 737, D9/748, 749, 755, 759, 760, 761, D9/433-436, 702, 703, 707, 709, 710; D7/311, 396.1, 396.4, 550.1, 553.2, D7/553.3, 554.3, 555, 601, 602, 620, 704; D23/260, 261; D5/1-3, 46, 47, 54; D3/201, 272, 304

CPC ..... B65D 75/52; B65D 31/02; B65D 31/147; B65D 33/25; B65D 33/2584; B65D 75/008; B65D 81/2023

See application file for complete search history.

(56) **References Cited**

**U.S. PATENT DOCUMENTS**

D13,041 S 7/1882 Burgess  
D116,386 S 8/1939 Sigoda  
D131,584 S 3/1942 Roberson  
D189,544 S 1/1961 Harris  
3,067,039 A 12/1962 Crane

(Continued)

**OTHER PUBLICATIONS**

Yanko Design. This Smartphone Powered Vacuum Sealer and Food Bag Lets You Keep Food Fresher for Longer! Feb. 10, 2021. <https://www.yankodesign.com/2021/02/10/this-smartphone-powered-vacuum-sealer-and-food-bag-lets-you-keep-food-fresher-for-longer/> (Year: 2021).\*

(Continued)

*Primary Examiner* — Darcey E Gottschalk

(74) *Attorney, Agent, or Firm* — Winston Hsu

(57) **CLAIM**

The ornamental design for a plastic bag, as shown and described.

**DESCRIPTION**

FIG. 1 is a top, front, right side perspective view of a first embodiment of a plastic bag, showing my new design; FIG. 2 is a front elevation view thereof; FIG. 3 is a rear elevation view thereof; FIG. 4 is a left side elevation view thereof; FIG. 5 is a right side elevation view thereof; FIG. 6 is a top plan view thereof; FIG. 7 is a bottom plan view thereof; FIG. 8 is a top, front, right side perspective view of a second embodiment of the plastic bag, showing my new design; FIG. 9 is a front elevation view thereof; FIG. 10 is a rear elevation view thereof; FIG. 11 is a left side elevation view thereof; FIG. 12 is a right side elevation view thereof; FIG. 13 is a top plan view thereof; and, FIG. 14 is a bottom plan view thereof.

The broken lines showing the plastic bag in the drawings depict environmental subject matter that forms no part of the claimed design.

**1 Claim, 14 Drawing Sheets**

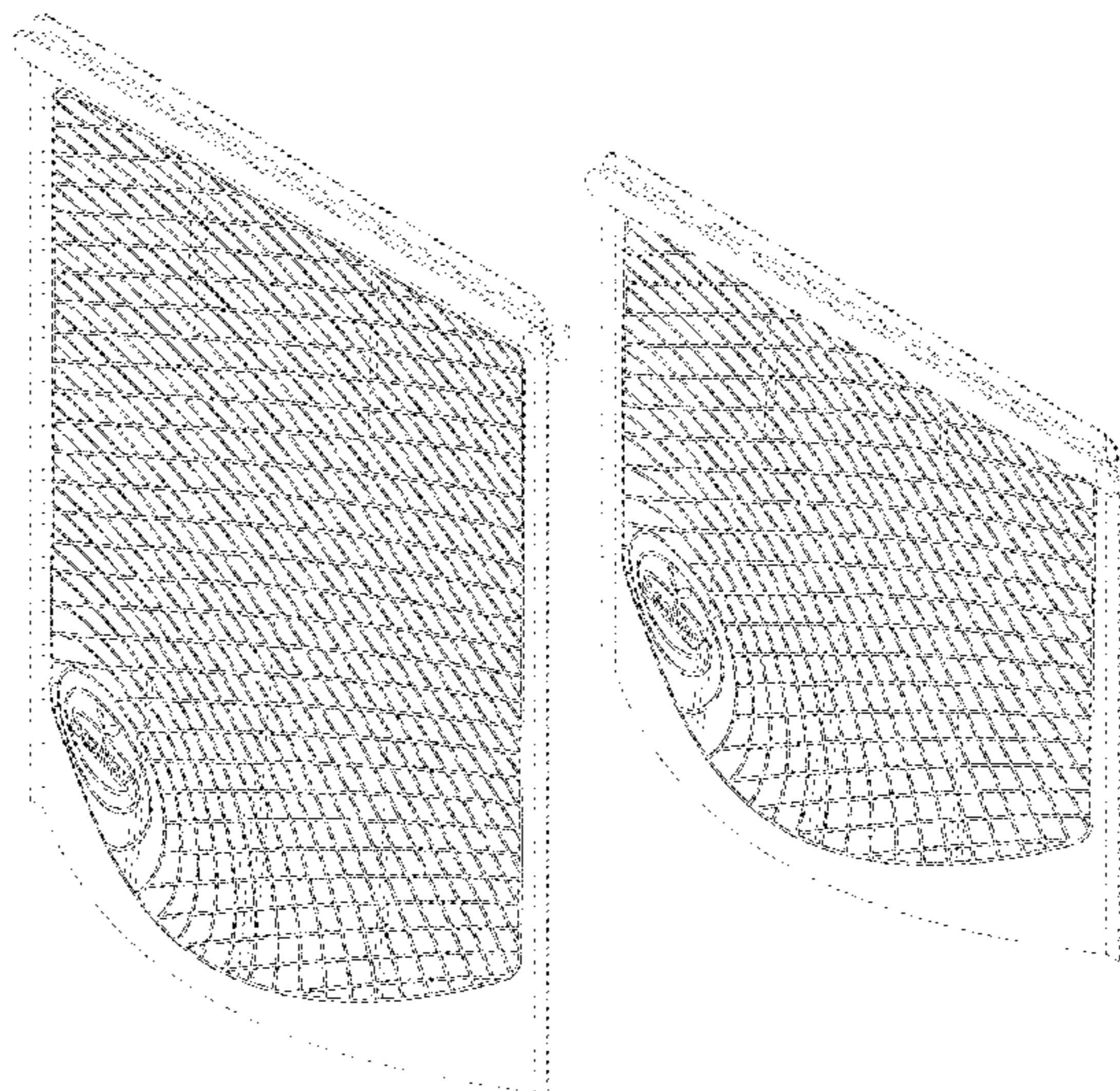

(56)

**References Cited**

## U.S. PATENT DOCUMENTS

3,123,279	A	3/1964	Day
3,184,149	A	5/1965	Repko
3,349,990	A	10/1967	Woodford
D215,588	S	10/1969	Hooton
D228,283	S	9/1973	Reifers
D331,364	S	12/1992	Barker
5,937,617	A	8/1999	Yeager
D456,217	S	4/2002	Hawkins
D504,322	S	4/2005	Sanfilippo
D513,192	S	12/2005	Lin
D630,950	S	1/2011	Amidon
D644,120	S	8/2011	Kight
D645,346	S	9/2011	Liebowitz
D694,647	S	12/2013	Hermes
D779,972	S	2/2017	Yu
D795,703	S	8/2017	Contessa
D873,675	S	1/2020	Yu
D876,239	S	2/2020	Yu
11,267,629	B2	3/2022	Yang
2016/0244247	A1	8/2016	Doherty

## OTHER PUBLICATIONS

Amazon. SealVax Handheld Vacuum Sealer Bags for Food, 9-Packs BPA Free Leakproof Reusable Food Storage Bags for Sous Vide Cooking, Fruits, Meal Prep, Sandwich, Snack, Veggies Fresh, Freezers & Marinate Food. Apr. 9, 2021. <https://www.amazon.com/SealVax-Family-Reusable-portable-Dishwasher-Safe/dp/B0924CLRGG> (Year: 2021).\*

Youtube. "SealVax: Portable Vacuum Sealer Powered by Smartphone". by Healthy Recipe Channel. Jan. 18, 2021. <https://www.youtube.com/watch?v=DZhU8qkipN4> (Year: 2021).\*

Yang, the specification, including the claims, and drawings in the U.S. Appl. No. 29/735,554, filed May 21, 2020.

Henry Schein, Inc., "Patient Giveaway Bags", retrieved on May 23, 2022 from the Internet URL: <https://www.henryschein.com/us-en/dental/c/practice-marketing/patient-giveaway-bags>, 2022.

Komol Plastics, "Poly Woven Bags", retrieved on May 23, 2022 from the Internet URL: <https://www.komolplastics.com/poly-woven-bags/>, 2022.

IQS Directory, "Poly Bags", retrieved on May 23, 2022 from the Internet URL: <https://www.iqsdirectory.com/articles/plastic-bag-poly-bags.html>, 2022.

"24"x40" Woven Polypropylene Sandbags—White (100 Bags)—AB-30-2-156", available at Amazon.com from Jul. 25, 2015, Amazon.com, retrieved on May 23, 2022 from the Internet URL: <https://www.amazon.com/24-Woven-Polypropylene-Sandbags-AB-30-2-156/dp/B01LZVO700>, Jul. 25, 2015.

Sheth, "This Smartphone Powered Vacuum Sealer and Food Bag Lets You Keep Food Fresher for Longer!", posted on Feb. 10, 2021, retrieved on May 24, 2022 from the Internet URL: <https://www.yankodesign.com/2021/02/10/this-smartphone-powered-vacuum-sealer-and-food-bag-lets-you-keep-food-fresher-for-longer/>, Feb. 10, 2021.

"SealVax Handheld Vacuum Sealer Bags for Food, 9-Packs BPA Free Leakproof Reusable Food Storage Bags for Sous Vide Cooking, Fruits, Meal Prep, Sandwich, Snack, Veggies Fresh, Freezer & Marinate Food.", available at Amazon.com from Apr. 9, 2021, Amazon.com, retrieved on May 24, 2022 from the Internet URL: <https://www.amazon.com/SealVax-Family-Reusable-portable-Dishwasher-Safe/dp/B0924CLRGG>, Apr. 9, 2021.

"SealVax: Portable Vacuum Sealer Powered by Smartphone", published on Jan. 18, 2021, Healthy Recipe Channel on YouTube, retrieved from the Internet URL: <https://www.youtube.com/watch?v=DZhU8qkipN4>.

"Sealvax product Instruction", published on Dec. 31, 2020, UTS\_TAIWAN on YouTube, retrieved from the Internet URL: <https://www.youtube.com/watch?v=n8AVE3Sy8UE>.

"Portable Vacuum Sealing System 1( Instruction)", Daniel Yang on Vimeo, Oct. 27, 2020, (<https://vimeo.com/472520912>).

Sarang Sheth, "This Smartphone Powered Vacuum Sealer and Food Bag Lets You Keep Food Fresher for Longer!", Yanko Design, Feb. 10, 2021, (<https://www.yankodesign.com/2021/02/10/this-smartphone-powered-vacuum-sealer-and-food-bag-lets-you-keep-food-fresher-for-longer/>).

"SealVax Handheld Vacuum Sealer Bags for Food, 9-Packs BPA Free Leakproof Reusable Food Storage Bags for Sous Vide Cooking, Fruits, Meal Prep, Sandwich, Snack, Veggies Fresh, Freezer & Marinate Food.", Amazon.com, Apr. 9, 2021, (<https://www.amazon.com/SealVax-Family-Reusable-portable-Dishwasher-Safe/dp/B0924CLRGG>).

"SealVax: Portable Vacuum Sealer Powered by Smartphone", Healthy Recipe Channel on YouTube, Jan. 19, 2021, (<https://www.youtube.com/watch?v=DZhU8qkipN4>).

\* cited by examiner

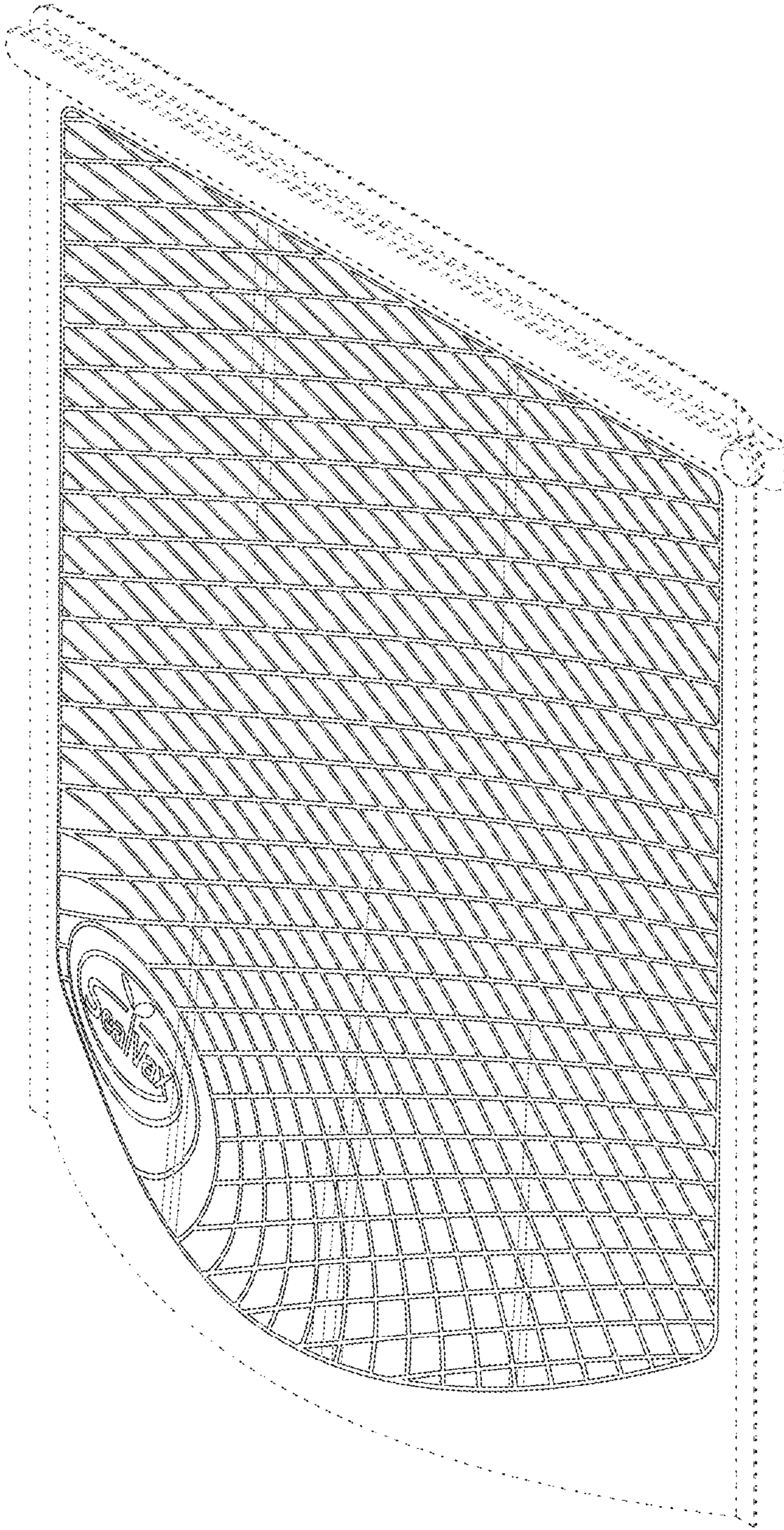

FIG. 1

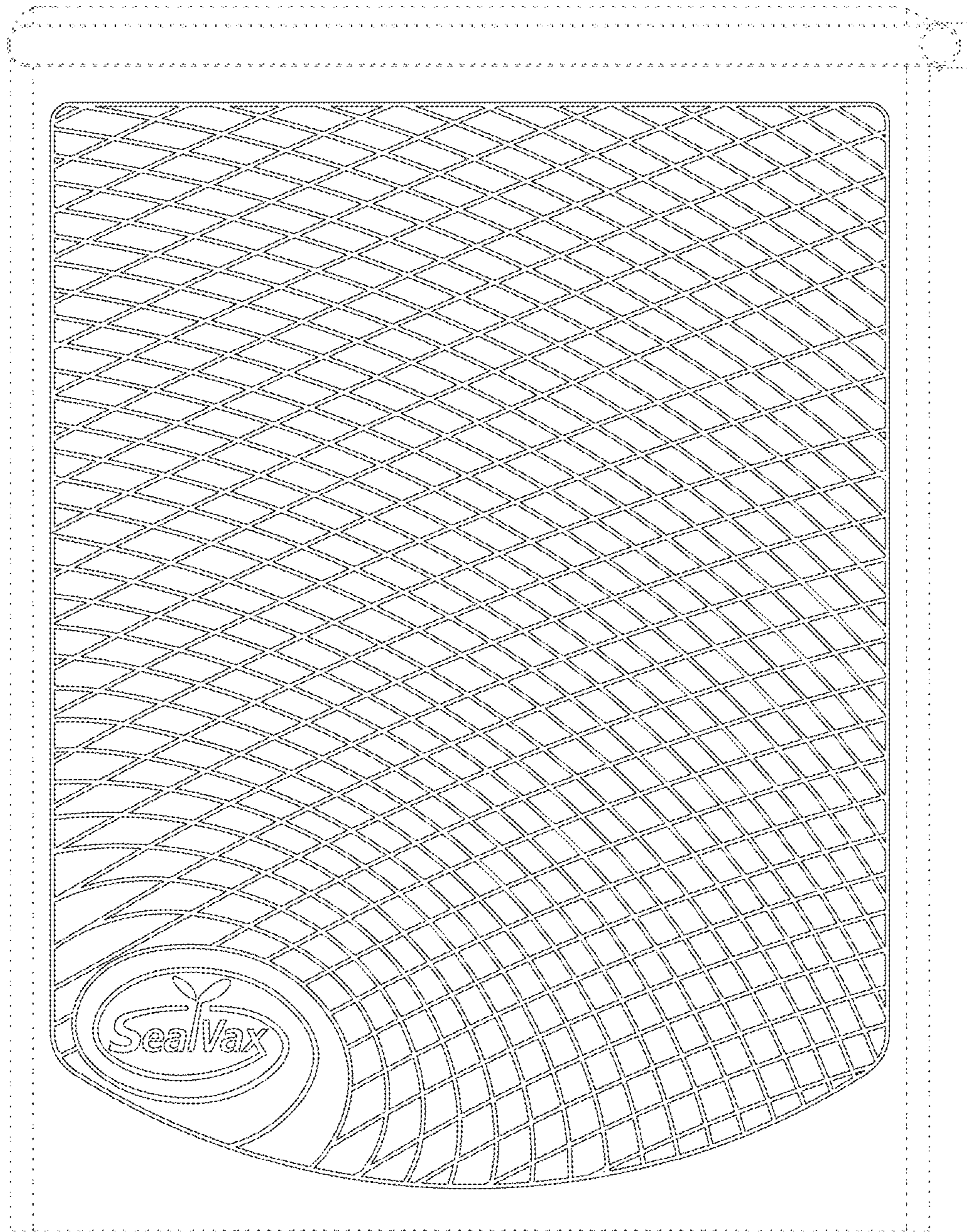

FIG. 2

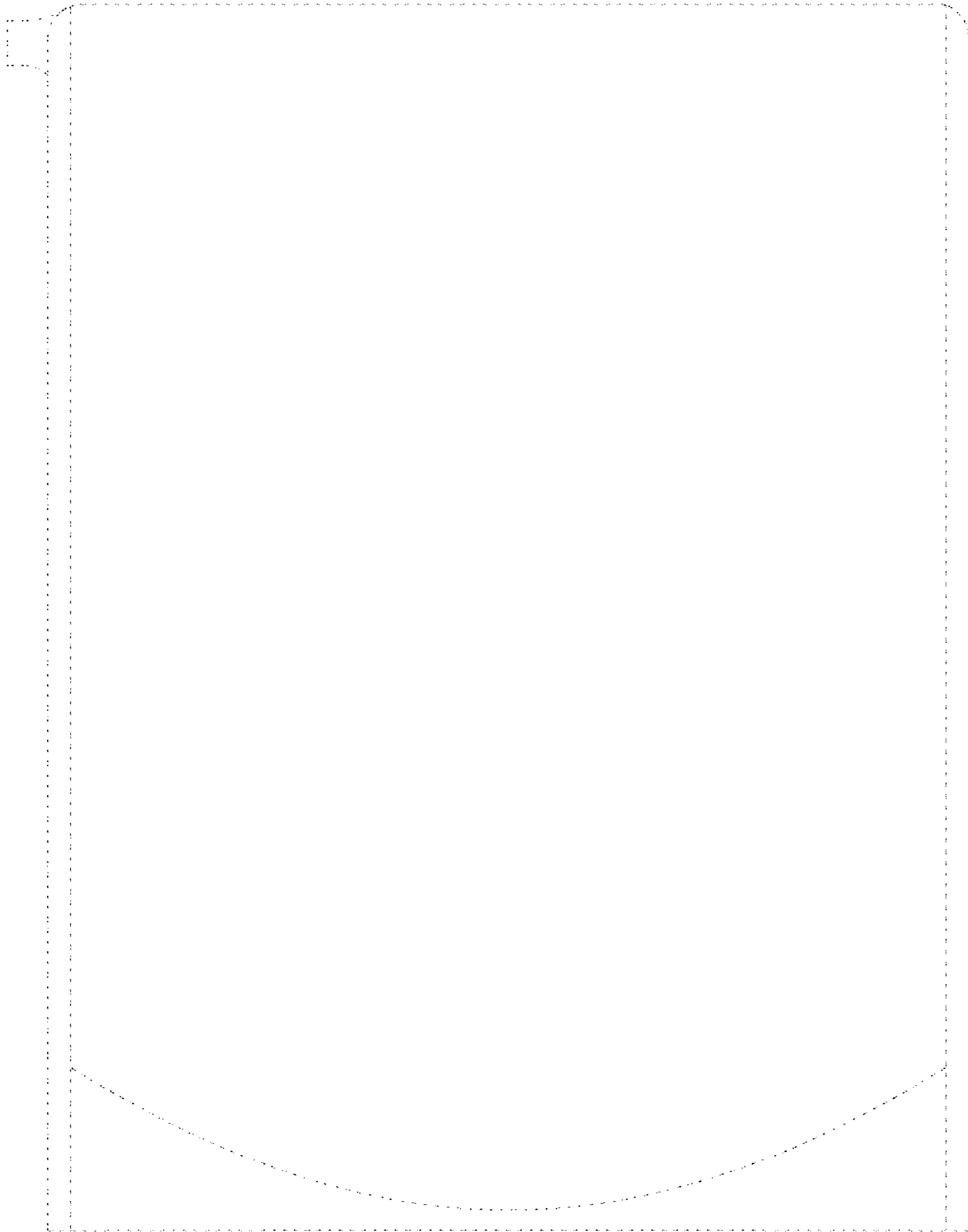

FIG. 3

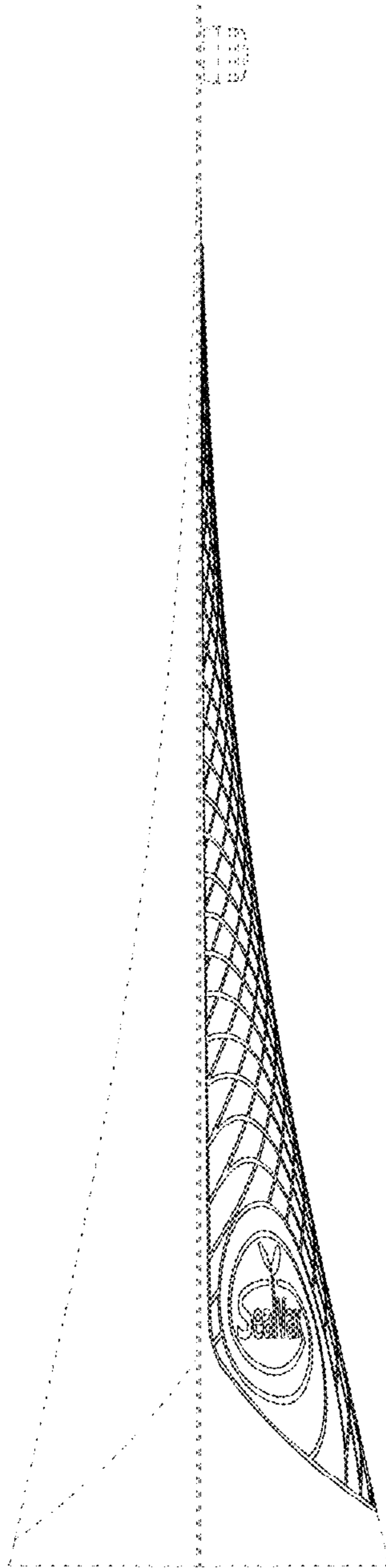

FIG. 4

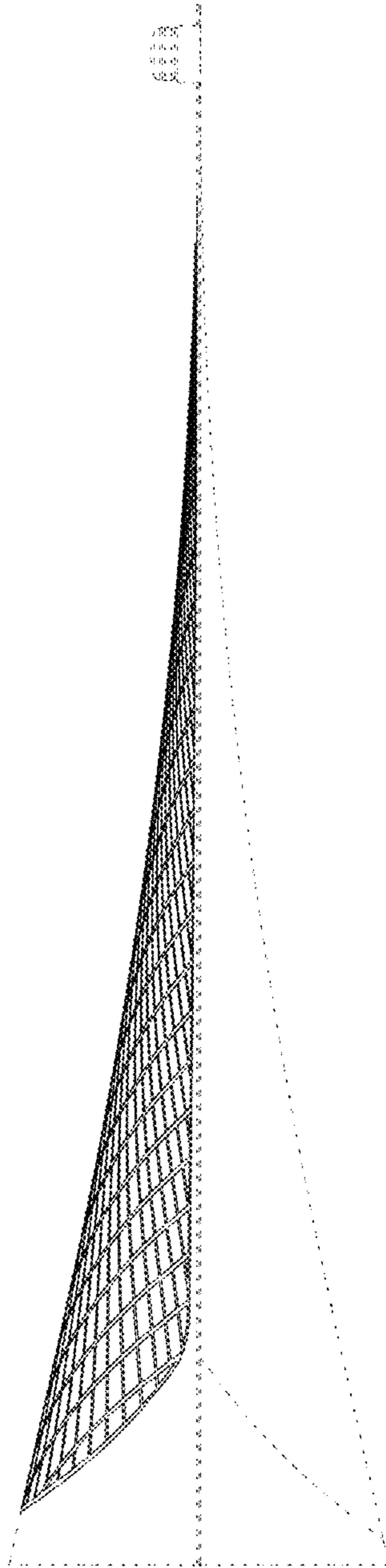

FIG. 5

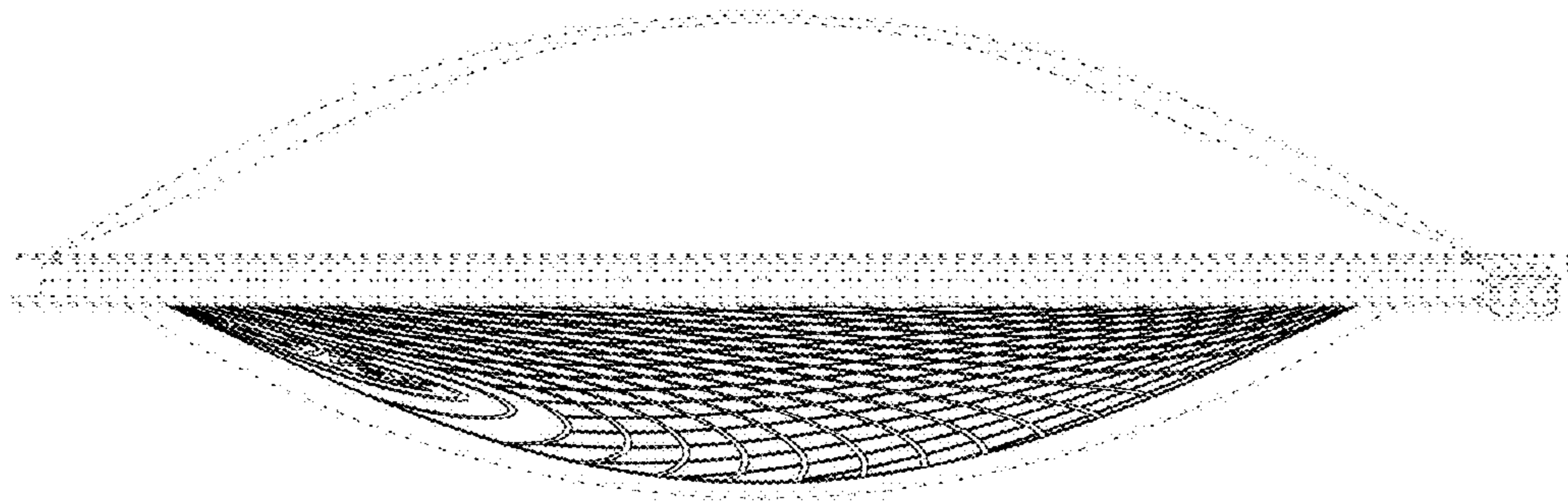

FIG. 6



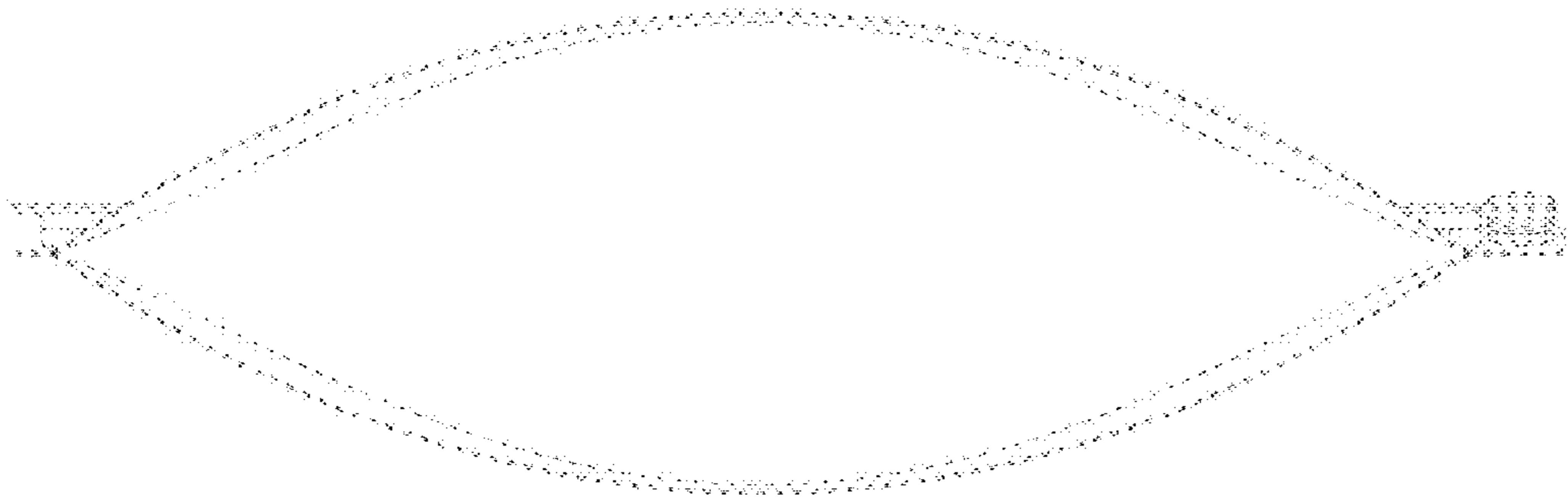

FIG. 7

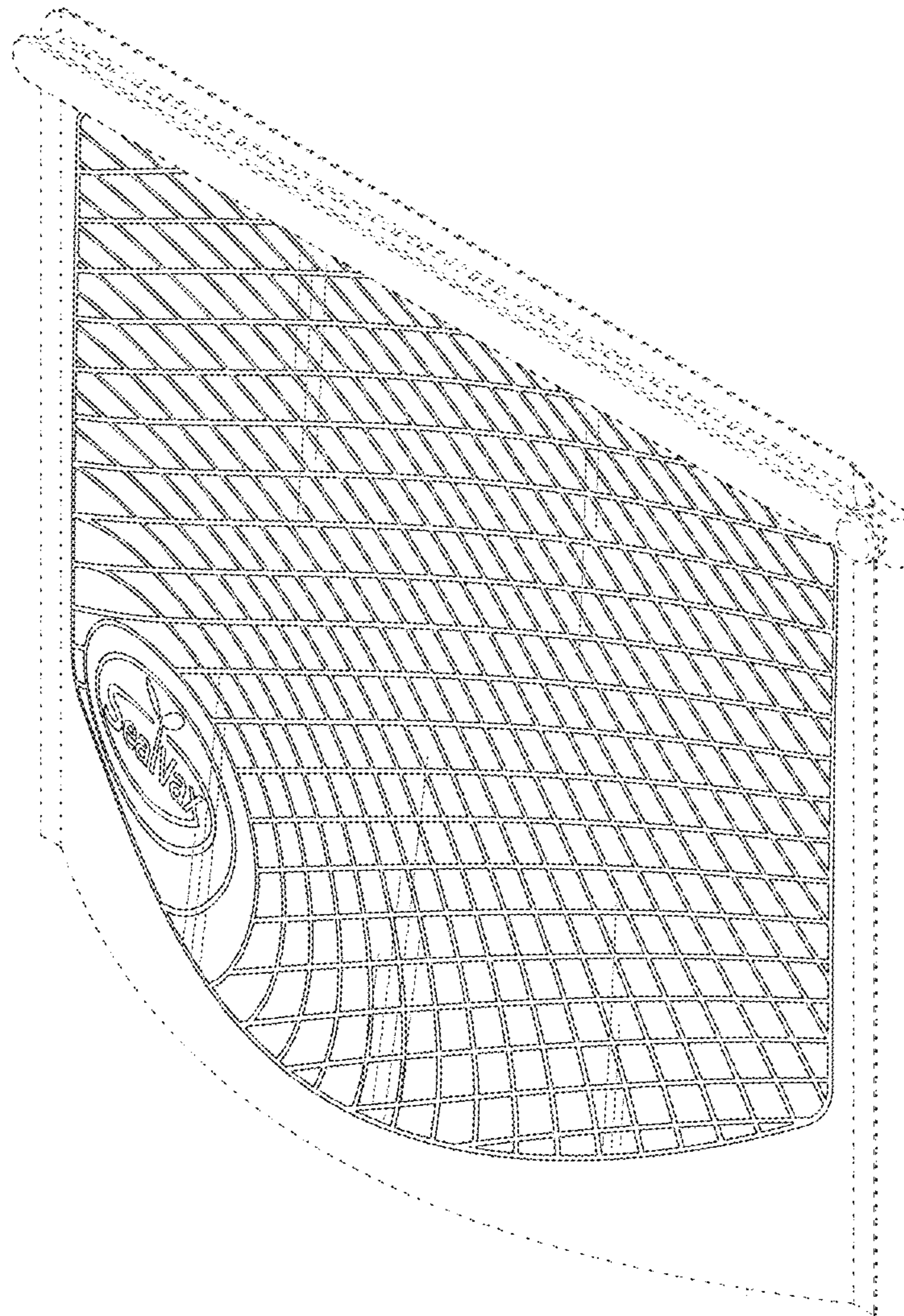

FIG. 8

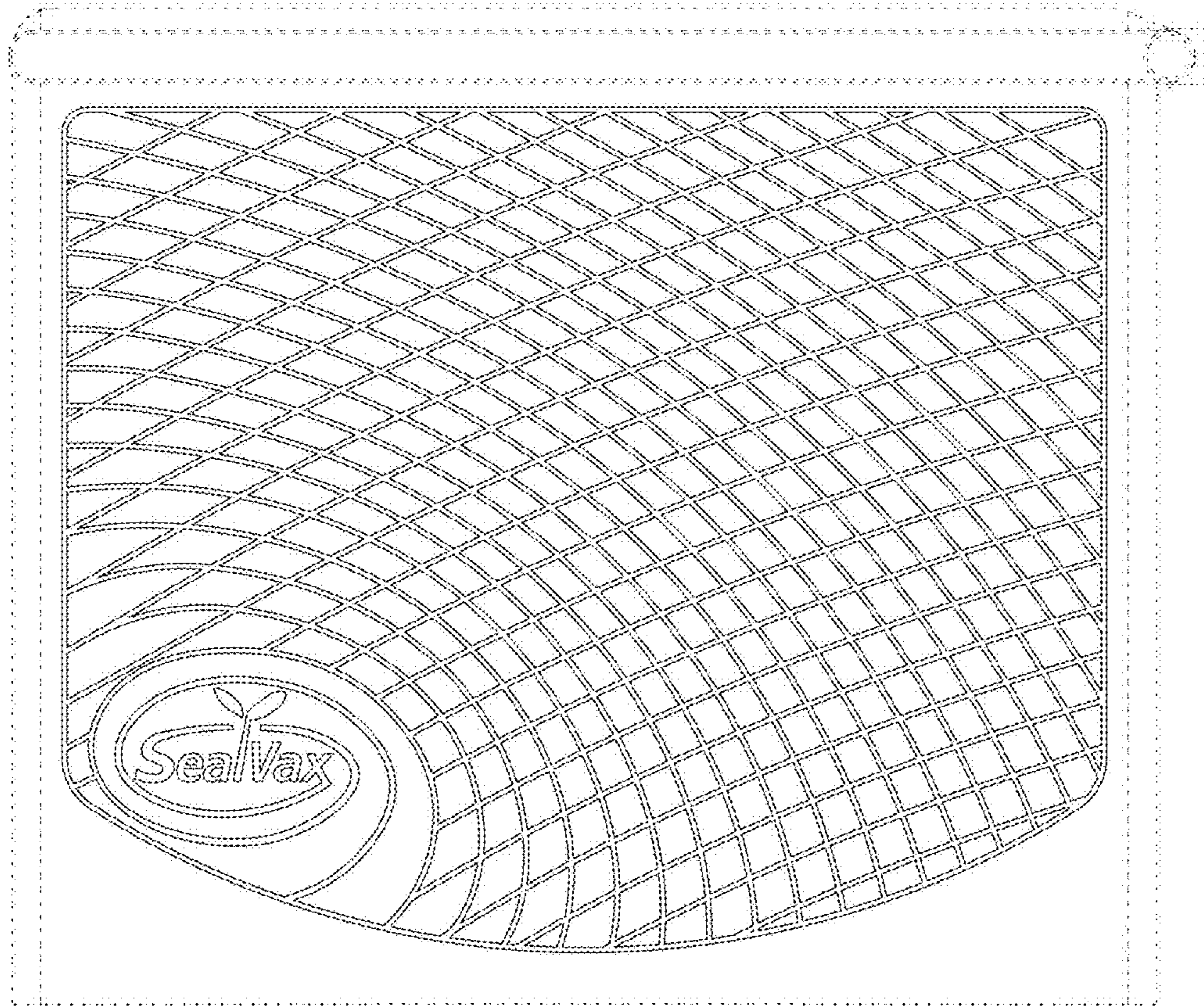

FIG. 9

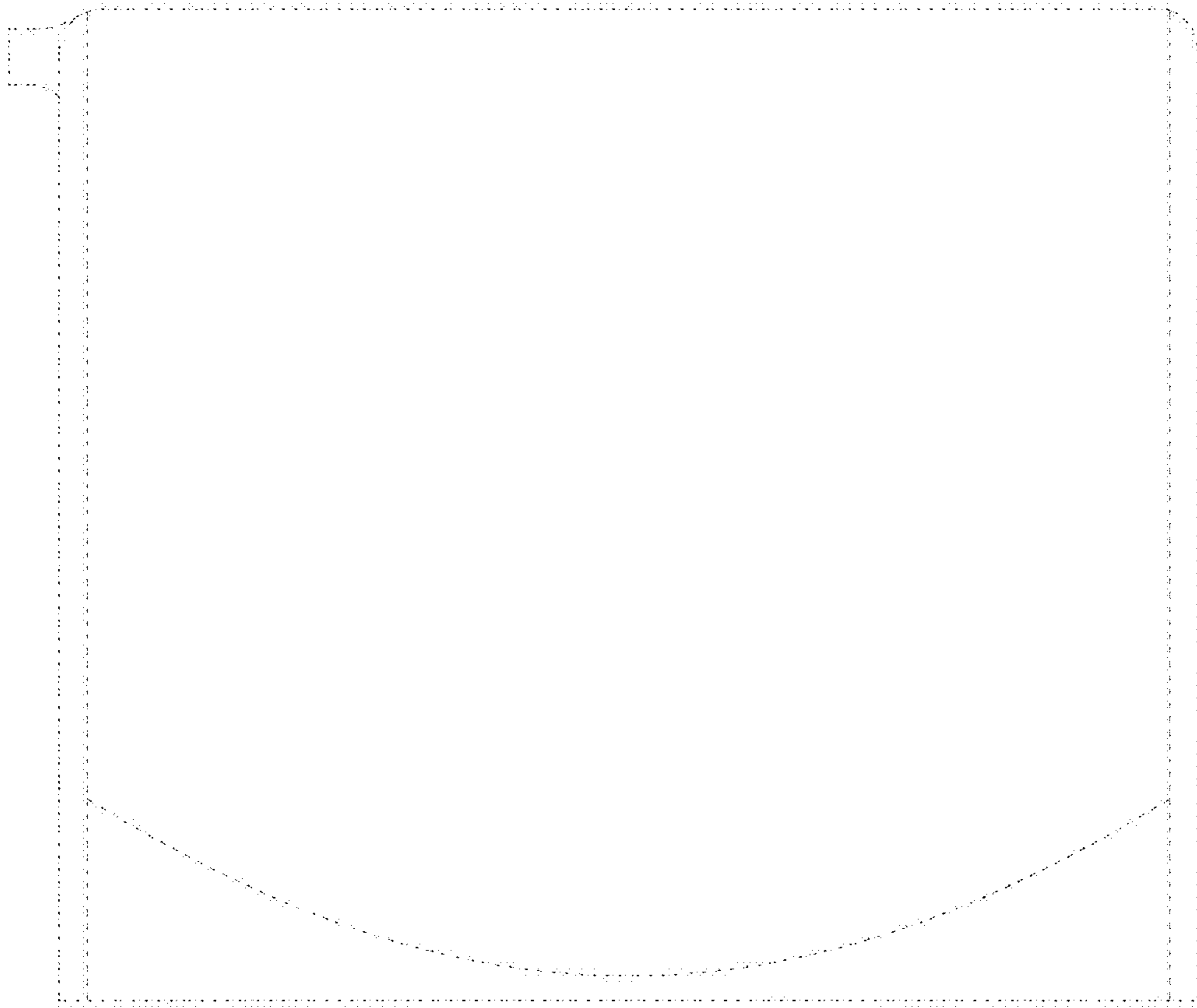

FIG. 10

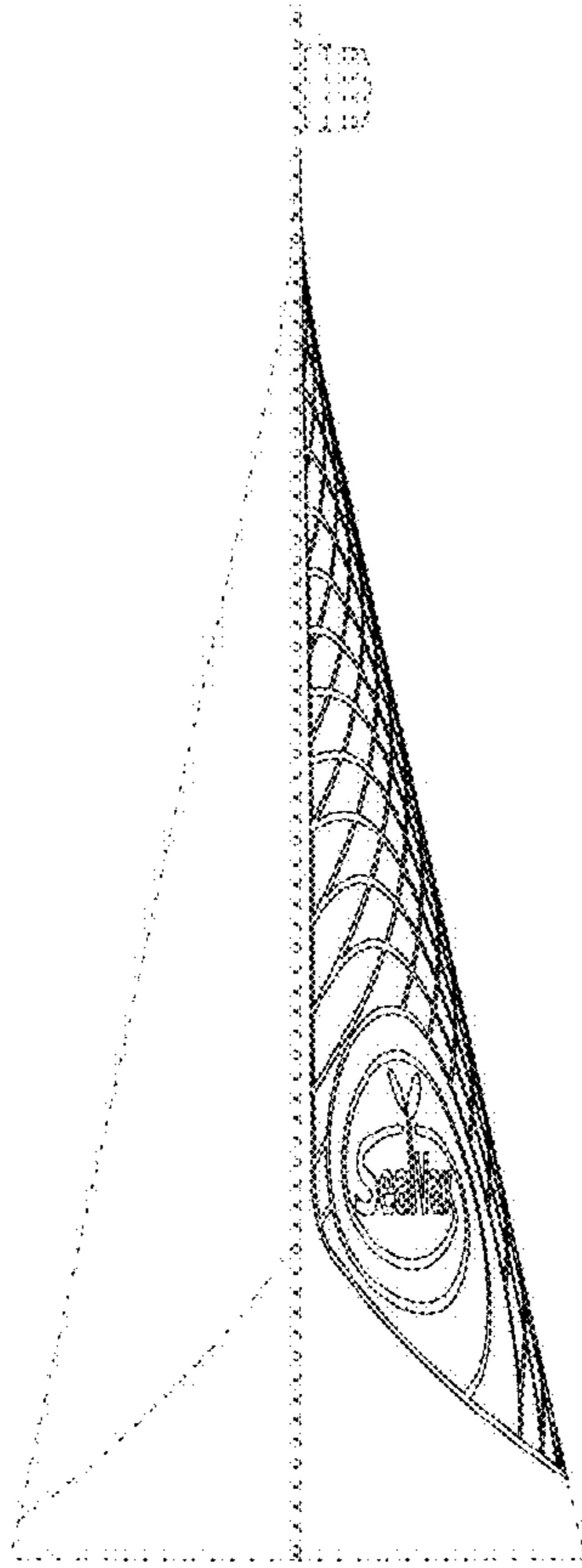

FIG. 11

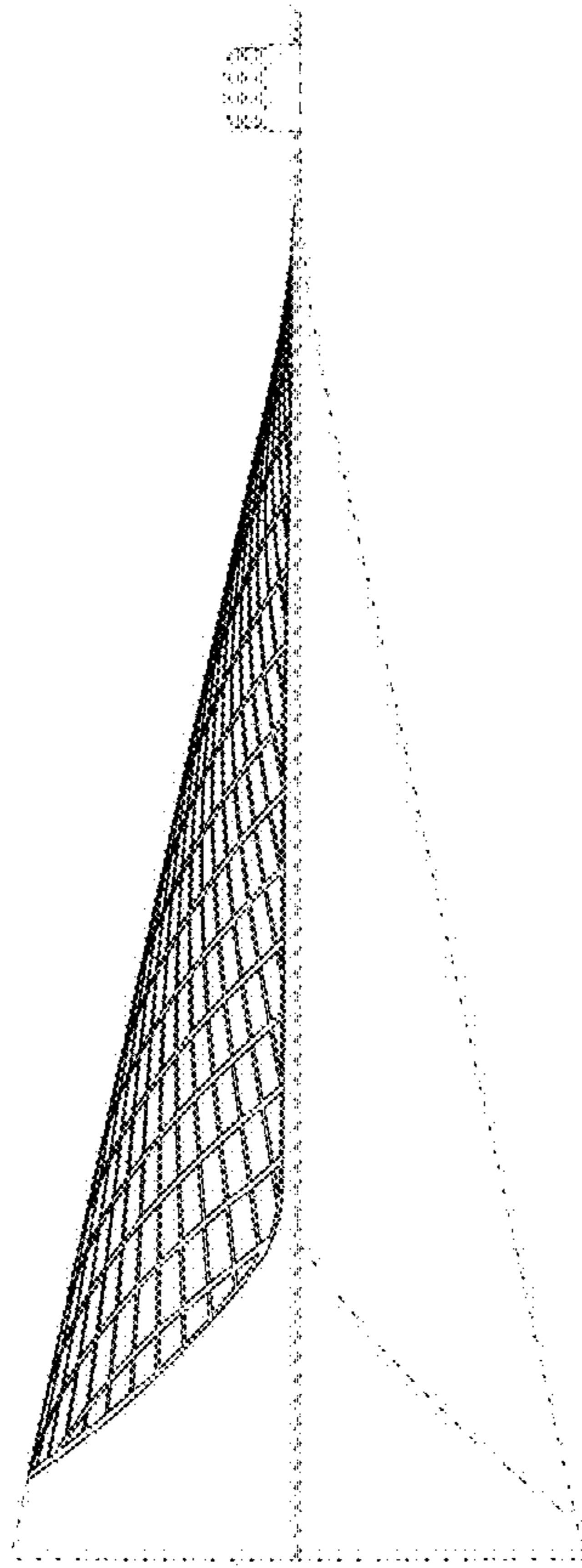

FIG. 12

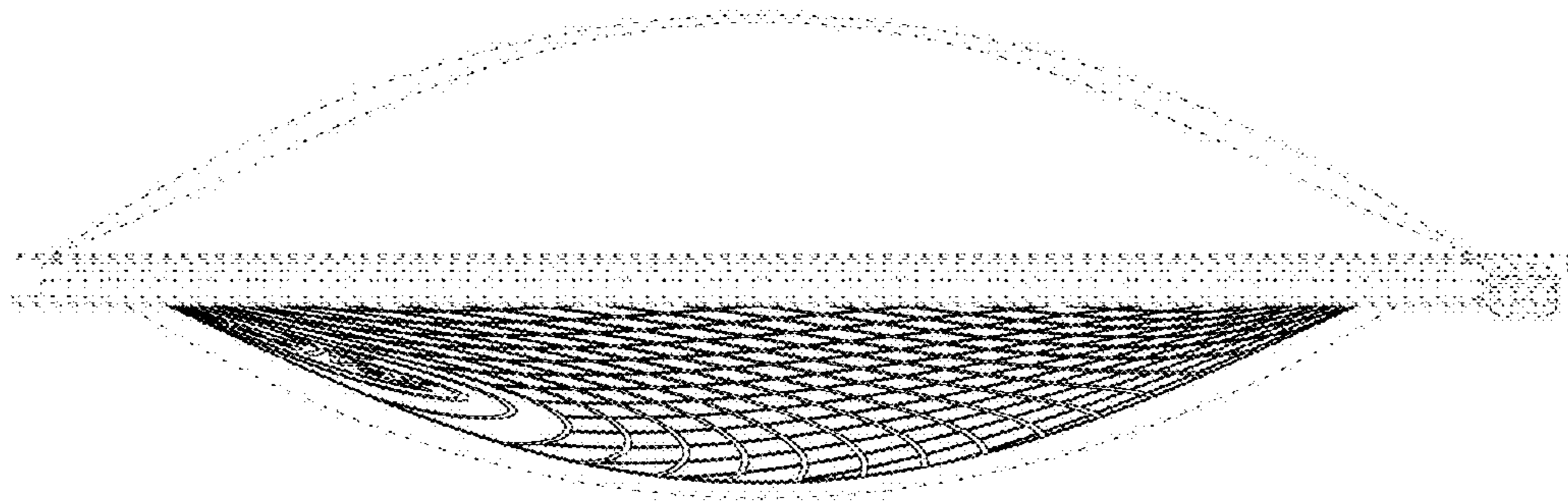

FIG. 13

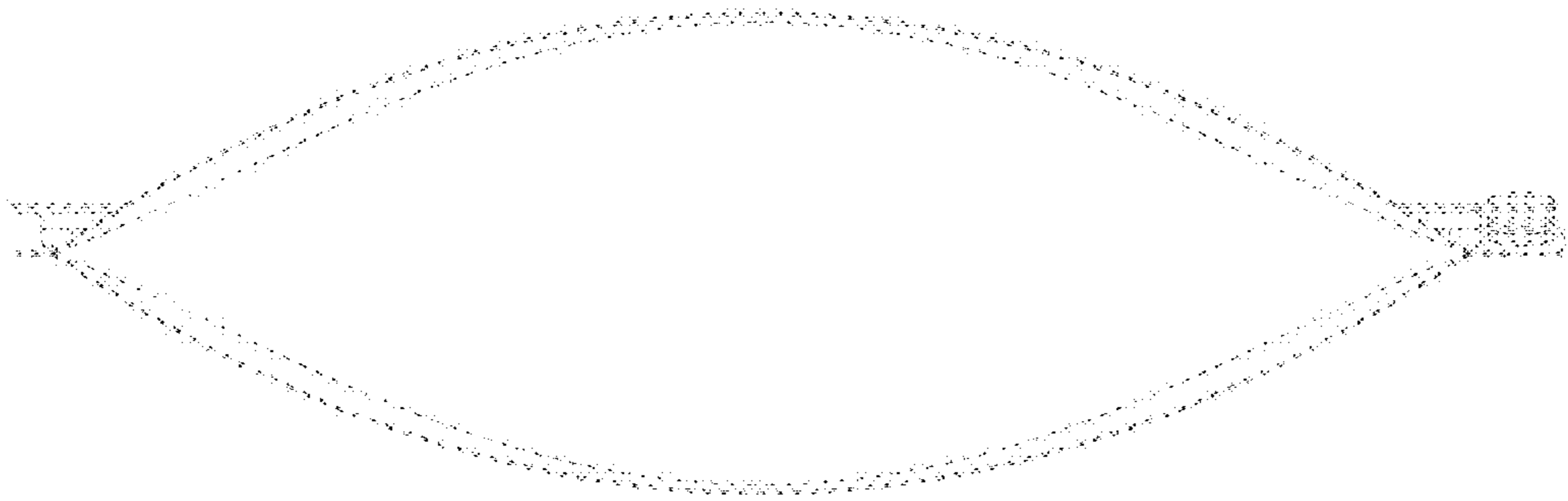

FIG. 14