



US00D971651S

(12) **United States Design Patent** (10) **Patent No.:** **US D971,651 S**  
**Dejesus et al.** (45) **Date of Patent:** **\*\* Dec. 6, 2022**

(54) **RETAIL FIXTURE**

FOREIGN PATENT DOCUMENTS

(71) Applicant: **Apple Inc.**, Cupertino, CA (US)

DE 40110180-0009 7/2003  
EM 002306258-0008 9/2013

(72) Inventors: **Manuel Dejesus**, San Francisco, CA (US); **Joshua Robert Edwards**, Santa Cruz, CA (US); **Jean-Marc Gady**, Los Altos, CA (US); **Wesley Bryan Hamm**, San Francisco, CA (US); **Russell John Kaaihue Heirakuji**, Cupertino, CA (US); **Allison Inouye**, San Francisco, CA (US); **Moritz Wilsberg**, Rheinbreitbach (DE)

(Continued)

OTHER PUBLICATIONS

Japanese Patent Office document HB11011472, Abitare Magazine, p. 61, vol. 386 (2 Pages).

(Continued)

*Primary Examiner* — Kelley A Donnelly

(73) Assignee: **Apple Inc.**, Cupertino, CA (US)

(74) *Attorney, Agent, or Firm* — Sterne, Kessler, Goldstein & Fox P.L.L.C.

(\*\*) Term: **15 Years**

(57) **CLAIM**

(21) Appl. No.: **29/810,693**

The ornamental design for a retail fixture, as shown and described.

(22) Filed: **Oct. 7, 2021**

**DESCRIPTION**

**Related U.S. Application Data**

(63) Continuation of application No. 29/747,620, filed on Aug. 24, 2020, now Pat. No. Des. 932,814, which is a continuation of application No. 29/727,168, filed on Mar. 9, 2020, now Pat. No. Des. 893,922, which is a continuation of application No. 29/655,963, filed on Jul. 9, 2018, now Pat. No. Des. 877,547.

FIG. 1 is a top front perspective view of a retail fixture showing the claimed design;  
FIG. 2 is a front view thereof;  
FIG. 3 is a rear view thereof;  
FIG. 4 is a left side view thereof;  
FIG. 5 is a right side view thereof;  
FIG. 6 is a top view thereof;  
FIG. 7 is a bottom view thereof;  
FIG. 8 is a top front perspective view of a retail fixture showing the claimed design;  
FIG. 9 is a front view thereof;  
FIG. 10 is a rear view thereof;  
FIG. 11 is a left side view thereof;  
FIG. 12 is a right side view thereof;  
FIG. 13 is a top view thereof; and,  
FIG. 14 is a bottom view thereof.  
The broken lines in the figures show portions of the retail fixture that form no part of the claimed design.

(51) **LOC (13) Cl.** ..... **06-06**

(52) **U.S. Cl.**  
USPC ..... **D6/675**

(58) **Field of Classification Search**  
USPC ..... D6/672, 675, 675.1, 682  
(Continued)

(56) **References Cited**

U.S. PATENT DOCUMENTS

D132,875 S 6/1942 Cooper  
3,003,243 A 10/1961 Kanzelberger  
(Continued)

**1 Claim, 14 Drawing Sheets**

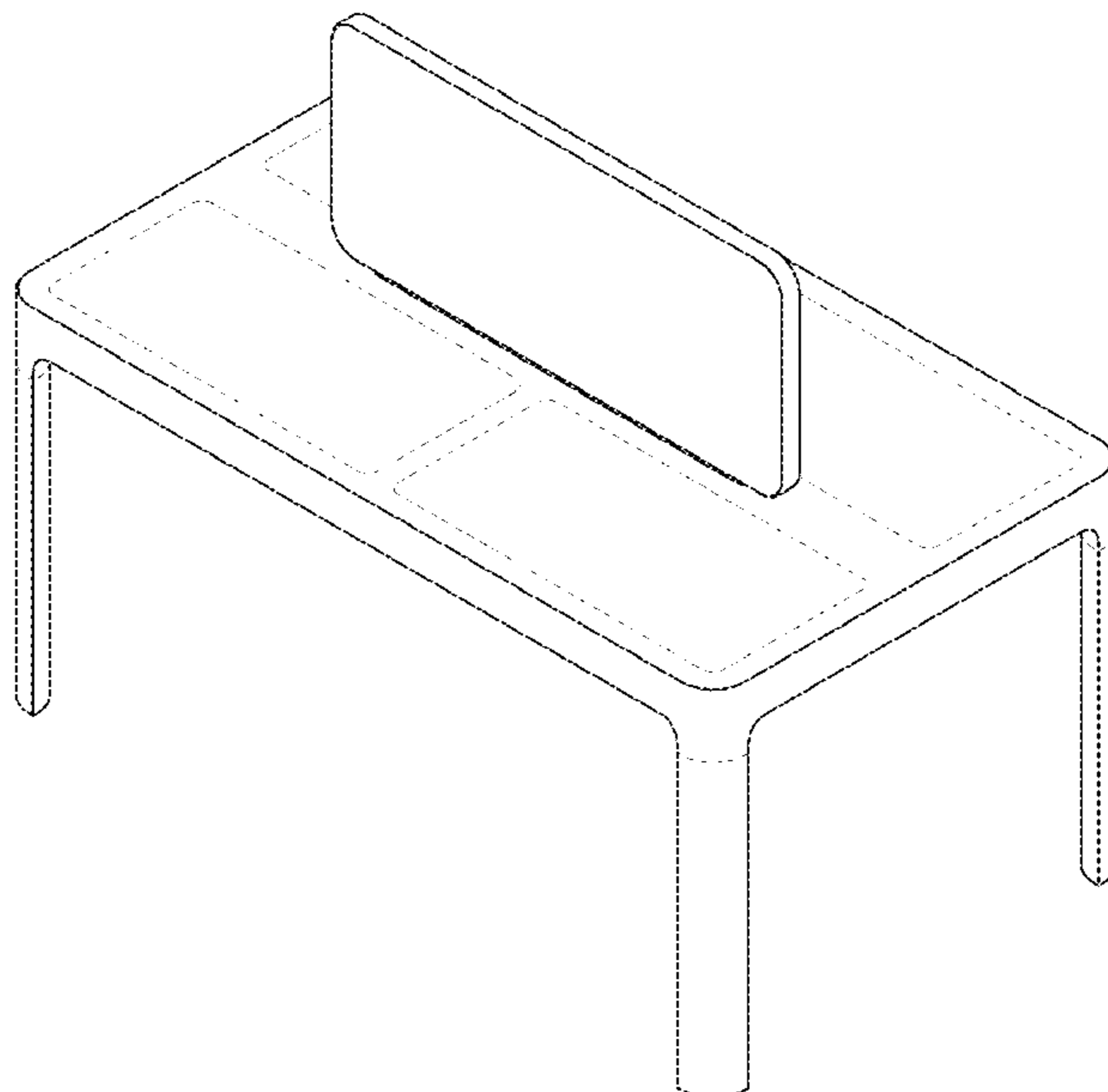

(58) **Field of Classification Search**

CPC ..... A47F 5/00; A47F 5/0018; A47F 5/0043;  
 A47F 7/00; A47F 2007/195; A47B 21/00;  
 A47B 21/04; A47B 81/06  
 See application file for complete search history.

(56) **References Cited**

U.S. PATENT DOCUMENTS

3,289,616 A \* 12/1966 Donihi ..... B25H 1/02  
 108/161  
 D207,972 S \* 6/1967 Bellaire ..... D25/67  
 D214,741 S 7/1969 Dean  
 D218,903 S 10/1970 Chichester  
 D239,584 S \* 4/1976 Vrignaud ..... D6/691.8  
 D242,001 S 10/1976 Carter  
 D243,376 S 2/1977 Scott  
 D243,982 S 4/1977 Carter  
 D248,351 S 7/1978 Bartholomew  
 D264,289 S 5/1982 Klein  
 D264,291 S 5/1982 Haigh  
 D278,584 S 4/1985 Bromley  
 D281,208 S 11/1985 Raftery  
 4,765,253 A 8/1988 Schappach  
 D299,893 S 2/1989 Diehl  
 D300,889 S 5/1989 Bartlett  
 D322,371 S 12/1991 Rosen  
 D329,764 S 9/1992 Evans  
 D350,661 S 9/1994 Klein  
 D399,684 S 10/1998 Glass  
 D407,245 S 3/1999 Lewis  
 D424,841 S 5/2000 Newhouse  
 D426,405 S 6/2000 Newhouse  
 D447,892 S 9/2001 Shih  
 D448,217 S 9/2001 Ullman  
 D453,083 S 1/2002 Hokanson  
 D459,621 S 7/2002 O'Hare et al.  
 D465,201 S \* 11/2002 Gershfeld ..... D13/139.4  
 D468,562 S 1/2003 Chang  
 D484,717 S 1/2004 de Blois  
 D487,655 S 3/2004 Varsi  
 D493,306 S 7/2004 Britschgi  
 D503,298 S 3/2005 Juneau  
 D513,676 S 1/2006 Vaaler  
 D518,981 S 4/2006 O'Hare  
 D522,274 S 6/2006 Coval  
 D522,284 S 6/2006 Shapiro et al.  
 D531,431 S 11/2006 Domack et al.  
 D556,139 S \* 11/2007 Gershfeld ..... D13/139.4  
 D558,489 S 1/2008 Christensen  
 D567,237 S \* 4/2008 Kim ..... D14/371  
 D575,081 S 8/2008 Miyakawa  
 D583,590 S 12/2008 Ellouz  
 D585,218 S 1/2009 Hamilton et al.  
 D590,185 S 4/2009 Karashima  
 D591,079 S 4/2009 Singler et al.  
 D591,979 S 5/2009 Singler et al.  
 D604,063 S 11/2009 Oshinomi et al.  
 D613,968 S 4/2010 Lambert  
 D618,158 S \* 6/2010 Scoley ..... D12/345  
 D620,288 S 7/2010 Stiker Metral  
 D646,507 S 10/2011 Delmestri  
 D647,333 S 10/2011 Navone  
 D649,380 S 11/2011 Townsend  
 D649,381 S 11/2011 Mainzer  
 D655,949 S 3/2012 Villiers et al.  
 D657,978 S 4/2012 Hamm et al.  
 D659,433 S \* 5/2012 Starck ..... D6/656.19  
 D661,129 S 6/2012 Schweikarh et al.  
 D670,104 S 11/2012 Li et al.  
 D674,625 S 1/2013 Mecherle et al.  
 D675,462 S 2/2013 Petrovich  
 D678,696 S 3/2013 Hamm et al.  
 D679,521 S 4/2013 Hamm et al.  
 D683,161 S 5/2013 Polloni  
 D684,413 S 6/2013 Schmitt  
 D688,494 S 8/2013 Hamm et al.

D689,307 S 9/2013 Burt  
 D693,156 S 11/2013 Hamm et al.  
 D710,135 S \* 8/2014 Rasenberg ..... D6/691.8  
 D713,658 S 9/2014 Tio et al.  
 D717,572 S 11/2014 Morrison  
 D725,947 S 4/2015 Tio et al.  
 D726,460 S 4/2015 Arnon et al.  
 D728,281 S 5/2015 Heirakuji et al.  
 D729,560 S 5/2015 Hamm et al.  
 D734,078 S 7/2015 Bougay  
 D734,965 S 7/2015 Tio et al.  
 D736,017 S 8/2015 Rose  
 D746,616 S 1/2016 Akana et al.  
 D753,419 S 4/2016 Heirakuji et al.  
 D757,464 S 5/2016 Chiang  
 D758,106 S 6/2016 Hamm et al.  
 D766,630 S 9/2016 Akana et al.  
 D766,631 S 9/2016 Akana et al.  
 D766,632 S 9/2016 Akana et al.  
 D766,633 S 9/2016 Akana et al.  
 D767,310 S 9/2016 Akana et al.  
 D769,654 S \* 10/2016 Akana ..... D6/691  
 D773,868 S \* 12/2016 Schwalbach ..... D6/695.6  
 D776,471 S 1/2017 Mandon et al.  
 D779,244 S 2/2017 Akana et al.  
 D780,491 S \* 3/2017 Magargee ..... D6/349  
 D781,086 S 3/2017 Velez et al.  
 D783,324 S 4/2017 Akana et al.  
 9,635,931 B2 5/2017 Mandon et al.  
 D788,506 S 6/2017 Choi  
 D790,262 S 6/2017 Akana et al.  
 D799,250 S 10/2017 Schwalbach et al.  
 D799,866 S 10/2017 Pocci et al.  
 D810,476 S 2/2018 Heirakuji et al.  
 D810,482 S 2/2018 Modlin  
 D815,474 S 4/2018 Modlin  
 D827,346 S \* 9/2018 Lowsky ..... D6/691.8  
 D833,789 S 11/2018 Schwalbach et al.  
 D837,578 S 1/2019 Rundle  
 D855,358 S 8/2019 Adler et al.  
 D865,413 S 11/2019 Chapuis et al.  
 D865,419 S 11/2019 Chavarria  
 D867,035 S 11/2019 Brugger et al.  
 D873,056 S 1/2020 Stafford et al.  
 D877,547 S 3/2020 DeJesus et al.  
 D893,922 S \* 8/2020 DeJesus ..... D6/675  
 D946,325 S \* 3/2022 Inouye ..... D6/675  
 2005/0268823 A1 12/2005 Bakker et al.  
 2006/0096506 A1 5/2006 Brauning et al.  
 2009/0095204 A1 4/2009 Levy et al.  
 2009/0165679 A1 7/2009 Bakker et al.  
 2010/0290215 A1 11/2010 Metcalf et al.  
 2011/0297052 A1 12/2011 Martin et al.  
 2013/0081559 A1 4/2013 Roh  
 2014/0124641 A1 5/2014 Kassanoff et al.  
 2015/0150370 A1 6/2015 Korb et al.  
 2015/0173505 A1 \* 6/2015 Mirth ..... A47B 17/00  
 211/186  
 2016/0064995 A1 3/2016 Schwalbach et al.  
 2016/0255957 A1 9/2016 Tsuchiyama et al.  
 2017/0051771 A1 2/2017 Feinstein  
 2022/0092571 A1 \* 3/2022 Ahn ..... G06Q 20/204

FOREIGN PATENT DOCUMENTS

JP D1345526 S 12/2008  
 KR 167611 8/1995  
 WO WODM-074057 10/2010  
 WO DM/078433 6/2012

OTHER PUBLICATIONS

Japanese Patent Office Document HB06003569, dated by JPO Oct. 31, 1993.  
 Japanese Patent Office Document HA14019873, dated by JPO Dec. 1, 2012.  
 Japanese Patent Office Document HA24006766, dated by JPO Sep. 1, 2012.

(56)

**References Cited**

OTHER PUBLICATIONS

Japanese Patent Office Document HC13007386.

Neil Hughes, "Apple retail stores 'bulging at the seams' at 8400 average square feet," Appleinsider.com, dated May 8, 2012, accessed at <[http://appleinsider.com/articles/12/05/08/apple\\_retail\\_stores\\_bulging\\_at\\_the\\_seams\\_at\\_8400\\_average\\_square\\_feet](http://appleinsider.com/articles/12/05/08/apple_retail_stores_bulging_at_the_seams_at_8400_average_square_feet)> 2 pages.

Valentina Palladino, "Apple Store Receives Trademark for 'Distinctive Design and Layout,'" Wired.com, dated Jan. 30, 2013, accessed at <<http://www.wired.com/2013/01/apple-store-trademark/>> 2 pages.

"Apple Granted 8 Design Patents for All-New Apple Watch Tables," Patently Apple, Nov. 28, 2015. Retrieved from the Internet: <<http://www.patentlyapple.com/patently-apple/2015/11/apple-granted-8-design-patents-for-all-new-apple-watch-tables.html>>, 6 pages.

Demark, "Kanjana Collection" demarkaward.net, 2009, Available at [https://demarkaward.net/th/demark\\_winner/detail/33-Kanjana%20Collection](https://demarkaward.net/th/demark_winner/detail/33-Kanjana%20Collection).

Hoog-Design, "Kanjana Table" hoog-design.com, Available at <https://hoog-design.com/products/kanjana-table?variant=21234491588685>.

\* cited by examiner

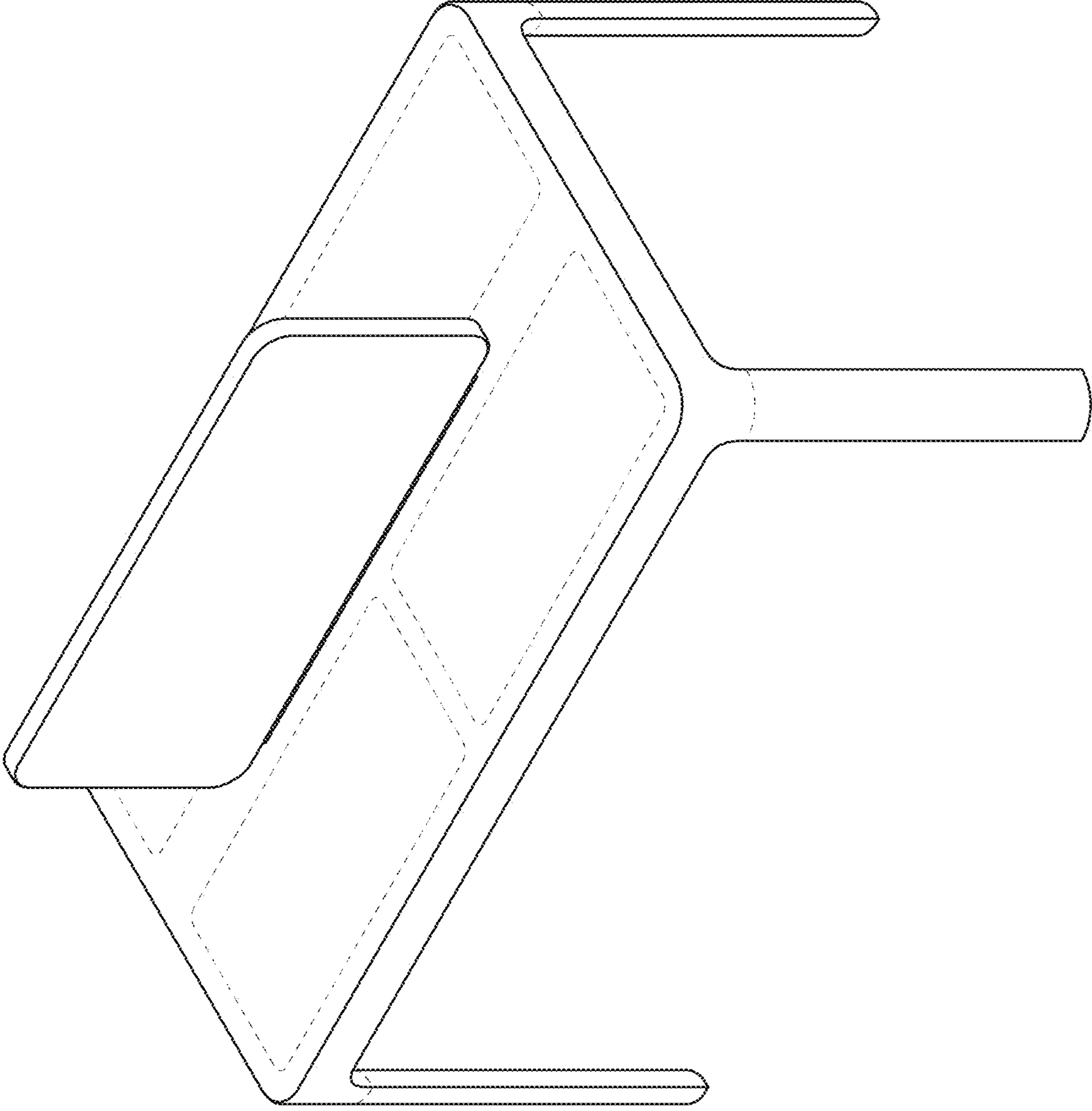

FIG. 1

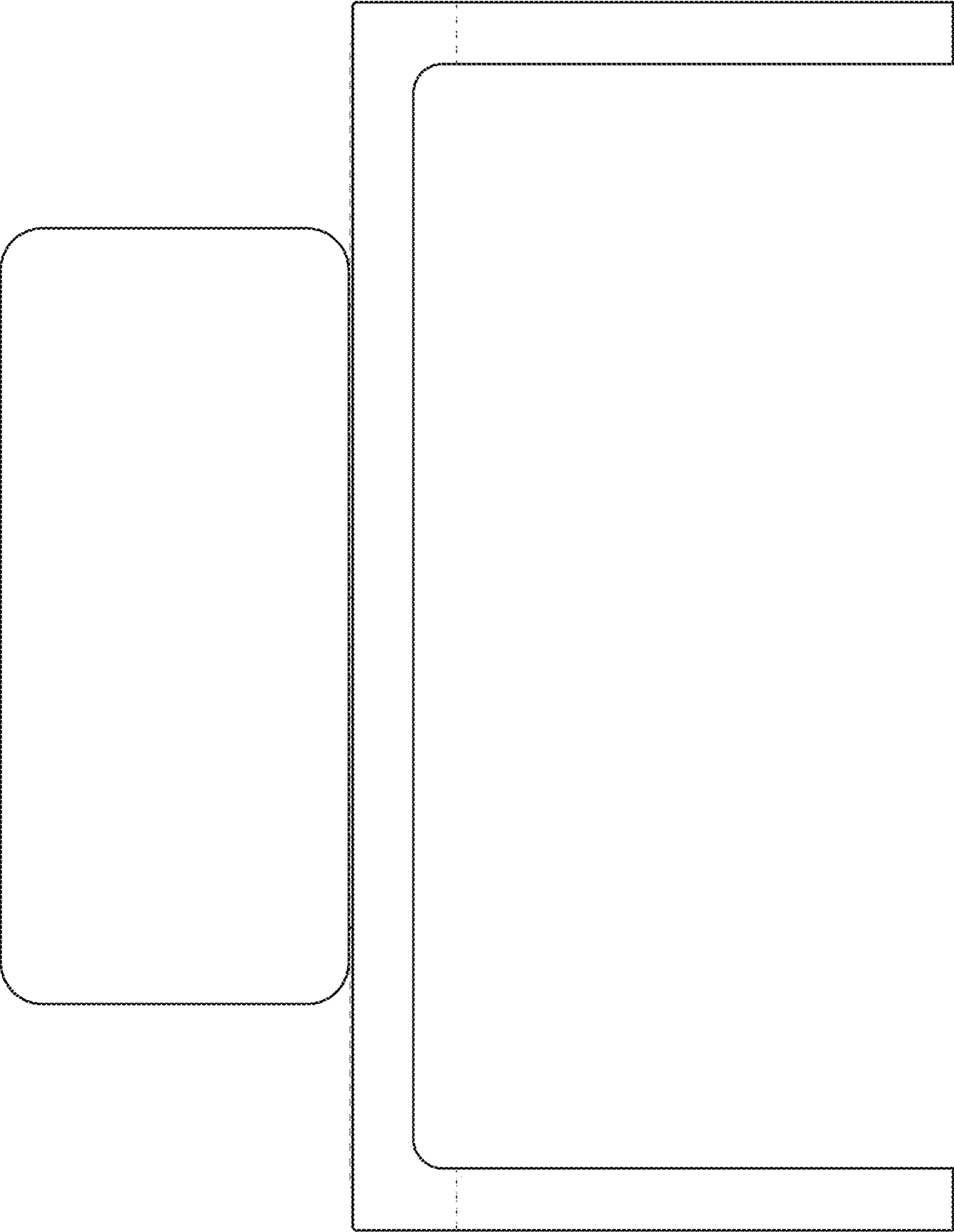

FIG. 2

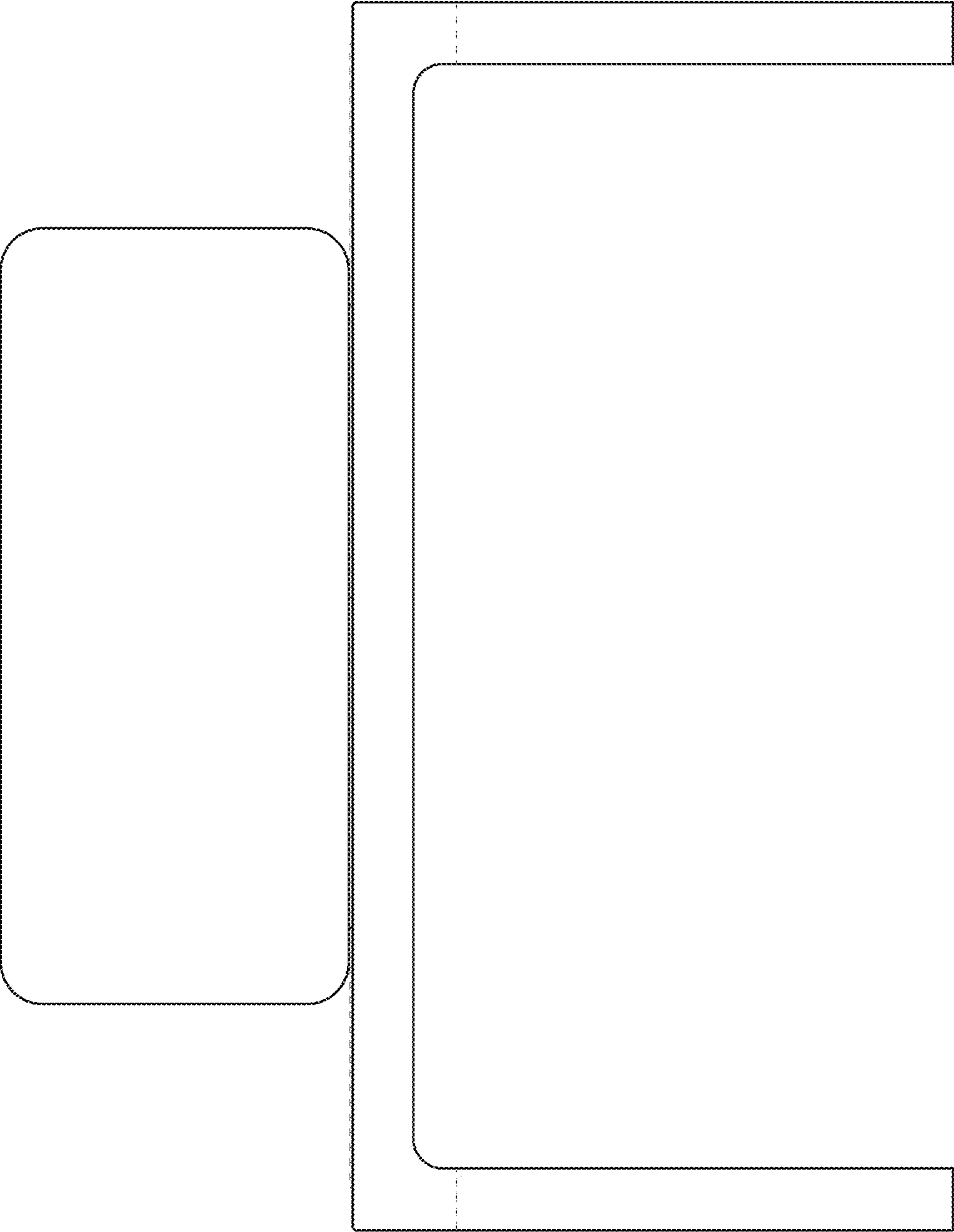

FIG. 3

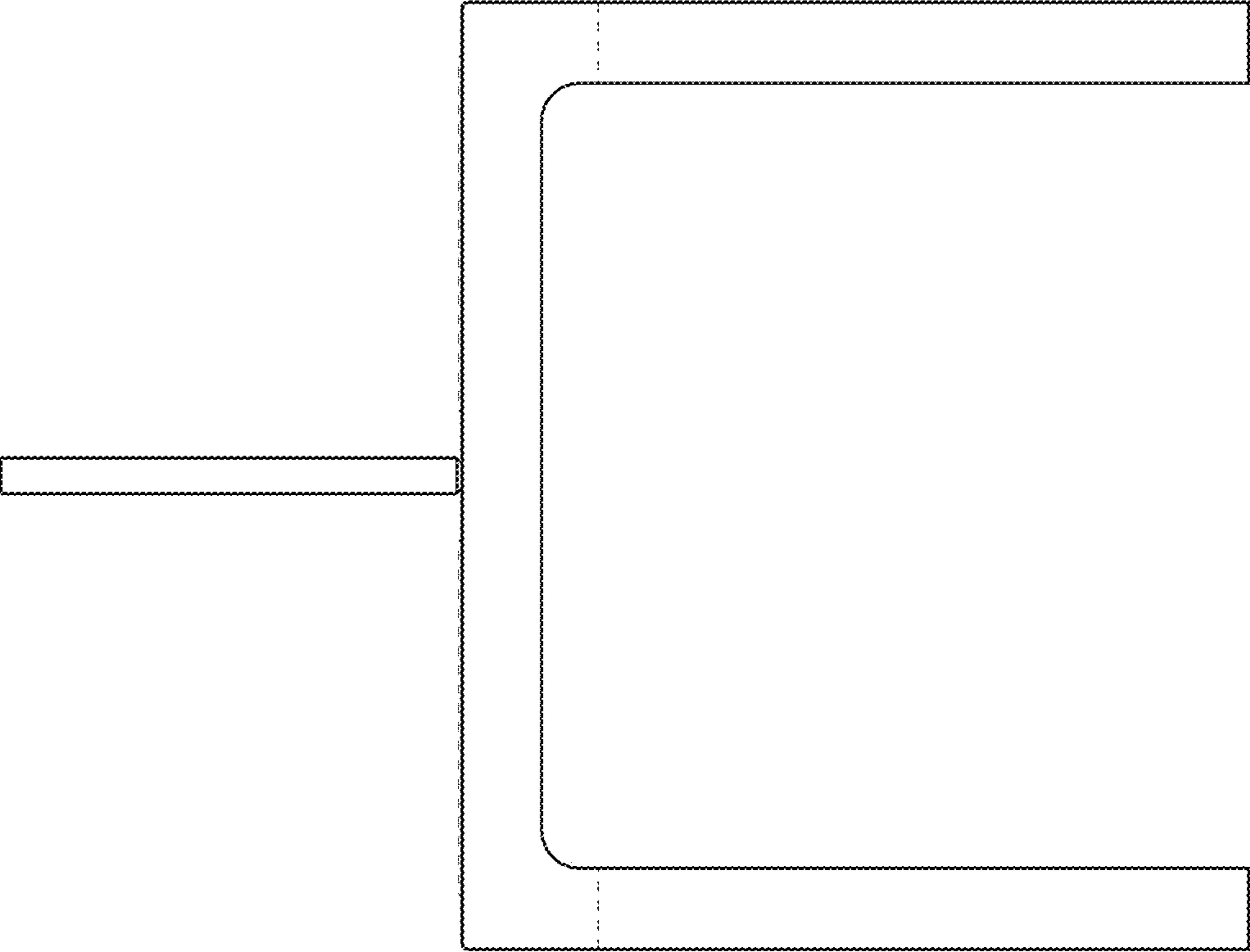

FIG. 4

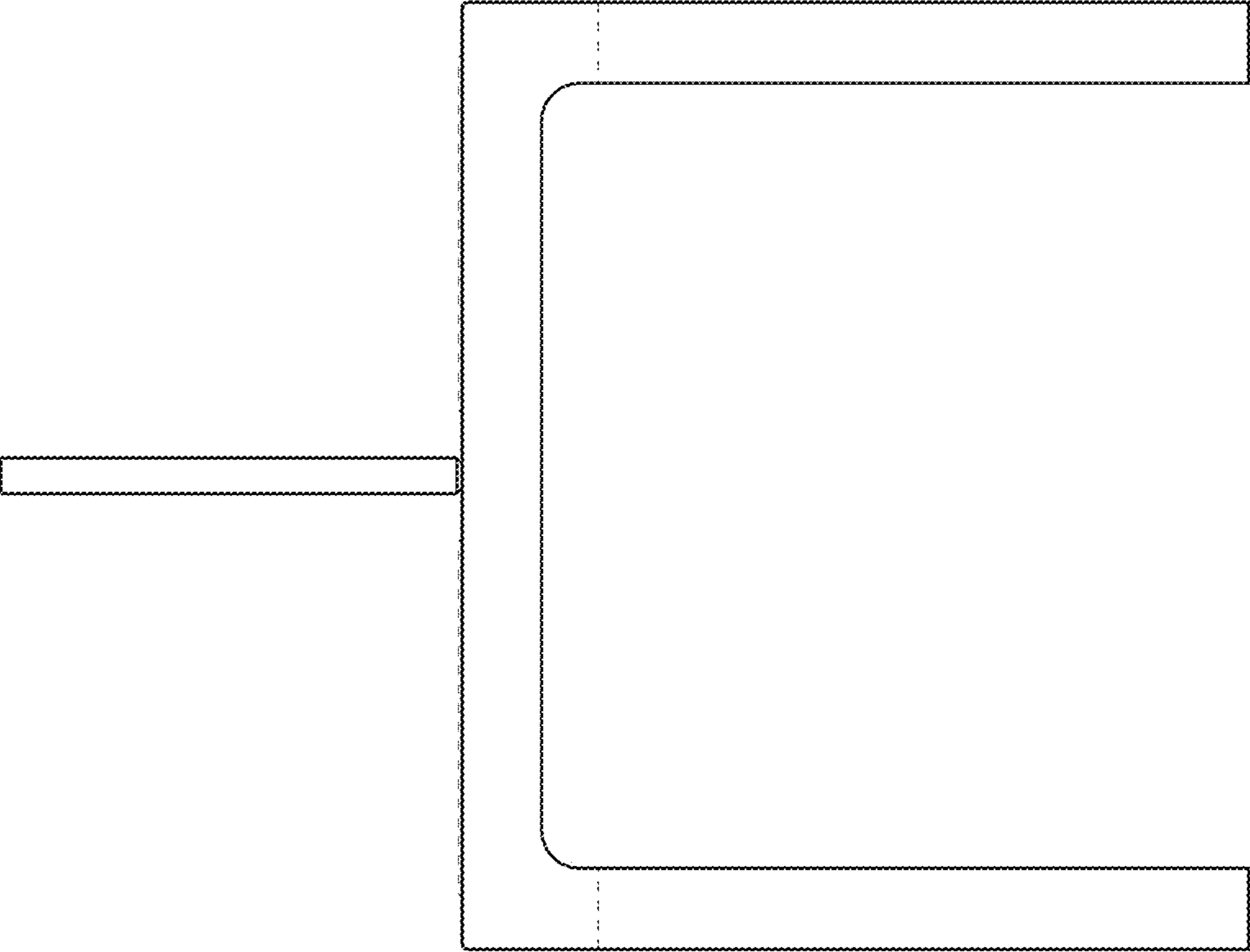

FIG. 5



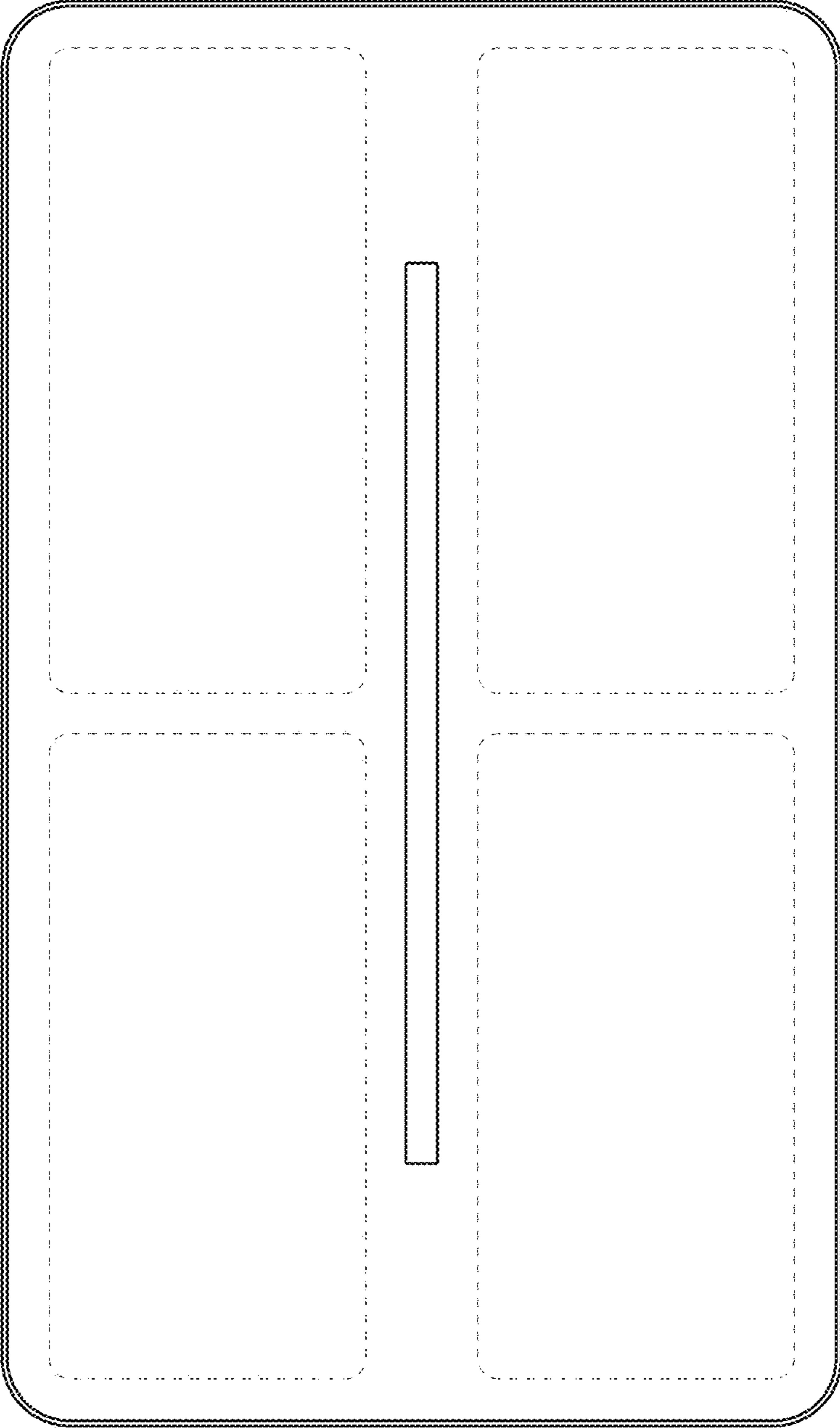

FIG. 6

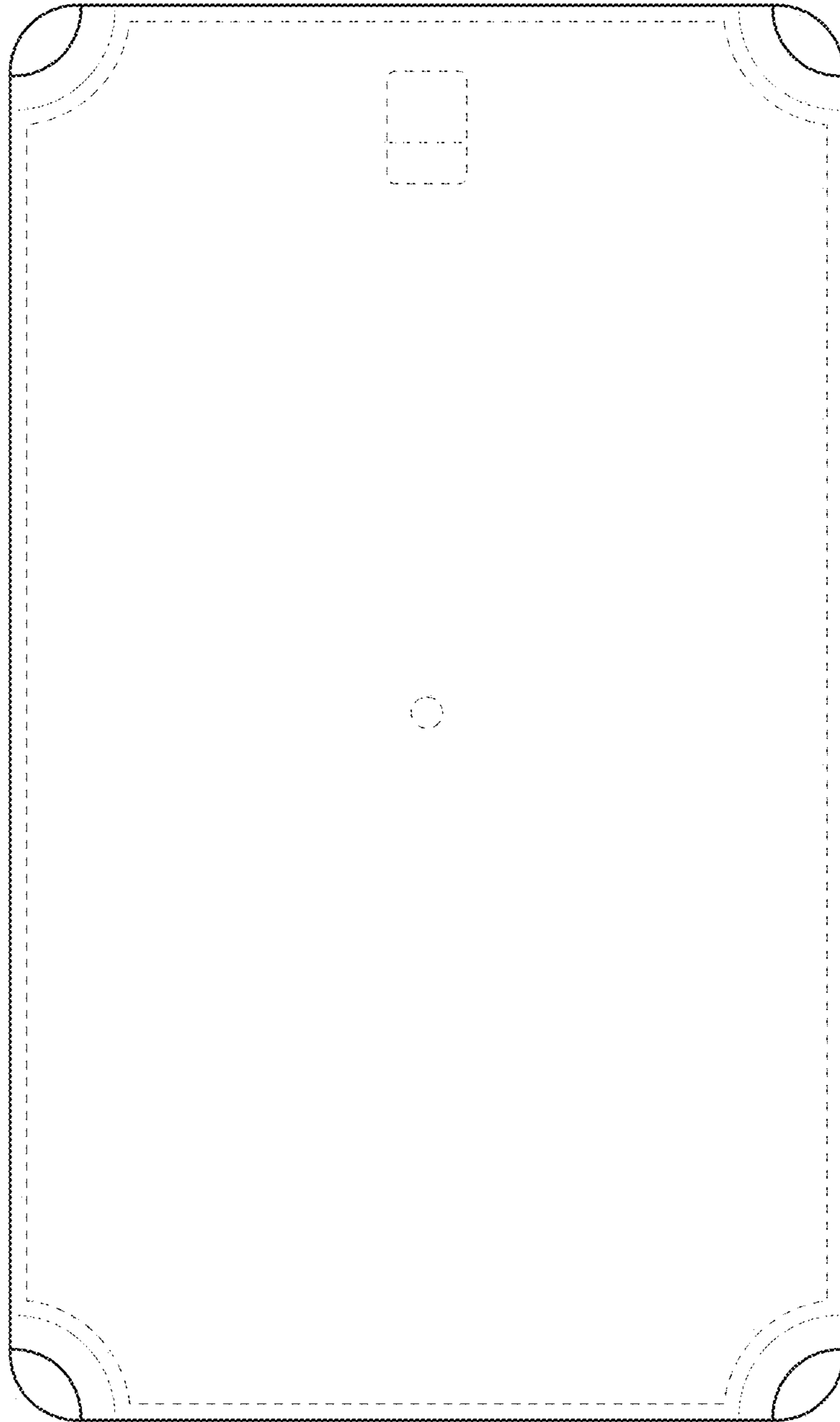

FIG. 7

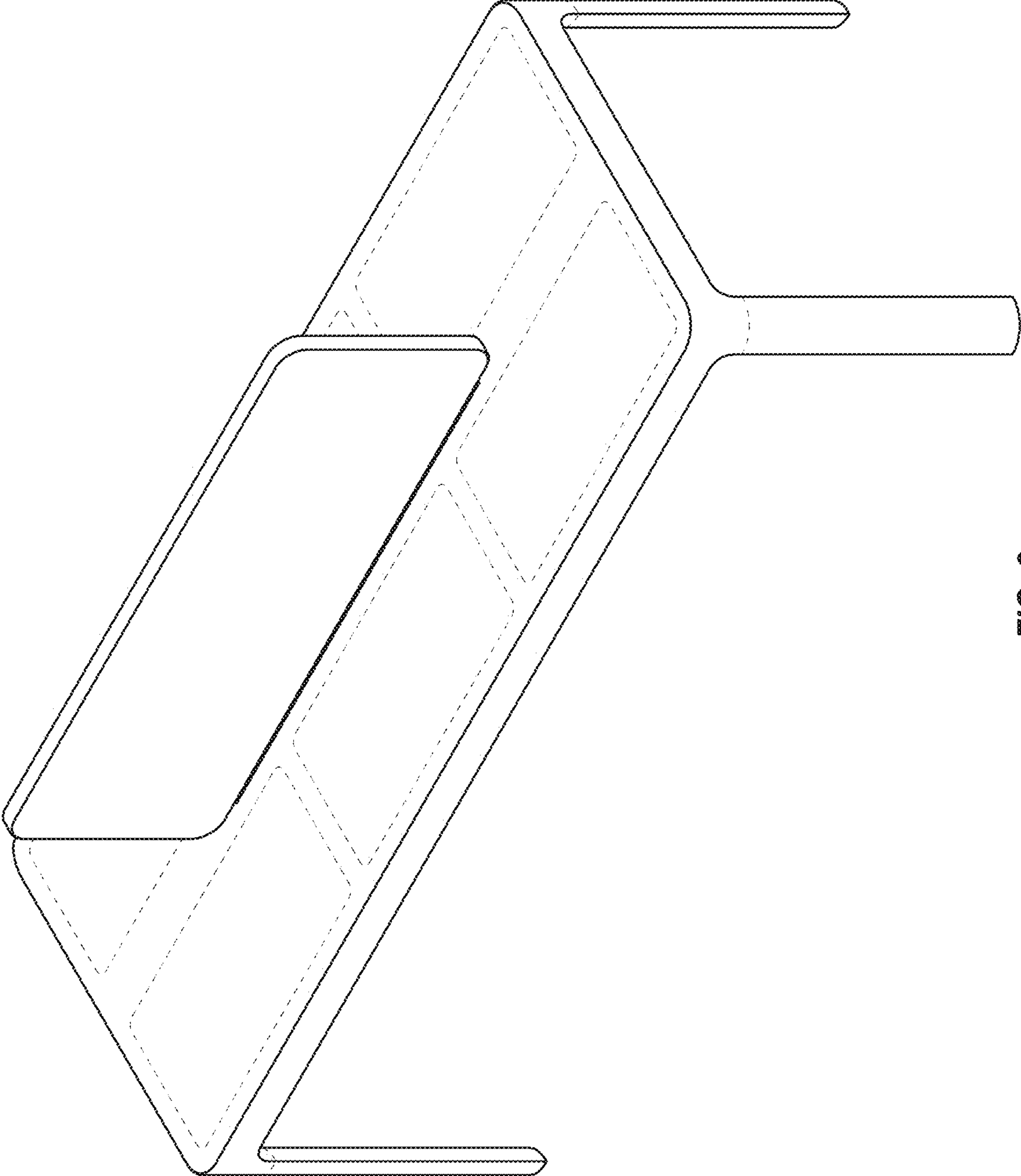

FIG. 8

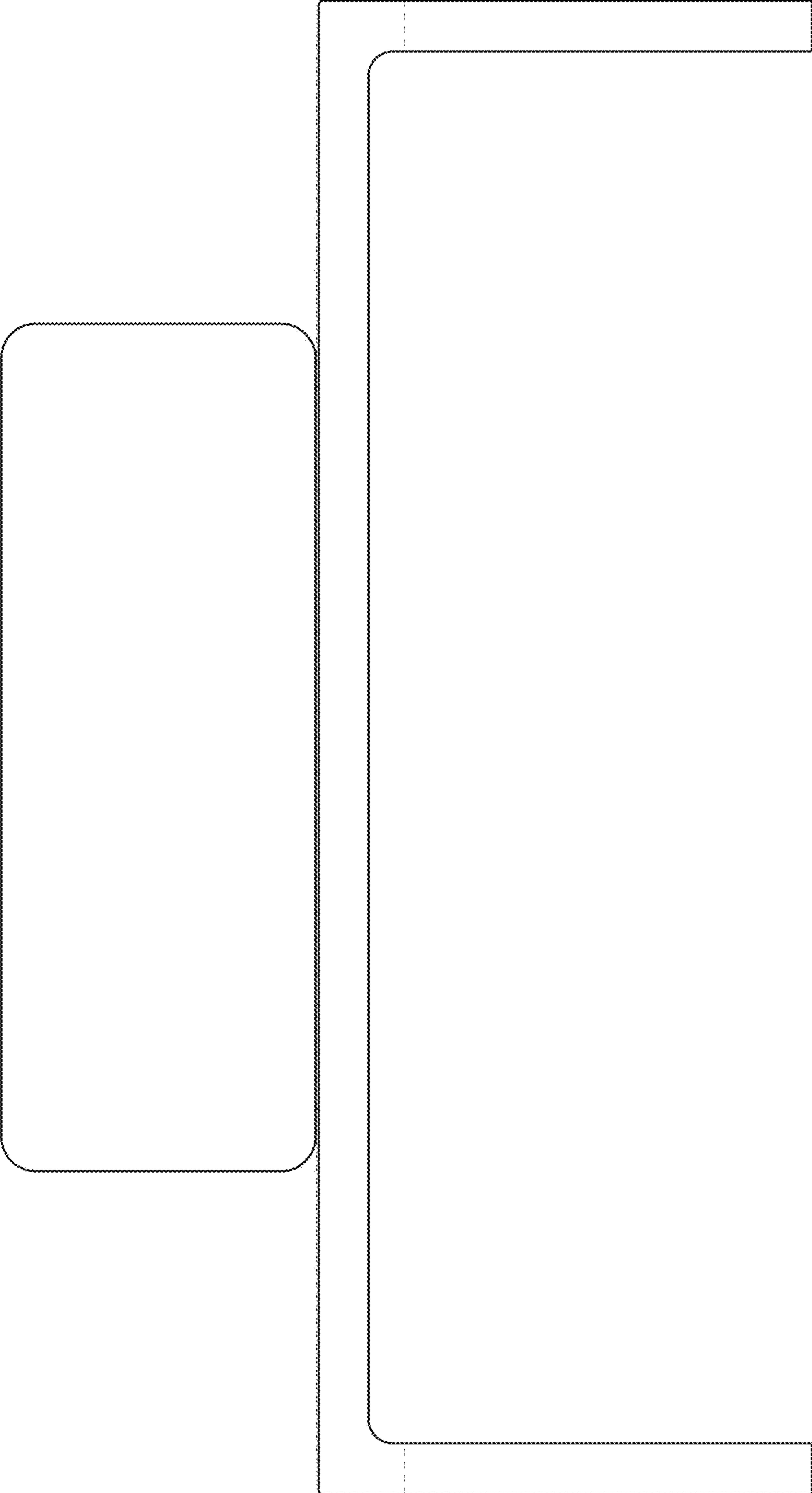

FIG. 9

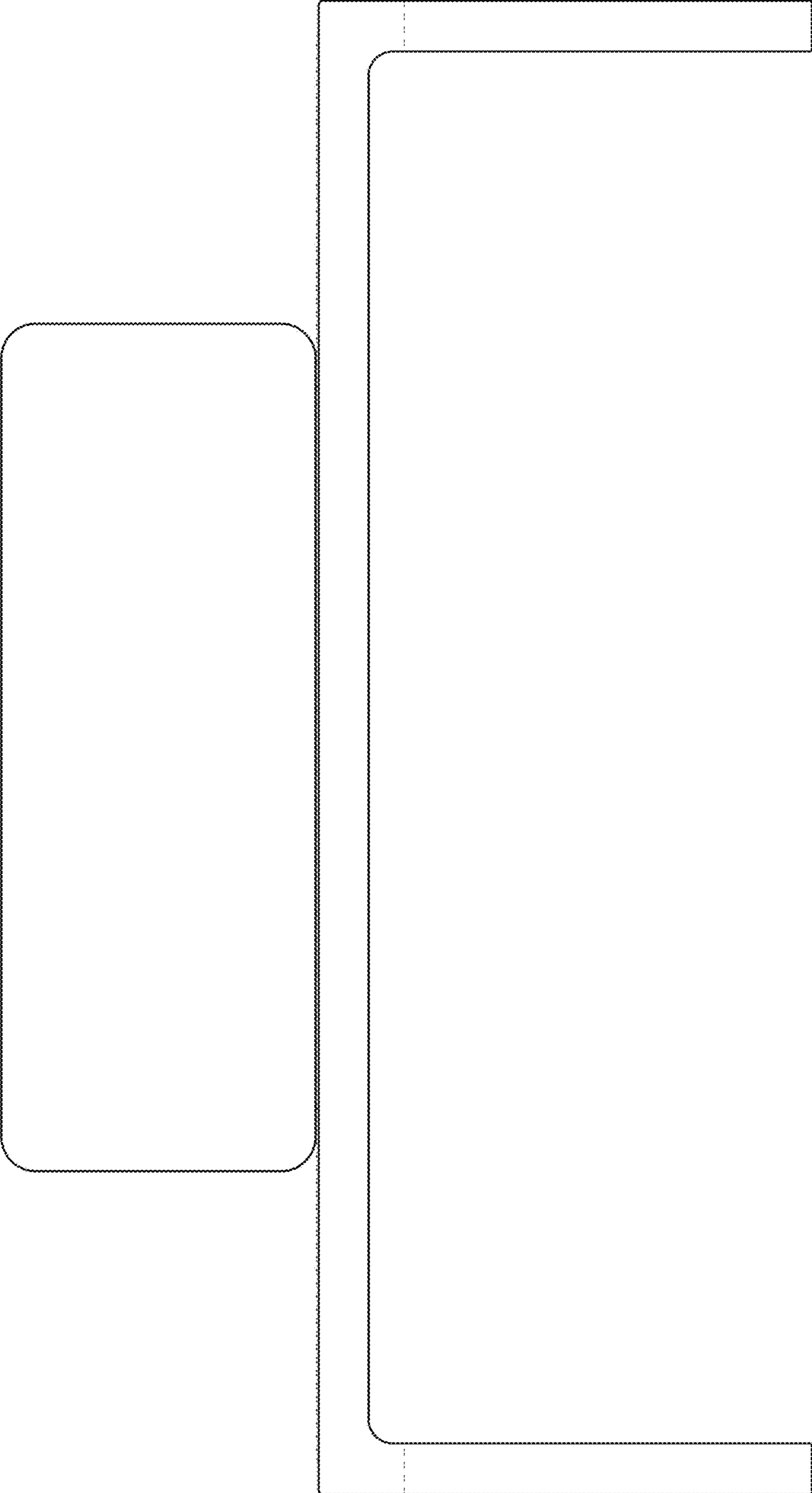

FIG. 10

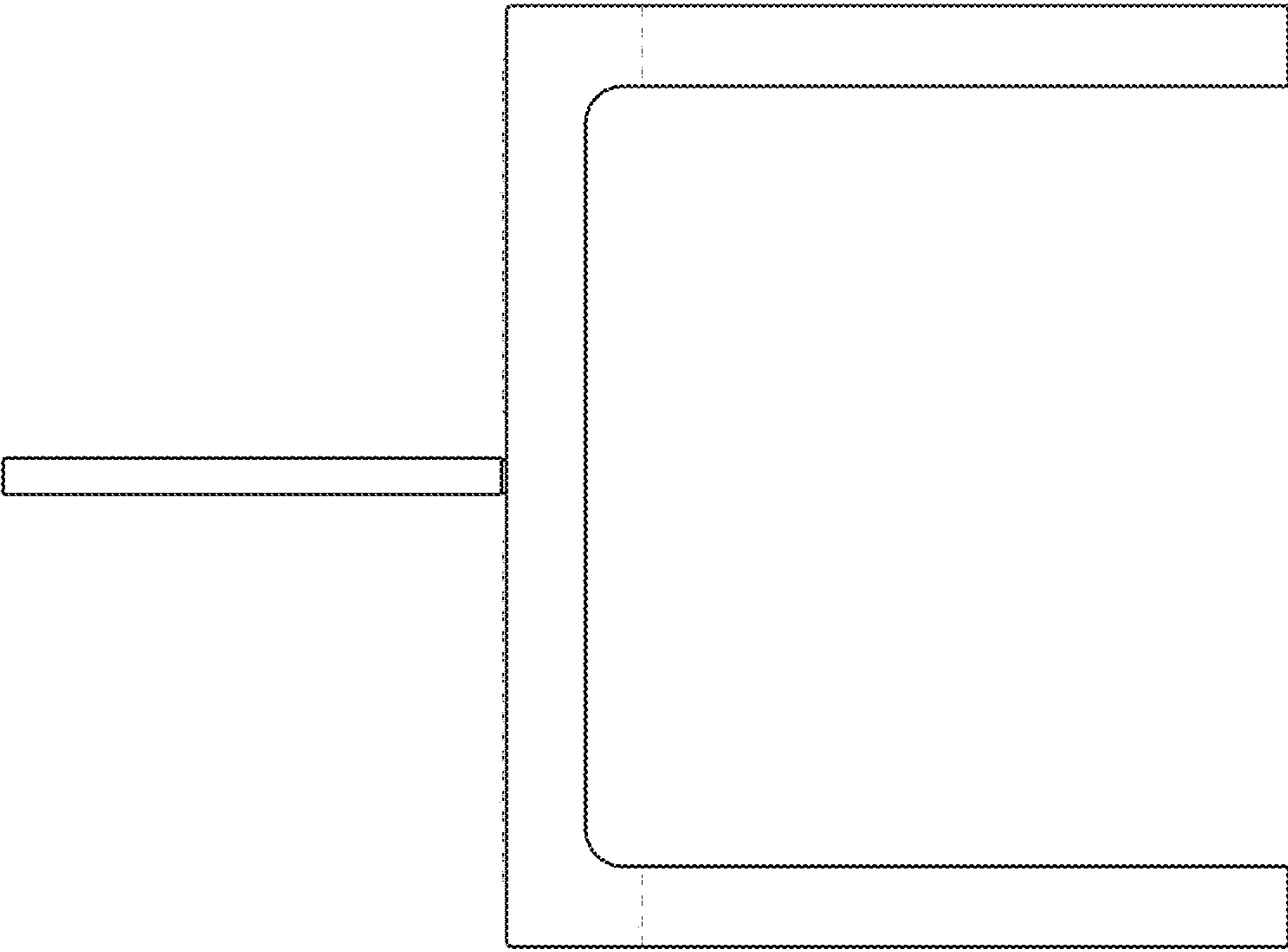

FIG. 11

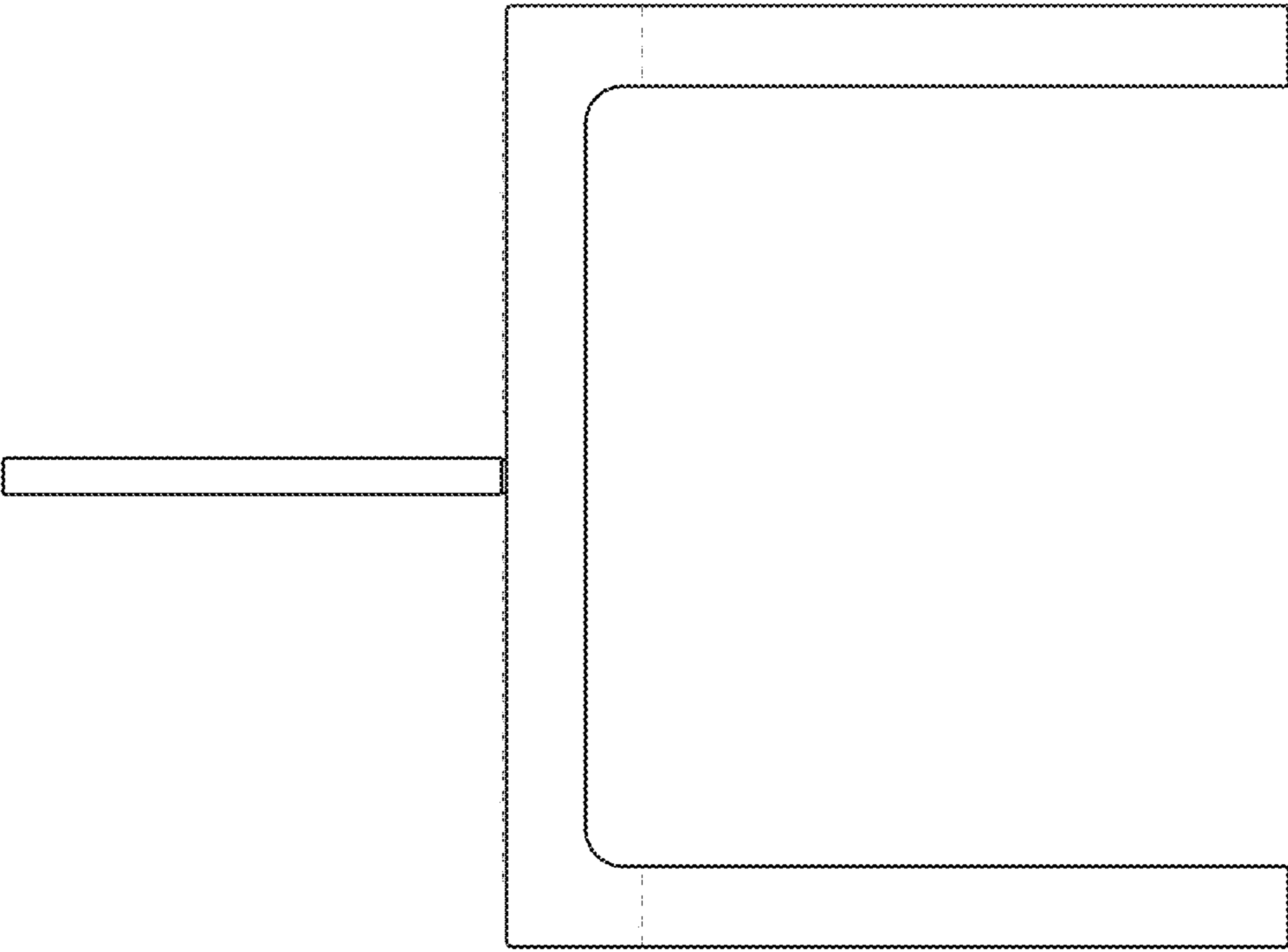

FIG. 12

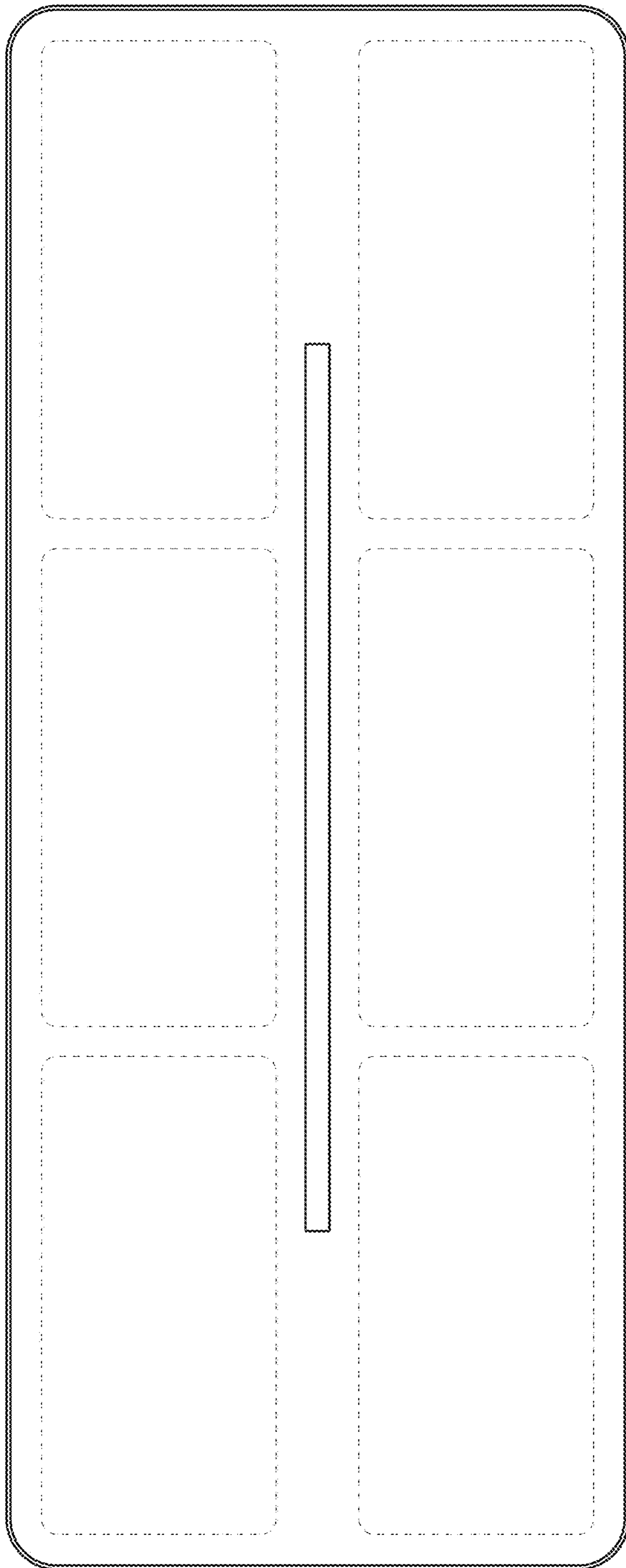

FIG. 13



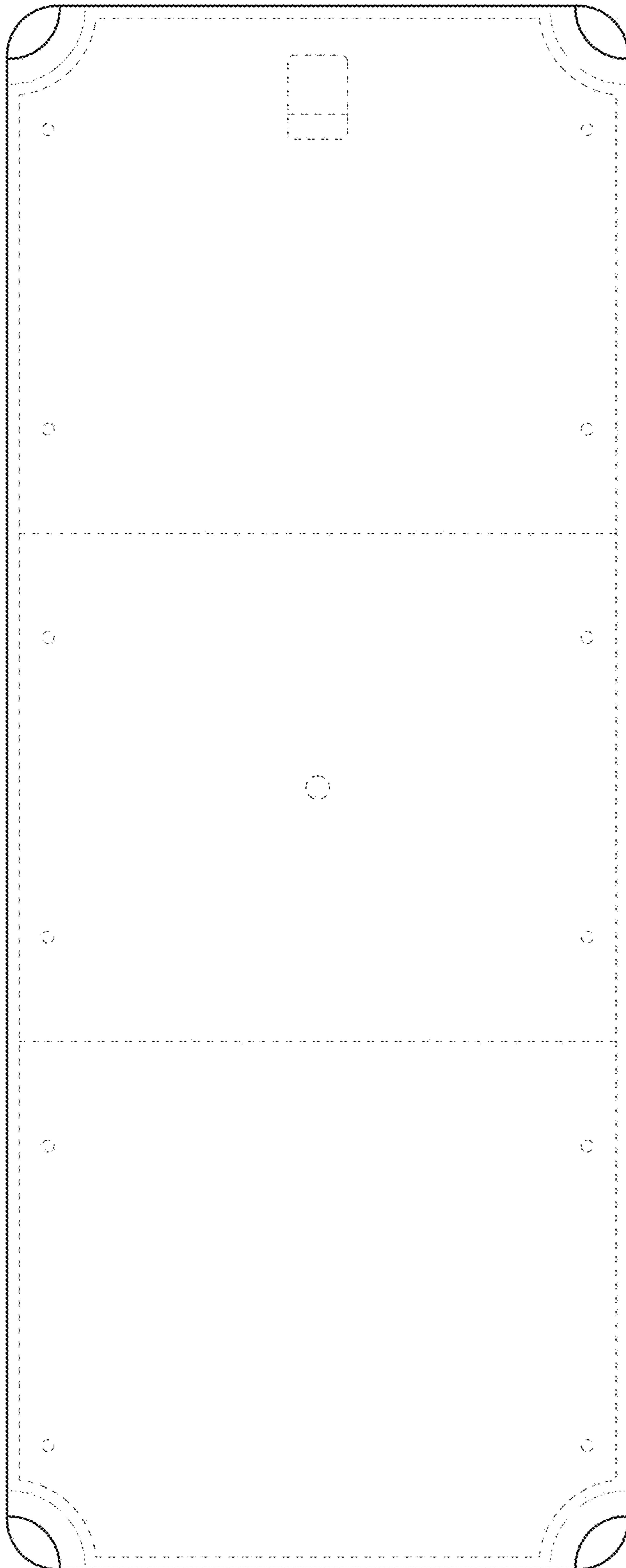

FIG. 14