



US00D971647S

(12) **United States Design Patent** (10) **Patent No.:** **US D971,647 S**
Tong (45) **Date of Patent:** **** Dec. 6, 2022**

(54) **VANITY SET**

(71) Applicant: **Ningbo Yaoqi e-commerce Co., Ltd,**
Ningbo (CN)

(72) Inventor: **Chunbao Tong,** Ningbo (CN)

(**) Term: **15 Years**

(21) Appl. No.: **29/799,084**

(22) Filed: **Jul. 13, 2021**

(51) **LOC (13) Cl.** **06-04**

(52) **U.S. Cl.**

USPC **D6/664.1**

(58) **Field of Classification Search**

USPC D6/300, 308, 657, 663, 664, 664.1, 671,
D6/671.1, 671.2, 671.3, 671.4, 686

CPC A47B 17/04; A47B 67/00; A47B 67/005;
A47B 67/04; A47B 88/00; A47B 88/40;
A47B 43/00; A47B 46/00; A47B 47/00;
A47B 47/022; A47B 47/04; A47B 55/00;
A45D 42/10

See application file for complete search history.

(56) **References Cited**

U.S. PATENT DOCUMENTS

1,813,821 A * 7/1931 Ruebsahm A47B 67/005
312/273
D298,165 S * 10/1988 McLean D6/664.1
D604,960 S 12/2009 Garbin
D637,272 S 5/2011 Du
D829,474 S 10/2018 Neri et al.
D868,506 S * 12/2019 Song D6/664.1

OTHER PUBLICATIONS

FAMAPY Makeup Vanity with Sliding Lighted Mirror Vanity Set
with Storage Drawers Hidden Shelves Cushion Stool White/Grey,
from amazon.com, Date First Avialable: May 14, 2021, pp. 1-14,

from <https://www.amazon.com/FAMAPY-Sliding-Lighted-Storage-Drawers/dp/B094XRBWFP?th=1> (Year: 2021).*

* cited by examiner

Primary Examiner — Mimoso De

(74) *Attorney, Agent, or Firm* — Rumit R. Kanakia

(57) **CLAIM**

The ornamental design for a vanity set, as shown and described.

DESCRIPTION

FIG. 1 is a first perspective view of a first part of a vanity set showing my new design;

FIG. 2 is a second perspective view of a first part thereof;

FIG. 3 is a front view of a first part thereof;

FIG. 4 is a back view of a first part thereof;

FIG. 5 is a left side view of a first part thereof;

FIG. 6 is a right side view of a first part thereof;

FIG. 7 is a top view of a first part thereof;

FIG. 8 is a bottom of a first part thereof;

FIG. 9 is a first perspective view of a second part of a vanity set showing my new design;

FIG. 10 is a second perspective view of a second part thereof;

FIG. 11 is a front view of a second part thereof;

FIG. 12 is a back view of a second part thereof;

FIG. 13 is a left side view of a second part thereof;

FIG. 14 is a right side view of a second part thereof;

FIG. 15 is a top view of a second part thereof;

FIG. 16 is a bottom of a second part thereof;

FIG. 17 is an enlarged view of the selected portion in FIG. 9; and,

FIG. 18 is a perspective view of another state of the second part of a vanity set thereof.

The broken lines shown in the drawings depict portions of the vanity set in which the design is embodied that form no part of the claimed design.

1 Claim, 18 Drawing Sheets

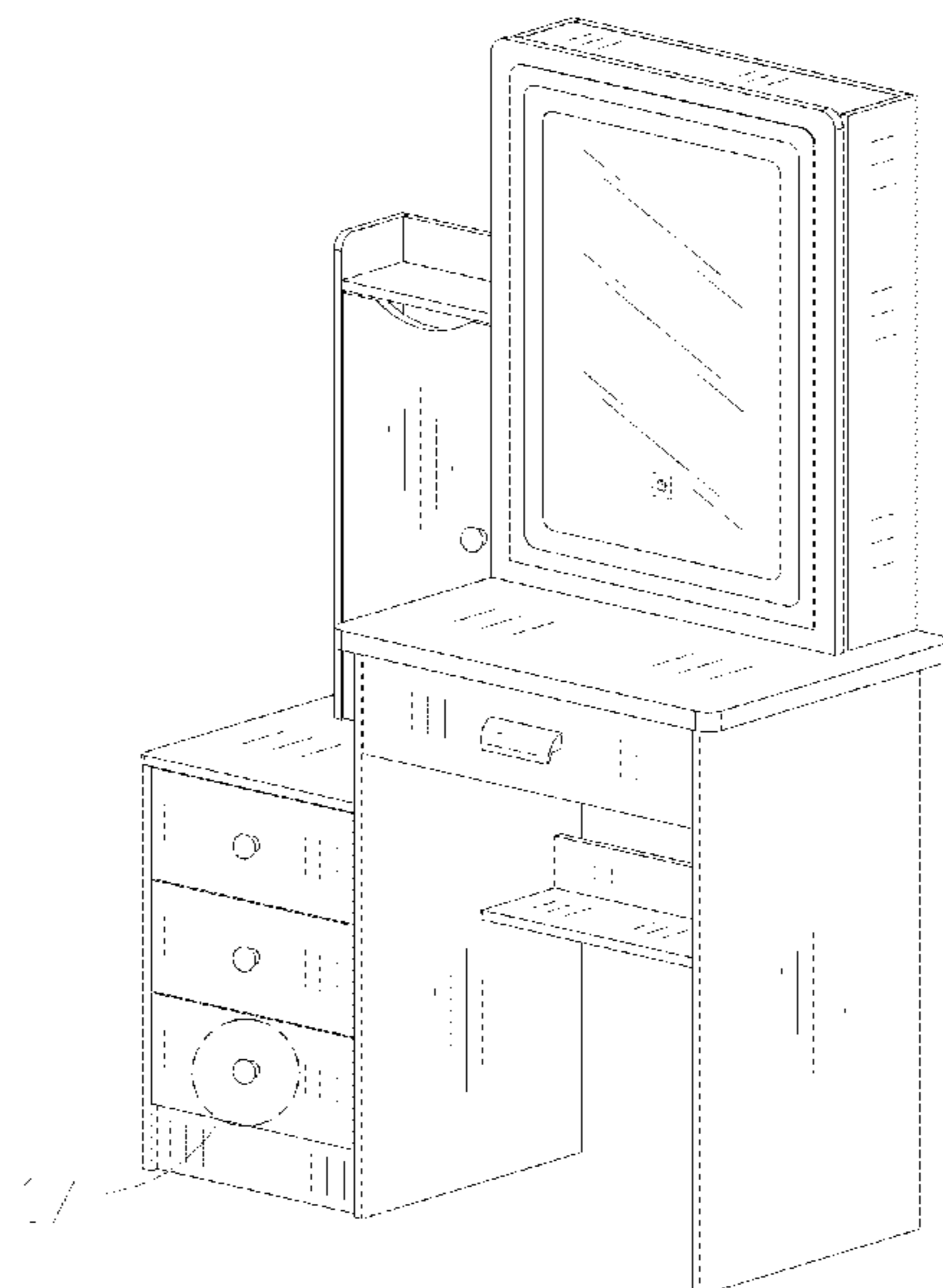

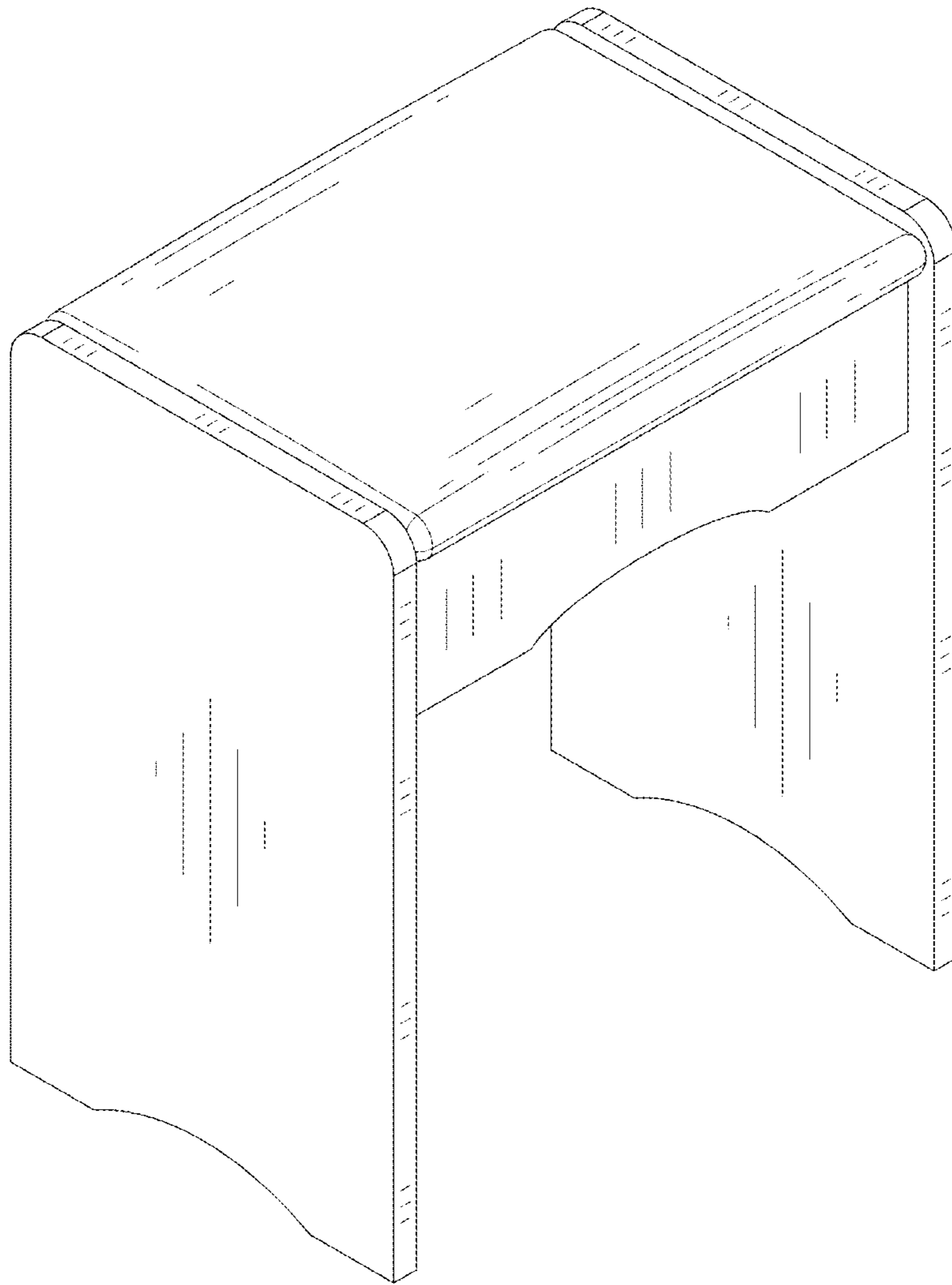

FIG. 1

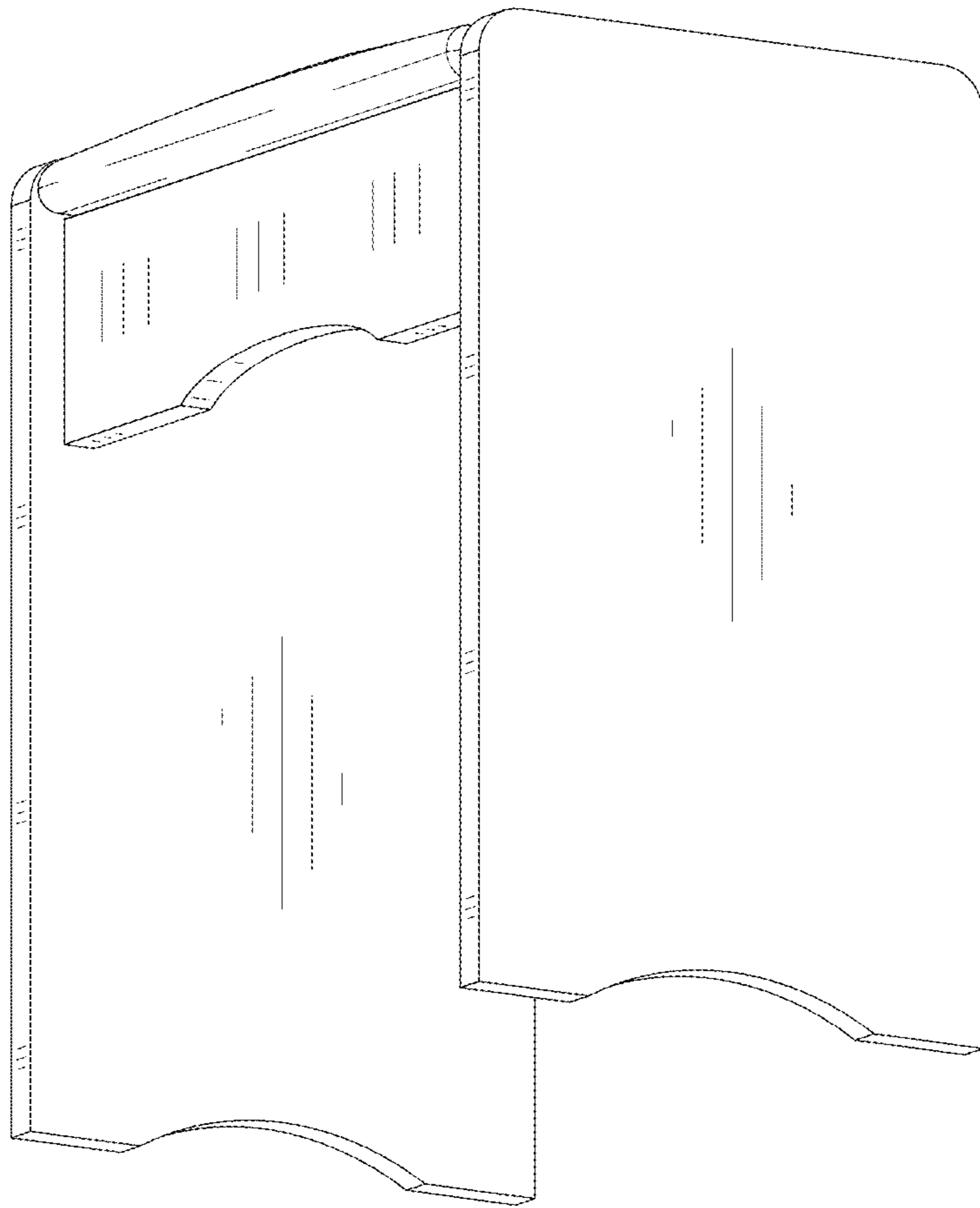

FIG. 2

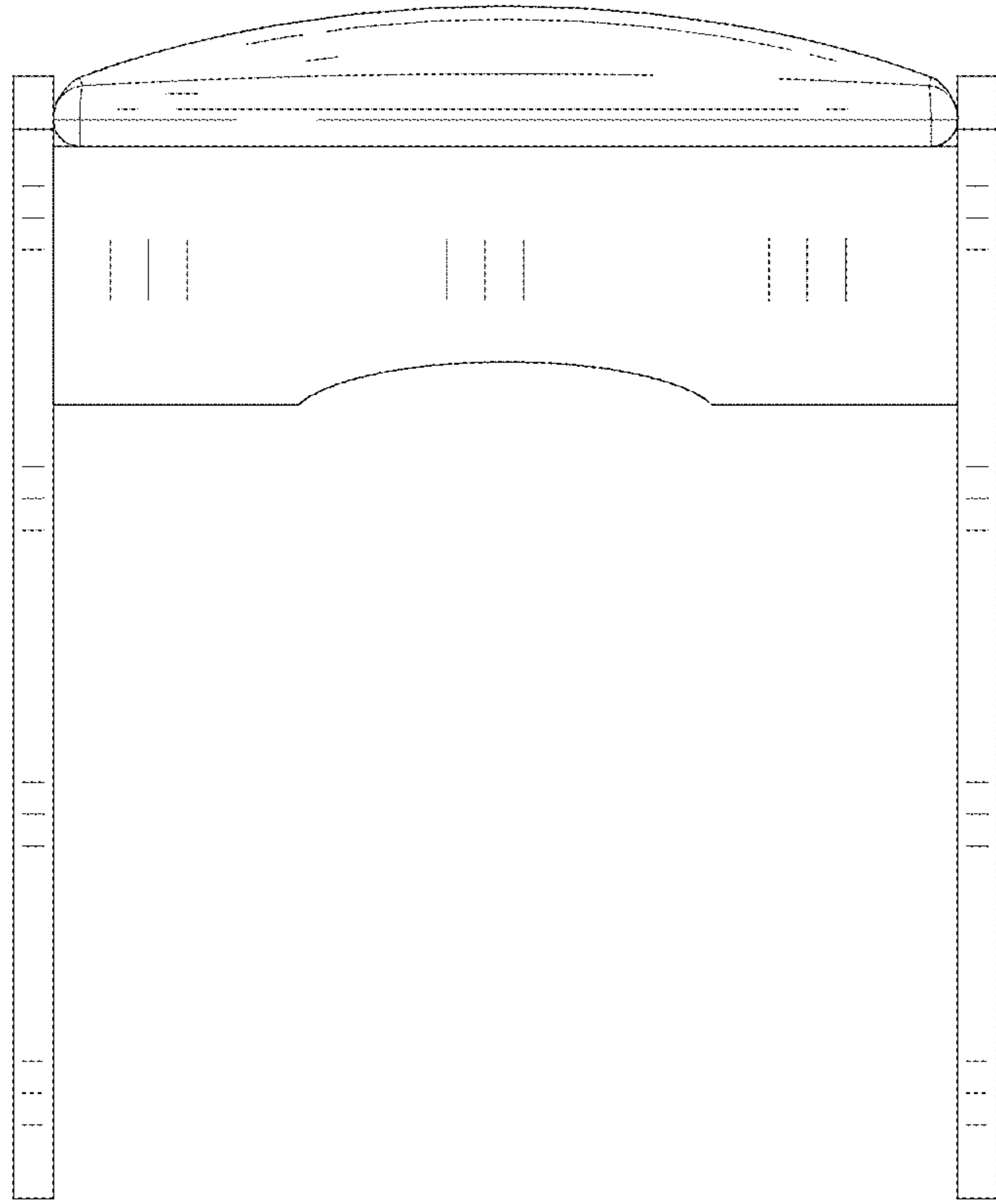

FIG. 3

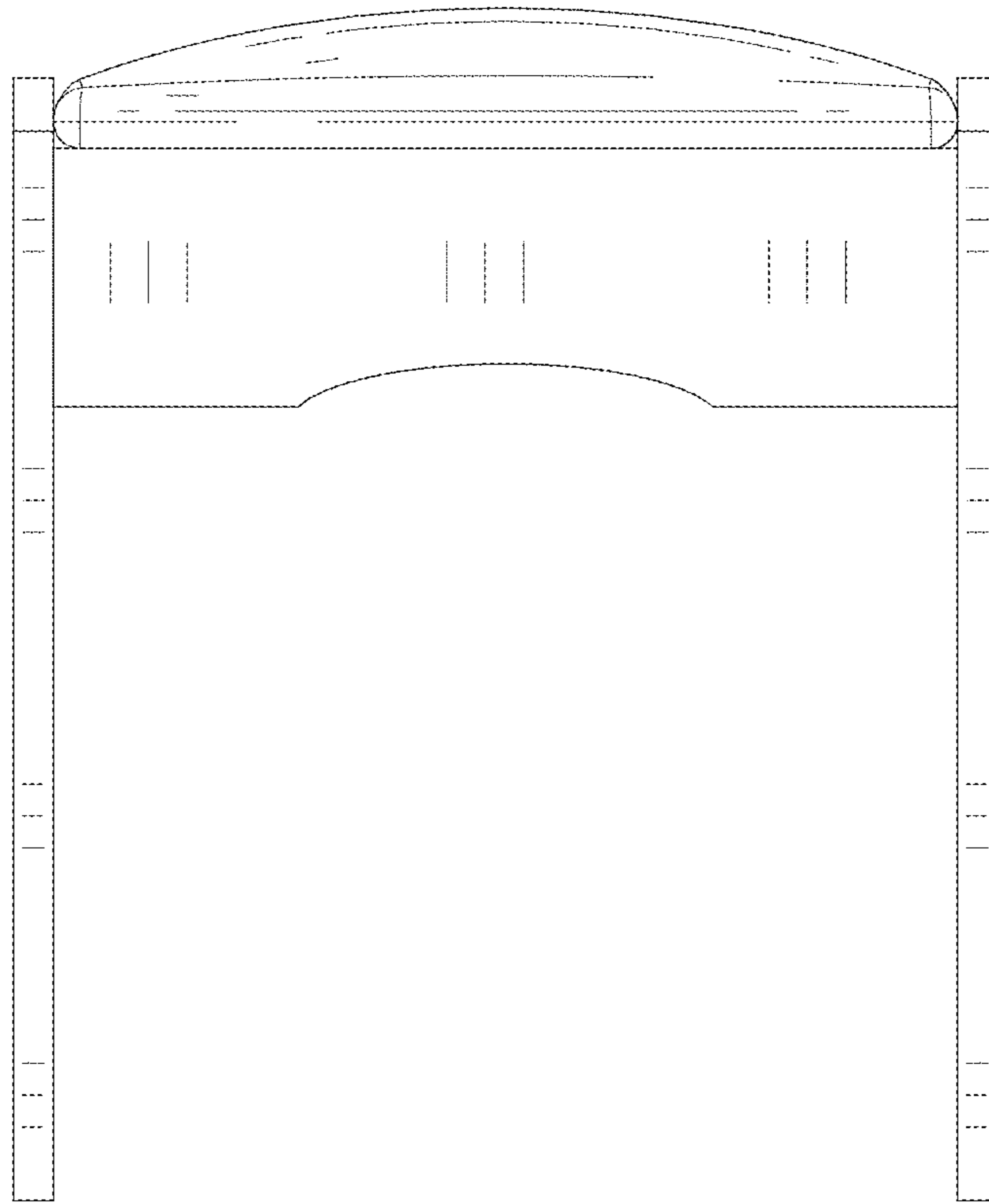

FIG. 4

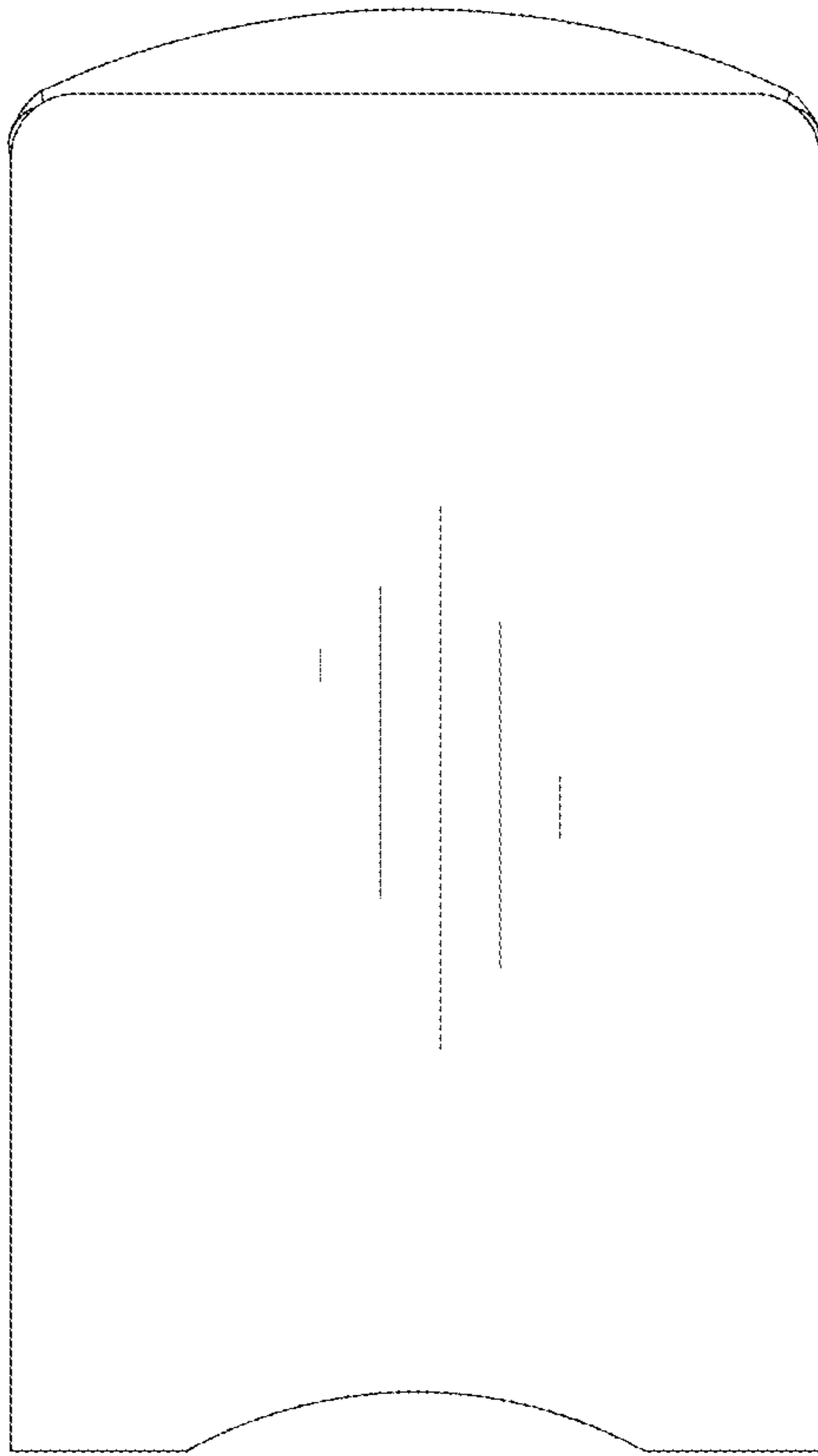

FIG. 5

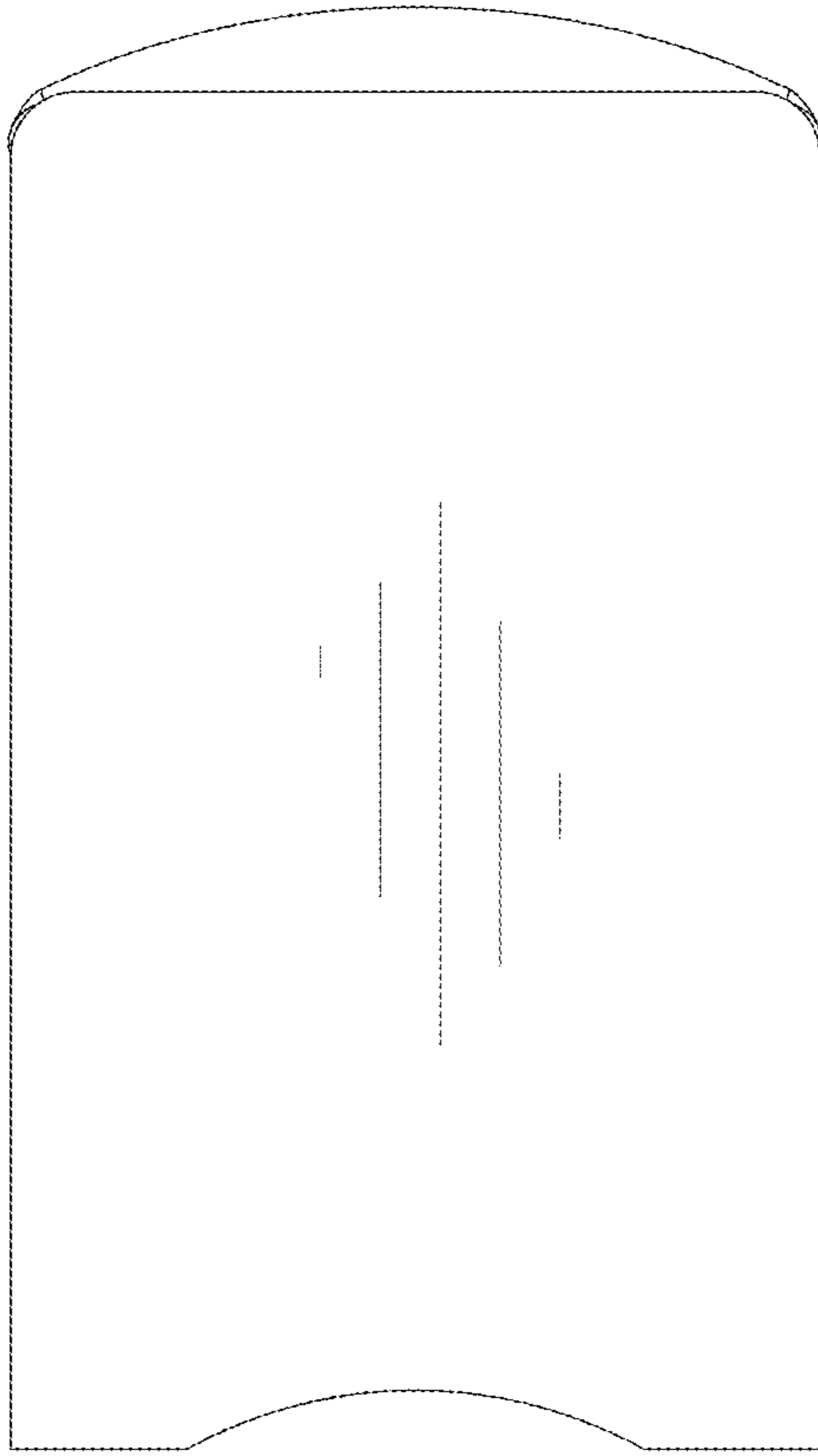

FIG. 6

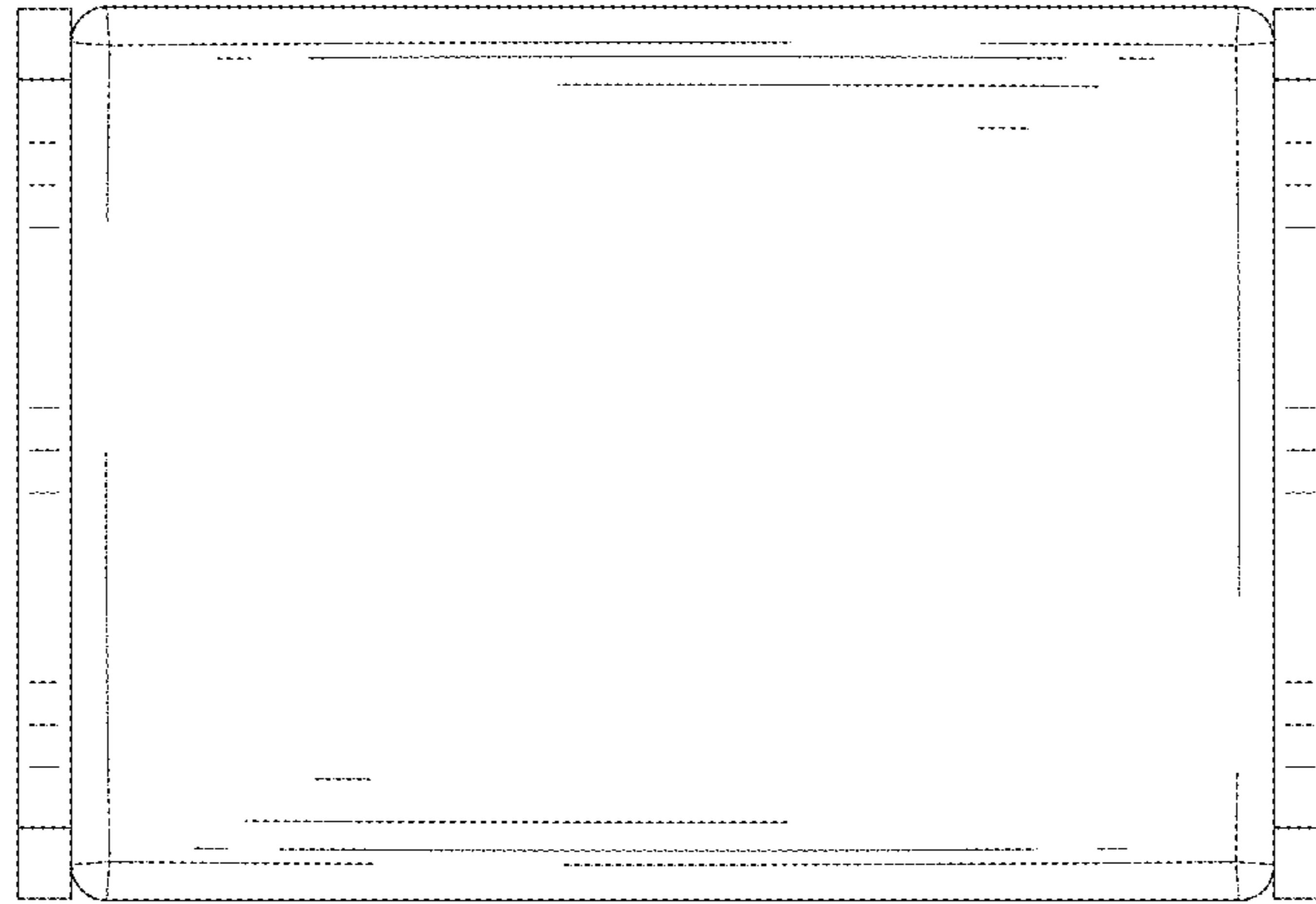

FIG. 7

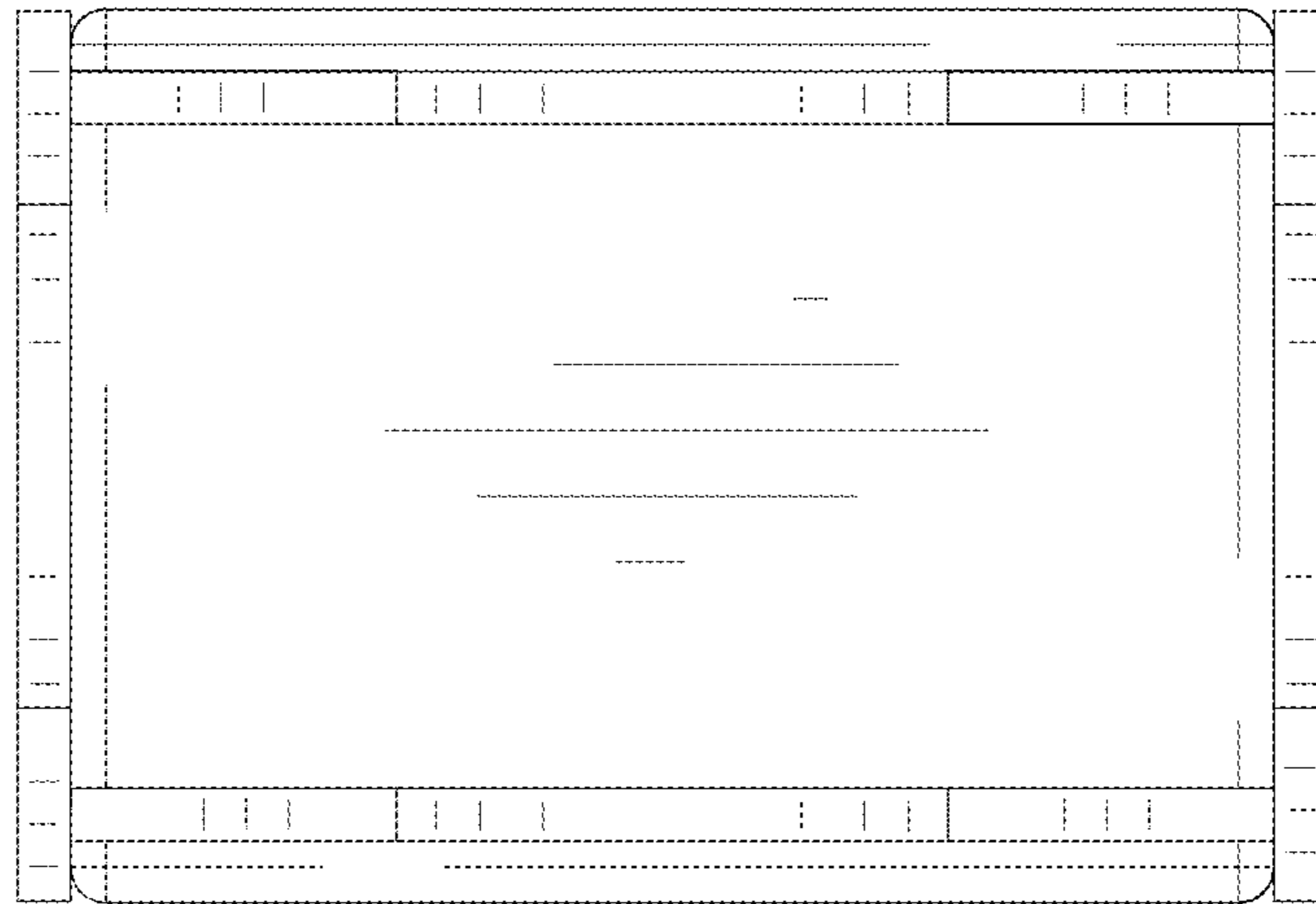

FIG. 8

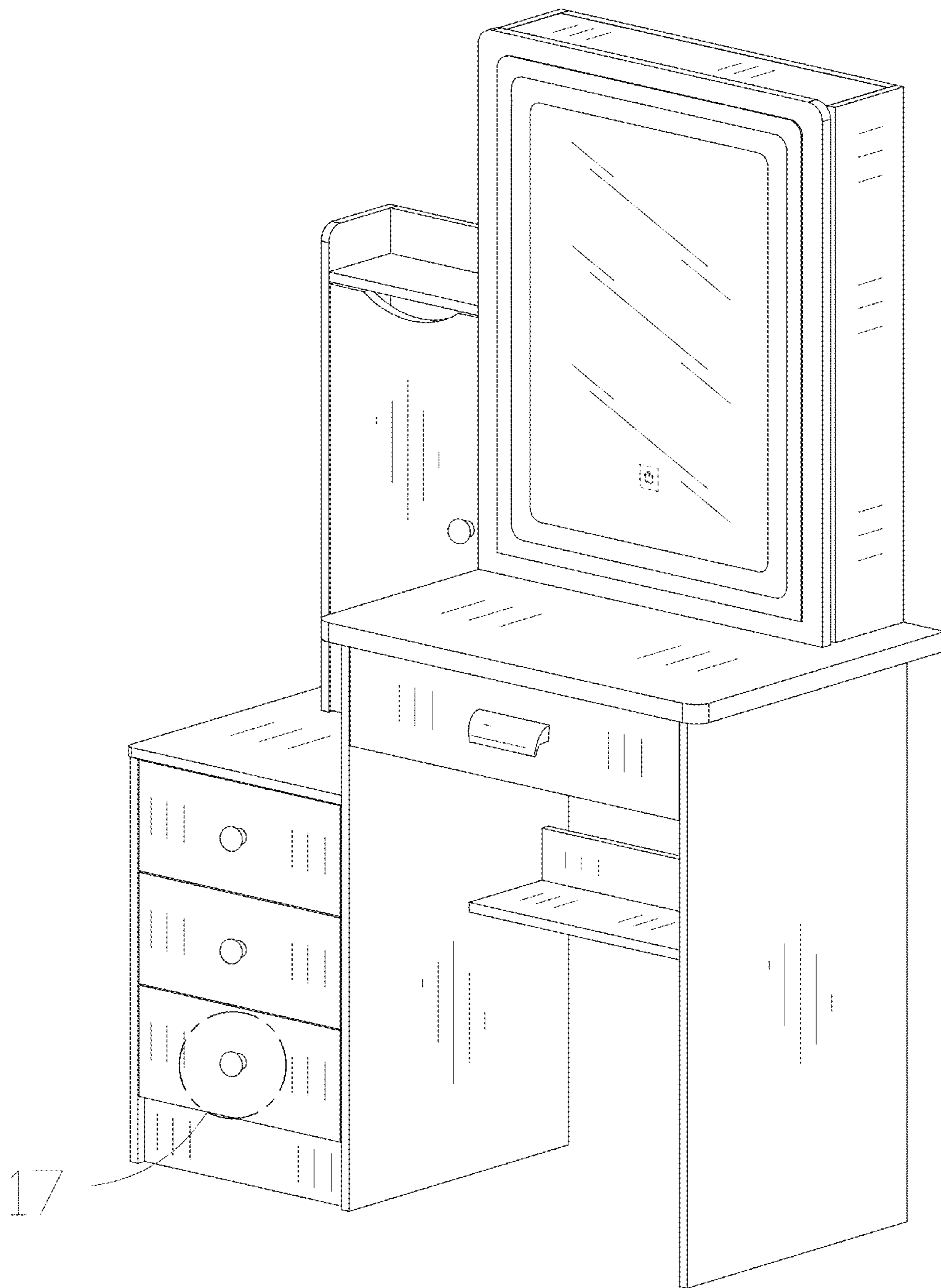

FIG. 9

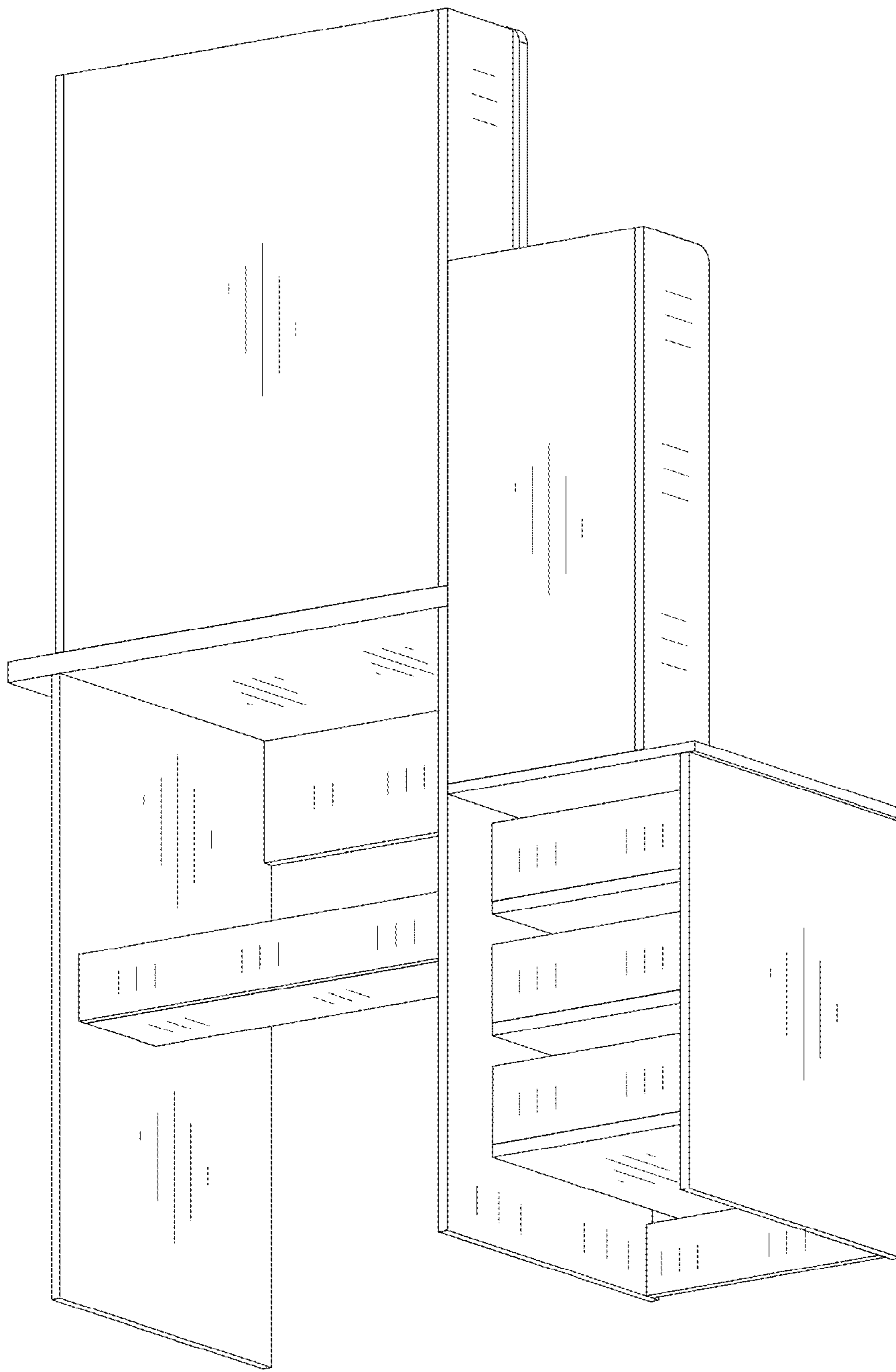

FIG. 10

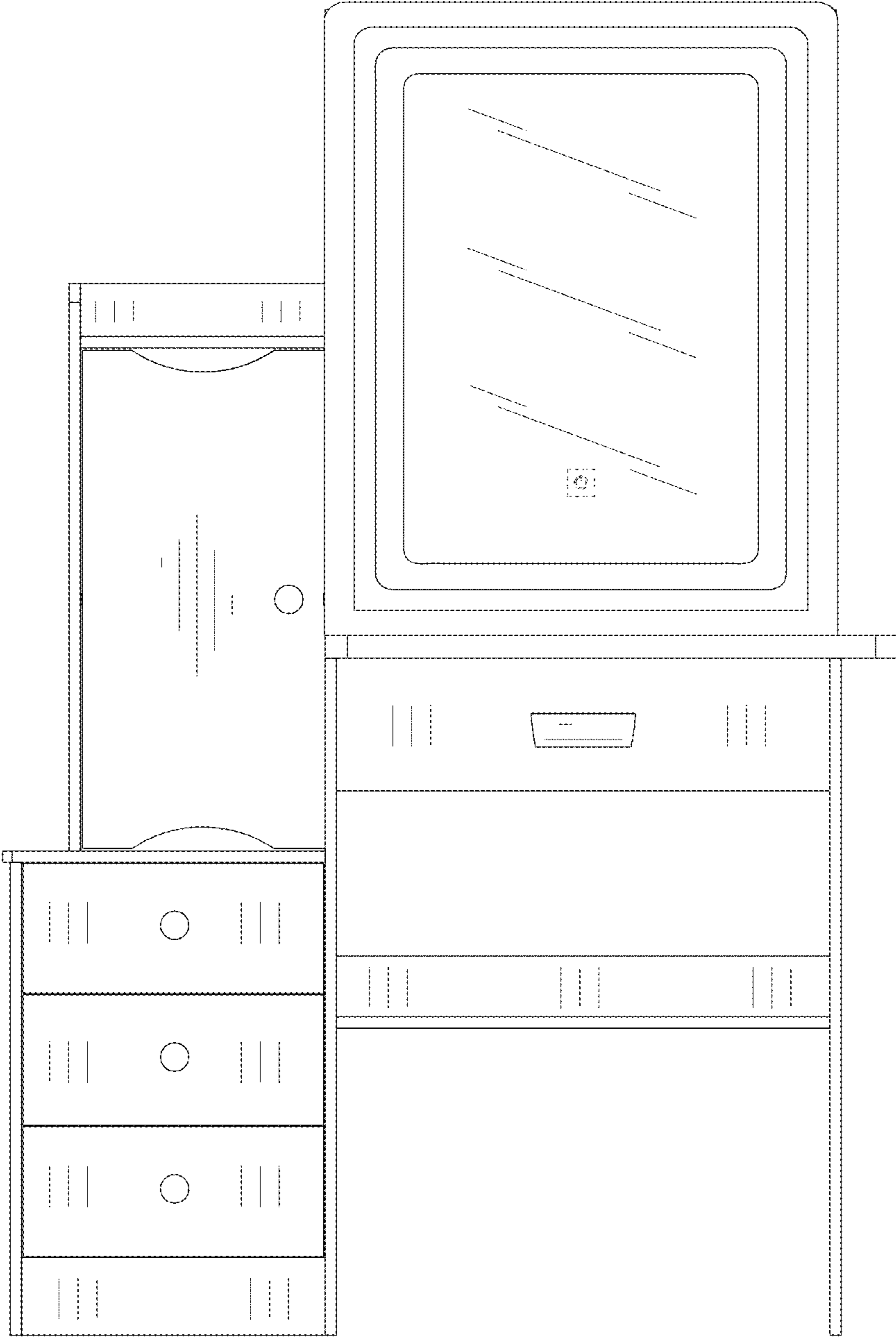

FIG. 11

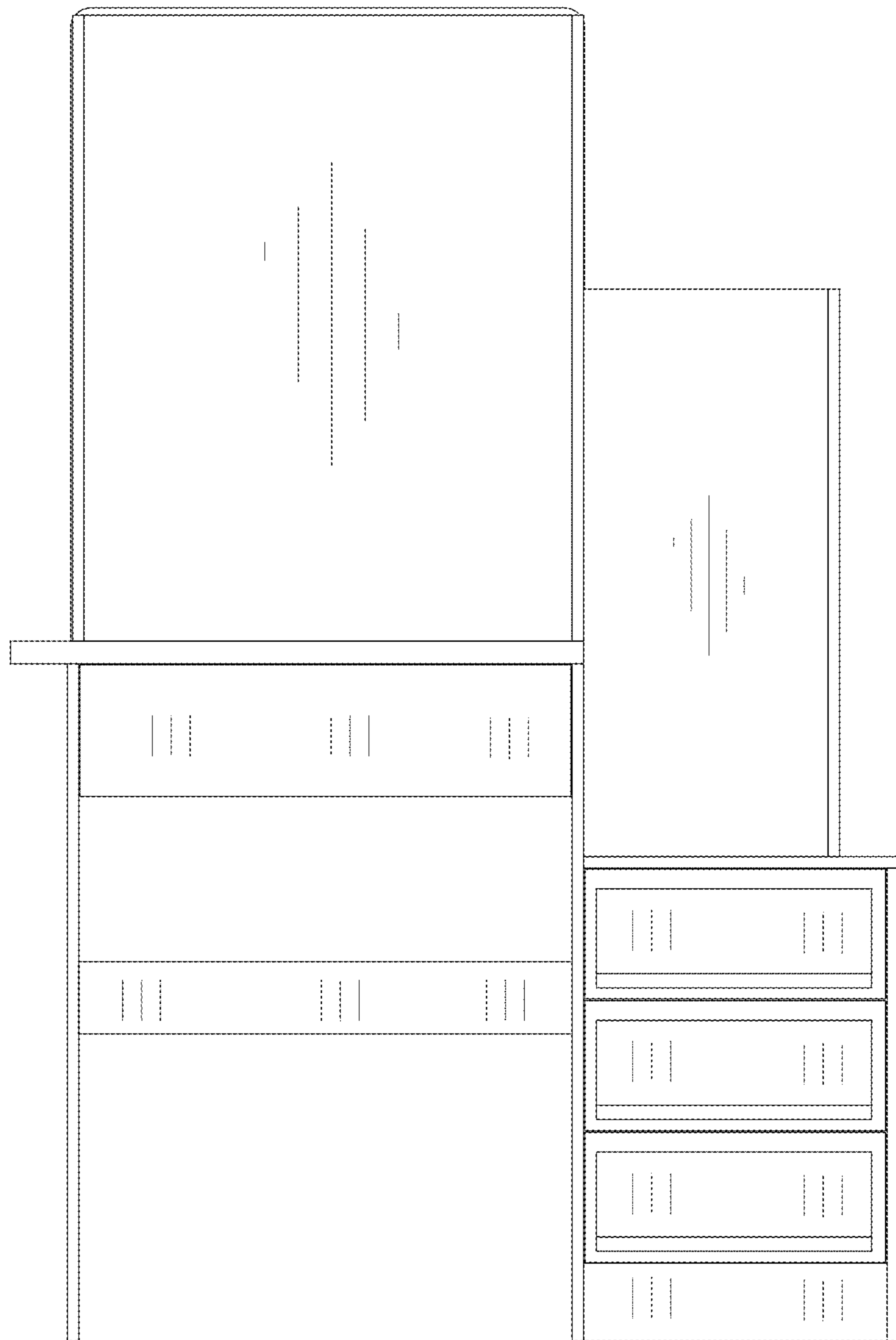

FIG. 12

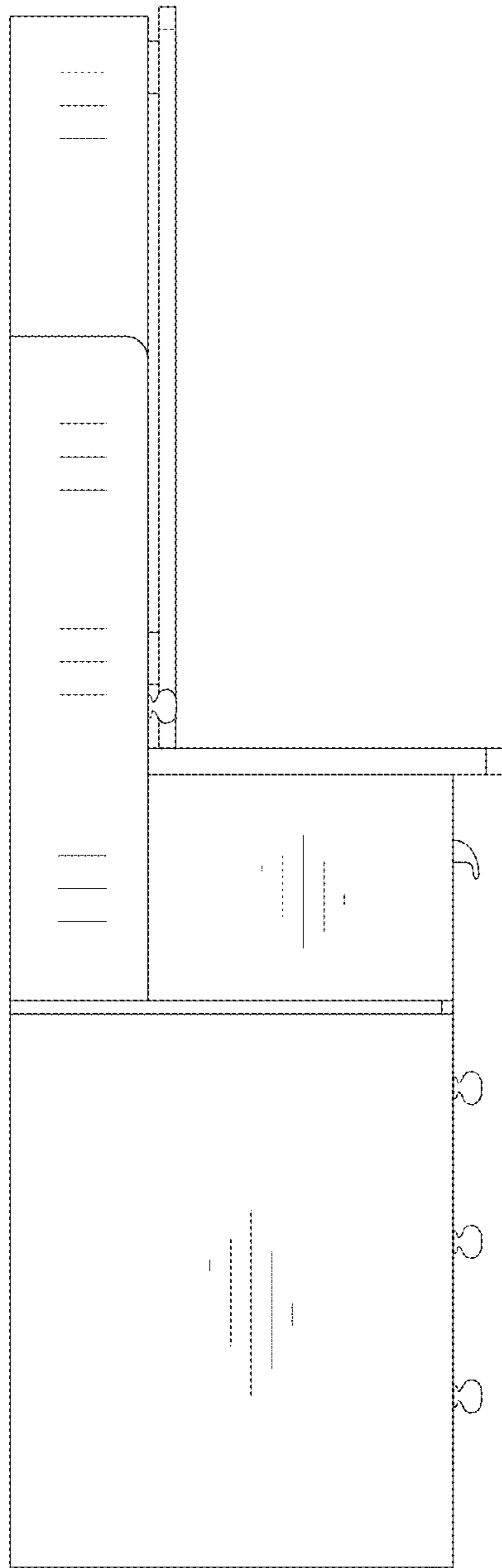

FIG. 13

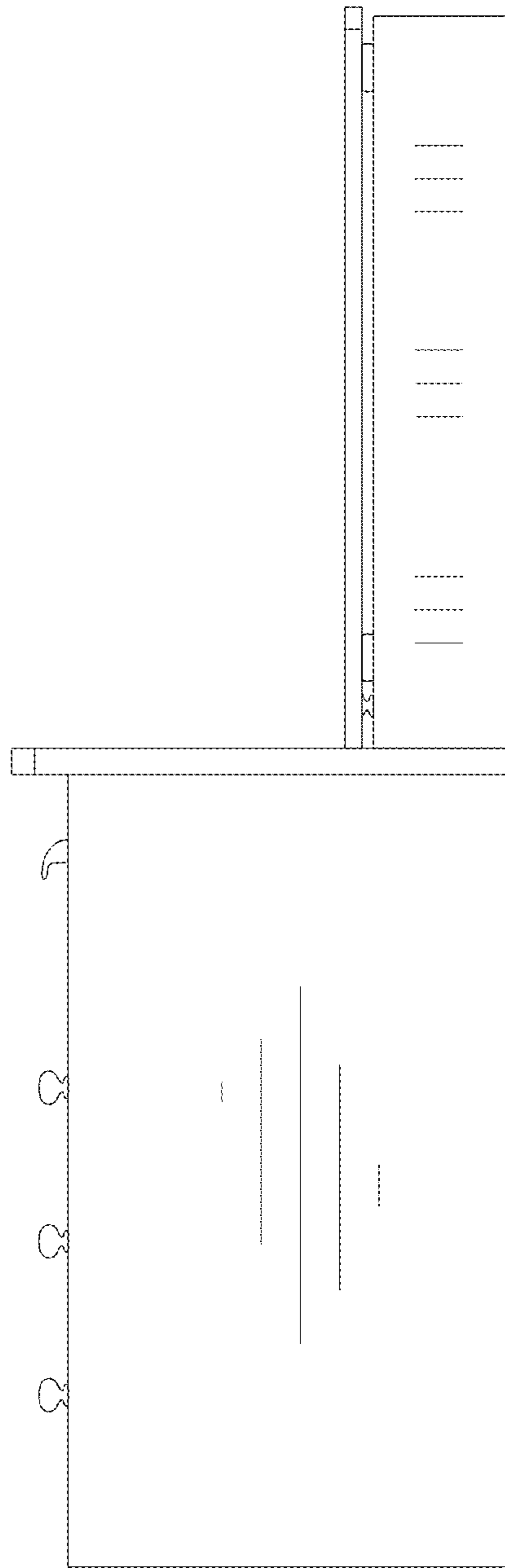

FIG. 14

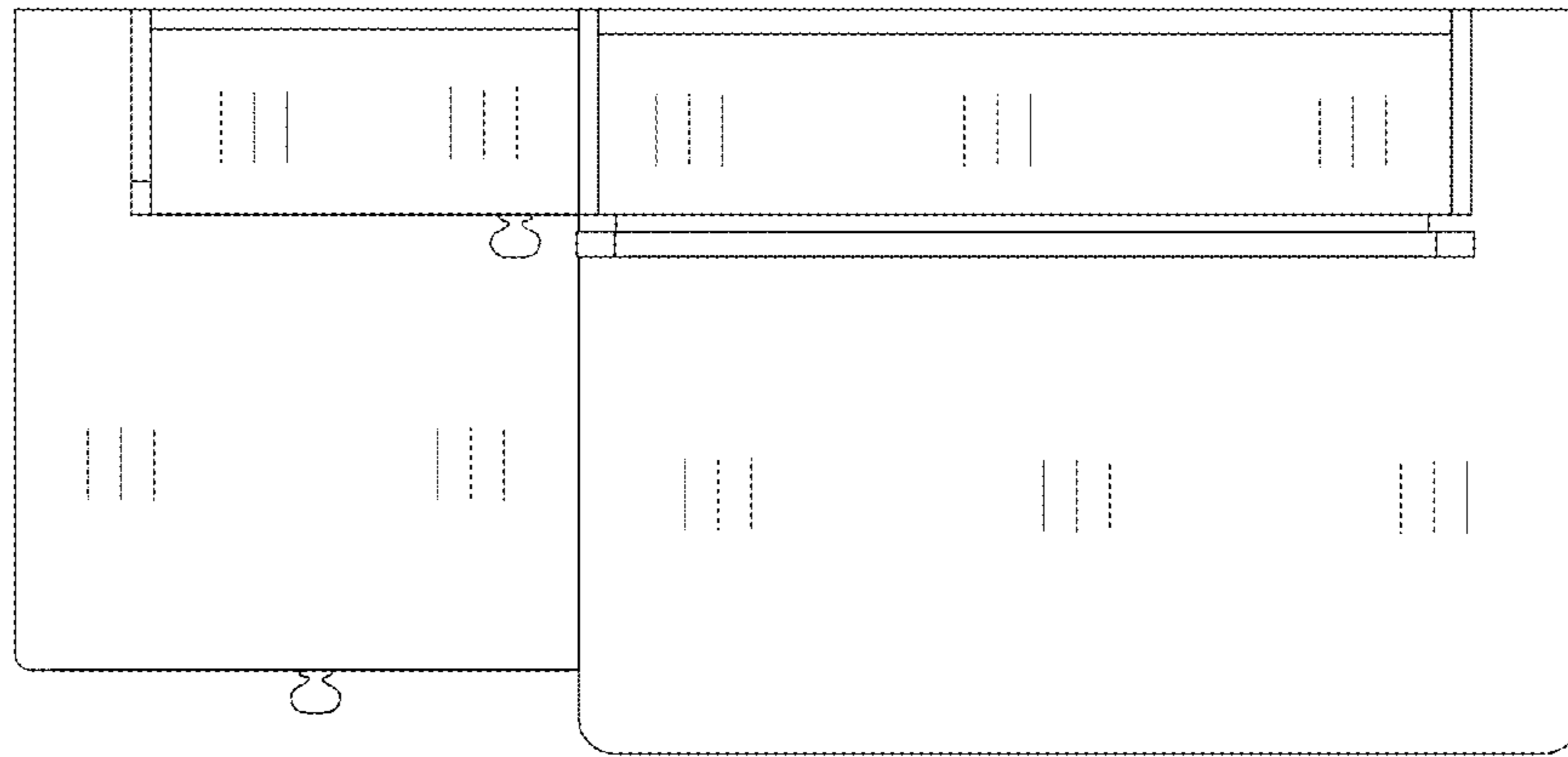

FIG. 15

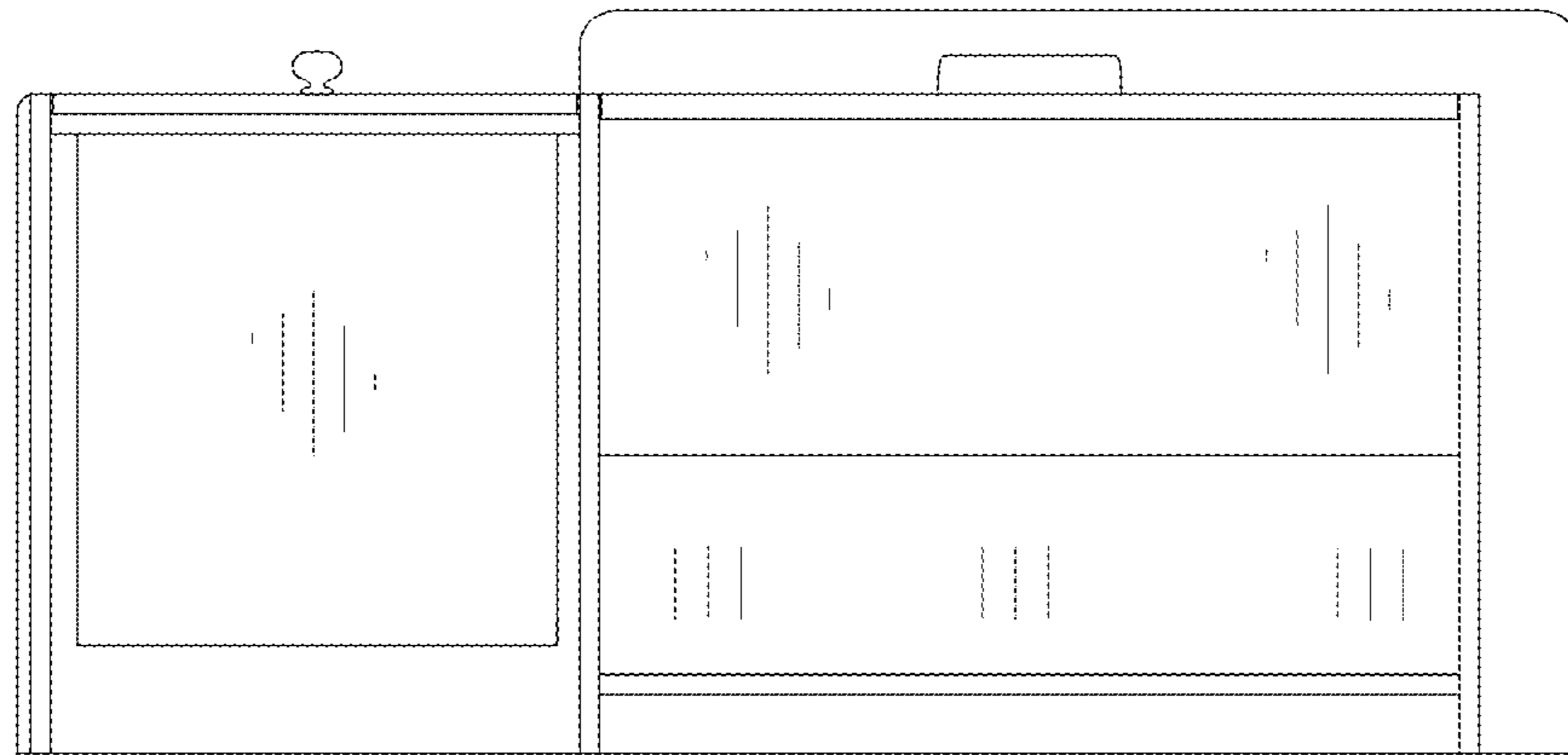

FIG. 16



FIG. 17

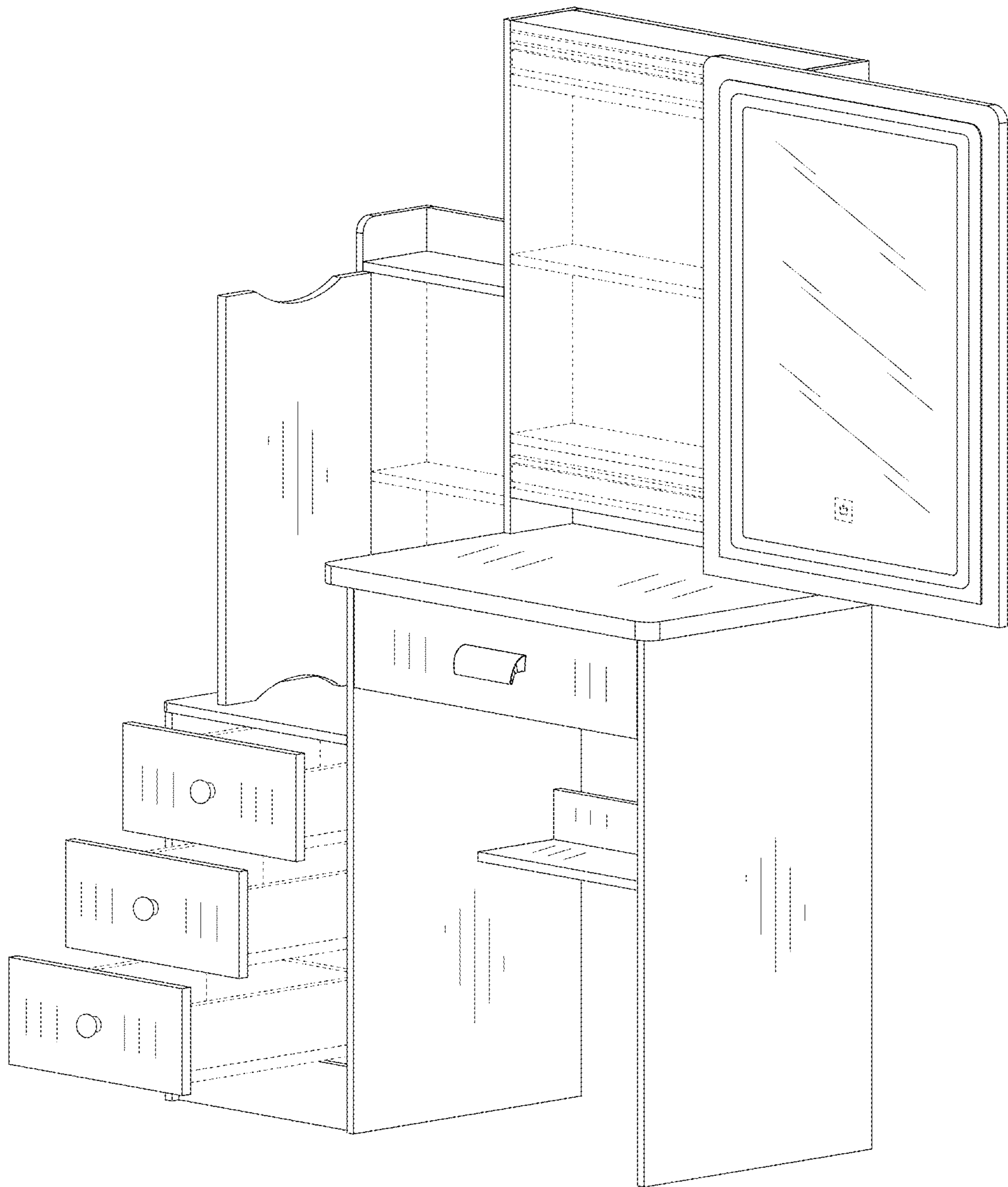

FIG. 18