



US00D971645S

(12) **United States Design Patent** (10) **Patent No.:** **US D971,645 S**
Zukof (45) **Date of Patent:** **** Dec. 6, 2022**

(54) **SEAT CUSHION**

(74) *Attorney, Agent, or Firm* — Greenberg Traurig, LLP

(71) Applicant: **Get Cushy LLC**, Miami, FL (US)

(57) **CLAIM**

(72) Inventor: **Julie Zukof**, Miami, FL (US)

The ornamental design for a seat cushion, as shown and described.

(73) Assignee: **Get Cushy LLC**, Miami, FL (US)

(**) Term: **15 Years**

DESCRIPTION

(21) Appl. No.: **29/758,628**

(22) Filed: **Nov. 17, 2020**

(51) **LOC (13) Cl.** **06-13**

(52) **U.S. Cl.**
USPC **D6/611**

(58) **Field of Classification Search**
USPC D6/610–612; D7/402; D12/221
CPC A47C 31/10; A47C 31/11; A47C 7/386;
A47J 37/0786; B60N 2/60; B60N 2/6018
See application file for complete search history.

FIG. 1. is a front perspective view of a seat cushion;
FIG. 2. is back perspective view of the seat cushion of FIG. 1;
FIG. 3. is an elevated front view of the seat cushion of FIG. 1;
FIG. 4. is an elevated back view of the seat cushion of FIG. 1;
FIG. 5. is an elevated left side view of the seat cushion of FIG. 1;
FIG. 6. is an elevated right side view of the seat cushion of FIG. 1;
FIG. 7. is a top plan view of the seat cushion of FIG. 1;
FIG. 8. is a bottom plan view of the seat cushion of FIG. 1;
FIG. 9. is a perspective view of the seat cushion of FIG. 1 rolled up;
FIG. 10. is an elevated front view of the seat cushion of FIG. 9;
FIG. 11. is an elevated back view of the seat cushion of FIG. 9;
FIG. 12. is an elevated left side view of the seat cushion of FIG. 9;
FIG. 13. is an elevated right side view of the seat cushion of FIG. 9;
FIG. 14. is a top plan view of the seat cushion of FIG. 9; and,
FIG. 15. is a bottom plan view of the seat cushion of FIG. 9.

(56) **References Cited**

U.S. PATENT DOCUMENTS

2,554,344	A *	5/1951	Pattison	D06F 83/00
					D32/66
D596,439	S *	7/2009	Hall	D6/596
D616,239	S *	5/2010	Sawyer	D6/610
D620,741	S *	8/2010	Pride-Darrington	D6/608
D674,230	S *	1/2013	Berghoff	D6/608
D714,575	S *	10/2014	Mah	D6/608
9,332,858	B1 *	5/2016	Chiang	A47C 7/62
D759,993	S *	6/2016	Stinson	D6/610
D766,018	S *	9/2016	Coward	D6/608
D793,125	S *	8/2017	Bemis	D6/611
D860,686	S *	9/2019	Lindberg	D6/611
D899,153	S *	10/2020	Provatas	A47C 7/62
					D6/611

(Continued)

Primary Examiner — Kevin K Rudzinski
Assistant Examiner — Clare Ann Gannon

The broken lines in the drawings depict portions of the seat cushion that form no part of the claimed design. The shade lines in the figures show contour and not surface ornamentation.

1 Claim, 9 Drawing Sheets

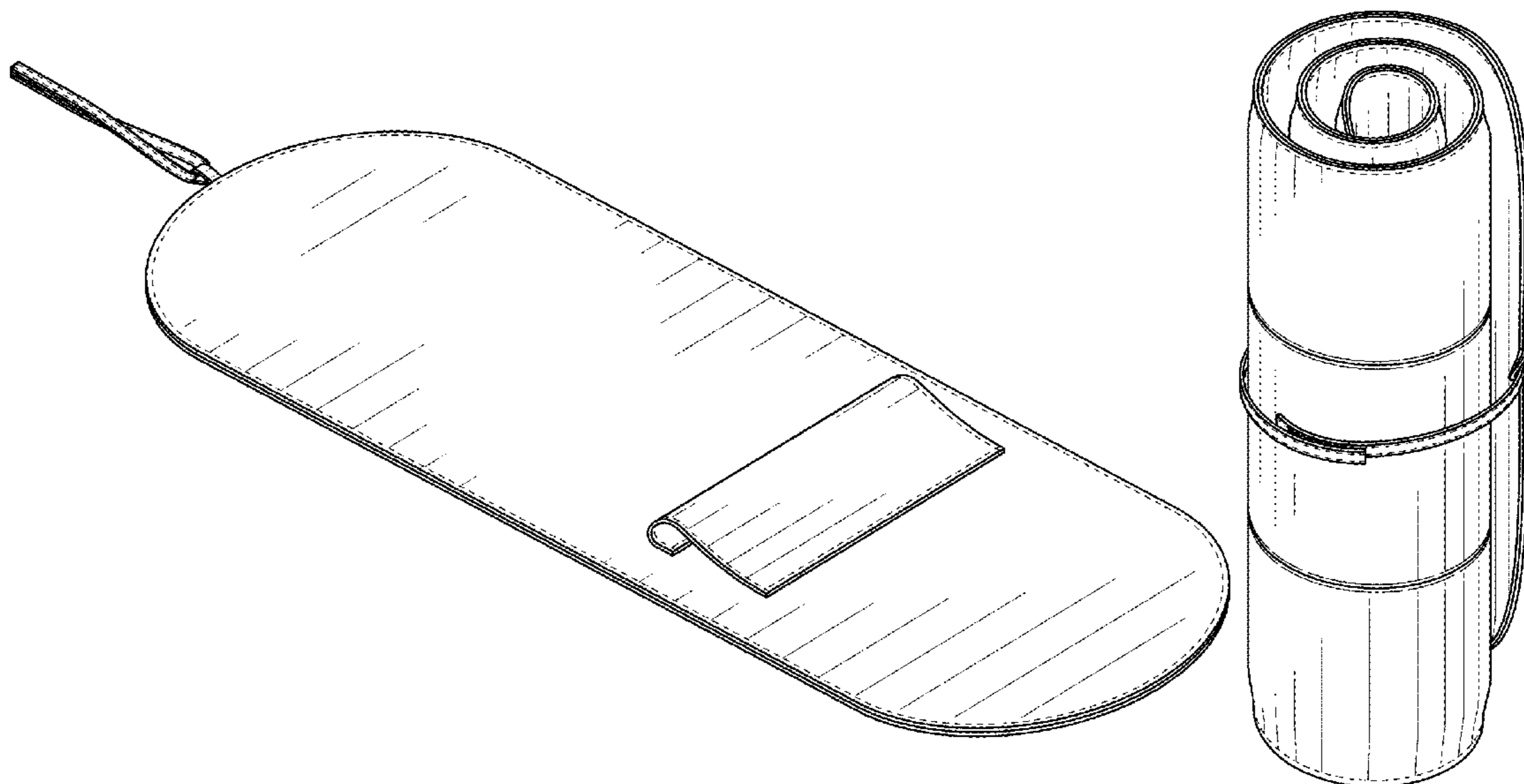

(56)

References Cited

U.S. PATENT DOCUMENTS

D946,934 S * 3/2022 Beamen D06F 83/00
D6/608

* cited by examiner

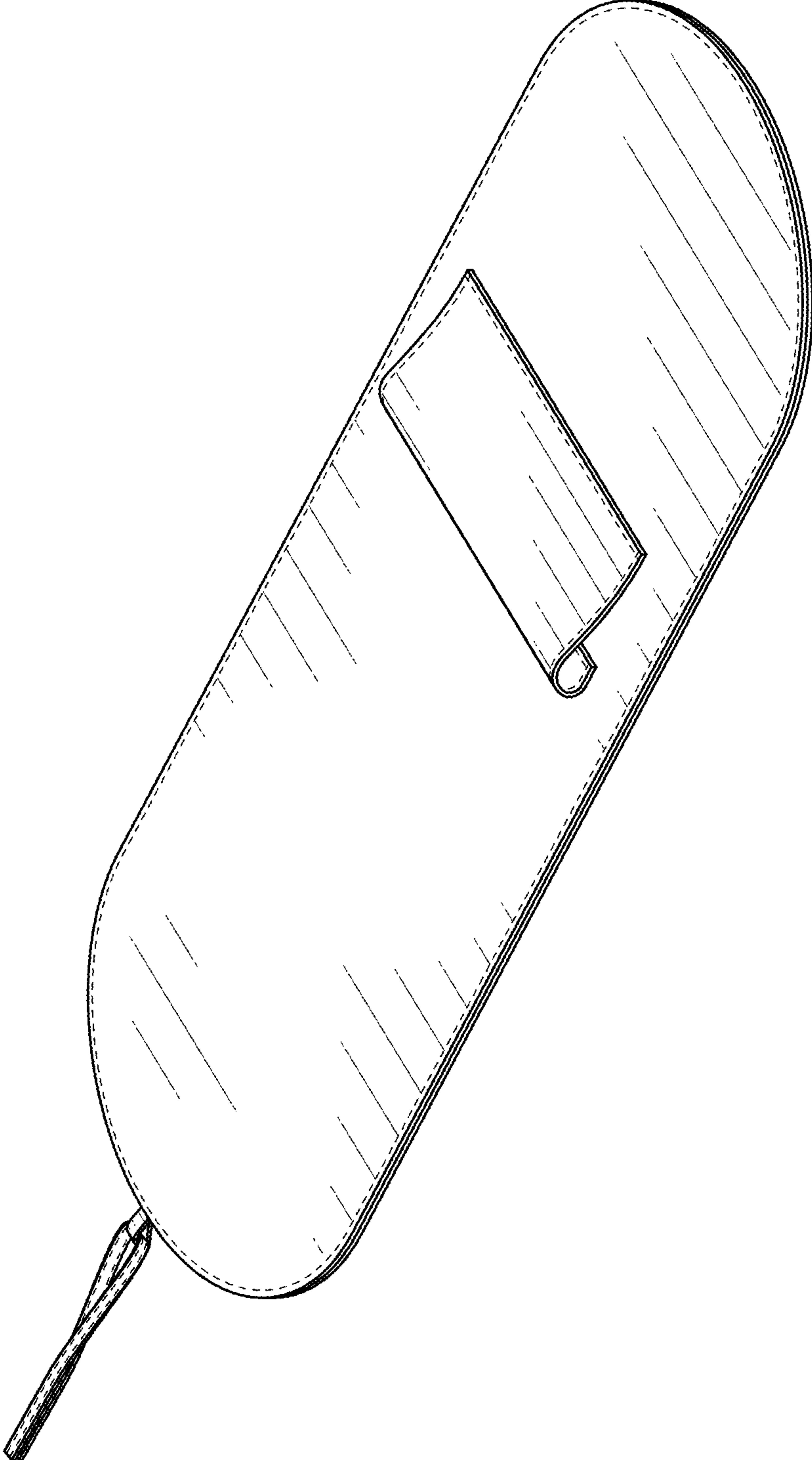

FIG. 1

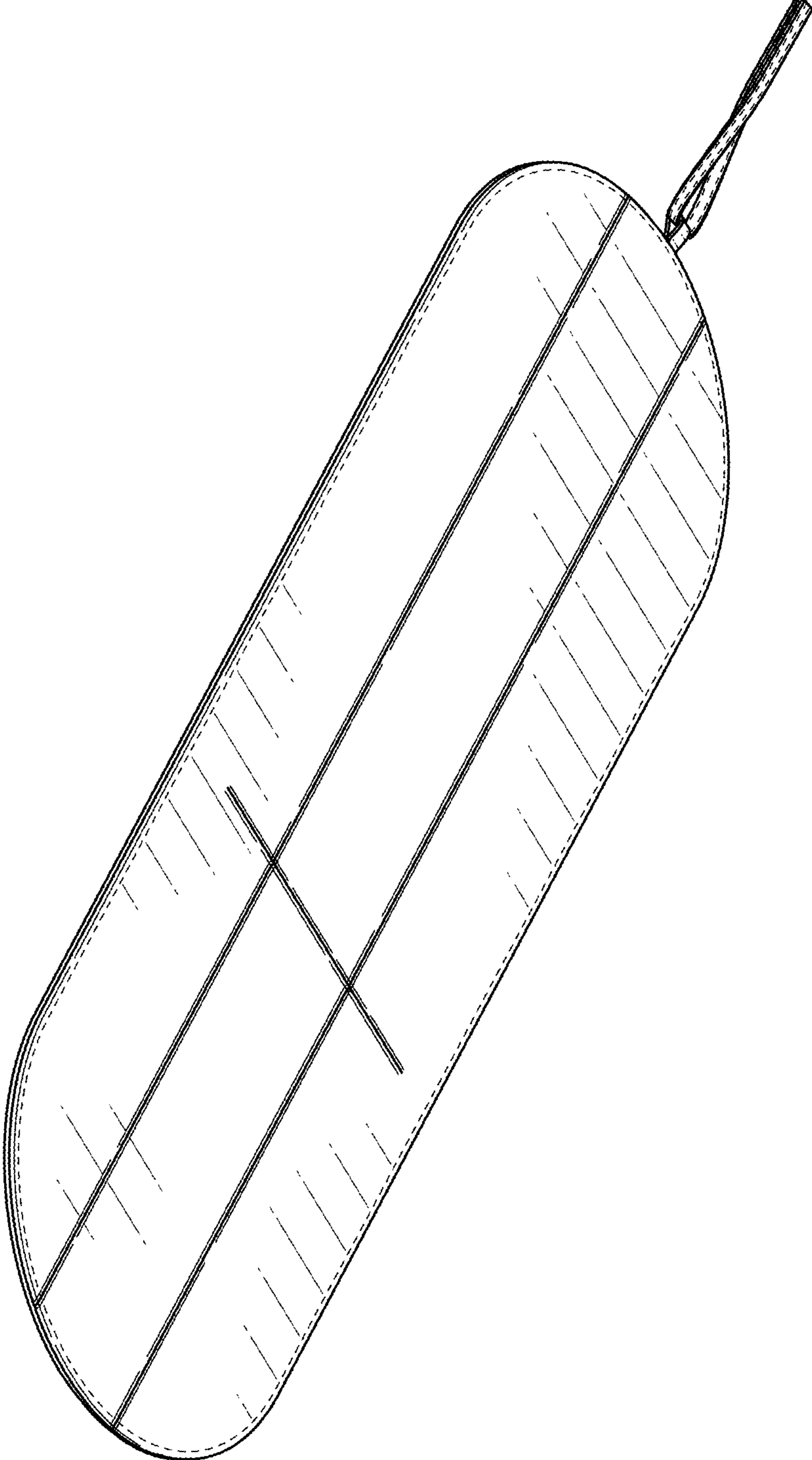

FIG. 2

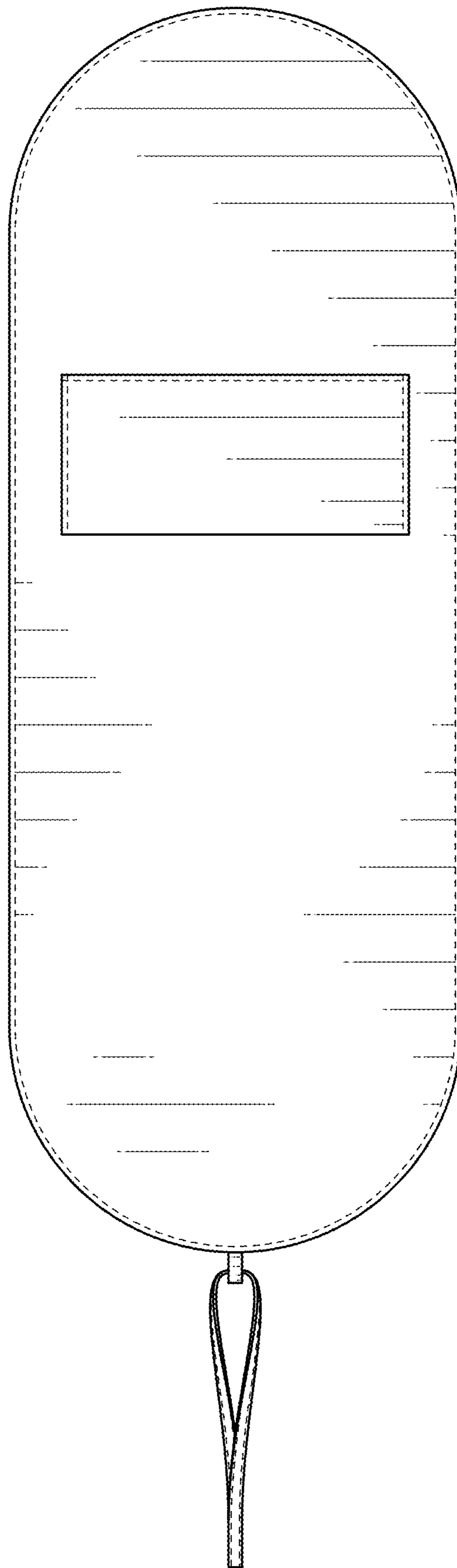

FIG. 3

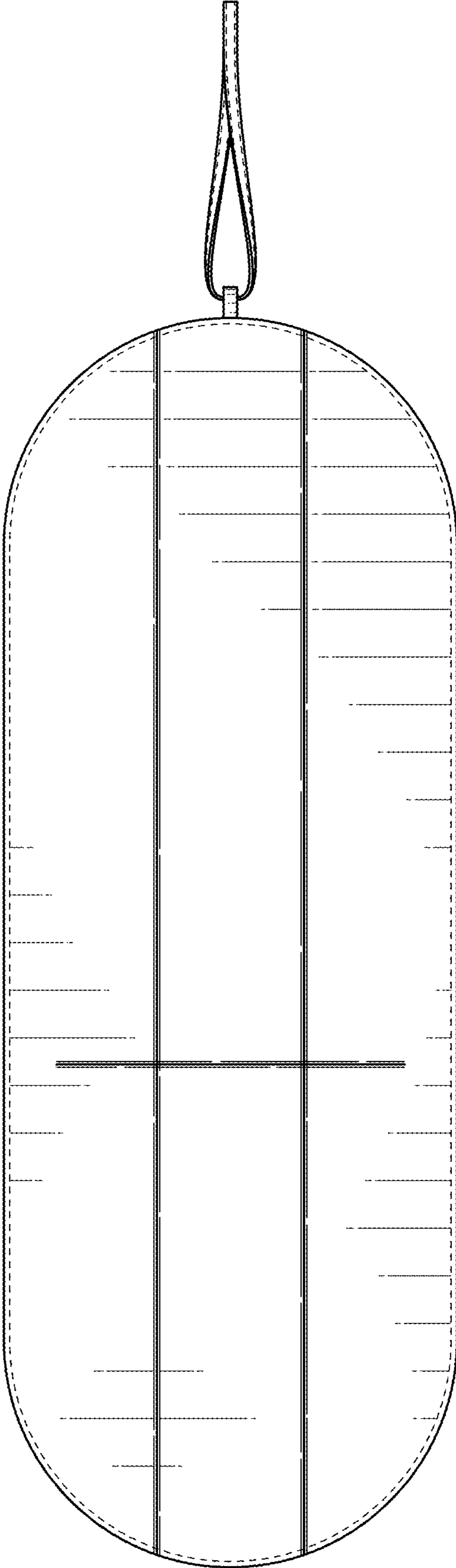

FIG. 4



FIG. 5

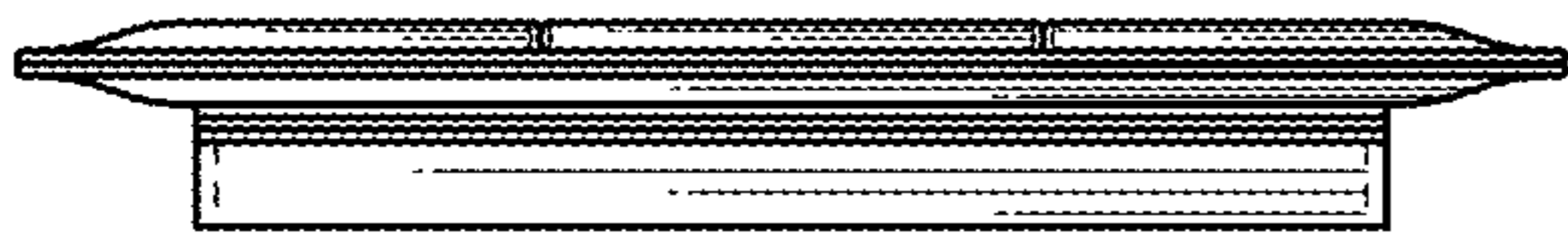

FIG. 6

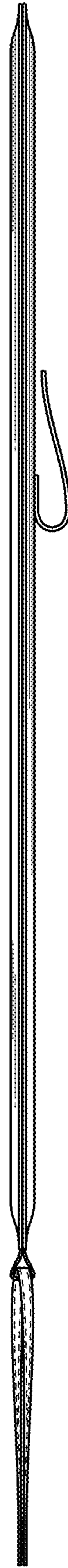

FIG. 7



FIG. 8

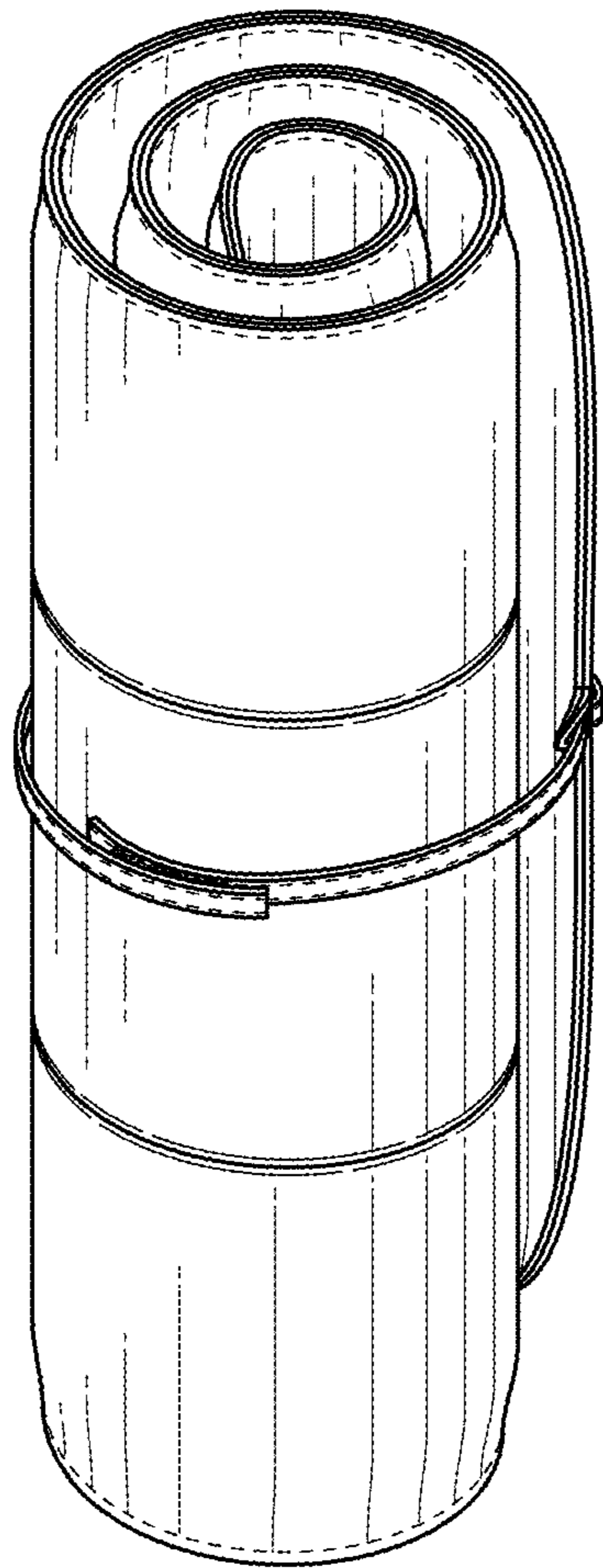

FIG. 9

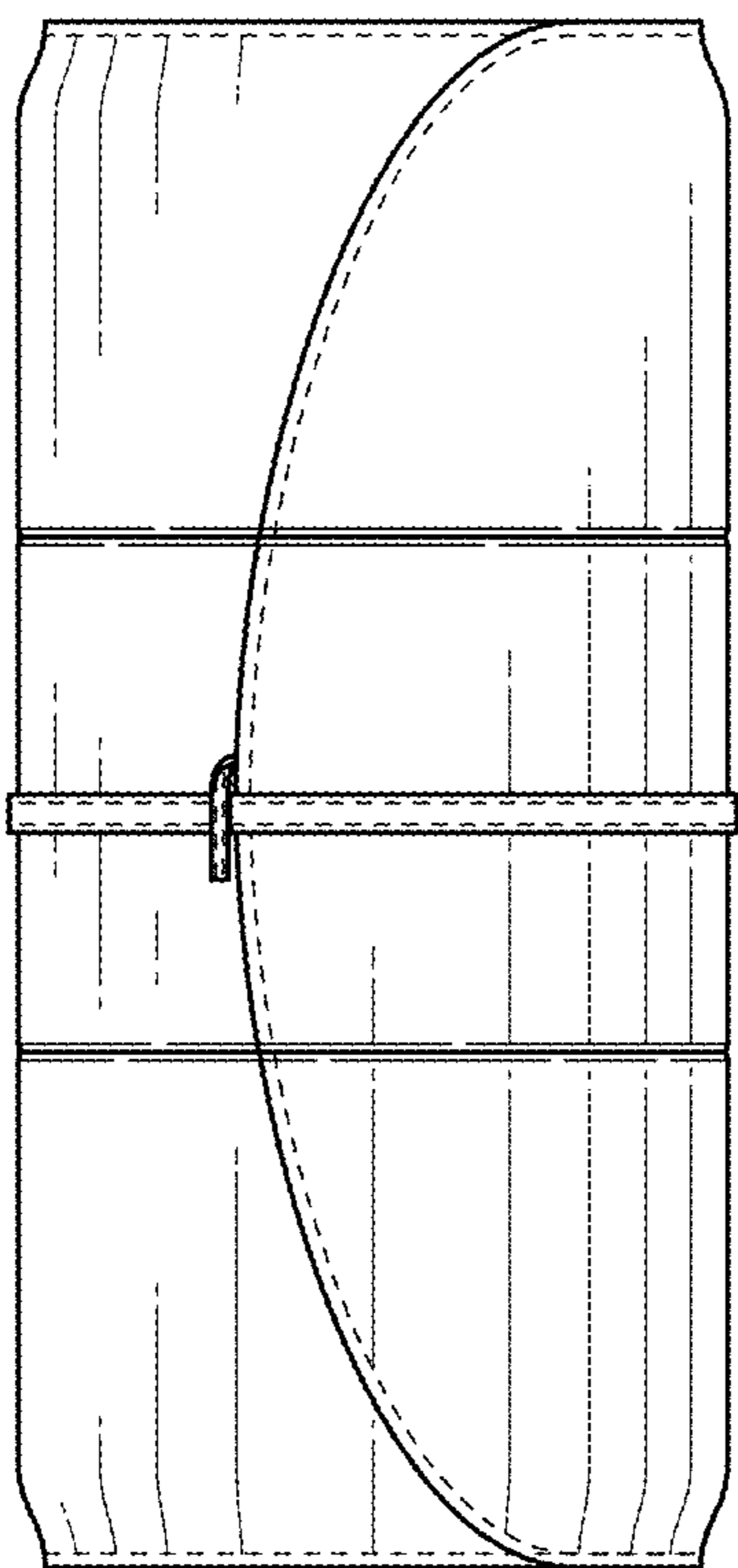

FIG. 10

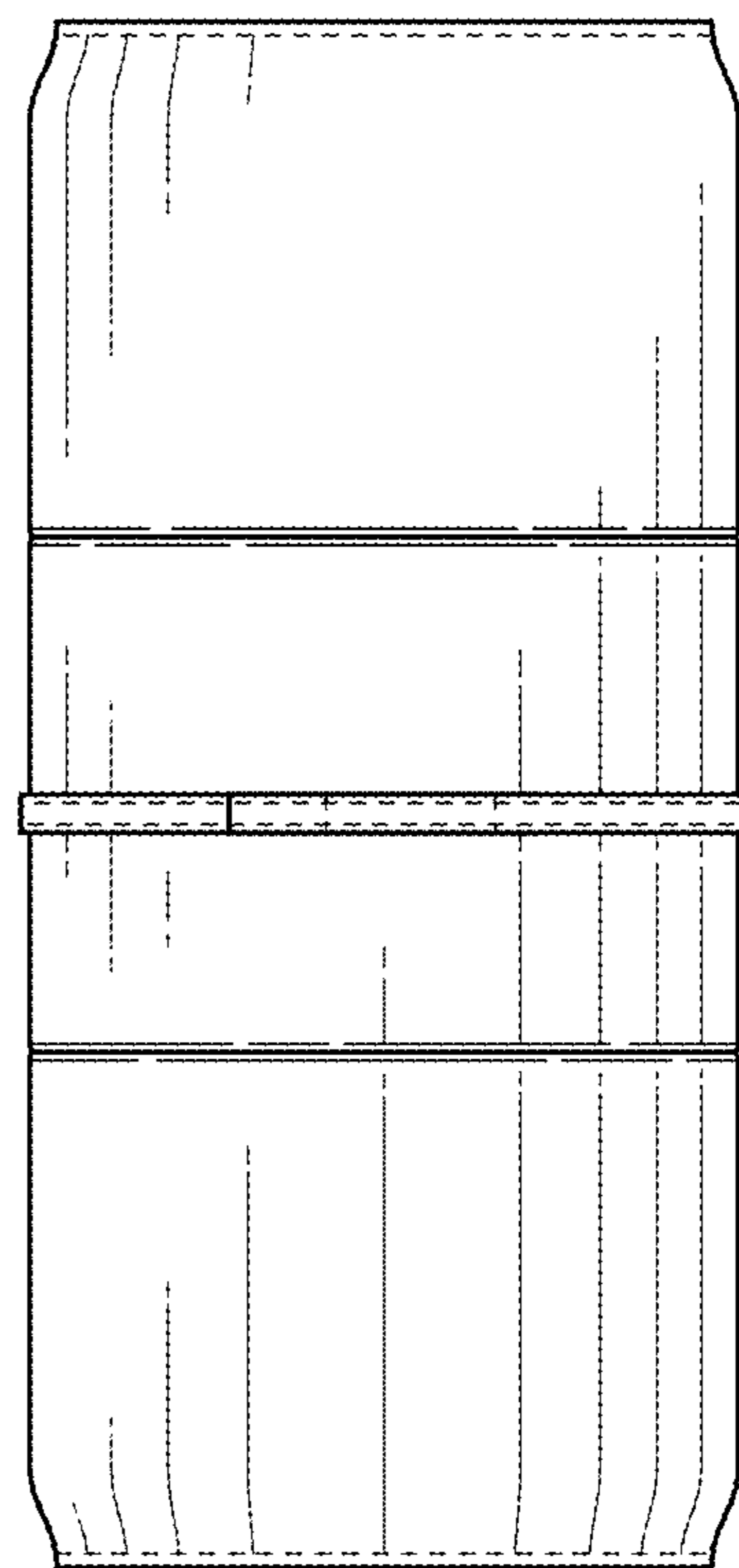

FIG. 11

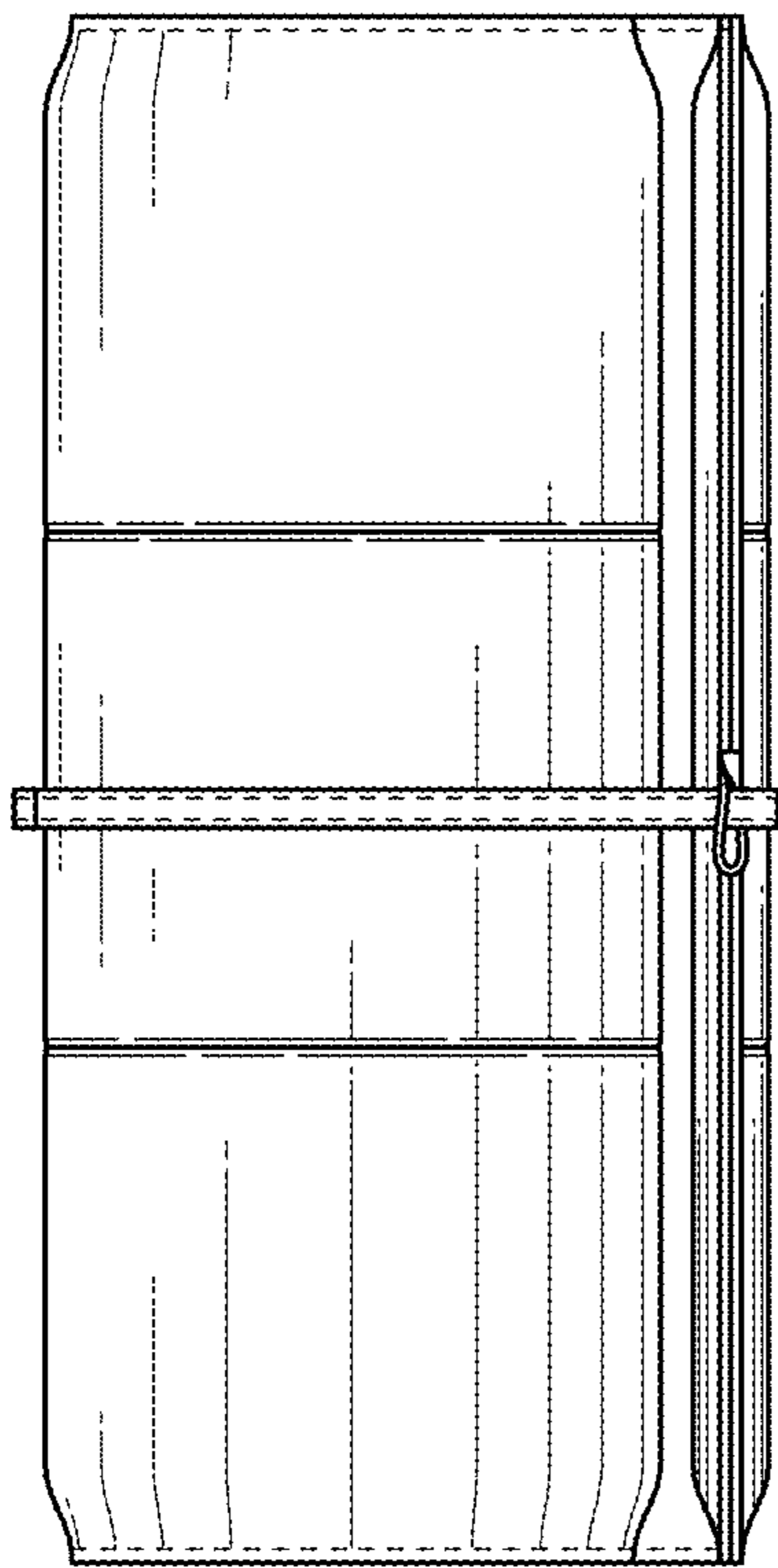

FIG. 12

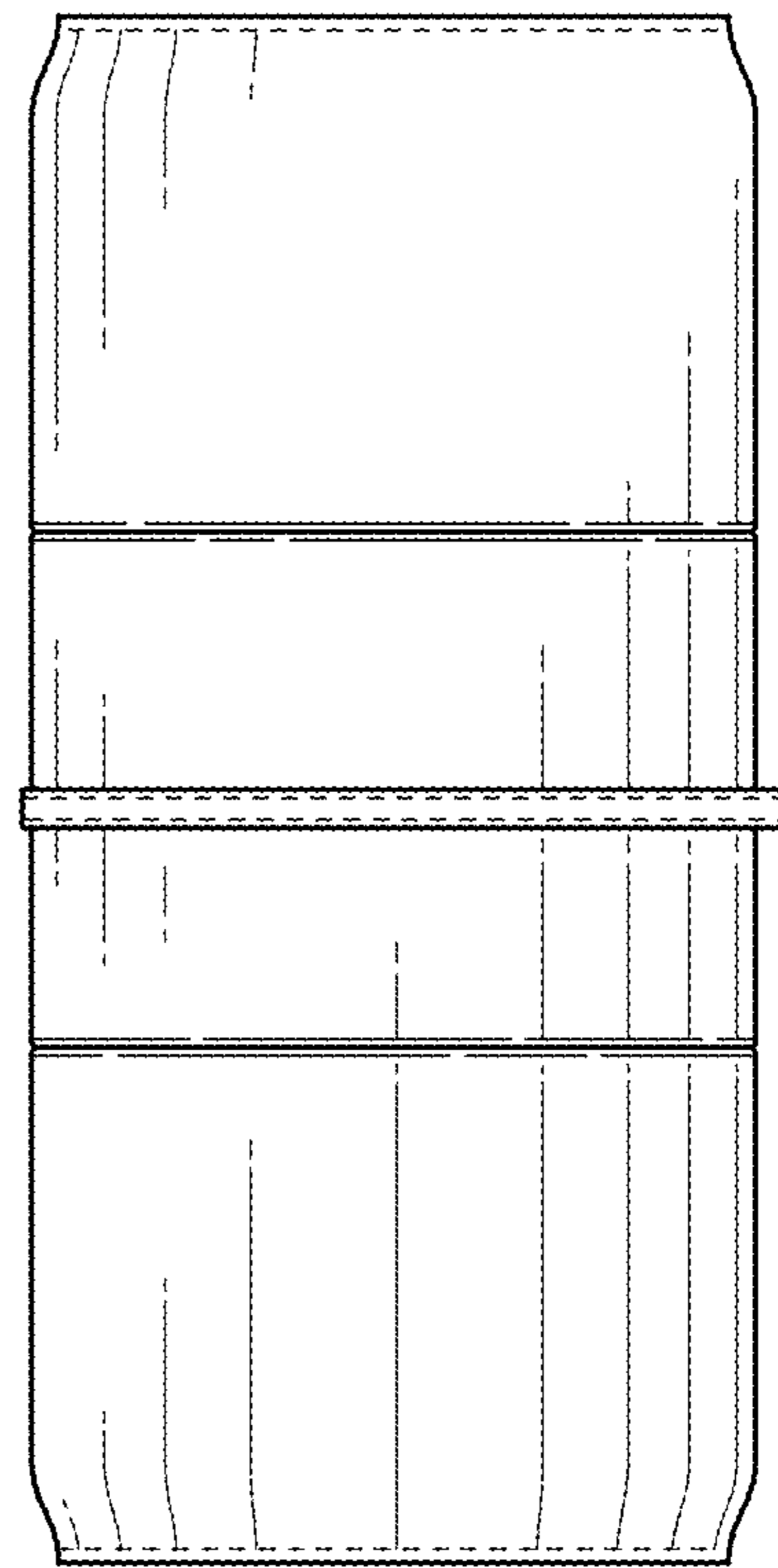

FIG. 13

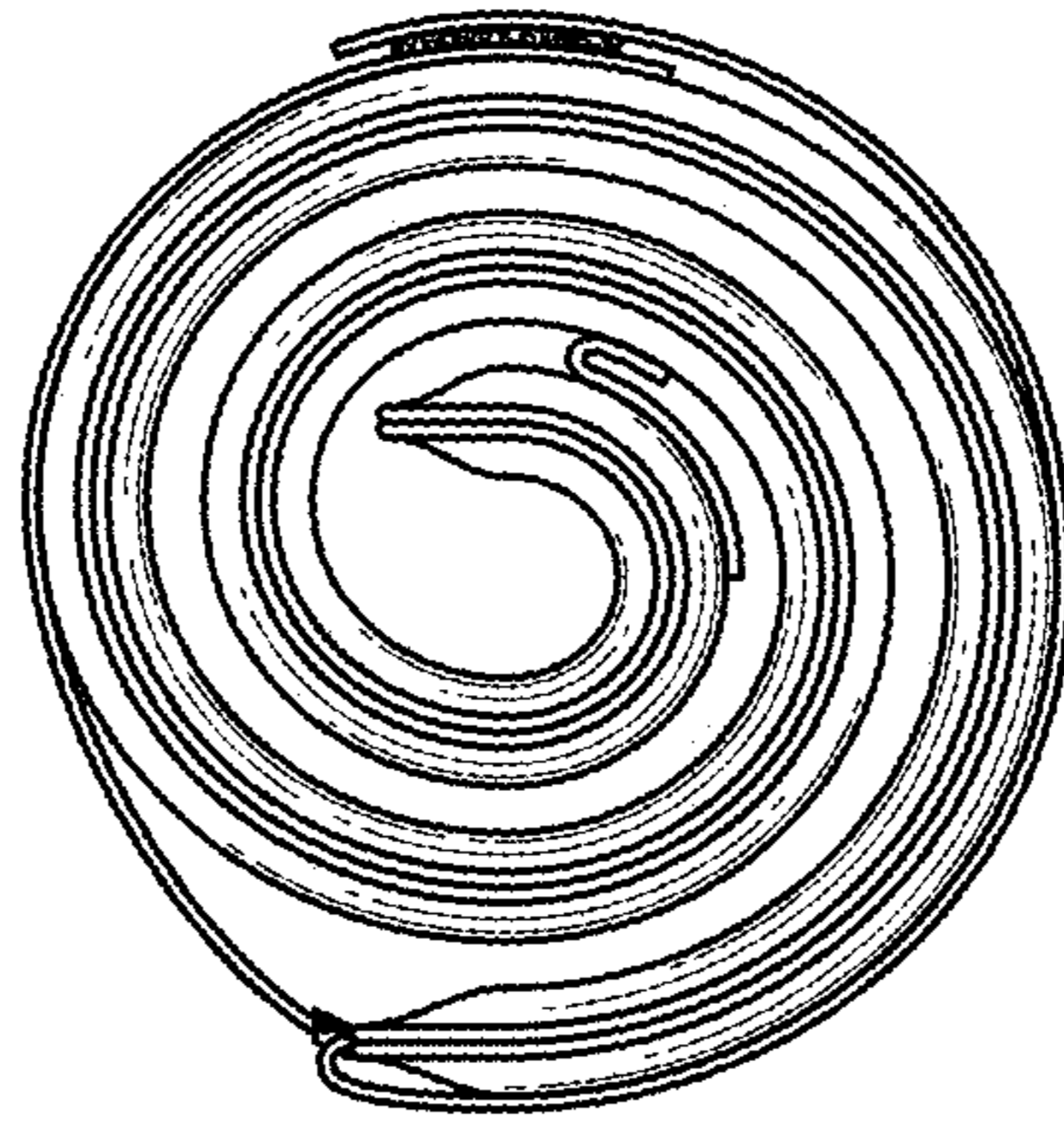

FIG. 14

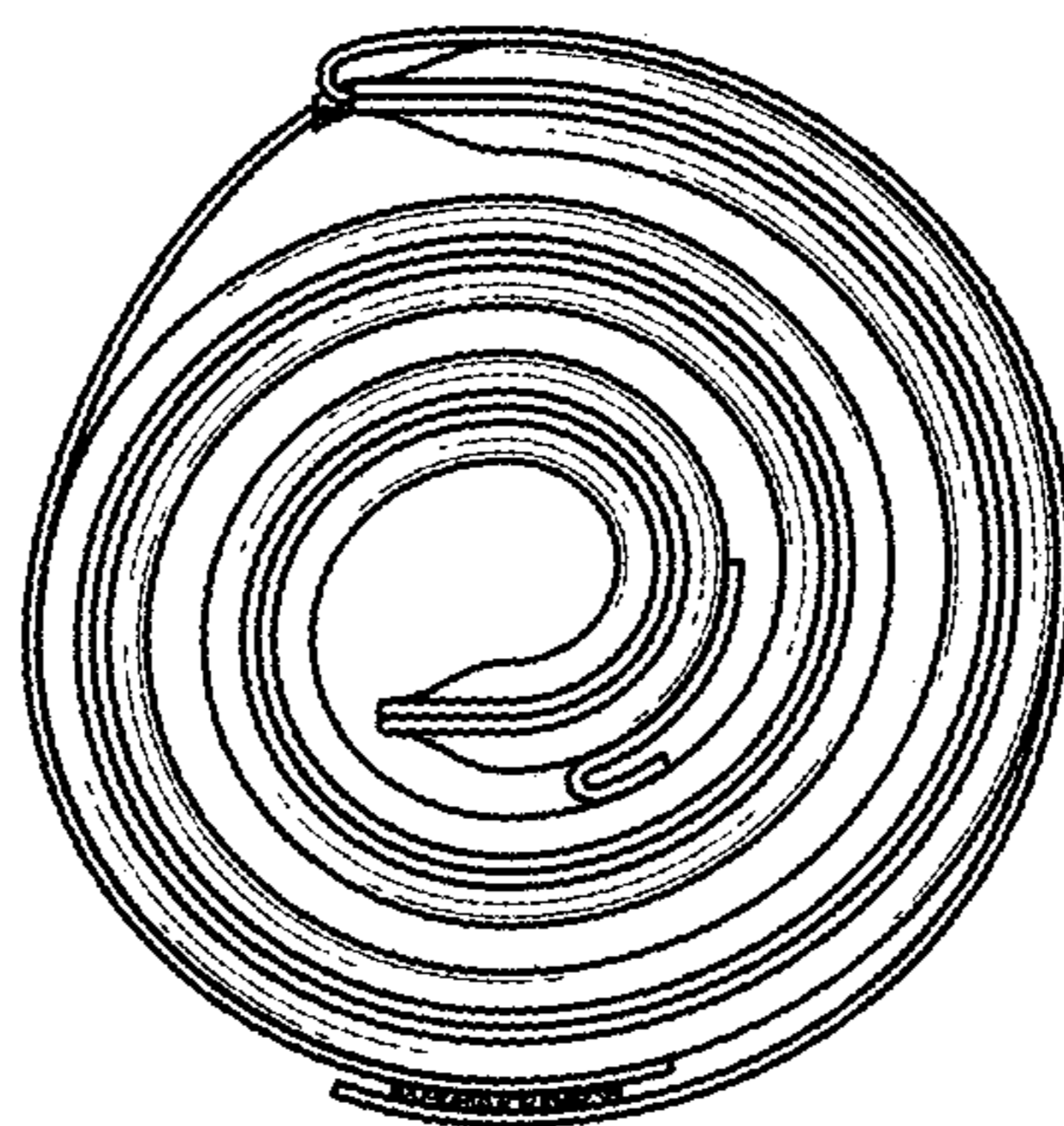

FIG. 15