



US00D971607S

(12) **United States Design Patent** (10) **Patent No.:** **US D971,607 S**  
**Zhang** (45) **Date of Patent:** **\*\* Dec. 6, 2022**

(54) **MAKEUP BRUSH FIXING CONNECTOR**

(71) Applicant: **Shenzhen Tianyuji Technology Co., Ltd.**, Guangdong (CN)

(72) Inventor: **Bo Zhang**, Guangdong (CN)

(73) Assignee: **Shenzhen Tianyuji Technology Co., Ltd.**, Guangdong (CN)

(\*\*) Term: **15 Years**

(21) Appl. No.: **29/750,173**

(22) Filed: **Sep. 11, 2020**

(51) **LOC (13) Cl.** ..... **28-03**

(52) **U.S. Cl.**  
USPC ..... **D4/100; D32/35**

(58) **Field of Classification Search**  
USPC ..... D4/100, 102, 114, 115, 116, 117, 118, D4/119, 120, 121, 122, 127, 128, 129, D4/130, 132, 133, 134, 135, 136, 137, D4/138, 199; D28/7; D8/382; D32/35  
CPC . A46B 9/021; A46B 9/023; A46B 2200/1046; A46B 7/04; A61B 17/162  
See application file for complete search history.

(56) **References Cited**

**U.S. PATENT DOCUMENTS**

D192,039	S	*	1/1962	Jones	.....	D7/669
D427,216	S	*	6/2000	Miles	.....	D15/140
D507,115	S	*	7/2005	Hay	.....	D4/199
D638,798	S	*	5/2011	De La Rosa	.....	D13/144
D675,829	S	*	2/2013	Jakubow	.....	D4/138
8,726,916	B2	*	5/2014	Park	.....	A46B 9/021 132/320
D724,245	S	*	3/2015	Clifford	.....	D26/37
D735,549	S	*	8/2015	Schenk	.....	D15/140
D772,579	S	*	11/2016	Baranes	.....	D9/504
D865,505	S	*	11/2019	Brewer	.....	D8/382
D882,272	S	*	4/2020	Celia, Jr.	.....	D28/7
10,881,194	B2	*	1/2021	Machiorlette	.....	G09B 19/24
11,026,493	B2	*	6/2021	Park	.....	A46B 13/02
D930,987	S	*	9/2021	Zeng	.....	D4/100
2022/0168067	A1	*	6/2022	Bernasconi	.....	A61C 1/144

**OTHER PUBLICATIONS**

Makeup Brush Cleaner by Shenzhen Tianyuji Technology Co. [on-line]. [Original publication date unknown.] [Retrieved from the Internet Jul. 16, 2022.] URL: <https://tiyokii.en.alibaba.com/product/1600069194264-819648474/2020\_new\_Makeup\_Brush\_Cleaner\_Dryer\_Wash\_and\_Dry\_Seconds\_Suitable\_All\_Brushes\_8\_Rubber\_electric\_makeup\_brush\_cleaner\_tool.html?spm=a2700.shop\_index.11406.2.128de9e18ZckTj> (Year: 2022).\*

Video of Makeup Brush Cleaner by Shenzhen Tianyuji Technology Co. [on-line]. [Original publication date unknown.] [Retrieved from the Internet Jul. 16, 2022.] URL: <https://tiyokii.en.alibaba.com/product/1600069194264-819648474/2020\_new\_Makeup\_Brush\_Cleaner\_Dryer\_Wash\_and\_Dry\_Seconds\_Suitable\_All\_Brushes\_8\_Rubber\_electric\_makeup\_brush\_cleaner\_tool.html?spm=a2700.shop\_index.11406.2.128de9e18ZckTj> (Year: 2022).\*

\* cited by examiner

*Primary Examiner* — Karen E Eldridge Powers  
(74) *Attorney, Agent, or Firm* — ScienBiziP, P.C.

(57) **CLAIM**

The ornamental design for a makeup brush fixing connector, as shown and described.

**DESCRIPTION**

FIG. 1 is a top perspective view of a makeup brush fixing connector, showing my design.

FIG. 2 is a bottom perspective view thereof.

FIG. 3 is a front elevation view thereof.

FIG. 4 is a rear elevation view thereof.

FIG. 5 is a left side elevation view thereof.

FIG. 6 is a right side elevation view thereof.

FIG. 7 is a top plan view thereof.

FIG. 8 is a bottom plan view thereof; and,

FIG. 9 is a front view showing a state of use of the makeup brush fixing connector with an unclaimed handle.

The broken lines in the drawings depict environmental subject matter. None of the broken lines form part of the claimed design.

**1 Claim, 9 Drawing Sheets**

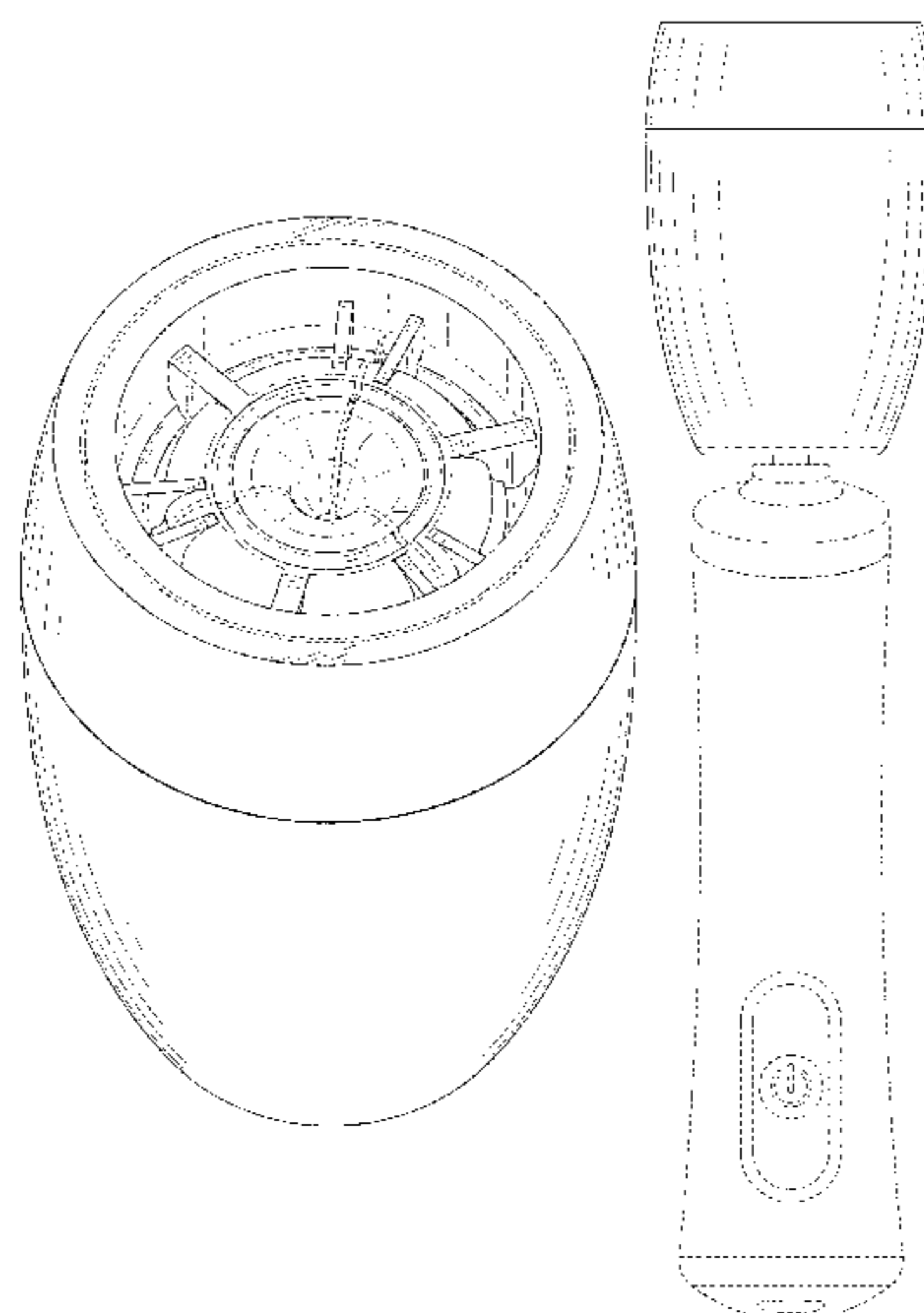

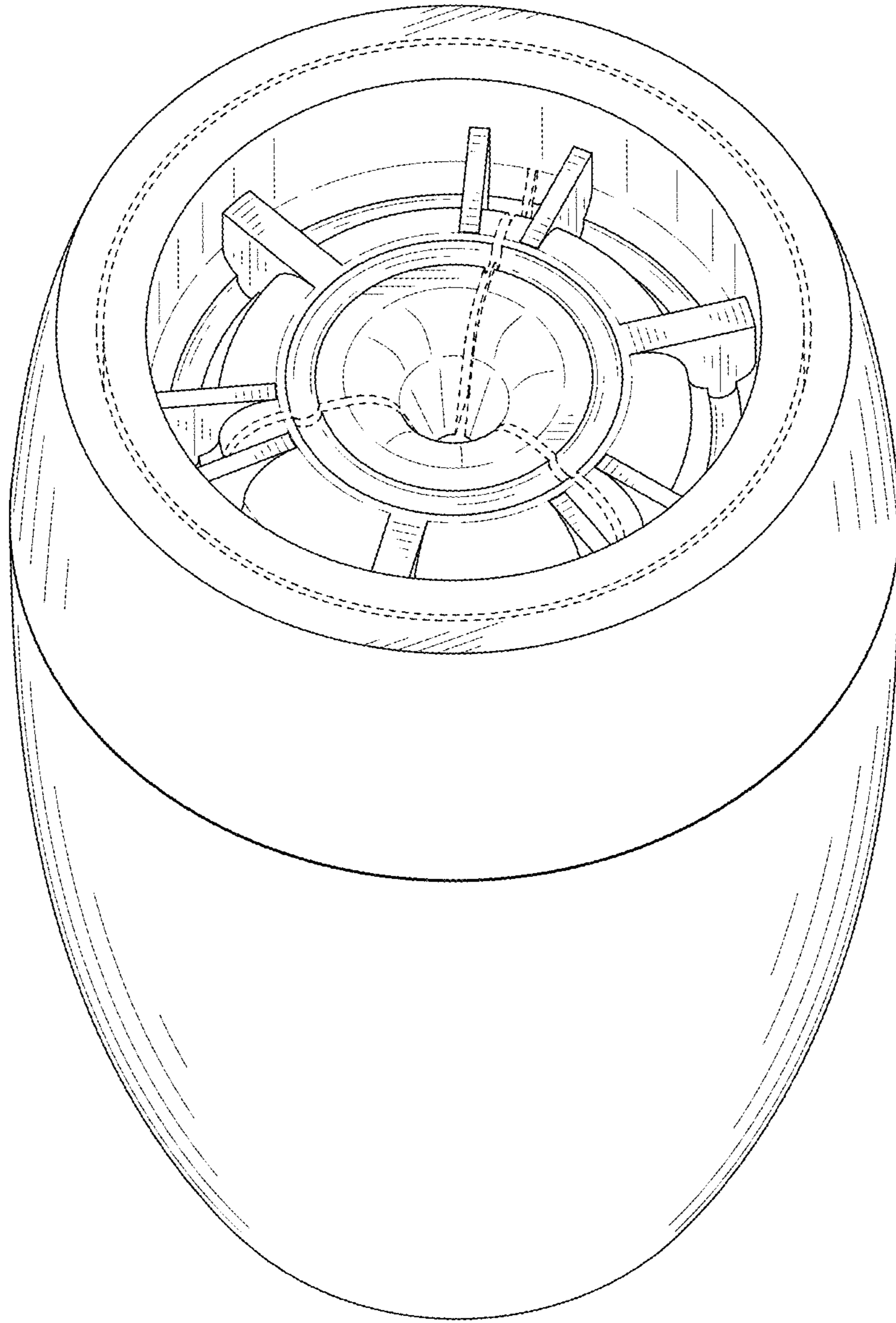

FIG. 1

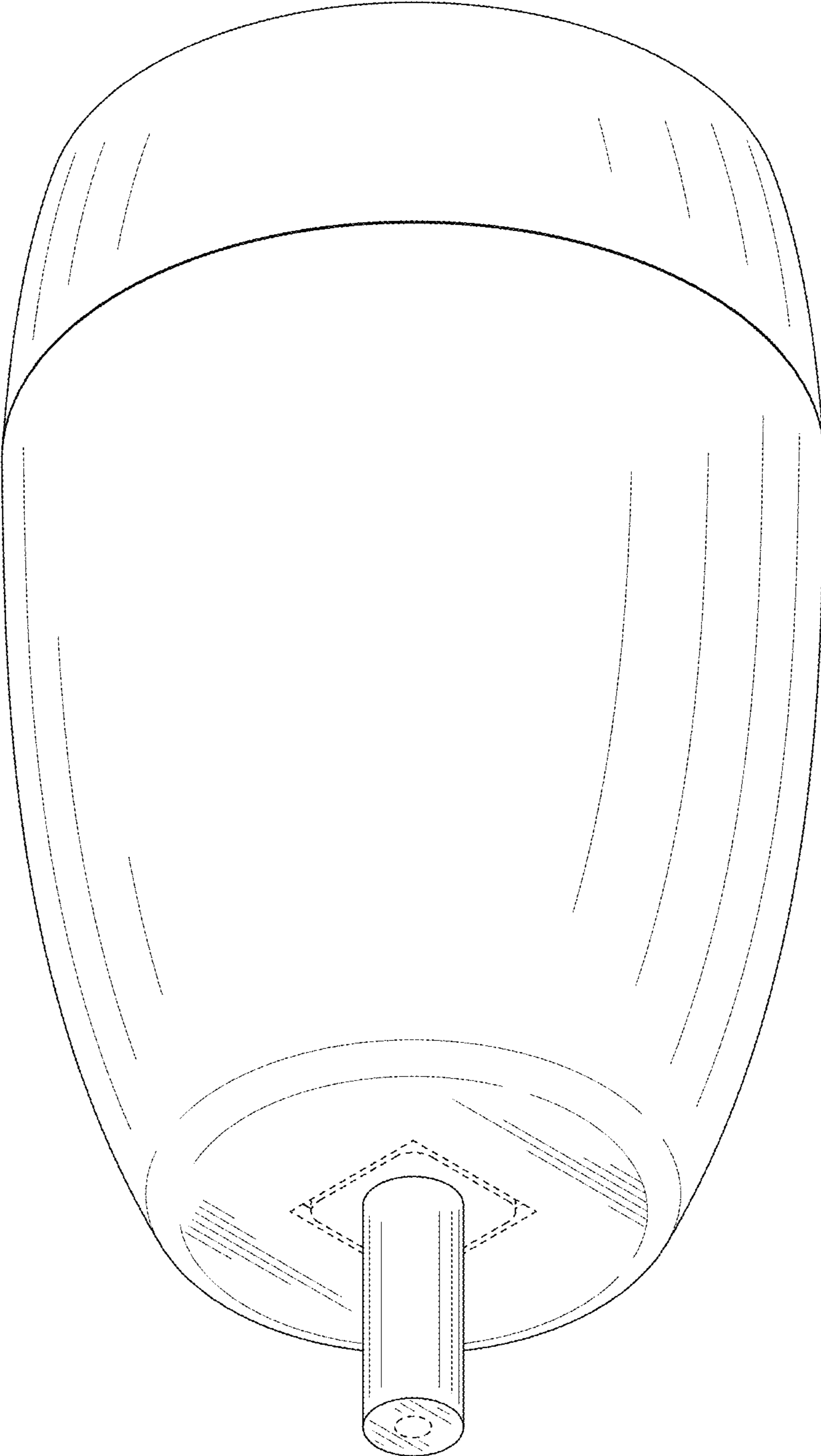

FIG. 2

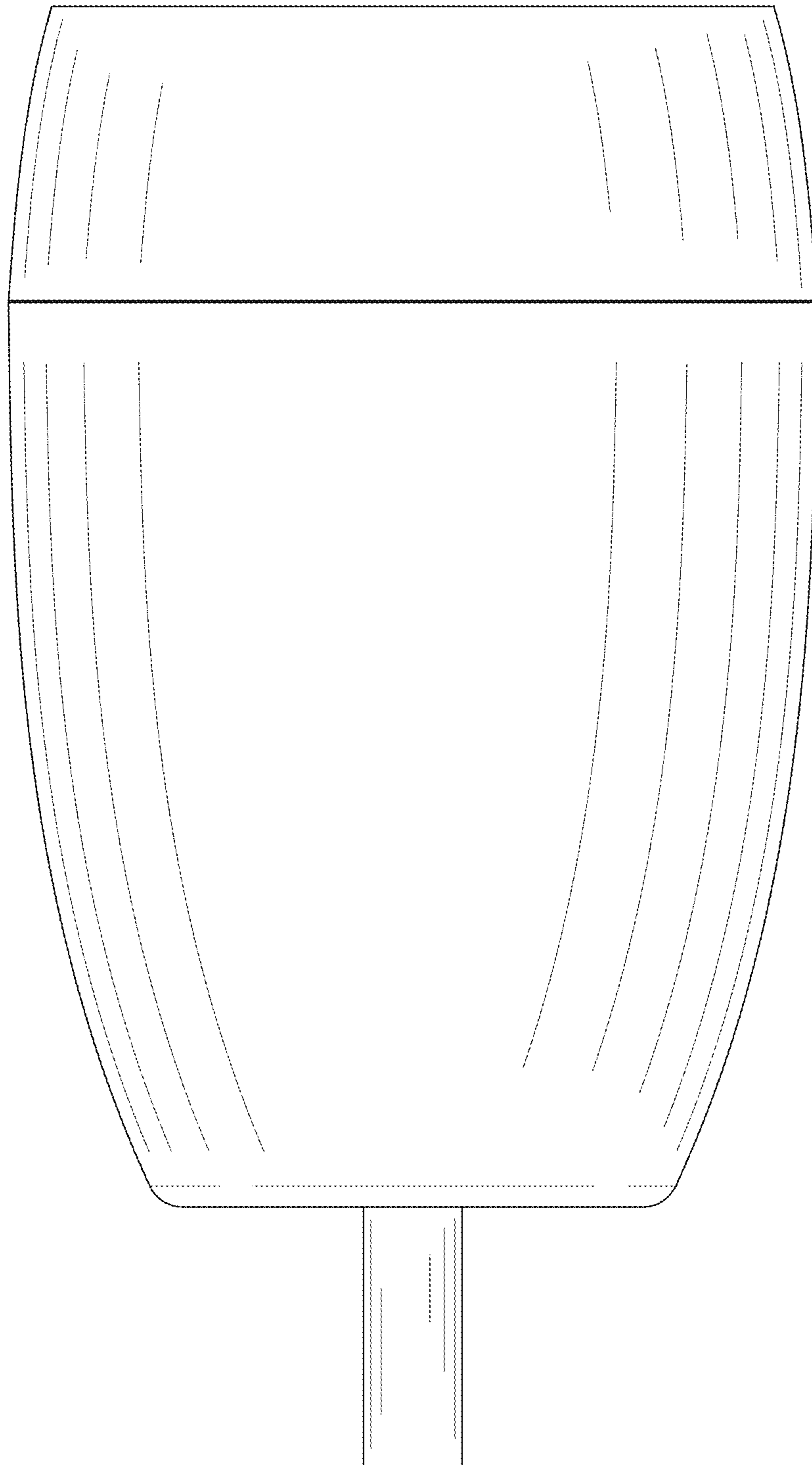

FIG. 3

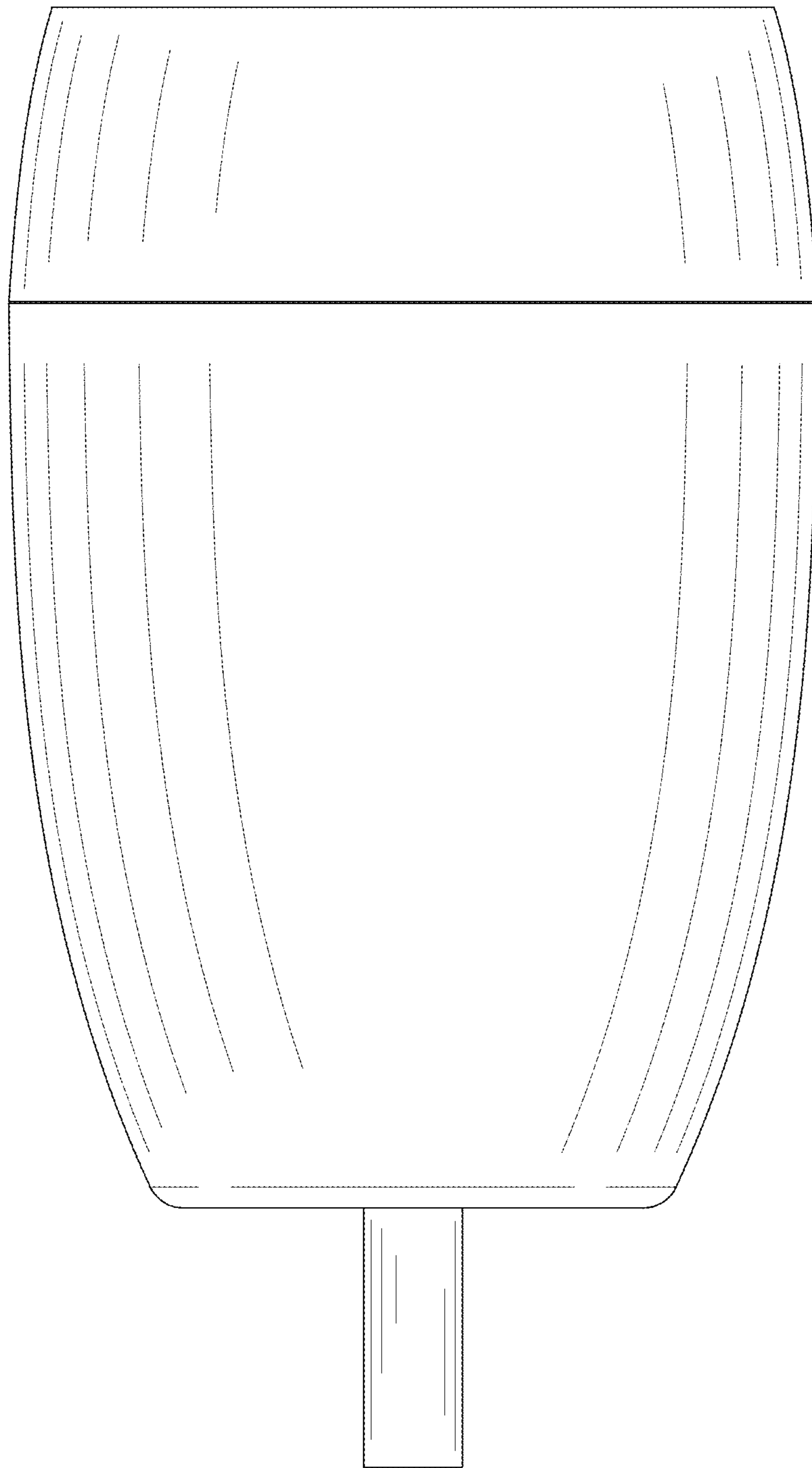

FIG. 4

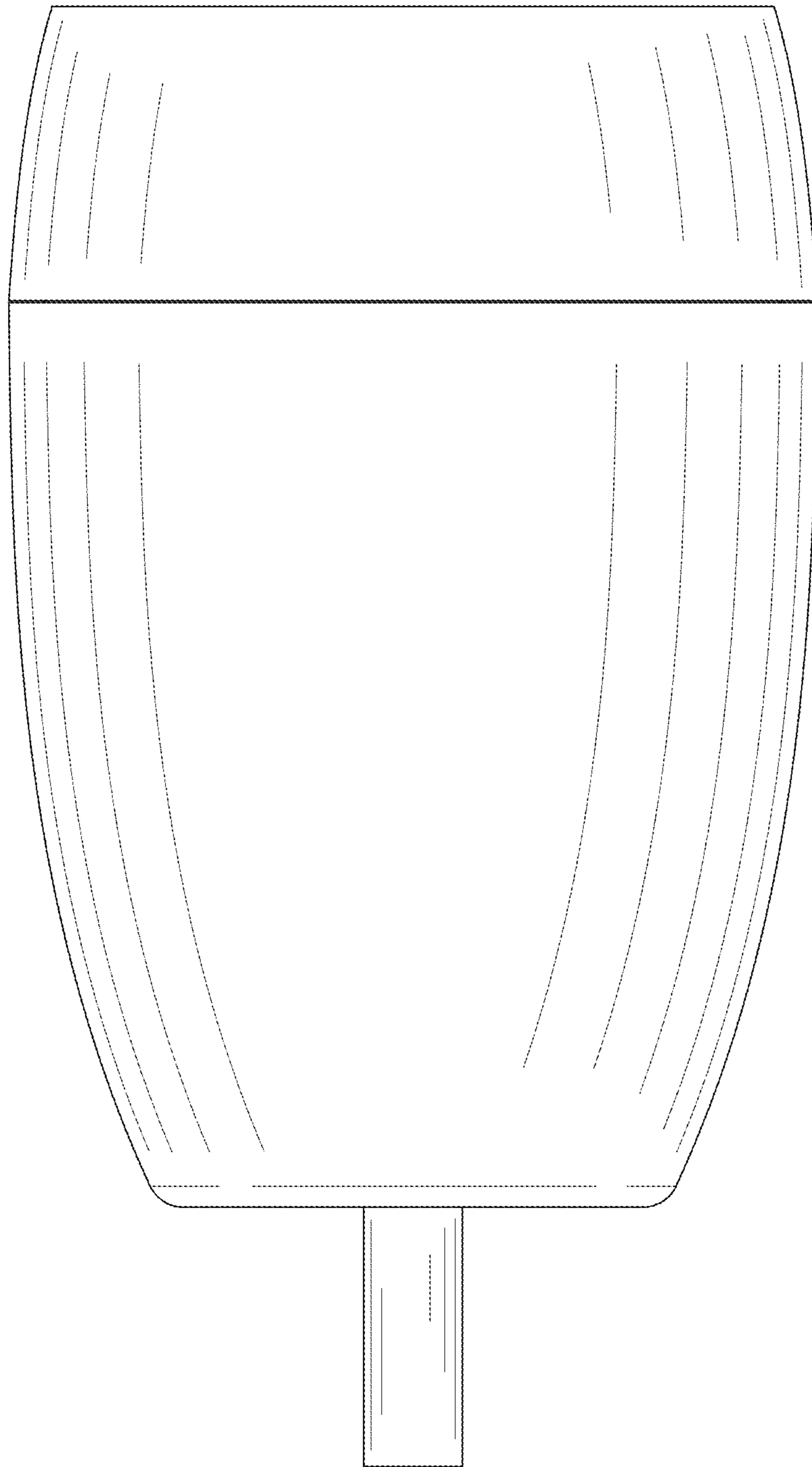

FIG. 5

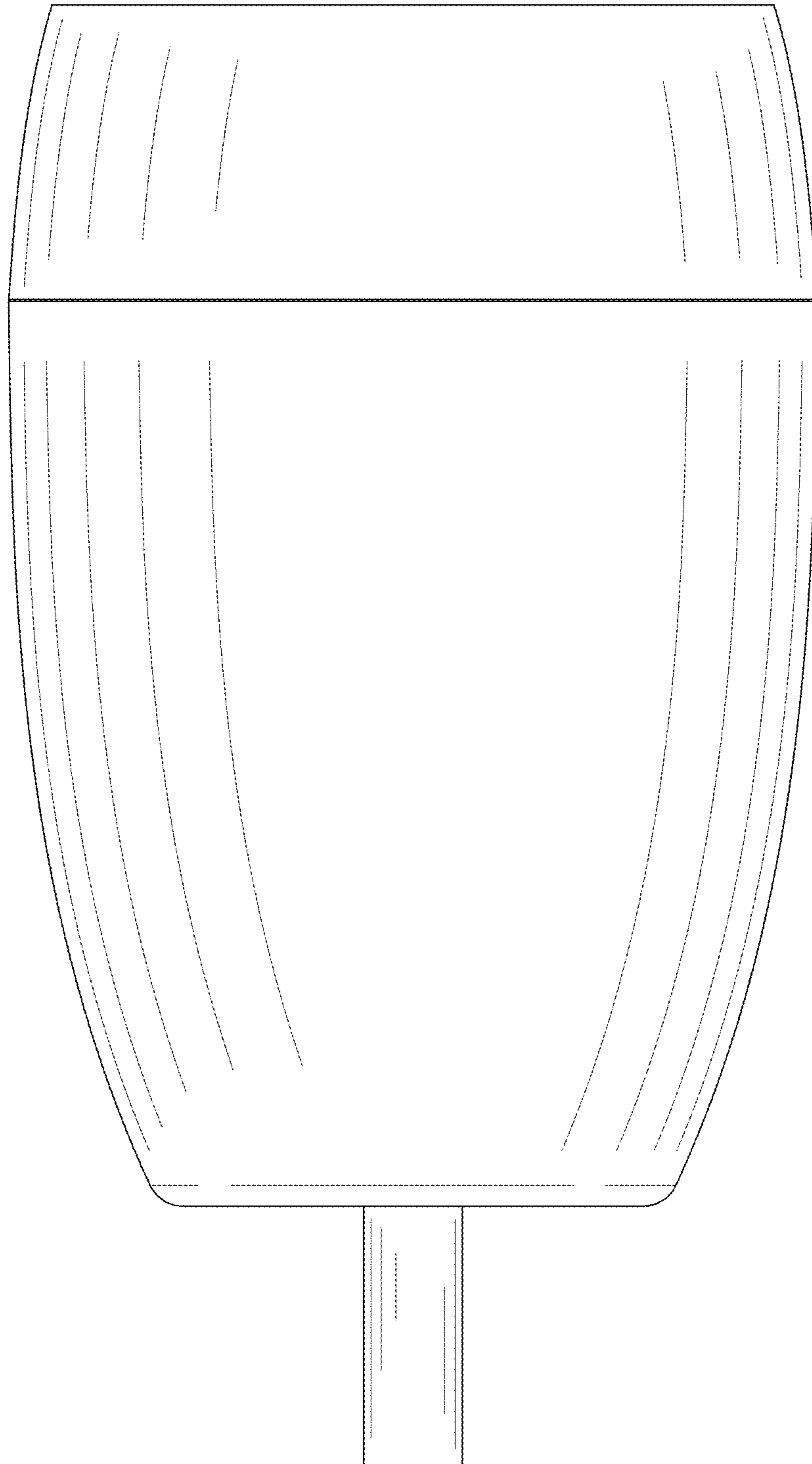

FIG. 6

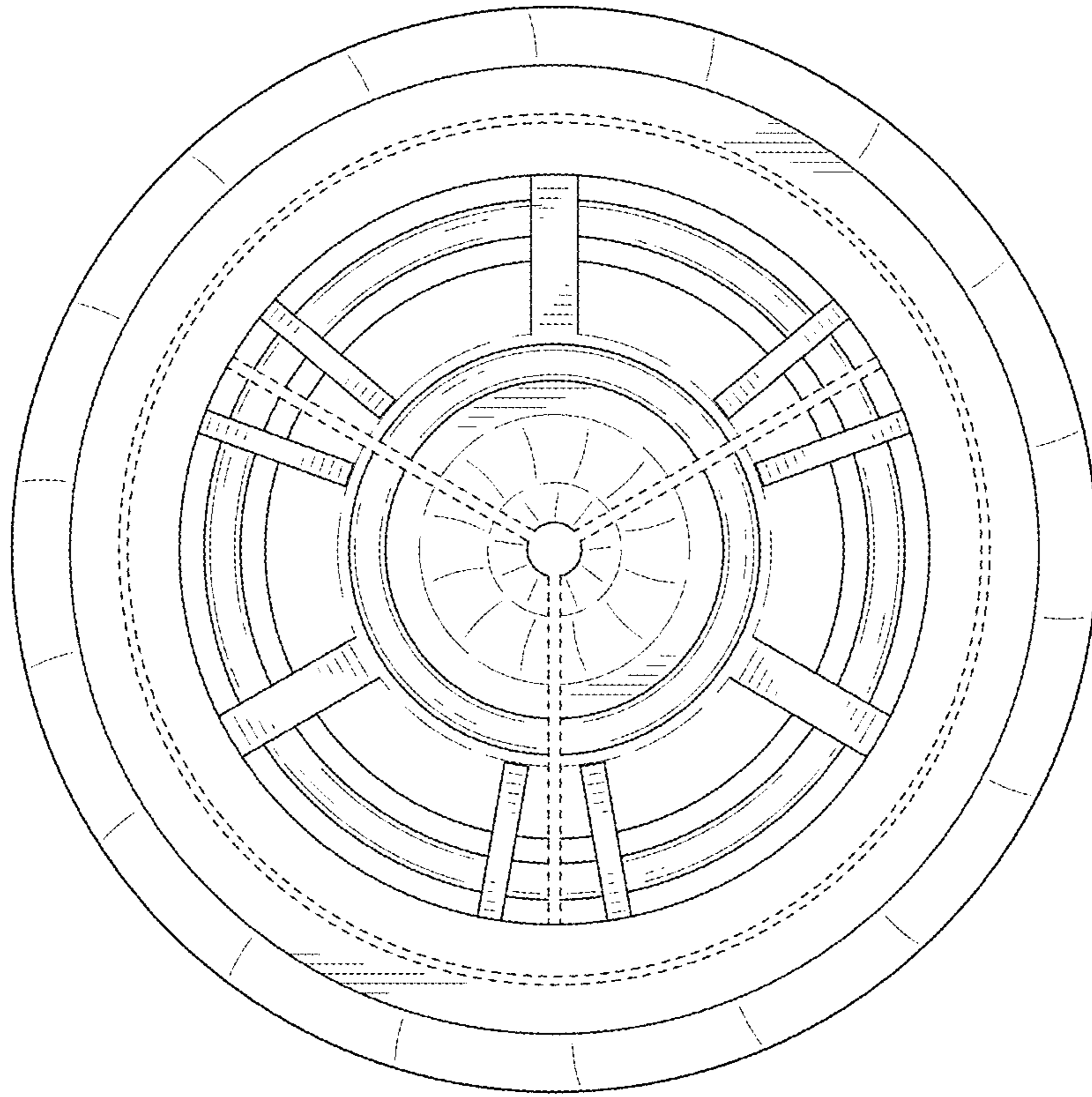

FIG. 7



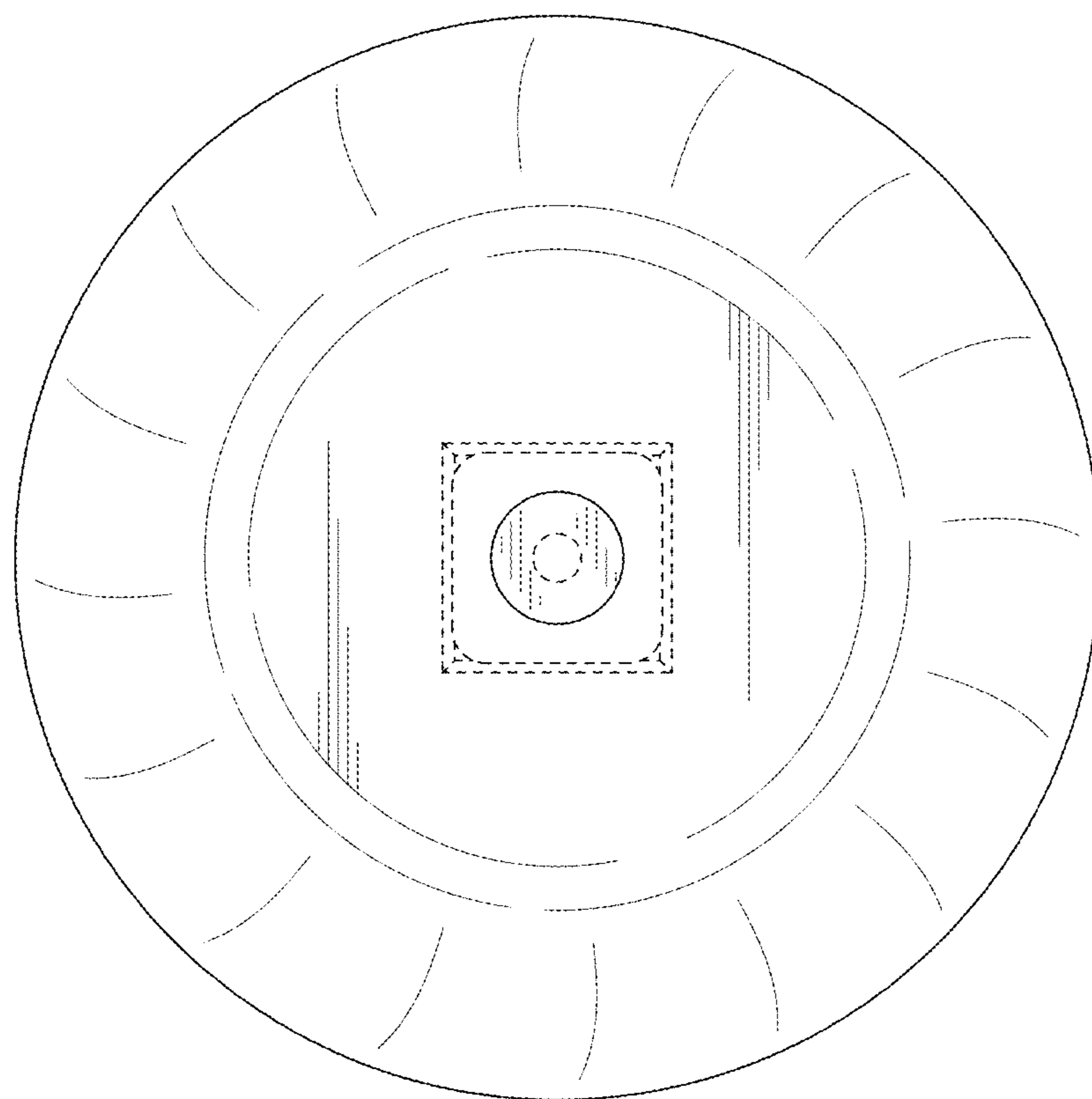

FIG. 8

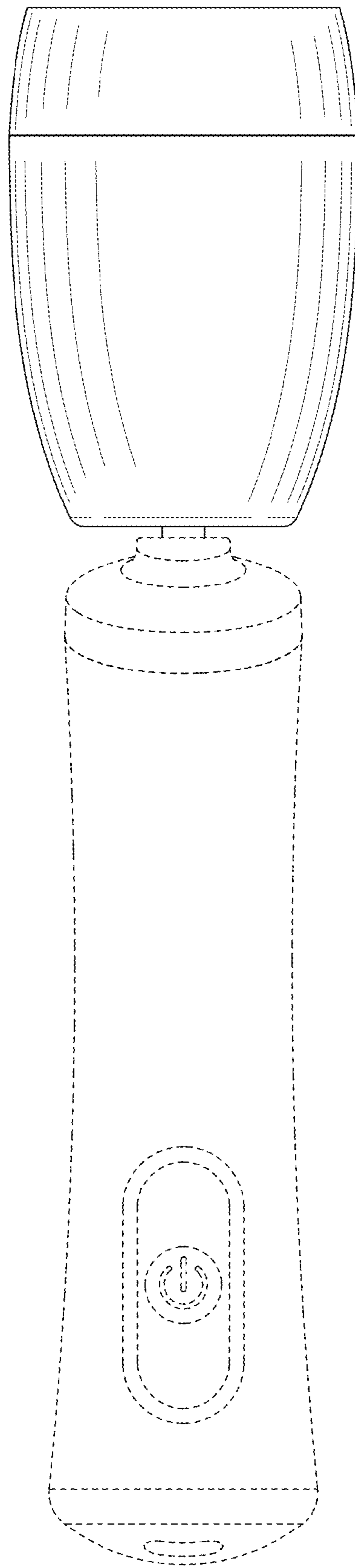

FIG. 9