



US00D971563S

(12) **United States Design Patent**
Piccioli

(10) **Patent No.:** **US D971,563 S**
(45) **Date of Patent:** **** Dec. 6, 2022**

- (54) **SHOE**
- (71) Applicant: **VALENTINO S.p.A.**, Milan (IT)
- (72) Inventor: **Pierpaolo Piccioli**, Milan (IT)
- (73) Assignee: **VALENTINO S.p.A.**, Milan (IT)
- (**) Term: **15 Years**
- (21) Appl. No.: **29/775,825**
- (22) Filed: **Mar. 25, 2021**

(30) **Foreign Application Priority Data**

Sep. 25, 2020 (FR) 2020-4321

(51) **LOC (13) Cl.** **02-04**

(52) **U.S. Cl.**
USPC **D2/916; D2/896**

(58) **Field of Classification Search**
USPC D2/896, 909, 913, 914, 916, 917, 919,
D2/925, 926, 927, 928, 929, 930, 931,
D2/932, 939, 940, 941, 942, 943, 946,
D2/965, 969, 971, 974
CPC A43B 1/00; A43B 1/06; A43B 1/0045;
A43B 3/00; A43B 3/10; A43B 3/101;
A43B 3/103; A43B 3/105; A43B 3/12;
A43B 3/122; A43B 3/124; A43B 3/126;
A43B 3/128; A43B 3/24; A43B 3/242;
A43B 23/00; A43B 23/021; A43B
23/0215; A43C 11/1493

See application file for complete search history.

(56) **References Cited**

U.S. PATENT DOCUMENTS

- 1,213,030 A * 1/1917 Skinner A43B 3/126
36/11.5
- D91,531 S * 2/1934 Morali D2/930
- D99,835 S * 5/1936 Tweedie D2/930
- 2,112,761 A * 3/1938 Buehner A43B 3/122
36/11.5

- D132,292 S * 5/1942 Benton D2/918
- 2,367,092 A * 1/1945 Blotner A43B 3/122
D2/918
- 3,063,166 A * 11/1962 Blavier A43B 3/105
36/11.5
- D279,326 S * 6/1985 Foldes D2/916

(Continued)

FOREIGN PATENT DOCUMENTS

CN 306772363 * 8/2021

OTHER PUBLICATIONS

Cape Robbin Presents Play Zimza Sandals Slides for Women, First available: May 17, 2021 [online], [visited: Jul. 19, 2022] Available from the internet URL: <https://www.amazon.com/Cape-Robbin-Presents-Sandals-Studded/dp/B09541QH2H/ref> (Year: 2021).*

(Continued)

Primary Examiner — Jonathan J Han
Assistant Examiner — Jeff Lenard D Torres
(74) *Attorney, Agent, or Firm* — Thomas | Horstemeyer, LLP

(57) **CLAIM**

The ornamental design for a shoe, as shown and described.

DESCRIPTION

FIG. 1 is a perspective view of a shoe, showing my new design;
FIG. 2 is a front view thereof;
FIG. 3 is a rear view thereof;
FIG. 4 is a side view thereof;
FIG. 5 is a side view thereof, opposite that of FIG. 4;
FIG. 6 is a top view thereof; and,
FIG. 7 is a bottom view thereof.
The dashed lines on the shoe upper represent stitching and form part of the claimed design.

1 Claim, 7 Drawing Sheets

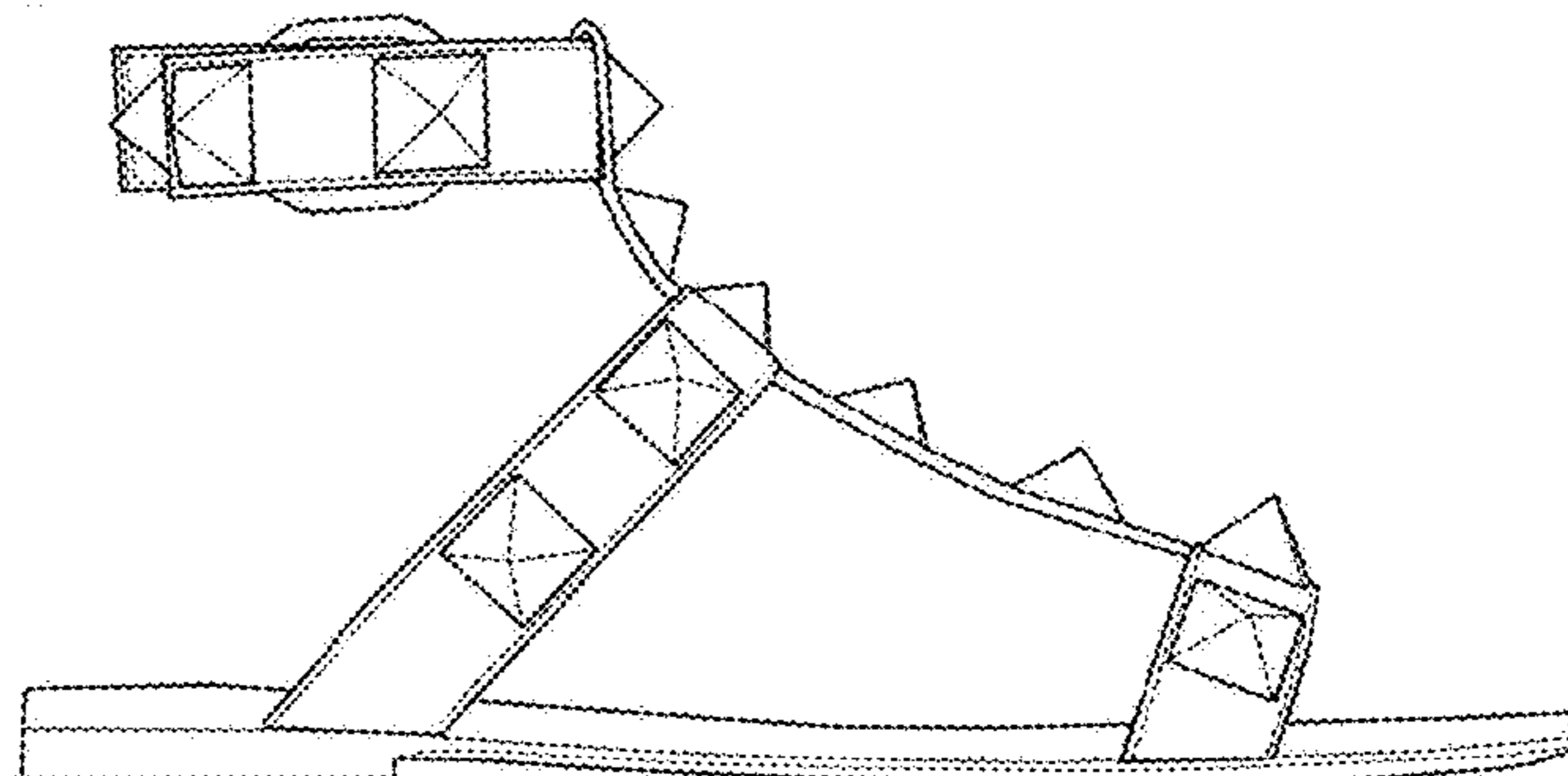
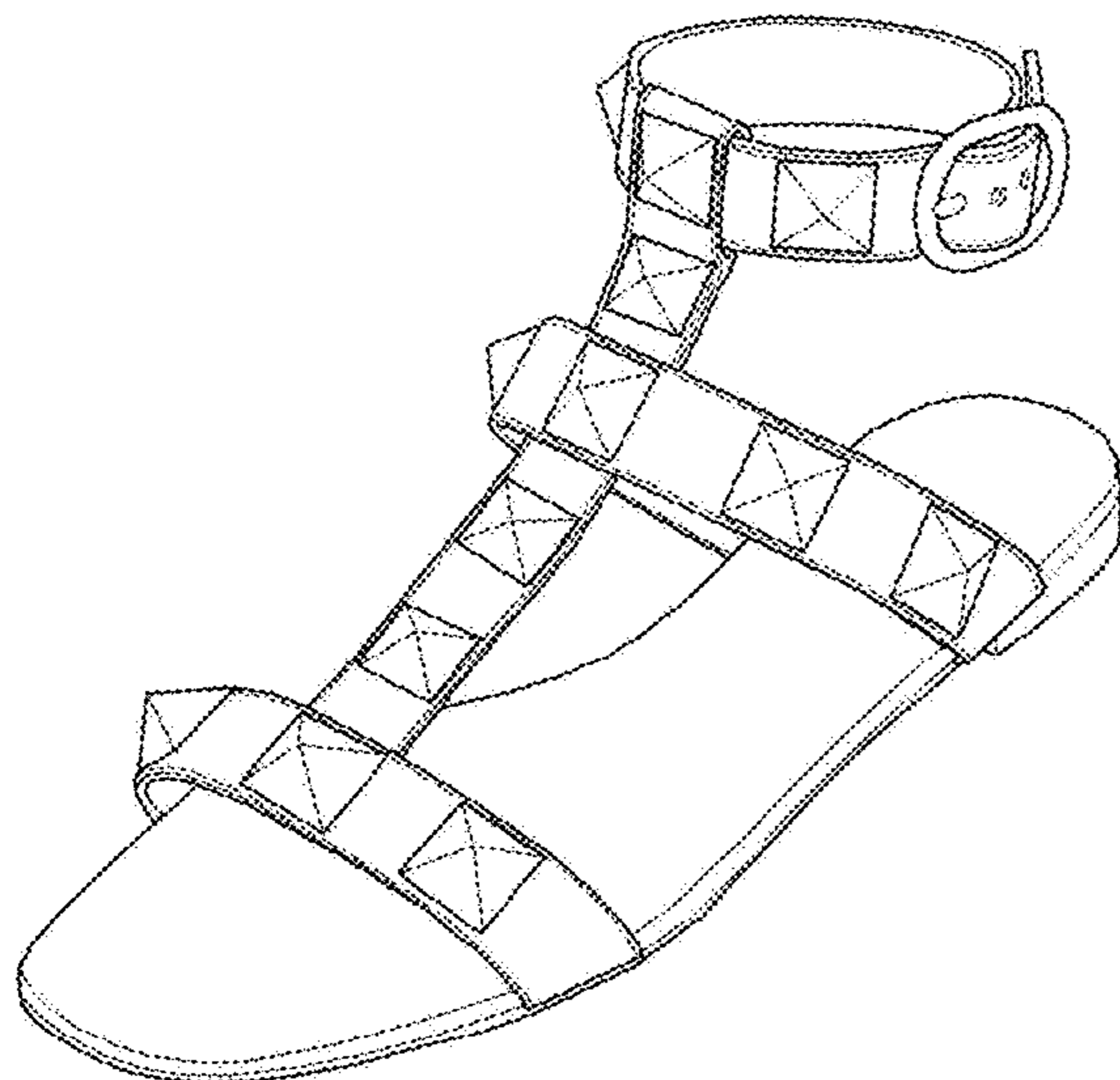

(56)

References Cited

U.S. PATENT DOCUMENTS

6,023,858 A * 2/2000 Srourian A43B 21/42
 36/11.5
 6,092,308 A * 7/2000 Srourian A43B 13/14
 36/11.5
 D558,439 S * 1/2008 Lawler D2/971
 D708,823 S * 7/2014 Katz D2/916
 D740,000 S * 10/2015 Sassi D2/929
 D764,777 S * 8/2016 Sassi D2/930
 D792,079 S * 7/2017 Negri D2/971
 D811,703 S * 3/2018 Sassi D2/939
 D812,354 S * 3/2018 Sassi D2/939
 D814,163 S * 4/2018 Issler D2/971
 D818,249 S * 5/2018 Sassi D2/916
 D818,250 S * 5/2018 Sassi D2/916
 D827,260 S * 9/2018 Sassi D2/930
 D834,794 S * 12/2018 Sassi D2/939
 D835,892 S * 12/2018 Sassi D2/916
 D838,942 S * 1/2019 Sassi D2/896
 D890,482 S * 7/2020 Sassi D2/966

D922,740 S * 6/2021 Post D2/951
 D946,249 S * 3/2022 Lin D2/947
 2014/0331521 A1* 11/2014 Katz A43B 3/242
 36/100

OTHER PUBLICATIONS

Putu Women Braided Heeled Sandals Square Toe, First available: Nov. 23, 2021 [online], [visited: Jul. 19, 2022] Available from the internet URL: <https://www.amazon.com/Putu-Studded-Sandals-Stiletto-Gladiator/dp/B09NY4HP54/ref> (Year: 2021).*

Putu Women Flat Sandals Studded Square Toe, First available: Jun. 2, 2022 [online], [visited: Jul. 19, 2022] Available from the internet URL: <https://www.amazon.com/Putu-Sandals-Studded-Square-Strappy/dp/B09PY6MSP4/ref> (Year: 2022).*

Steve Madden Women's Travel Flat Sandal, First available: Nov. 5, 2019 [online], [visited: Jul. 19, 2022] Available from the internet URL: <https://www.amazon.com/Steve-Madden-Travel-Flat-Sandal/dp/B083CYPM8H/ref> (Year: 2019).*

* cited by examiner

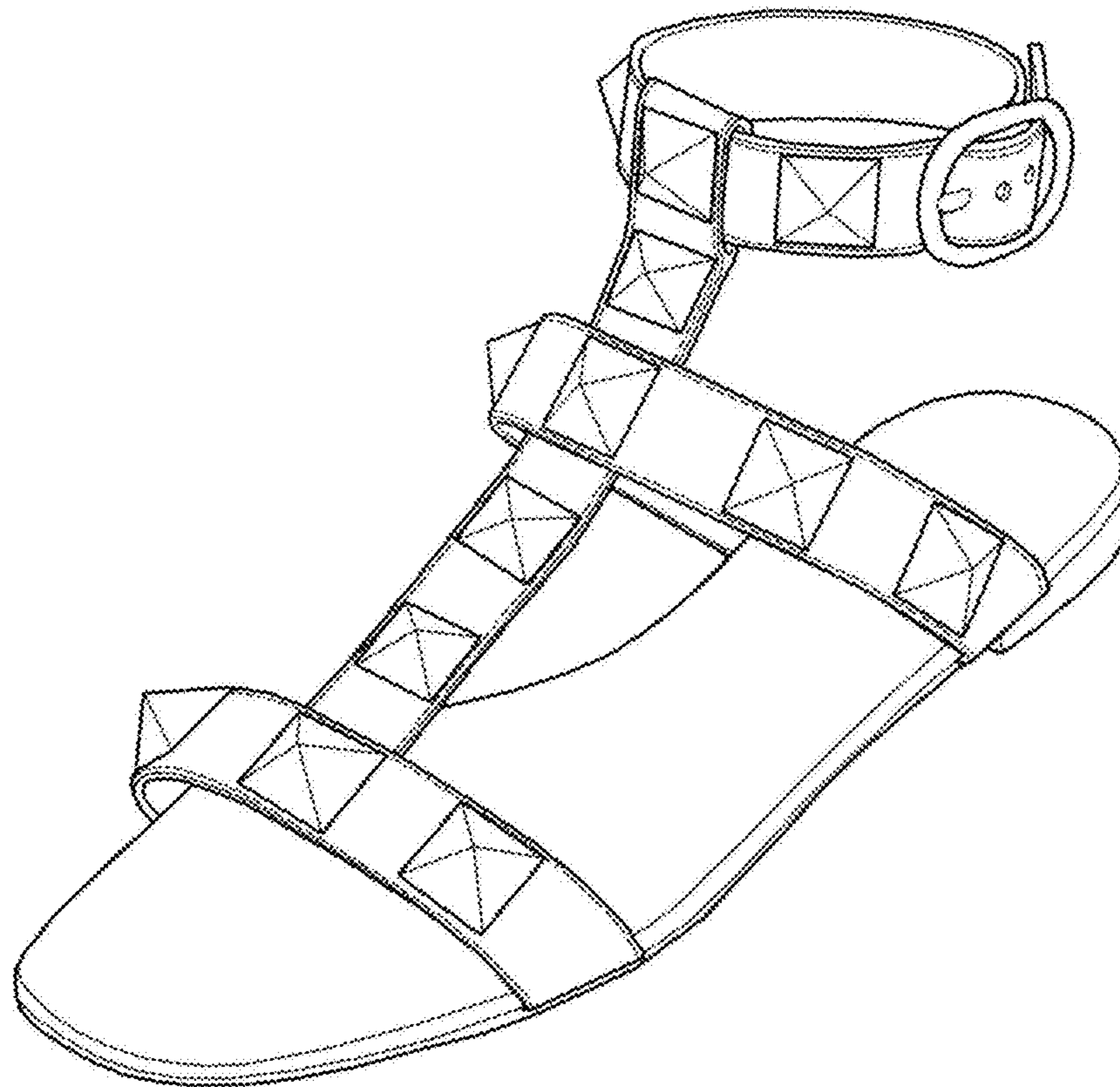

FIG. 1

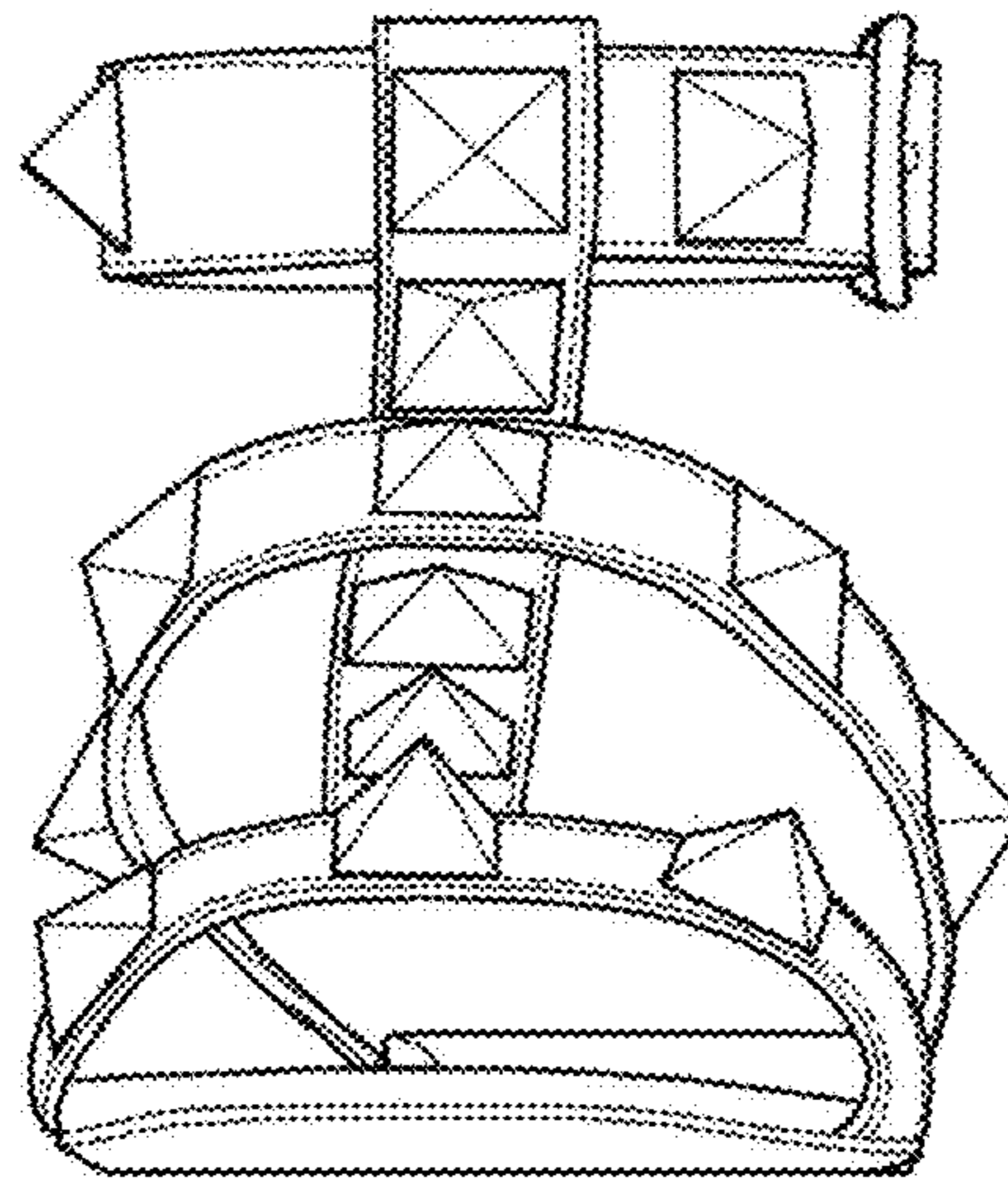

FIG. 2

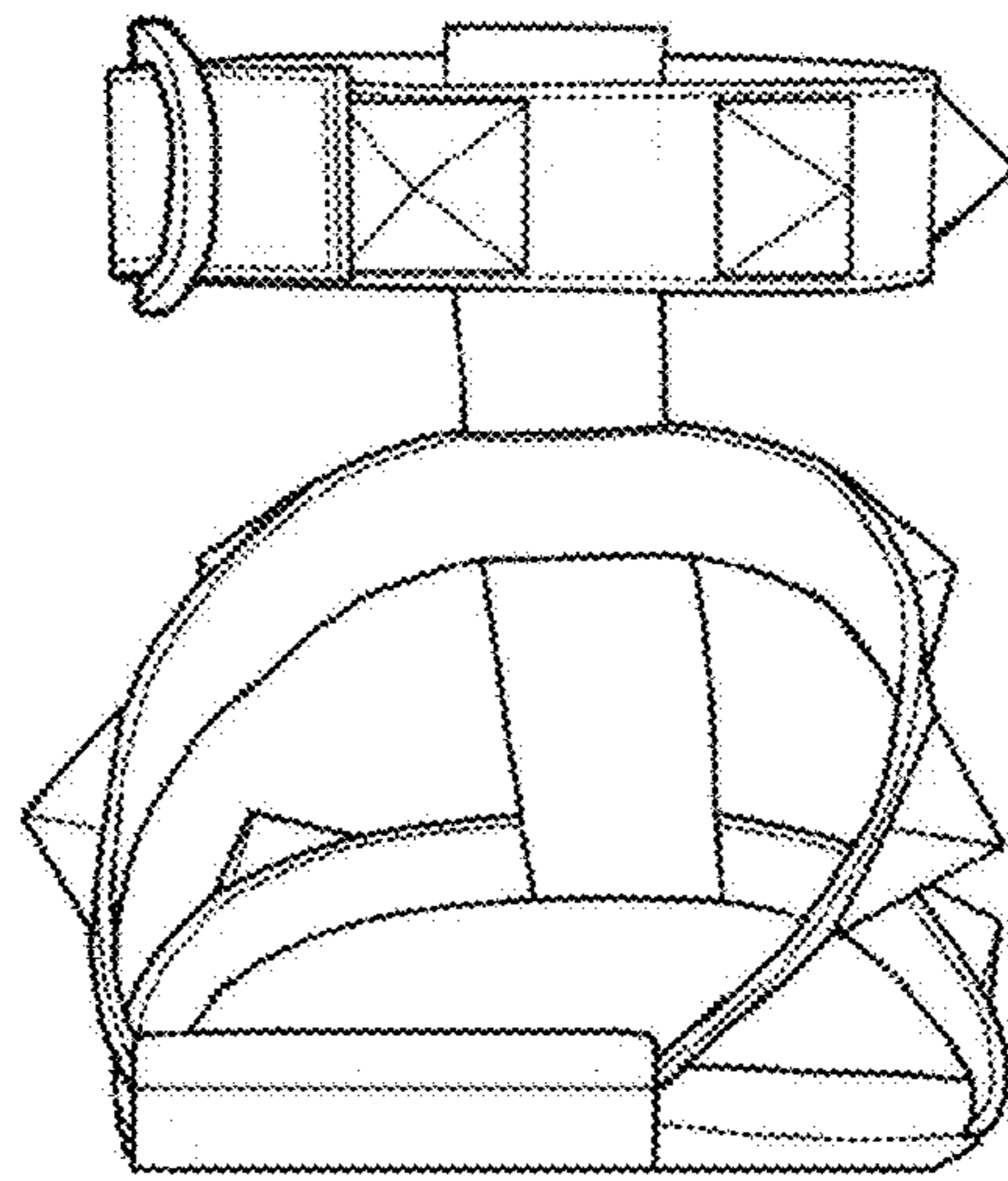

FIG. 3

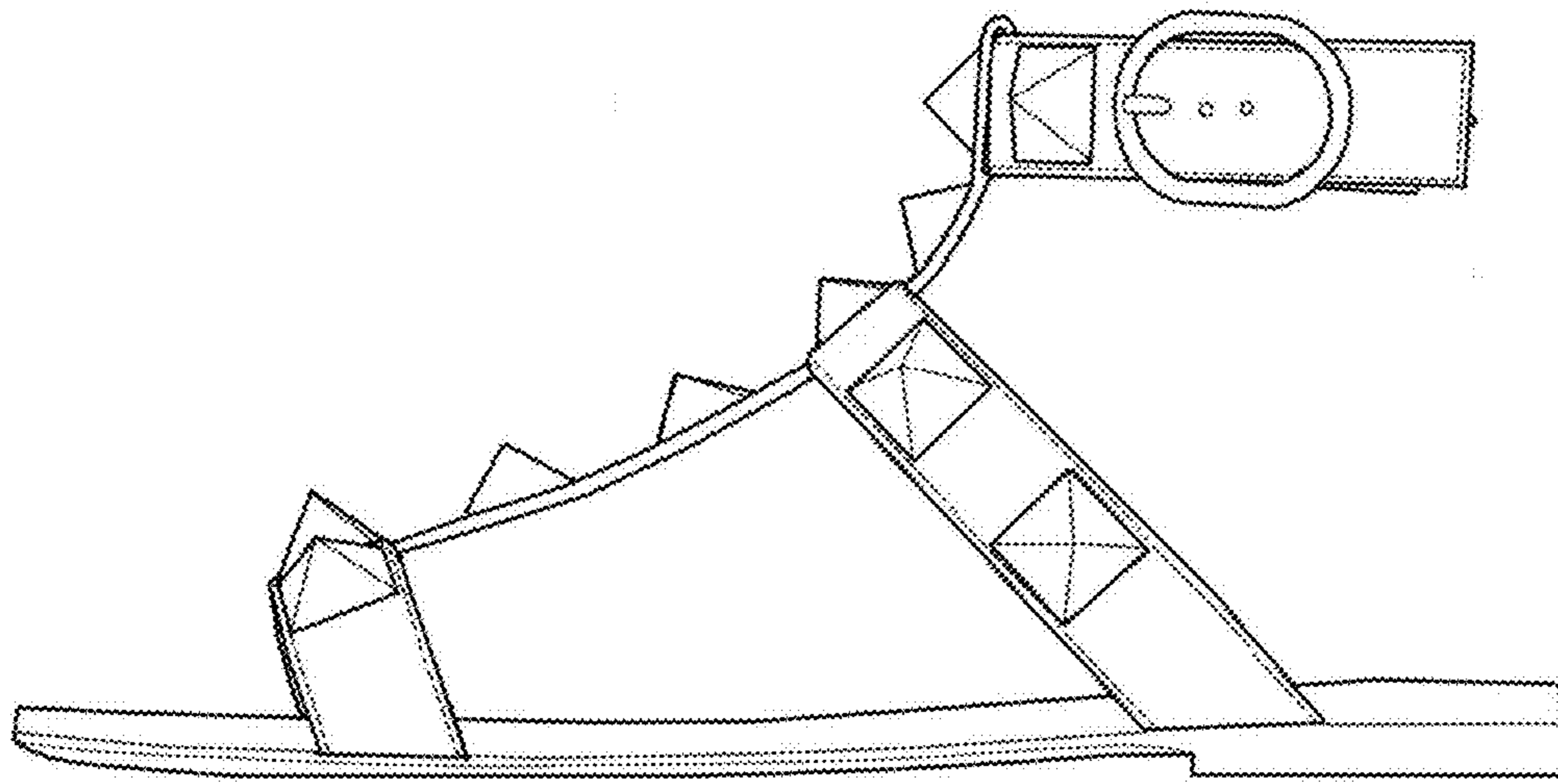

FIG. 4

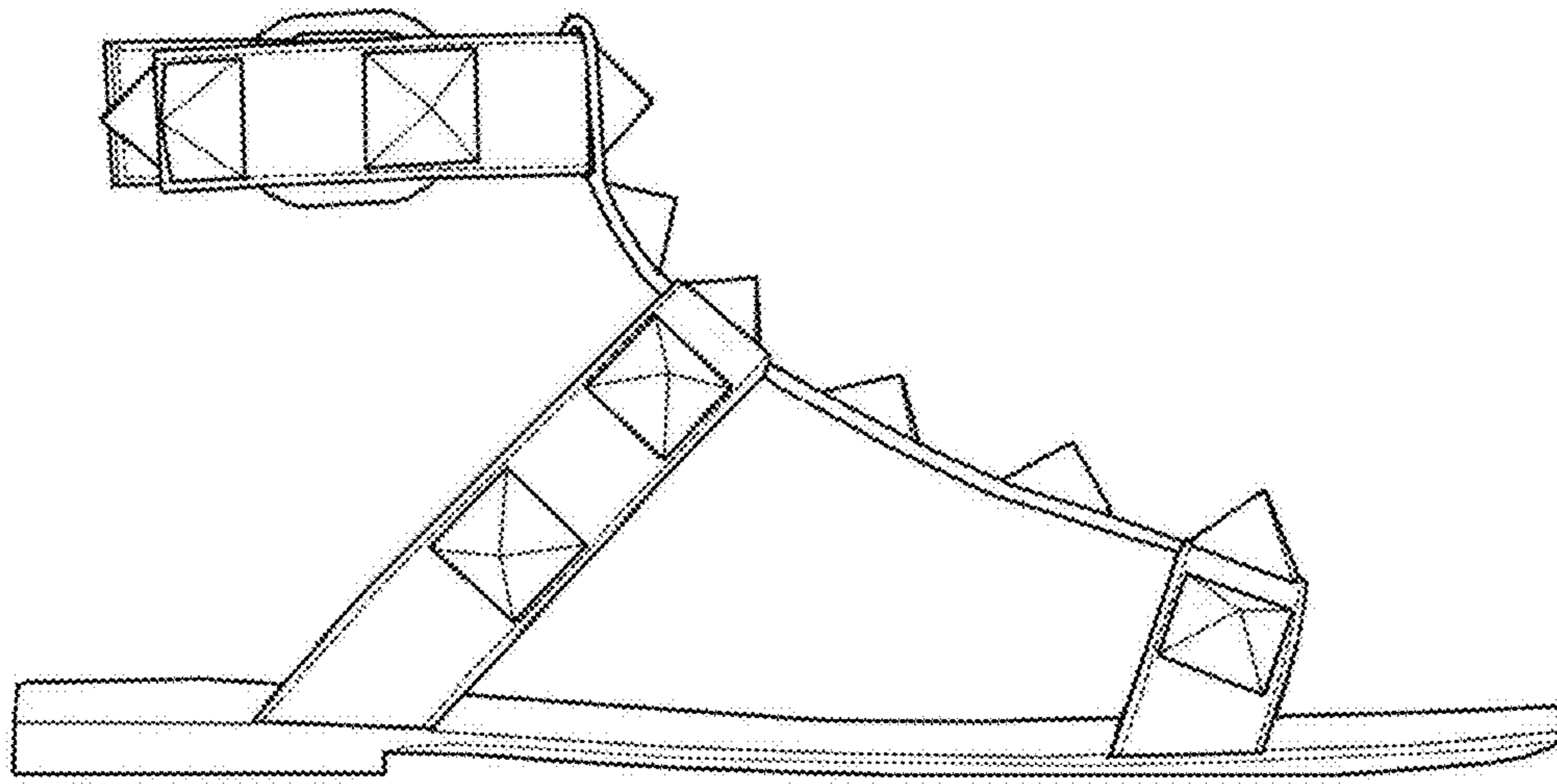

FIG. 5

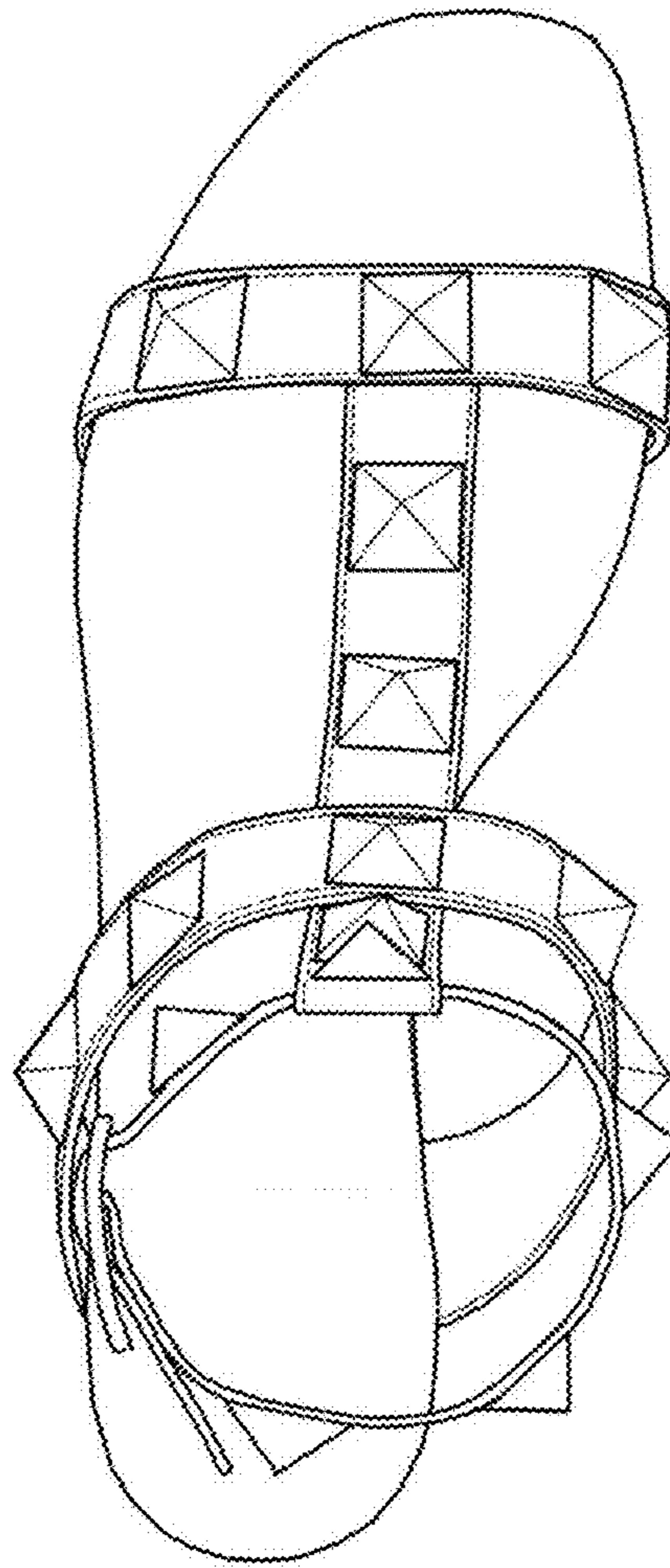

FIG. 6

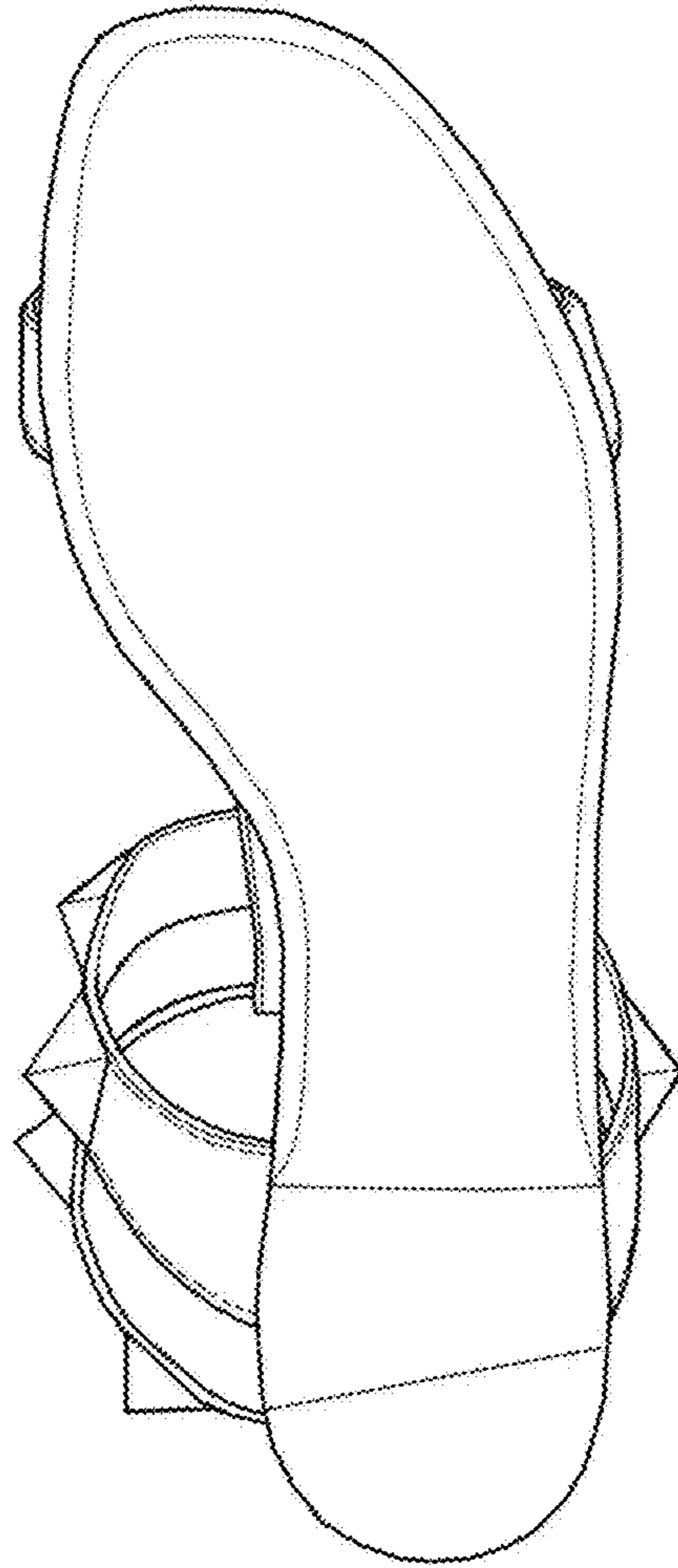

FIG. 7