



US00D971542S

(12) **United States Design Patent** (10) **Patent No.:** **US D971,542 S**
Xiao (45) **Date of Patent:** **** Nov. 29, 2022**

(54) **TRASH CAN**

OTHER PUBLICATIONS

(71) Applicant: **TAIZHOU SUKK TECHNOLOGY CO., LTD**, Taizhou (CN)

Sukk trash bin single, announced 2022 [online], [site visited Aug. 5, 2022]. Avail from int, URL: https://www.alibaba.com/product-detail/SUKK-118L-KD-Plastic-Weatherproof-Garden_1600527987100.html (Year: 2022).*

(72) Inventor: **Shuangshuang Xiao**, Taizhou (CN)

(Continued)

(73) Assignee: **TAIZHOU SUKK TECHNOLOGY CO., LTD**, Taizhou (CN)

Primary Examiner — Cynthia Ramirez
Assistant Examiner — Tamara L Hahn

(**) Term: **15 Years**

(21) Appl. No.: **29/834,170**

(57) **CLAIM**

(22) Filed: **Apr. 11, 2022**

(51) **LOC (13) Cl.** **09-09**

The ornamental design for a trash can, as shown and described.

(52) **U.S. Cl.**

USPC **D34/7**

(58) **Field of Classification Search**

DESCRIPTION

USPC D34/1-11; D32/37; D9/737, 738, 770, D9/772, 777, 778, 743-745, 428, 429; D7/509, 523, 527, 531; D11/143, 152
CPC B65F 1/1608; B65F 1/068; B65F 1/06; B65F 1/062; B65F 2230/134; B65F 2220/12; B65F 2250/114

See application file for complete search history.

FIG. 1 is a front and top perspective view of a trash can, showing my new design;
FIG. 2 is a front and bottom perspective view thereof;
FIG. 3 is a front elevation view thereof;
FIG. 4 is a rear view thereof;
FIG. 5 is a left side elevation view thereof;
FIG. 6 is a right side elevation view thereof;
FIG. 7 is a top plan view thereof;
FIG. 8 is a bottom plan view thereof;
FIG. 9 is a front and top perspective view of a second embodiment of a trash can, showing my new design;
FIG. 10 is a front and bottom perspective view thereof;
FIG. 11 is a front elevation view thereof;
FIG. 12 is a rear view thereof;
FIG. 13 is a left side elevation view thereof;
FIG. 14 is a right side elevation view thereof;
FIG. 15 is a top plan view thereof; and,
FIG. 16 is a bottom plan view thereof.

(56) **References Cited**

U.S. PATENT DOCUMENTS

D332,851 S * 1/1993 Long D34/1
D337,188 S * 7/1993 Bonskowski D6/683
D351,697 S * 10/1994 Blotnick D34/1
D507,687 S 7/2005 Moon et al.
7,073,677 B2 * 7/2006 Richardson B65F 1/02
220/908
D545,023 S * 6/2007 Weiss D34/1
D625,478 S * 10/2010 Cittadino D32/37
D725,860 S 3/2015 Spivey et al.
D829,400 S 9/2018 Yang et al.
D855,917 S * 8/2019 Wang D32/37
D855,919 S 8/2019 Yang et al.
D860,569 S 9/2019 Lin et al.
D872,959 S 1/2020 Chen

The broken lines depict portions of the trash can in which the design is embodied that form no part of the claimed design.

(Continued)

1 Claim, 16 Drawing Sheets

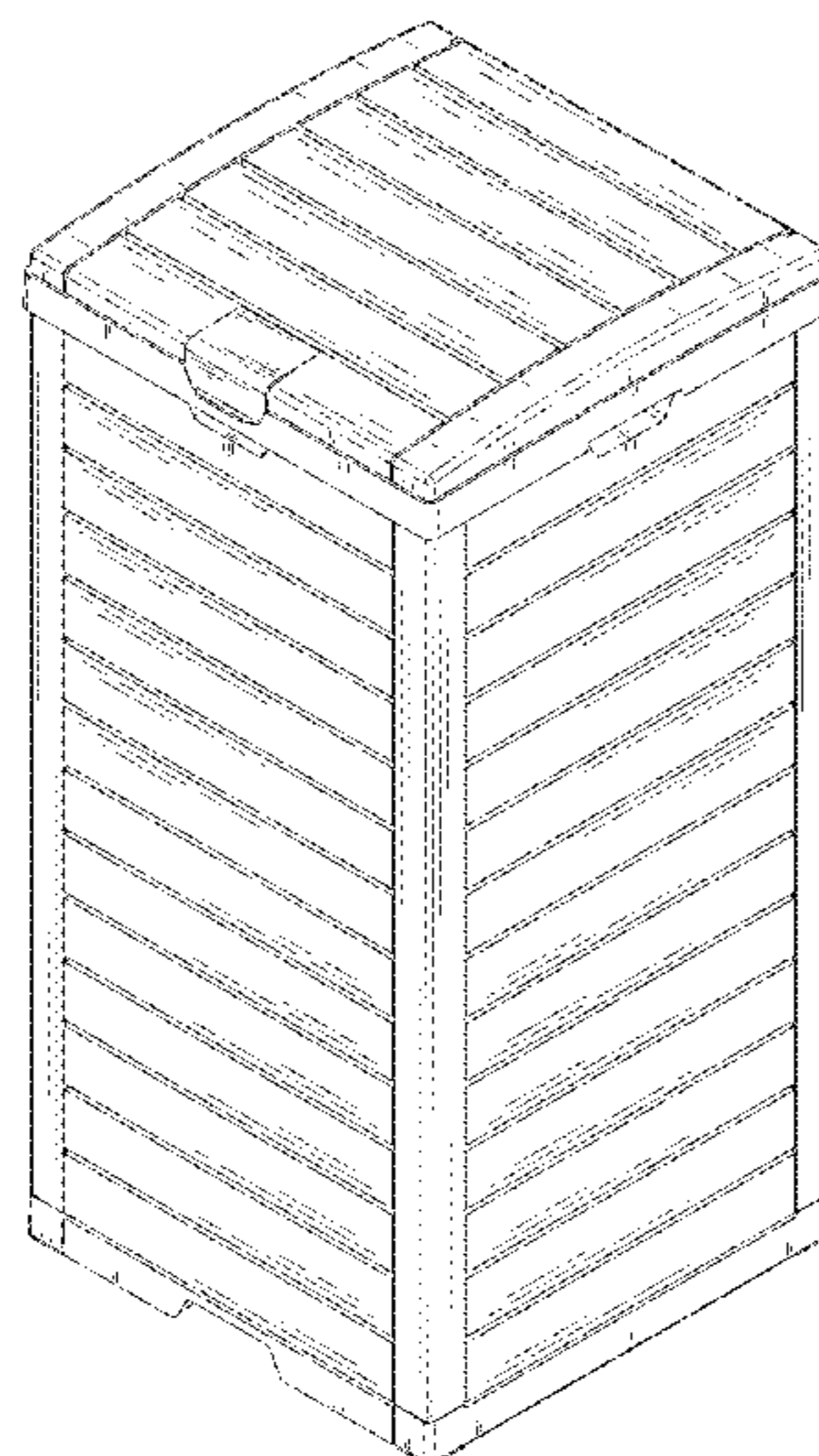

(56)

References Cited

U.S. PATENT DOCUMENTS

D899,404 S * 10/2020 Adrian D11/155
D930,933 S 9/2021 Yang et al.
D936,323 S 11/2021 Blitzer et al.
2007/0138172 A1 * 6/2007 Richardson B65F 1/02
220/4.01
2018/0105476 A1 * 4/2018 Wallis C05F 17/957

OTHER PUBLICATIONS

Sukk trash bin double, announced 2022 [online], [site visited Aug. 5, 2022]. Avail from int, URL: https://www.alibaba.com/product-detail/SUKK-230L-KD-Plastic-Weatherproof-Garden_1600529298934.html (Year: 2022).*

Keter, announced 2018 [online], [site visited Aug. 5, 2022]. Avail from int, URL: <https://www.walmart.com/ip/Keter-Baltimore-Duotech-Outdoor-Trash-Can-Resin-Wastebin-Black-Woodlook/186602797> (Year: 2018).*

Keter double, announced 2017 [online], [site visited Aug. 5, 2022]. Avail from int, URL: <https://www.amazon.com/dp/B01994IQYE?tag=ph-garbageshed-20&linkCode=ogi&th=1&psc=1> (Year: 2017).*

Suncast, announced Jan. 2020 [online], [site visited Aug. 5, 2022]. Avail from int, URL: https://www.amazon.com/dp/B08461BYMM/ref=sspa_dk_detail_1 (Year: 2020).*

* cited by examiner

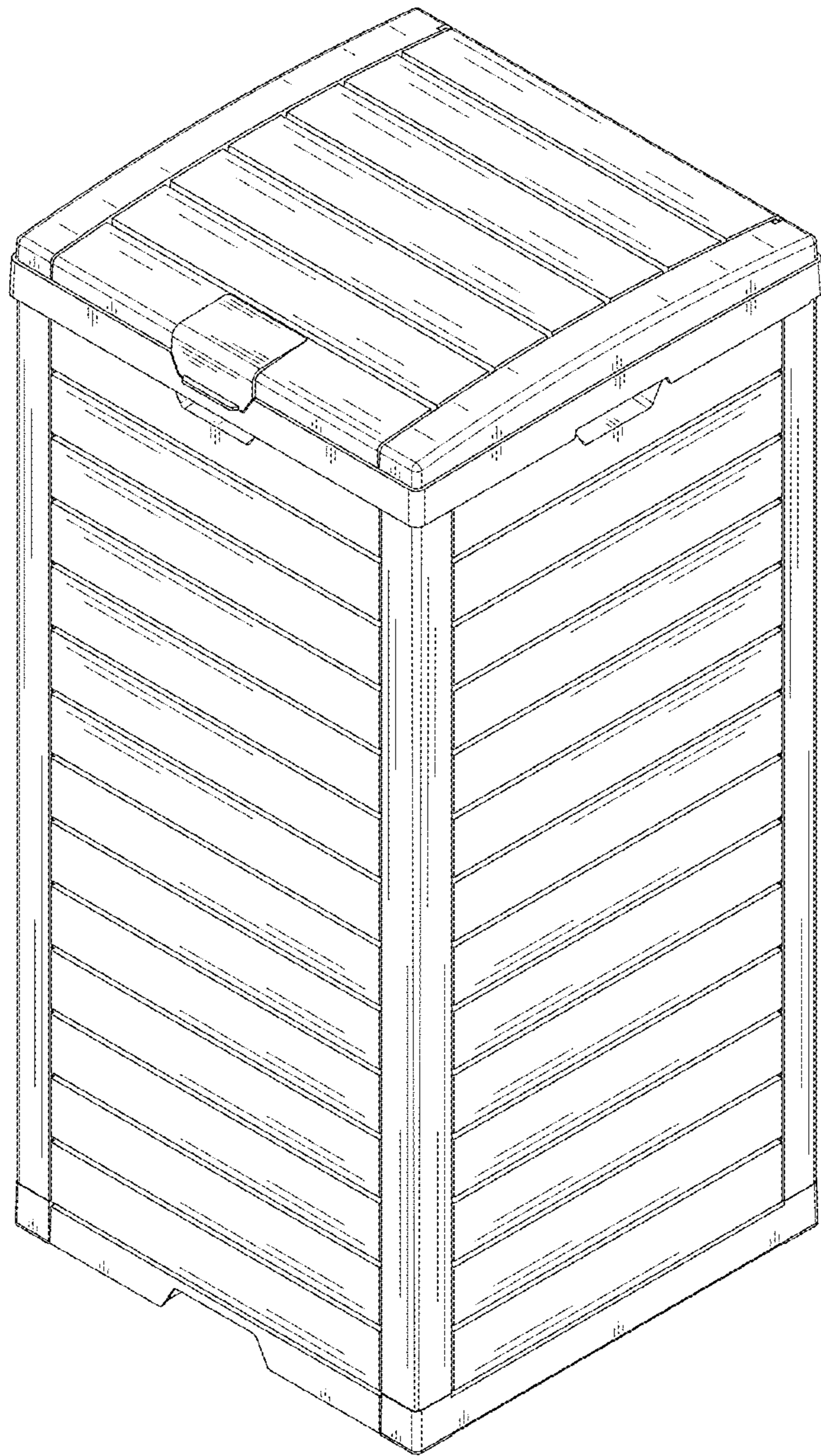

FIG. 1

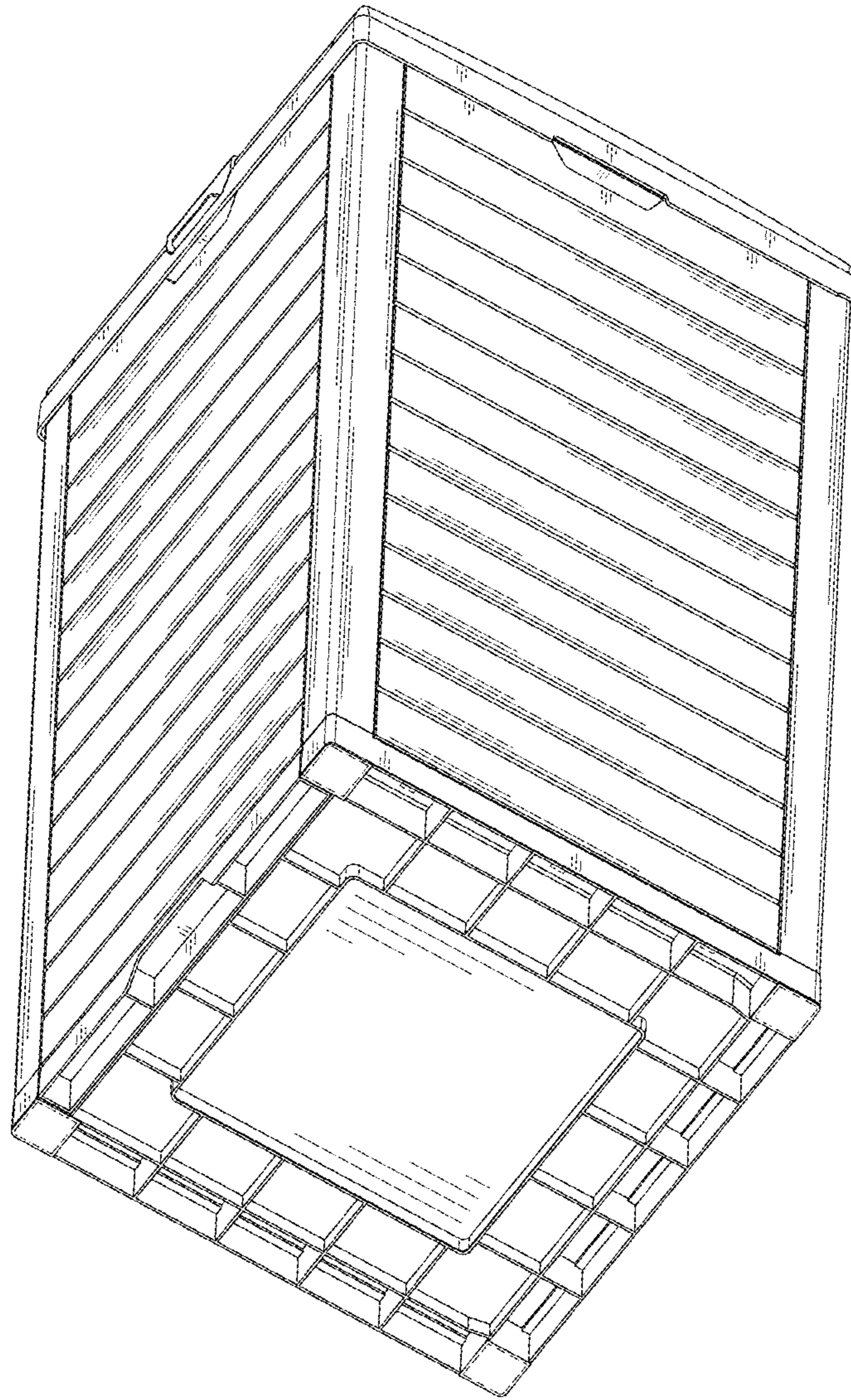

FIG. 2

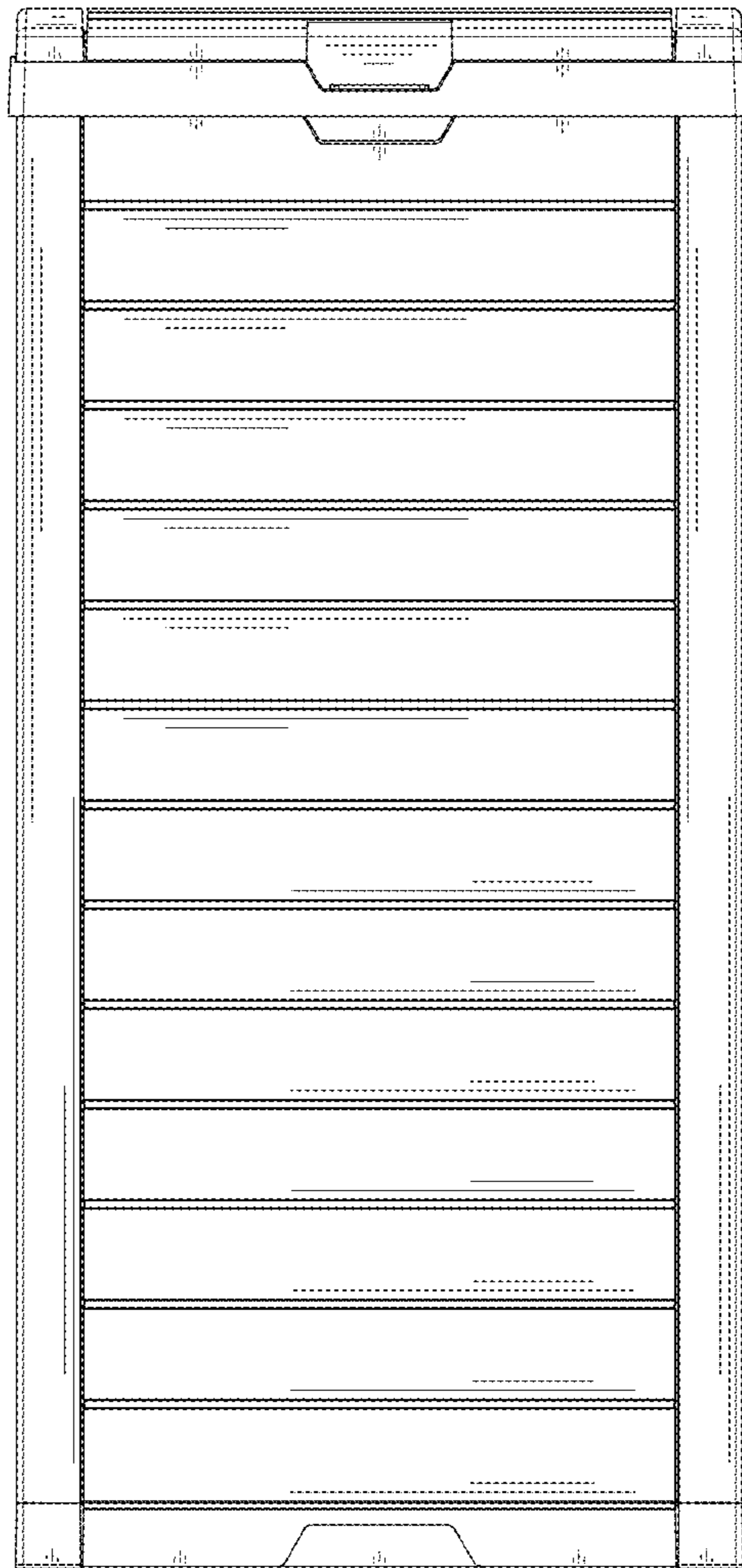

FIG. 3

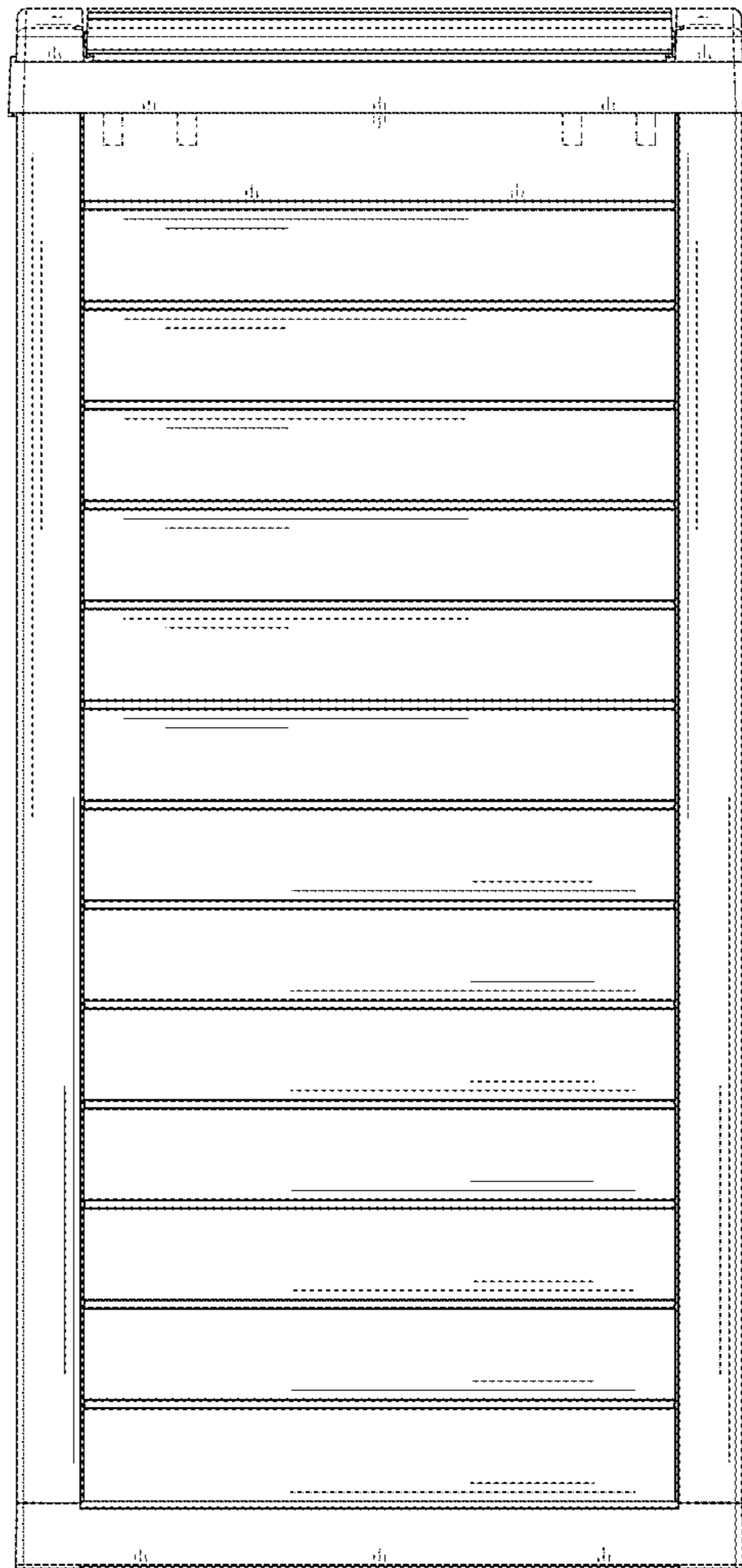

FIG. 4

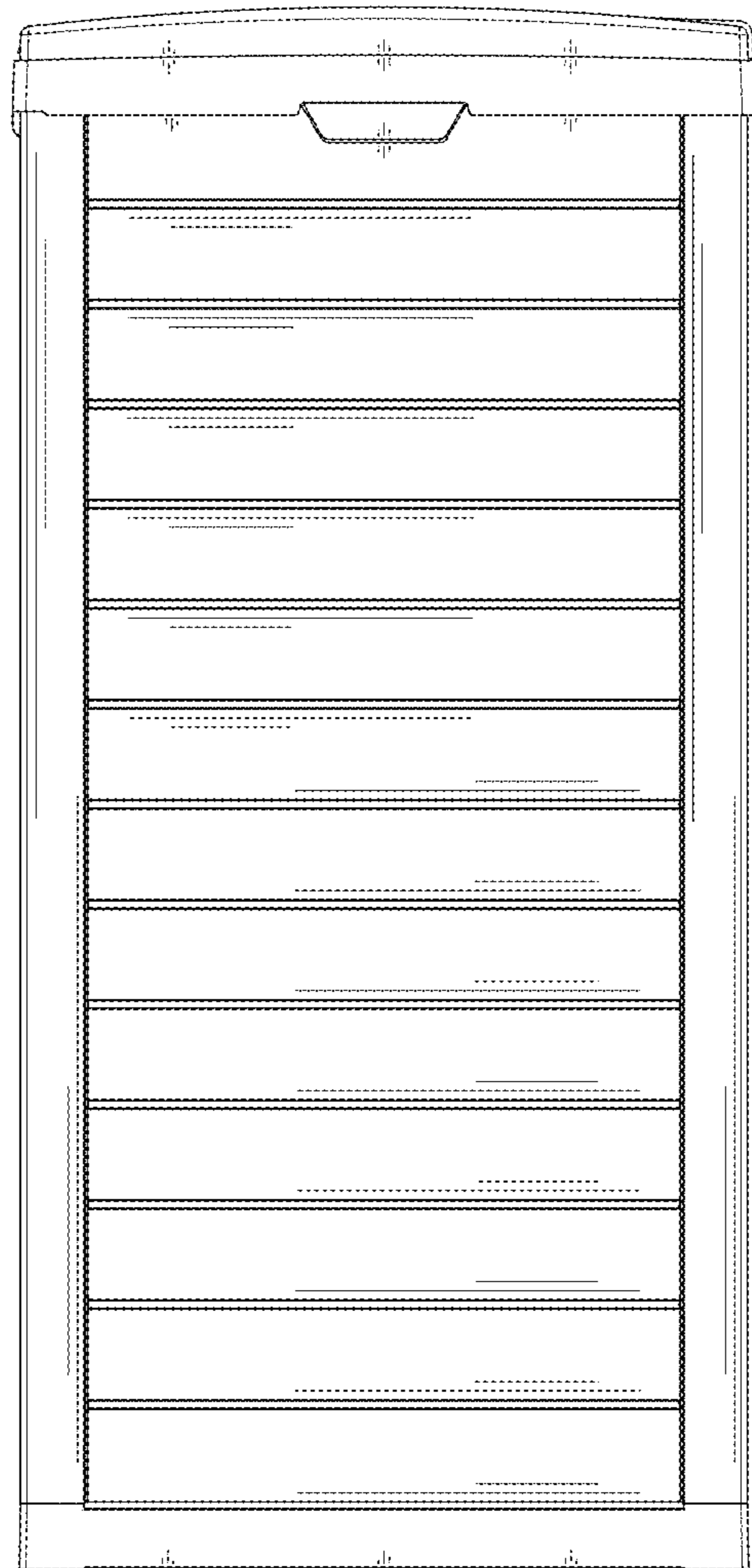

FIG. 5

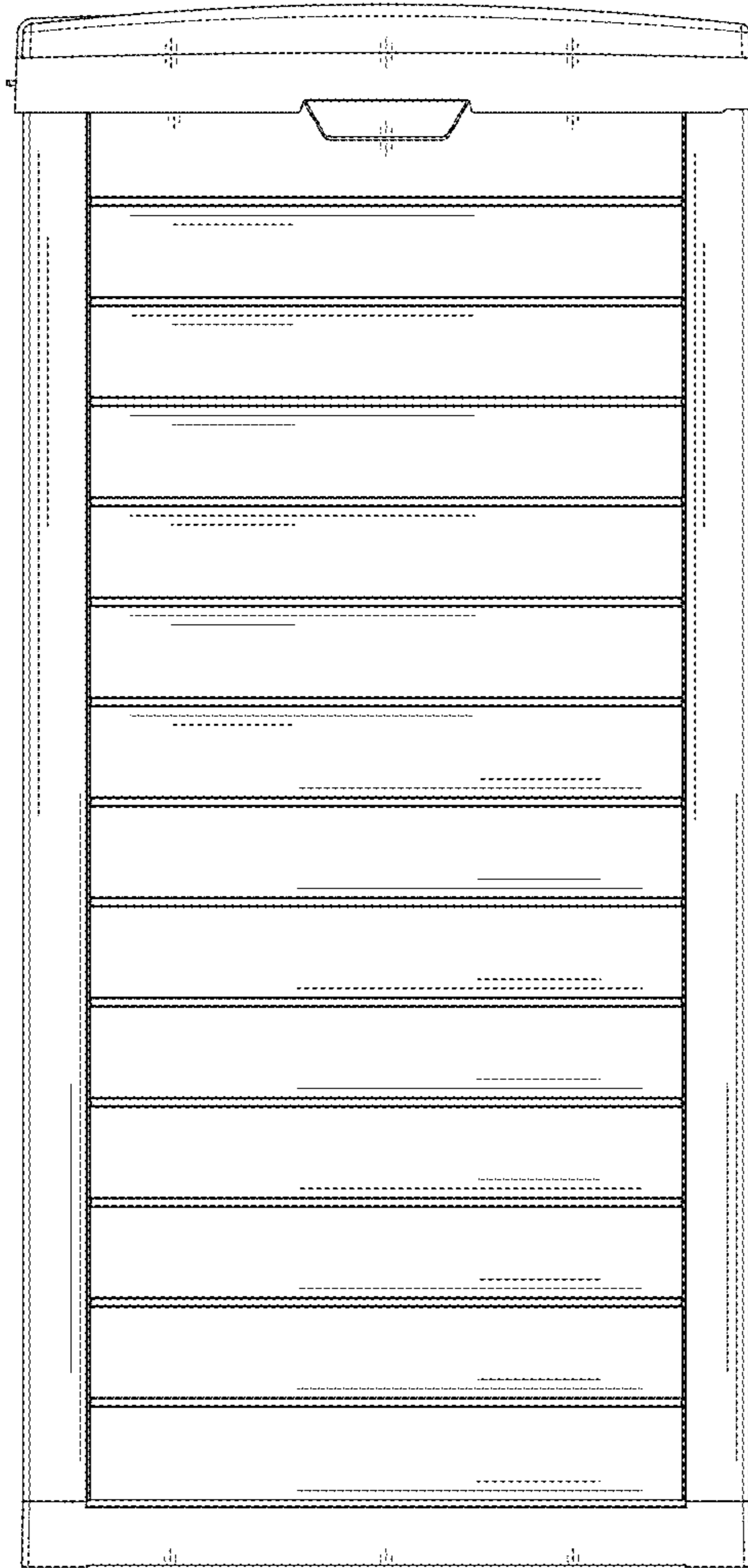

FIG. 6

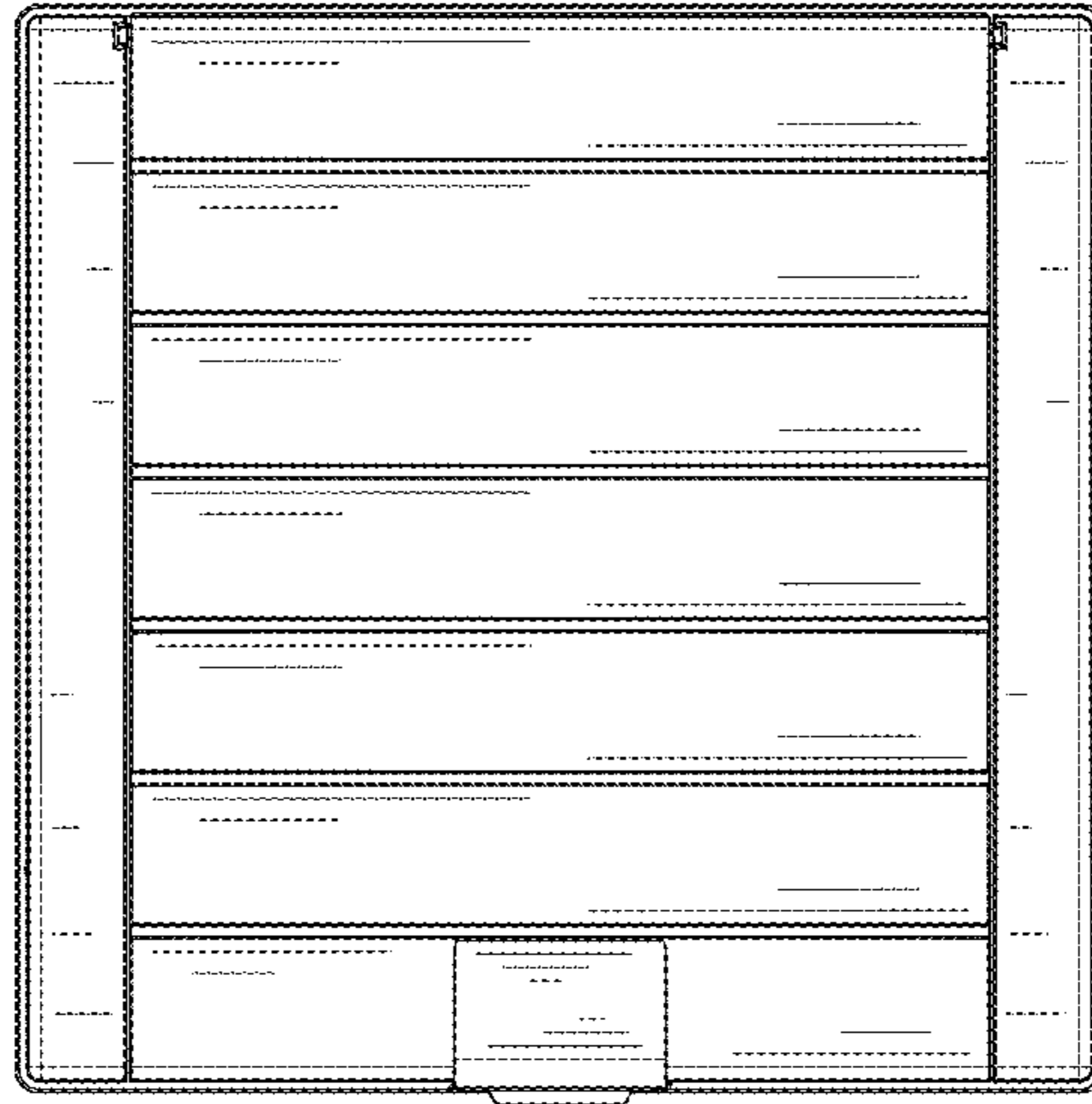

FIG. 7

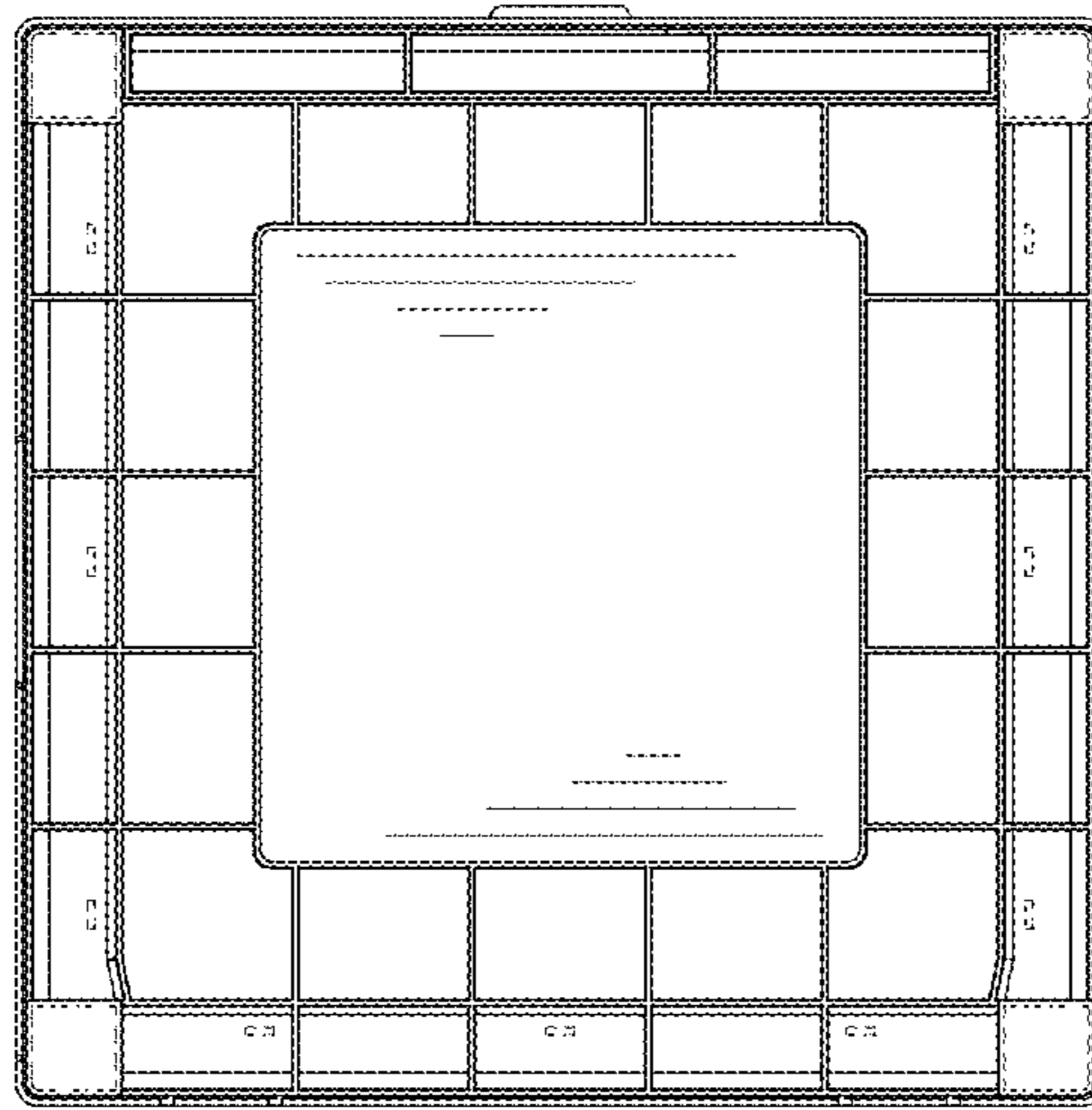

FIG. 8

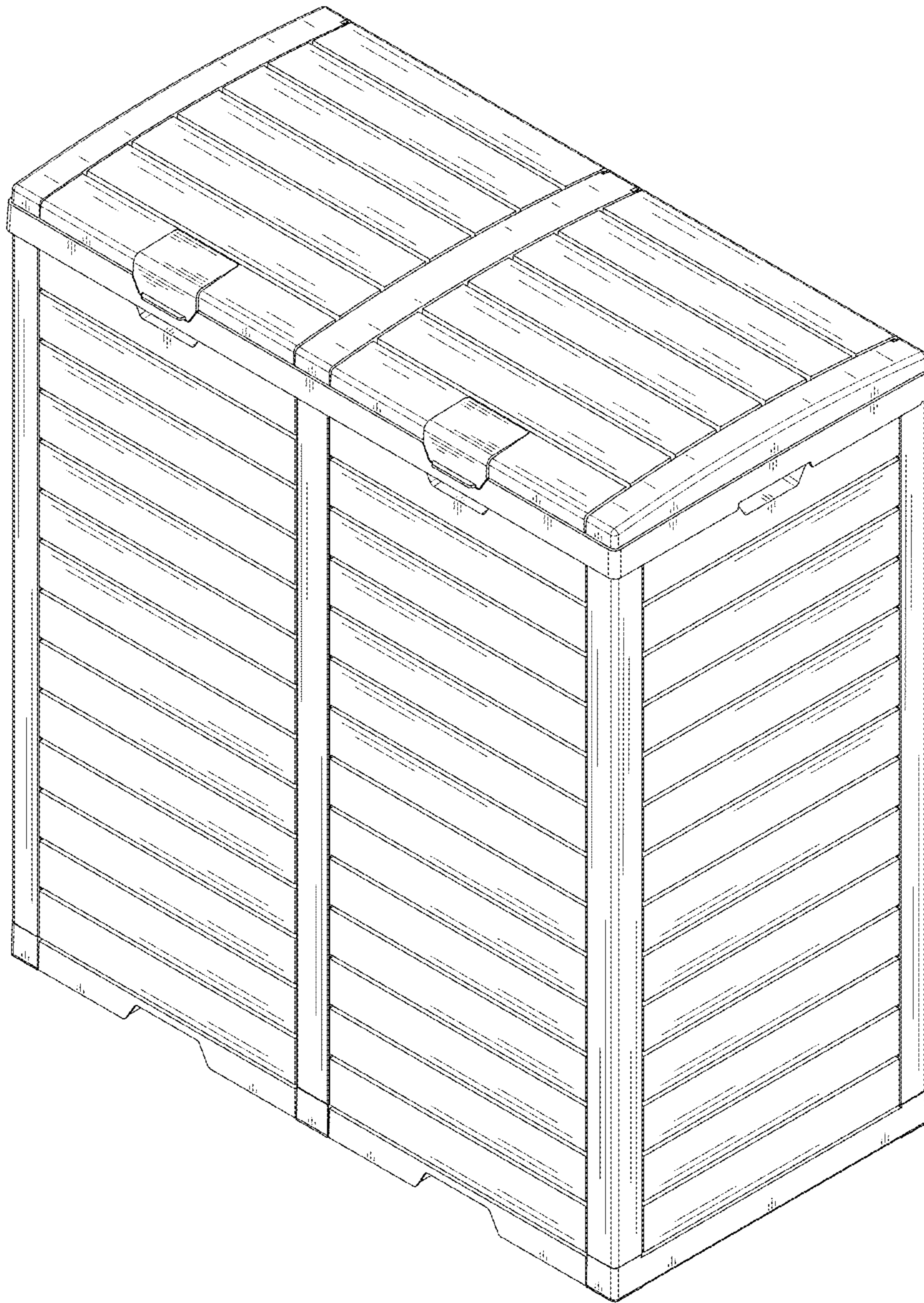

FIG. 9

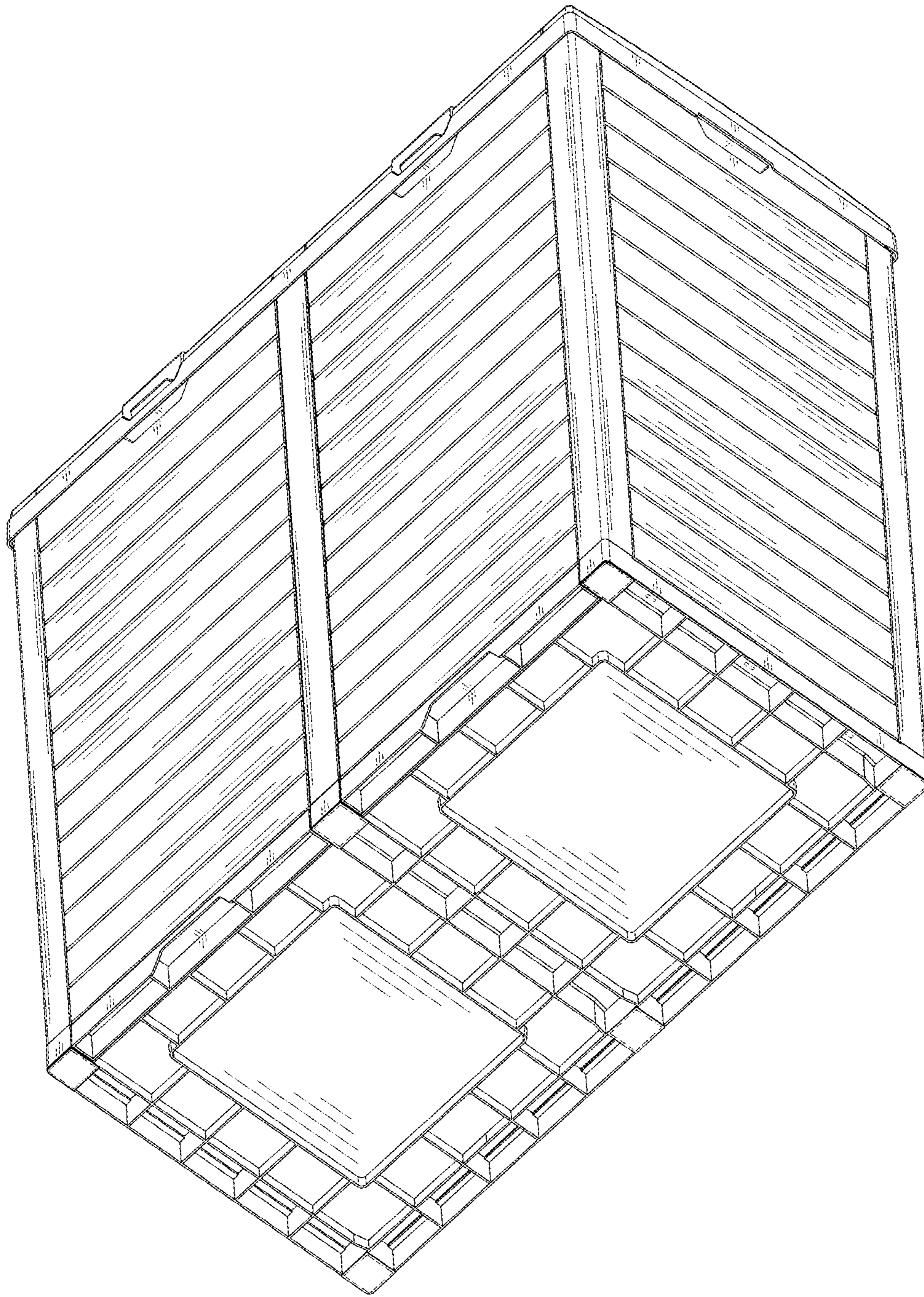

FIG. 10

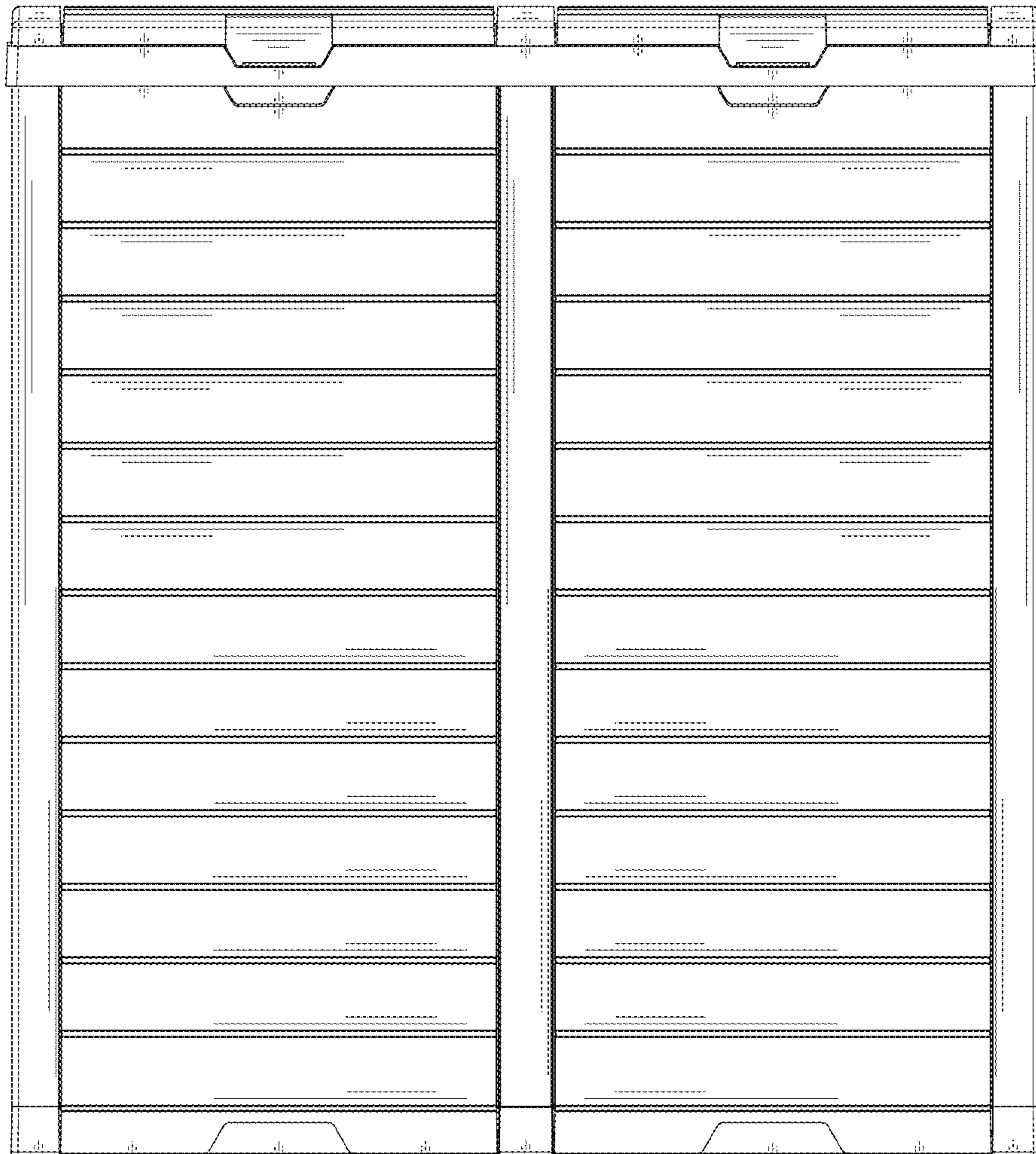

FIG. 11

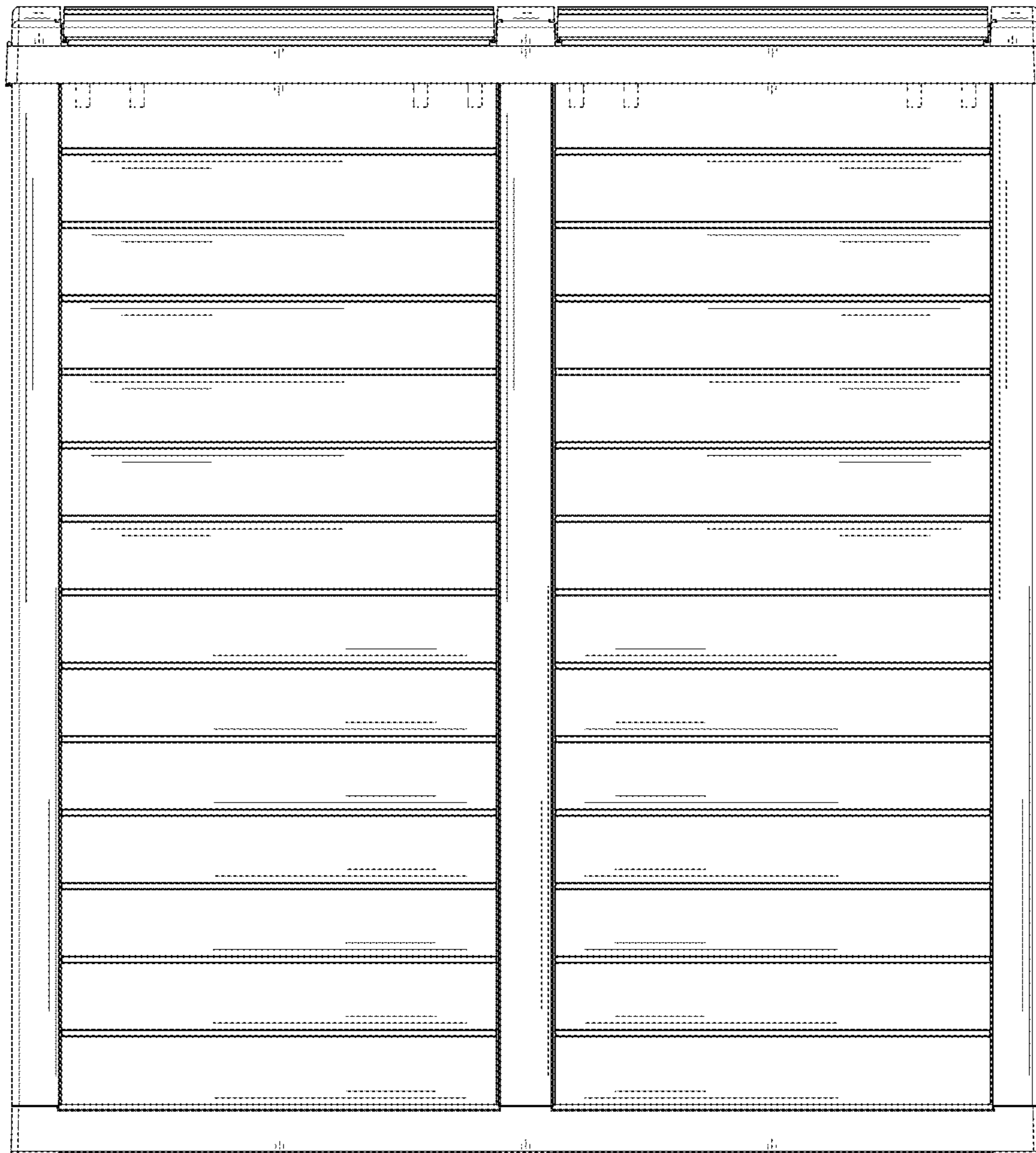

FIG. 12

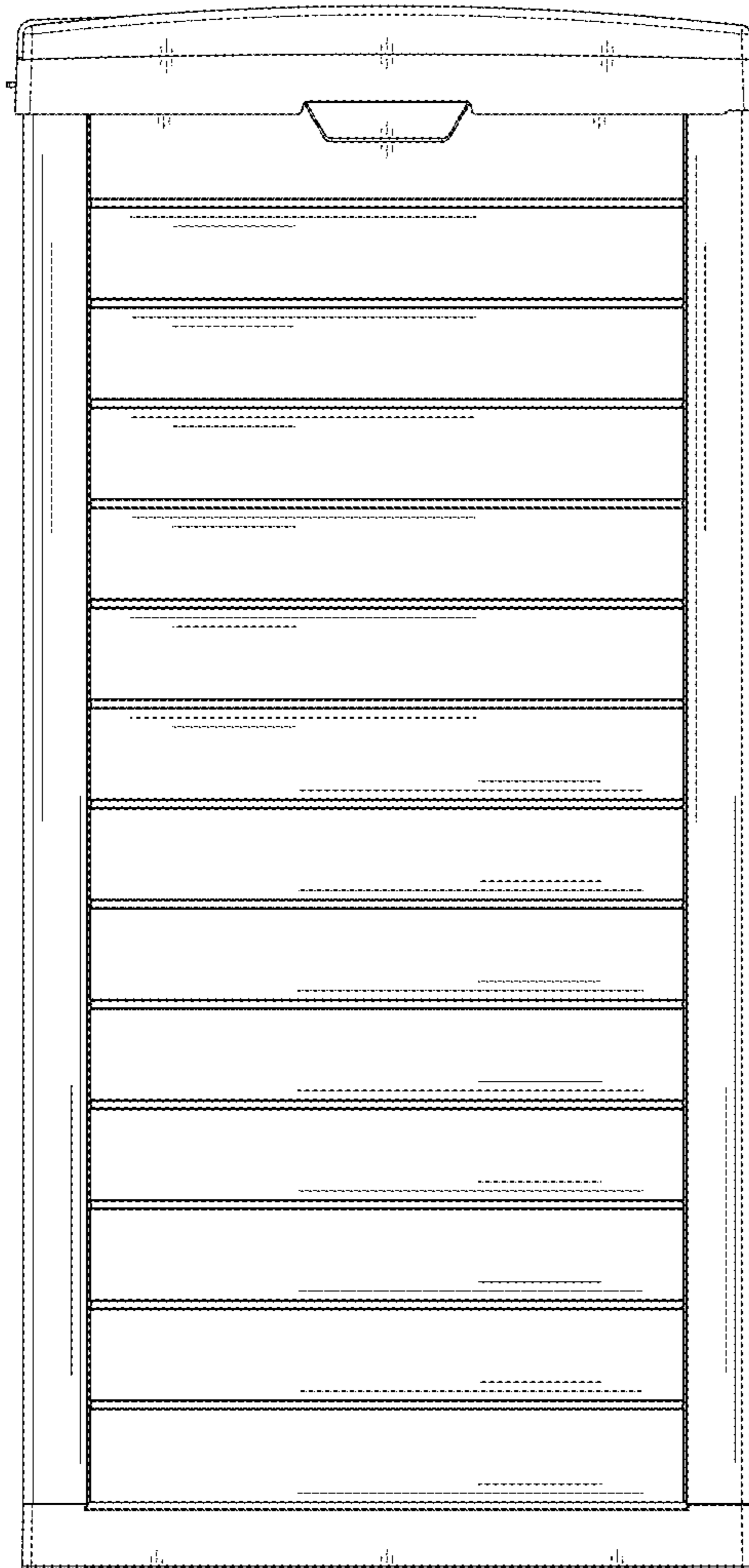

FIG. 13

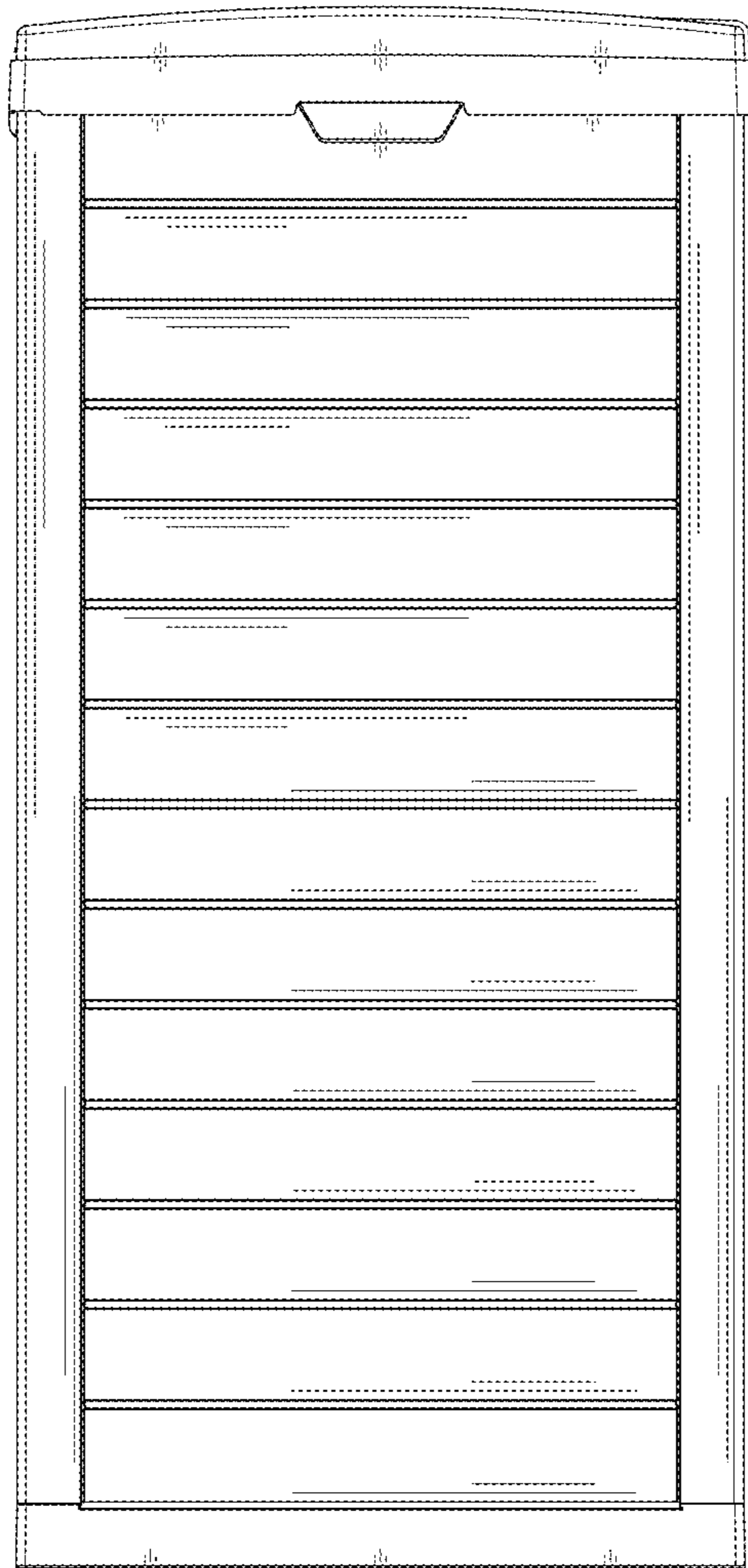

FIG. 14

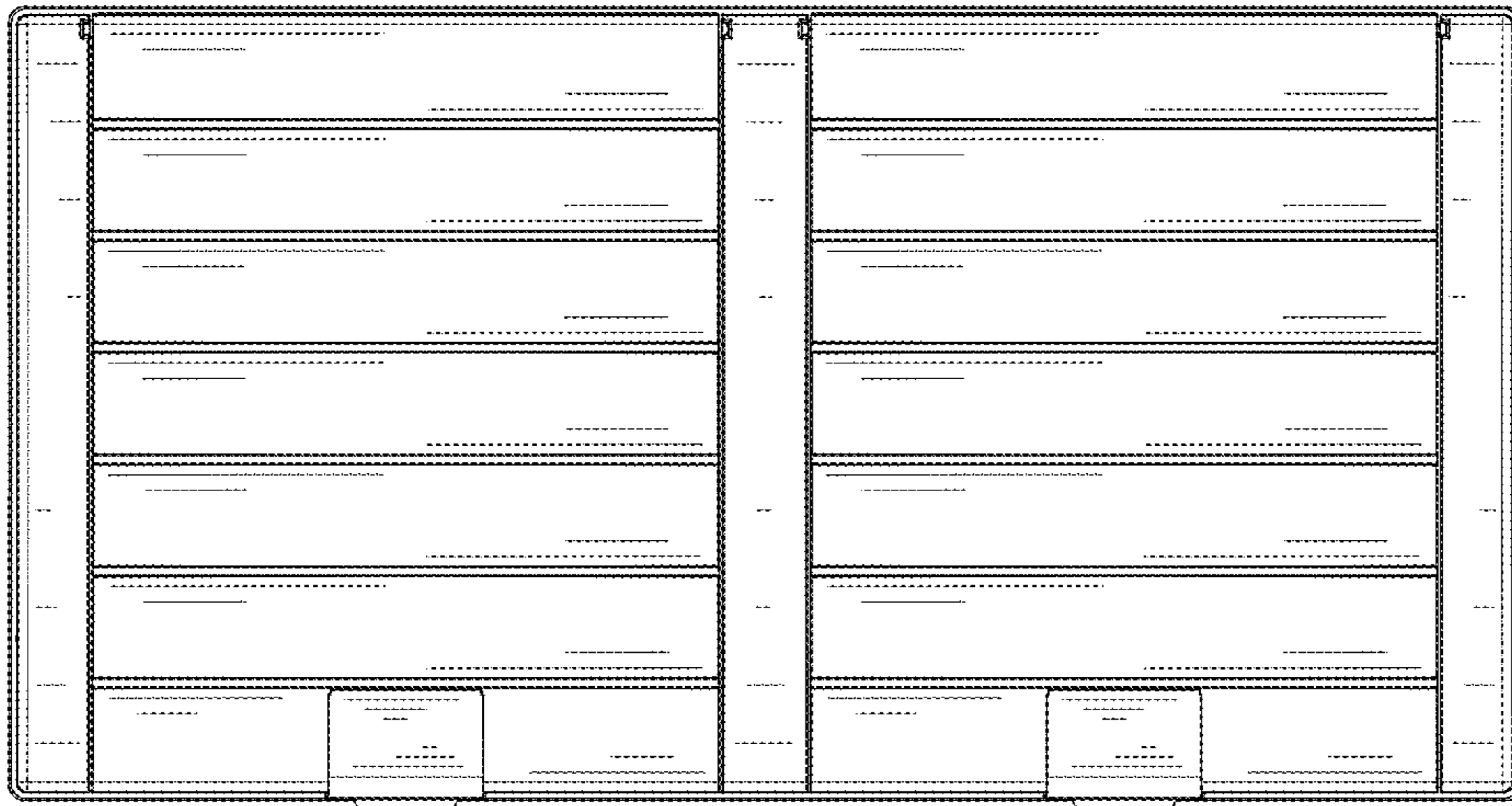

FIG. 15

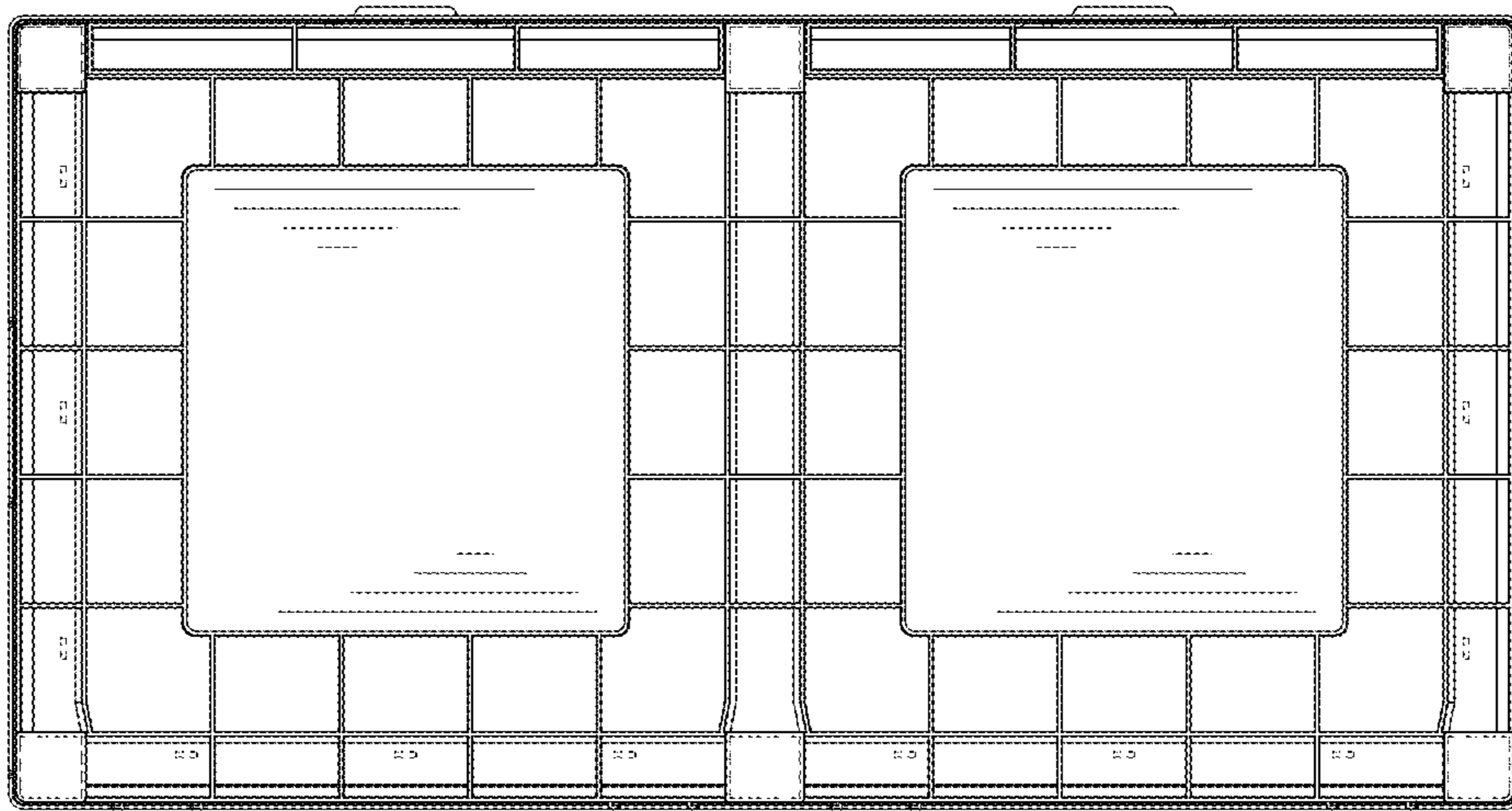

FIG. 16