



US00D971430S

(12) **United States Design Patent**
Nikitina et al.

(10) **Patent No.:** **US D971,430 S**

(45) **Date of Patent:** **** Nov. 29, 2022**

(54) **NOZZLE FOR A MASSAGE DEVICE**

(71) Applicant: **Obshhestvo s ogranichennoj
otvetsvennost'yu
EKONOMICHESKIYE
ELEKTRORESHENIYA**, Moscow
(RU)

(72) Inventors: **Maria Aleekseevna Nikitina**, Moscow
(RU); **Nikita Pavlovich Pelevin**,
Moscovskaya obl. (RU); **Denis
Aleekseevich Ledenkov**, Moscovskaya
obl. (RU)

(**) Term: **15 Years**

(21) Appl. No.: **35/512,643**

(22) Filed: **Apr. 22, 2021**

(80) **Hague Agreement Data**

Int. Filing Date: **Apr. 22, 2021**

Int. Reg. No.: **DM/216344**

Int. Reg. Date: **Apr. 22, 2021**

Int. Reg. Pub. Date: **Sep. 24, 2021**

(51) **LOC (13) Cl.** **24-01**

(52) **U.S. Cl.**
USPC **D24/215**

(58) **Field of Classification Search**
USPC D24/110, 164, 190, 200, 210, 211, 215,
D24/216
CPC A61H 23/02; A61H 2015/0014; A61M
31/007

See application file for complete search history.

(56) **References Cited**

U.S. PATENT DOCUMENTS

D706,440 S * 6/2014 Hahr D24/215
D706,441 S * 6/2014 Hahr D24/215

D820,466 S * 6/2018 Matsushita D24/215
D901,707 S * 11/2020 Meissner D24/215
D946,780 S * 3/2022 Liu D24/215
D949,395 S * 4/2022 Lee D24/215
D950,749 S * 5/2022 Lee D24/215
D953,555 S * 5/2022 Lee D24/215
D954,285 S * 6/2022 Lee D24/215
D963,186 S * 9/2022 Gasta D24/215
D963,190 S * 9/2022 Gasta D24/215

OTHER PUBLICATIONS

“Better Angel Acupuncture Pen Electronic Acupuncture Pen Mas-
sager Pen Acupuncture Pen Trigger Point Back Pain Relief, Electric
Meridian Energy Acupuncture Pen Therapy Pen Electro Acupunc-
ture Device” [online]. Better Angel. [Product first avaiable on Jul.
7, 2021]. Retrieved from the Internet: <[https://www.amazon.com/
dp/B098SYZQS1](https://www.amazon.com/dp/B098SYZQS1)>.*

* cited by examiner

Primary Examiner — Mojtaba Tehrani

(57) **CLAIM**

The ornamental design for a nozzle for massage device, as
shown and described.

DESCRIPTION

1. Nozzle for a massage device

1.1 : Perspective

1.2 : Perspective

1.3 : Top

1.4 : Left

1.5 : Bottom

1.6 : Front

1.7 : Back

The nozzle for massage device which has a cylindrical body
with a hollow that contains a roller with spherical massage
elements, a display screen, a convex front edge with a button,
and a handle with joystick button in the back.

1 Claim, 7 Drawing Sheets

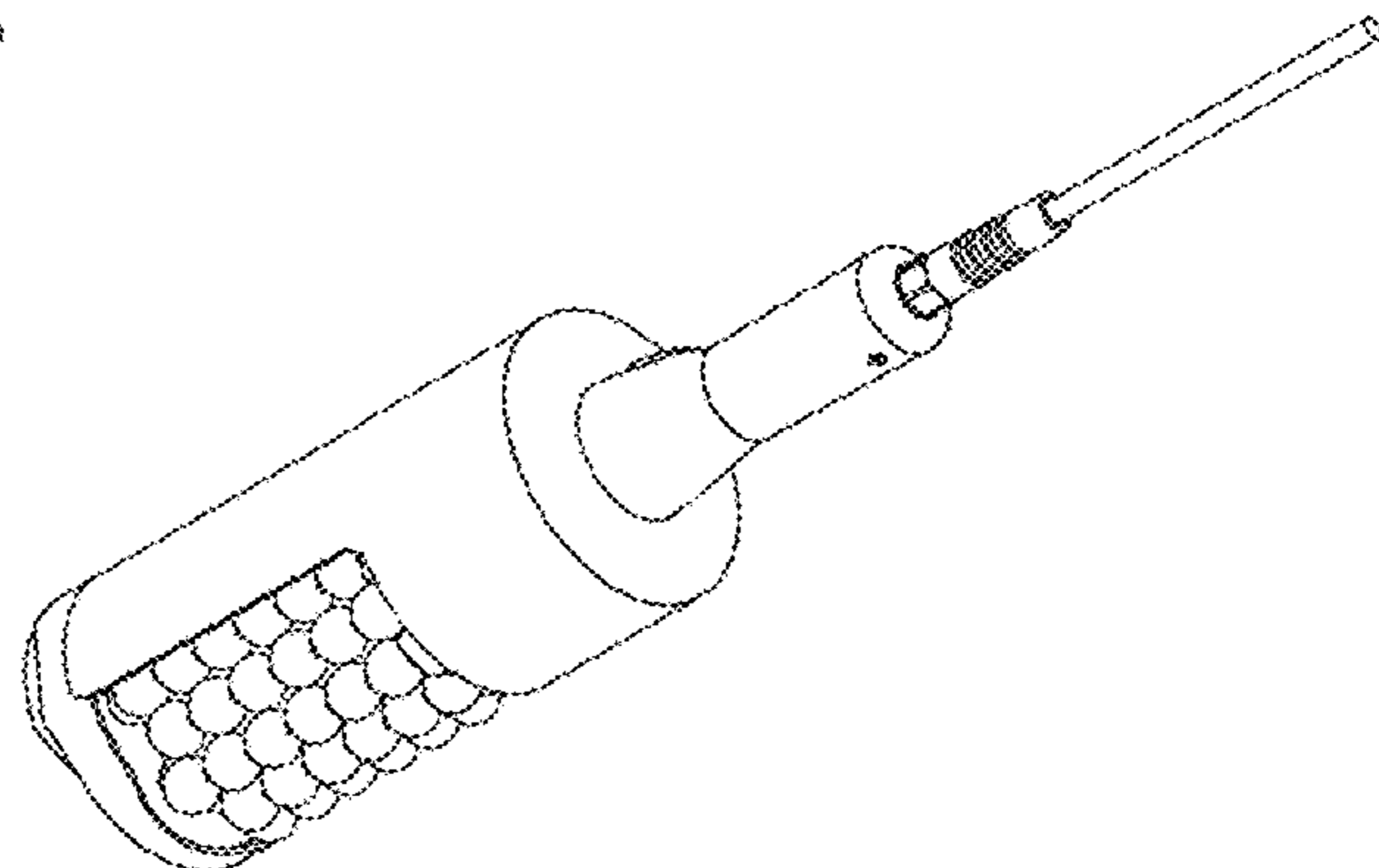
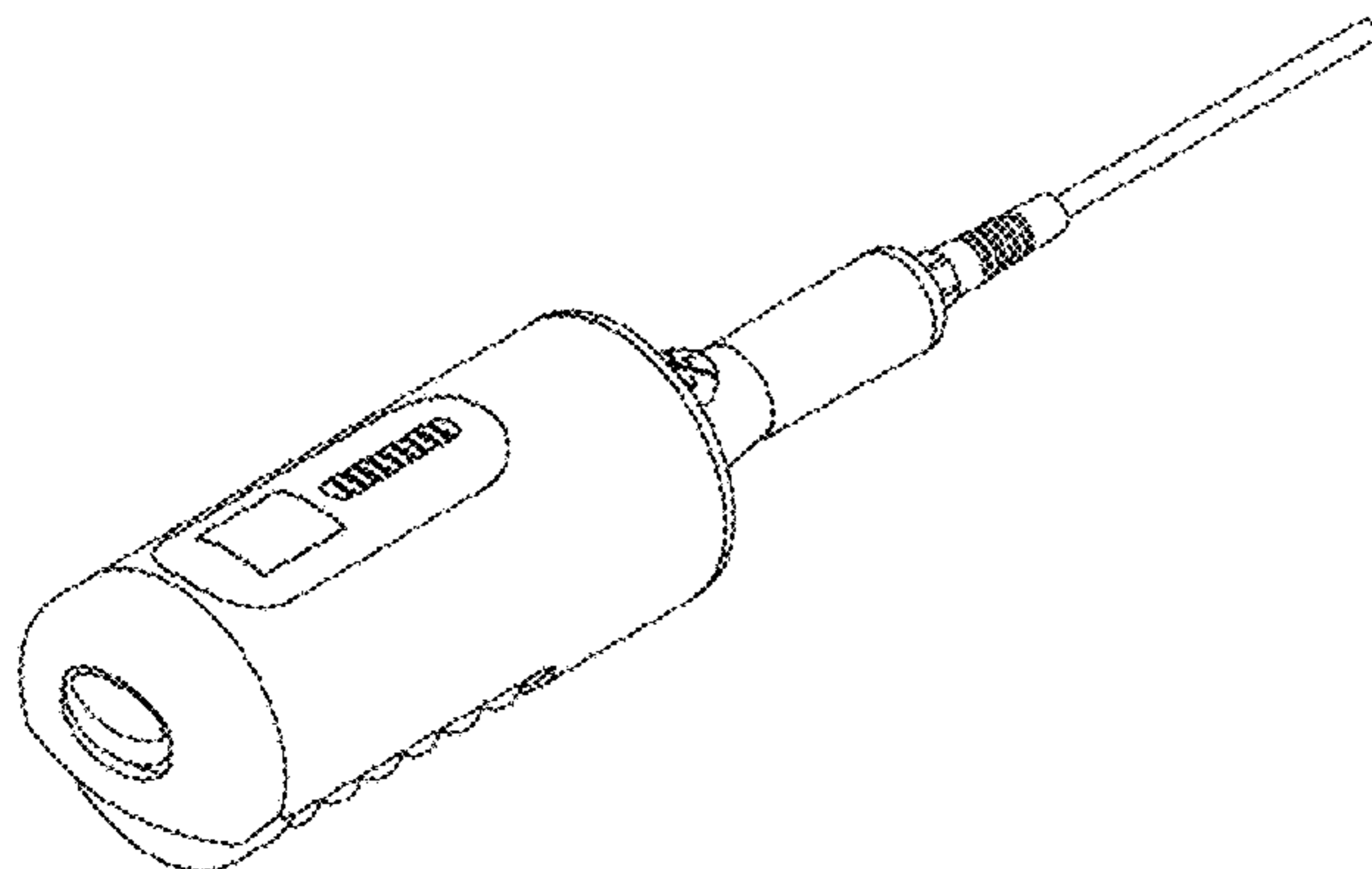

1.1

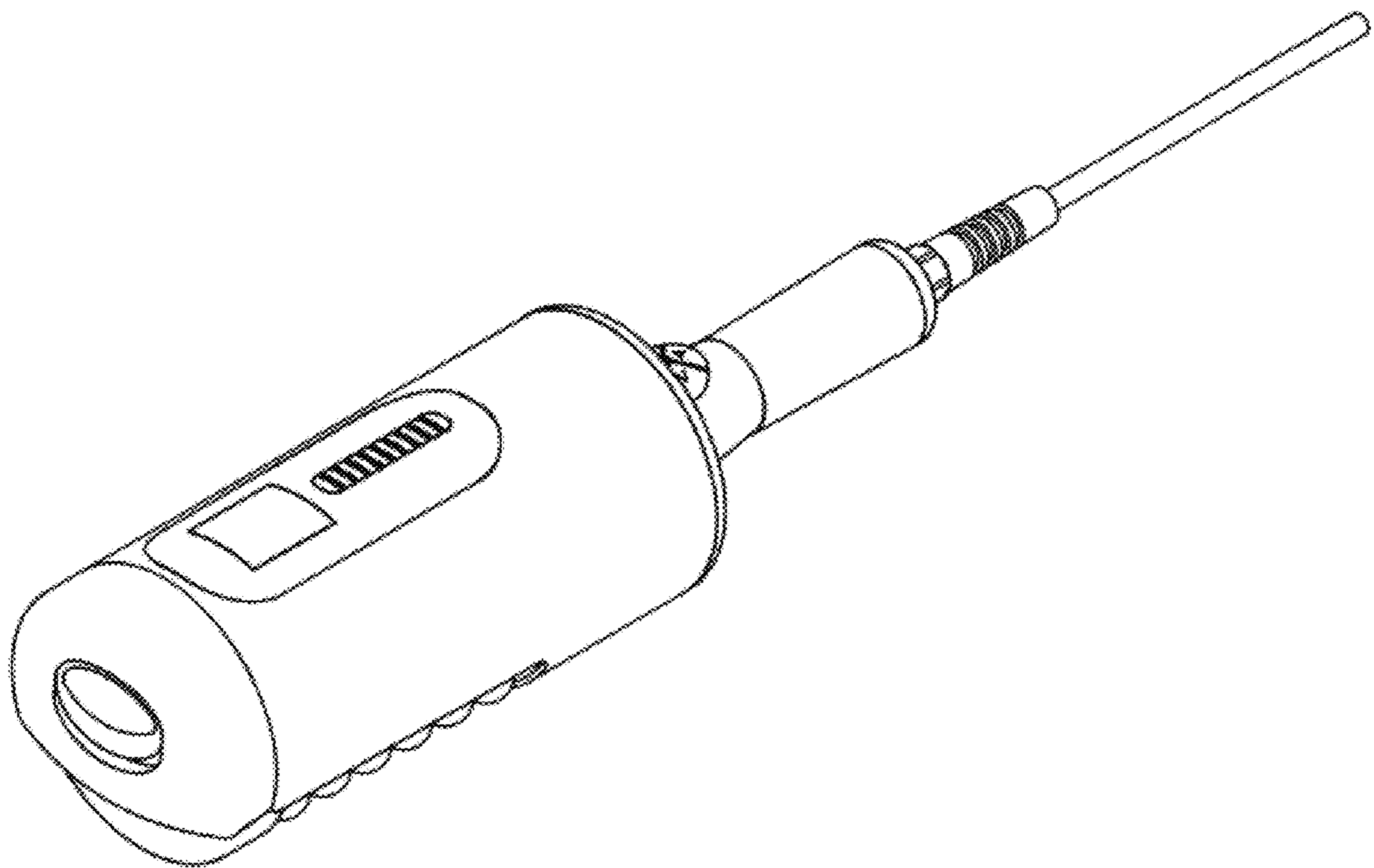

1.2

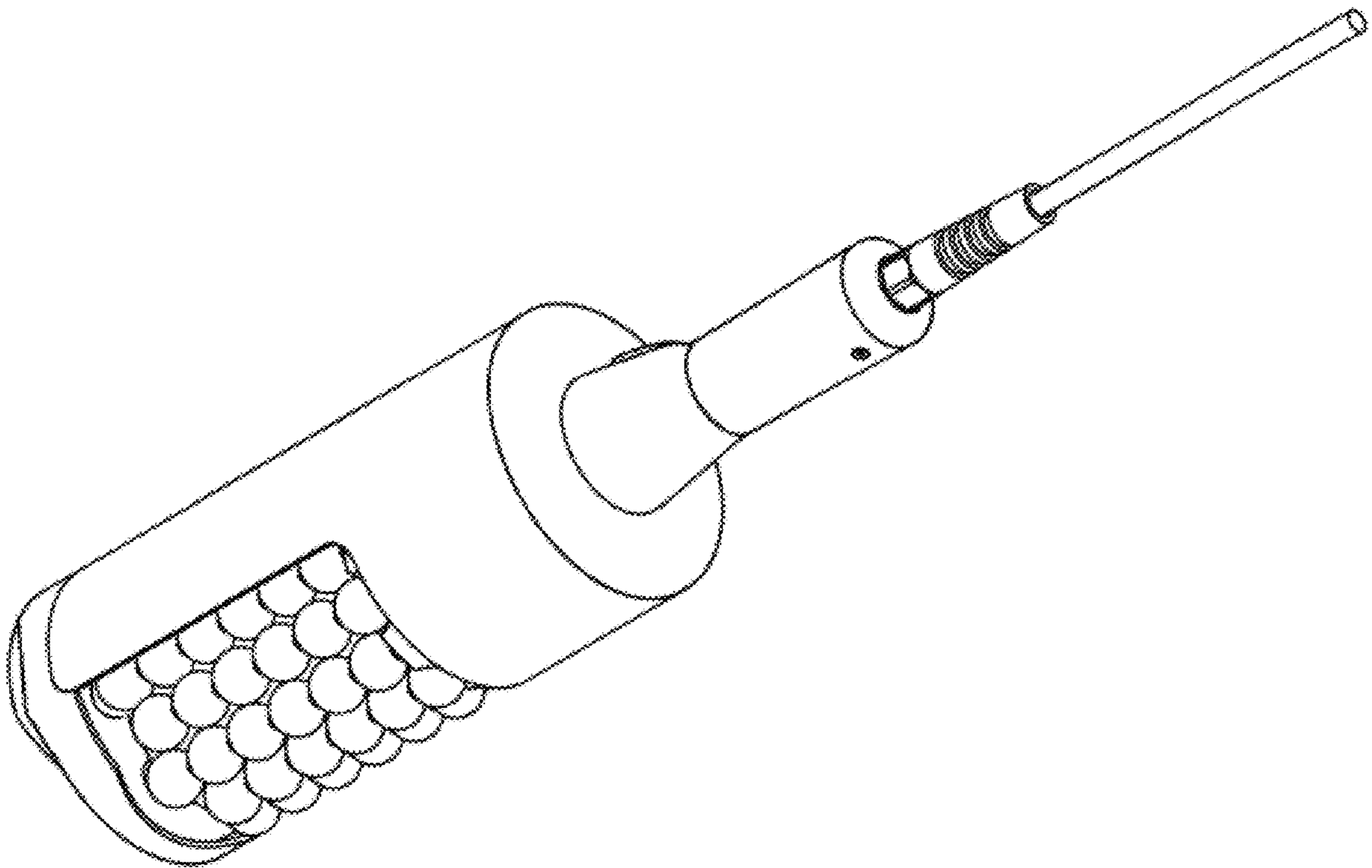

1.3

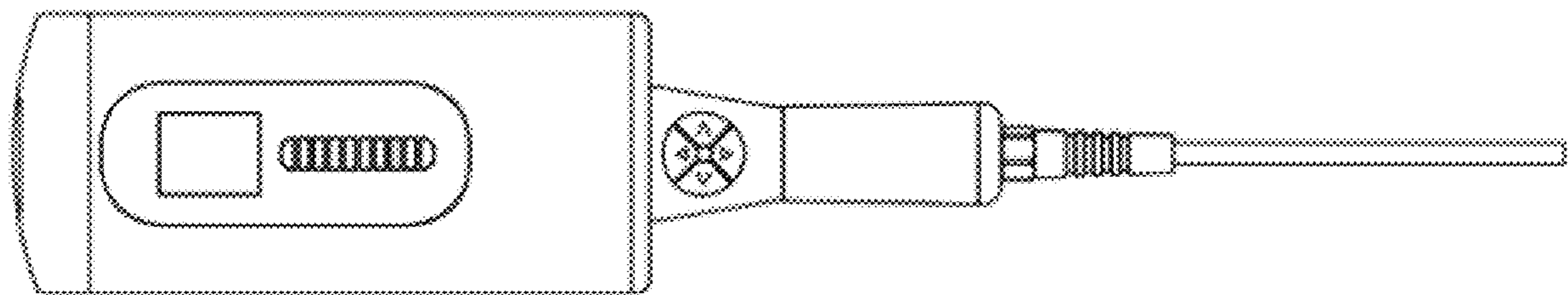

1.4

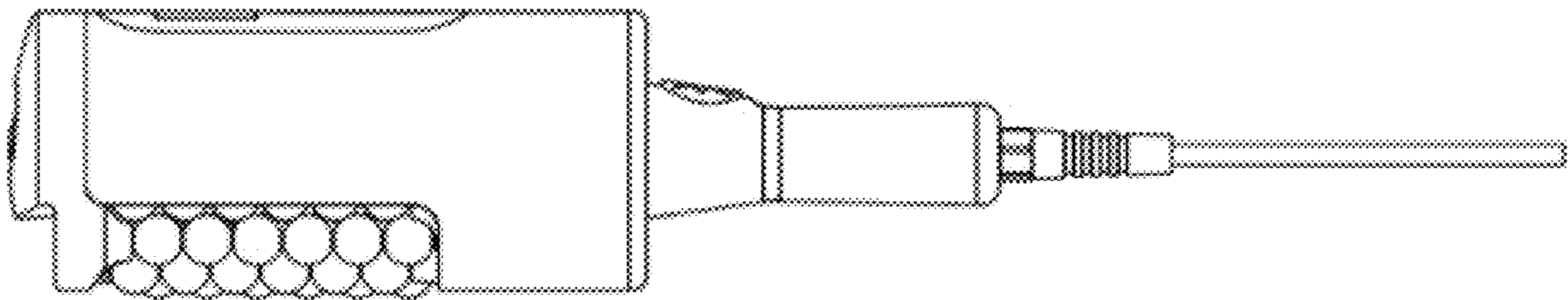

1.5

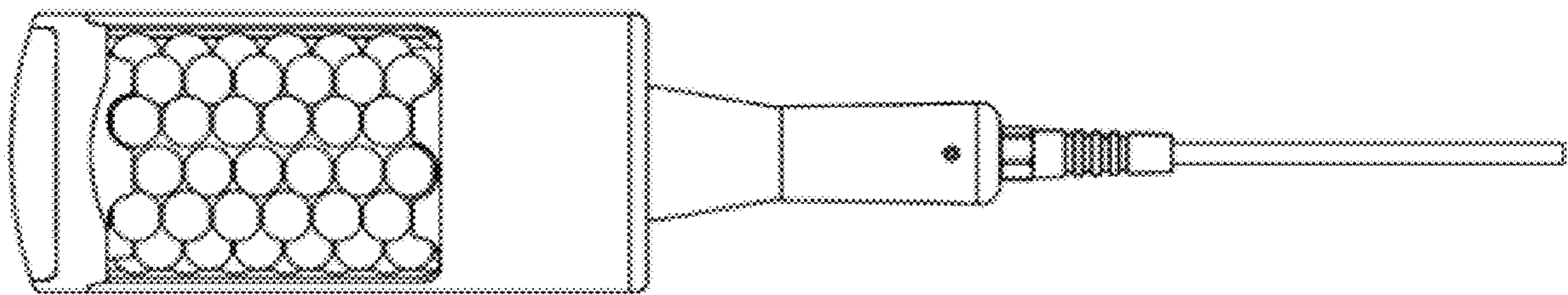

1.6

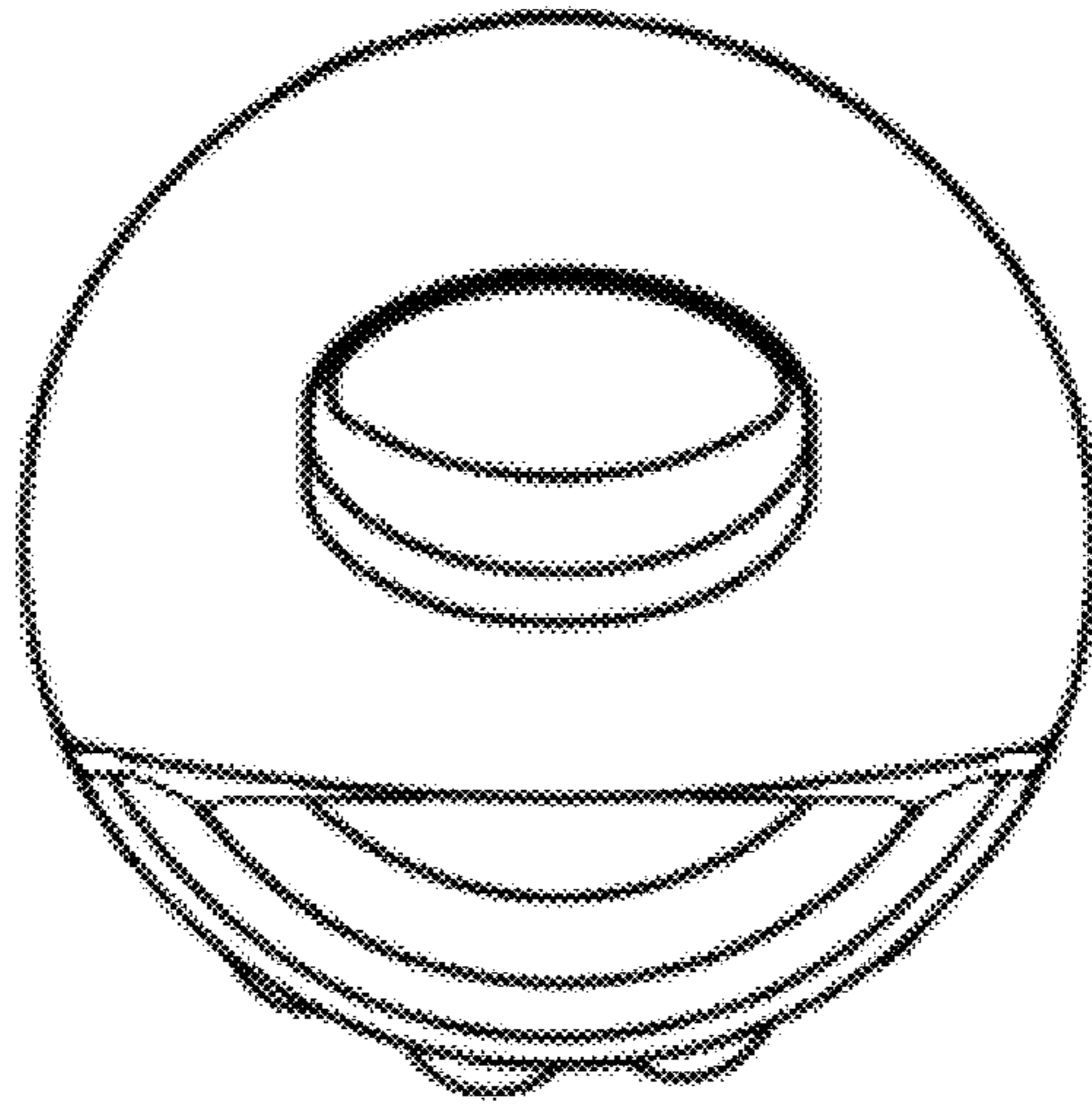

1.7

