



US00D971410S

(12) **United States Design Patent** (10) **Patent No.:** **US D971,410 S**
Leither et al. (45) **Date of Patent:** **** Nov. 29, 2022**

(54) **ORTHOPEdic PLATE**

(71) Applicant: **ORTHO SOLUTIONS HOLDINGS LIMITED**, Littleton, CO (US)

(72) Inventors: **Andrew Leither**, Akron, OH (US);
Dustin Ducharme, Littleton, CO (US)

(73) Assignee: **ORTHO SOLUTIONS HOLDINGS LIMITED**, Littleton, CO (US)

(**) Term: **15 Years**

(21) Appl. No.: **29/782,603**

(22) Filed: **May 7, 2021**

(51) **LOC (13) Cl.** **24-03**

(52) **U.S. Cl.**
USPC **D24/155**

(58) **Field of Classification Search**
USPC D24/155
CPC A61B 17/8061; A61B 17/7059; A61B 17/8052; A61B 17/8605; A61B 17/8085; A61B 17/809; A61B 17/8014; A61B 17/8033; A61B 17/8004; A61B 17/888; A61B 17/842; A61B 17/8023; A61B 17/8009; A61B 17/86; A61B 17/1739; A61B 17/8066; A61B 17/1671; A61B 17/1757; A61B 17/8071; A61B 17/176

See application file for complete search history.

(56) **References Cited**

U.S. PATENT DOCUMENTS

D505,205 S *	5/2005	Freid	D24/155
D623,743 S *	9/2010	Den Hartog	D24/155
D643,927 S *	8/2011	Prasad	D24/155
D740,943 S *	10/2015	Neufeld	A61B 17/8061
				D24/155
D766,437 S *	9/2016	DaCosta	D24/155
D766,438 S *	9/2016	DaCosta	D24/155
D766,439 S *	9/2016	DaCosta	D24/155

(Continued)

Primary Examiner — Charles D Hanson

(74) *Attorney, Agent, or Firm* — Hudak, Shunk & Farine Co. LPA

(57) **CLAIM**

The ornamental design for an “orthopedic plate,” as shown and described.

DESCRIPTION

FIG. 1 is a right top perspective view of a first embodiment of an orthopedic plate comprising a left plate wherein the right plate is a mirror image of the left plate, showing my new design;

FIG. 2 is a first side view thereof;

FIG. 3 is a second side view thereof;

FIG. 4 is a first end view thereof;

FIG. 5 is a second end view thereof;

FIG. 6 is a top view thereof;

FIG. 7 is a bottom view thereof;

FIG. 8 is a right top perspective view of a second embodiment of an orthopedic plate comprising a right plate wherein the left plate is a mirror image of the right plate, showing my new design;

FIG. 9 is a first side view thereof;

FIG. 10 is a second side view thereof;

FIG. 11 is a first end view thereof;

FIG. 12 is a second end view thereof;

FIG. 13 is a top view thereof;

FIG. 14 is a bottom view thereof;

FIG. 15 is a right top perspective view of a third embodiment of an orthopedic plate comprising a right plate wherein the left plate is a mirror image of the right plate, showing my new design;

FIG. 16 is a first side view thereof;

FIG. 17 is a second side view thereof;

FIG. 18 is a first end view thereof;

FIG. 19 is a second end view thereof;

FIG. 20 is a top view thereof; and,

FIG. 21 is a bottom view thereof.

1 Claim, 7 Drawing Sheets

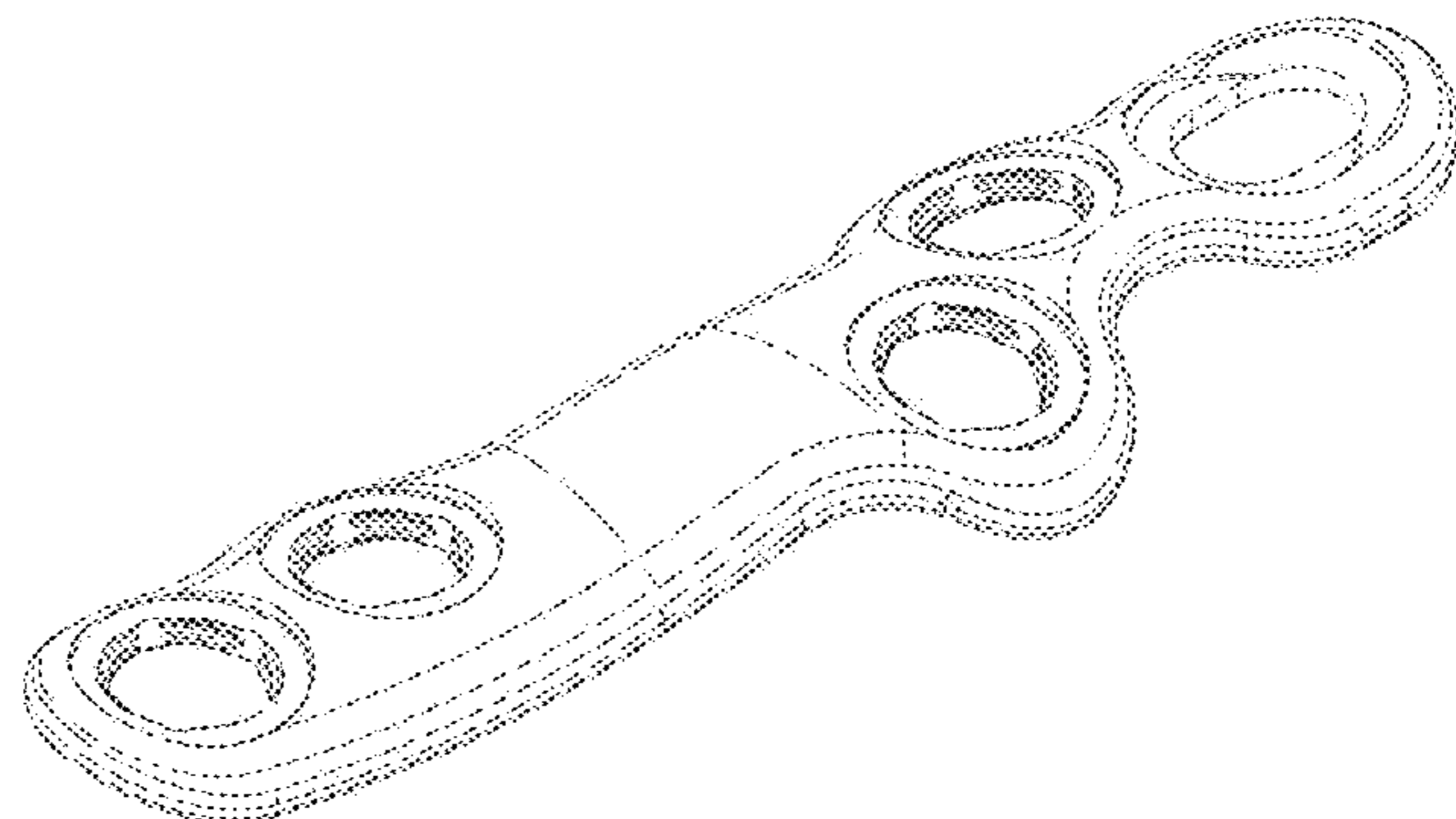
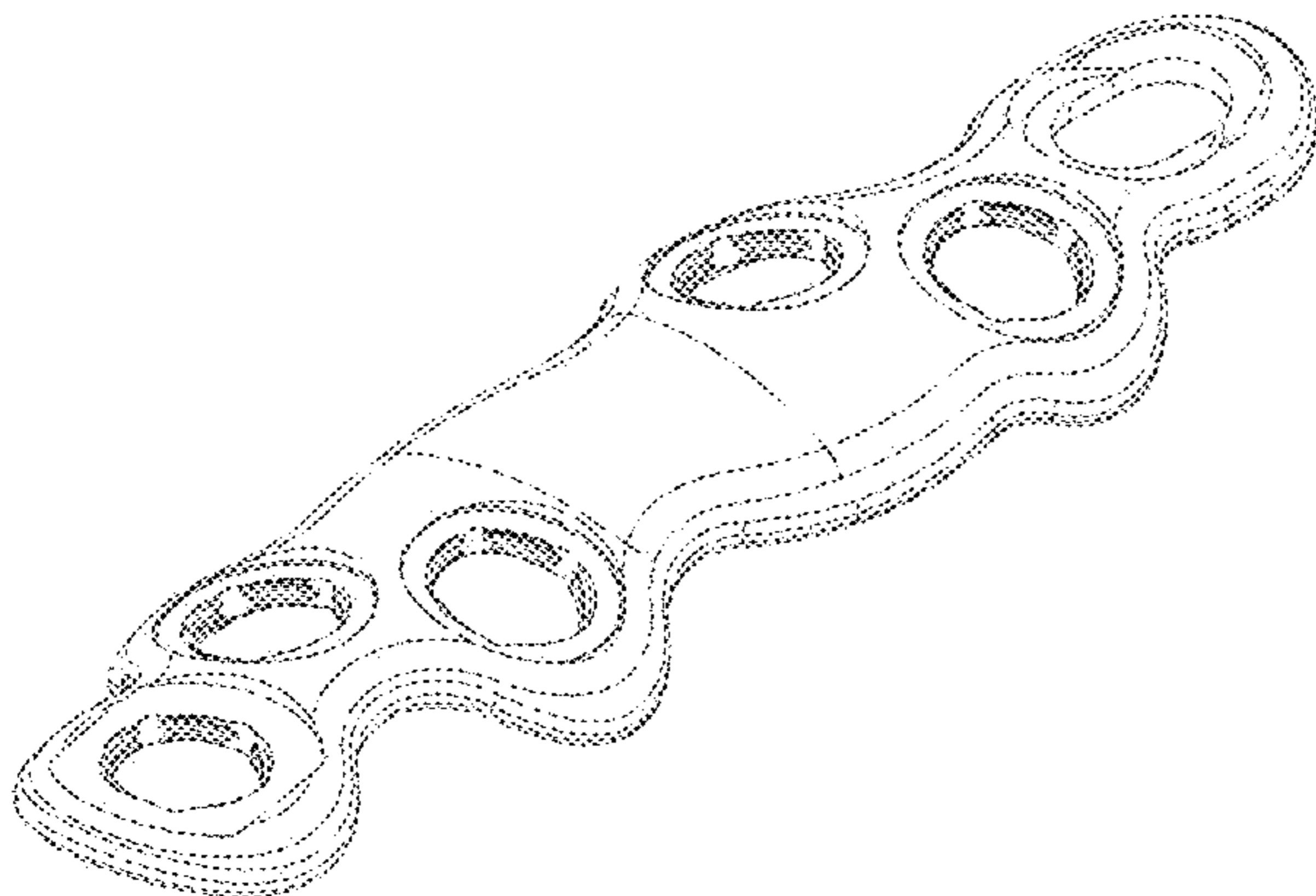

(56)

References Cited

U.S. PATENT DOCUMENTS

D780,924	S	*	3/2017	DaCosta	D24/155
D780,925	S	*	3/2017	DaCosta	D24/155
D780,926	S	*	3/2017	DaCosta	D24/155
D785,798	S	*	5/2017	Kohler	D24/155
D786,435	S	*	5/2017	Kohler	D24/155
D814,635	S	*	4/2018	Asfora	D24/155
D829,910	S	*	10/2018	Horton	D24/155
D877,905	S	*	3/2020	Linder	D24/155
D928,322	S	*	8/2021	Mason	D24/155

* cited by examiner

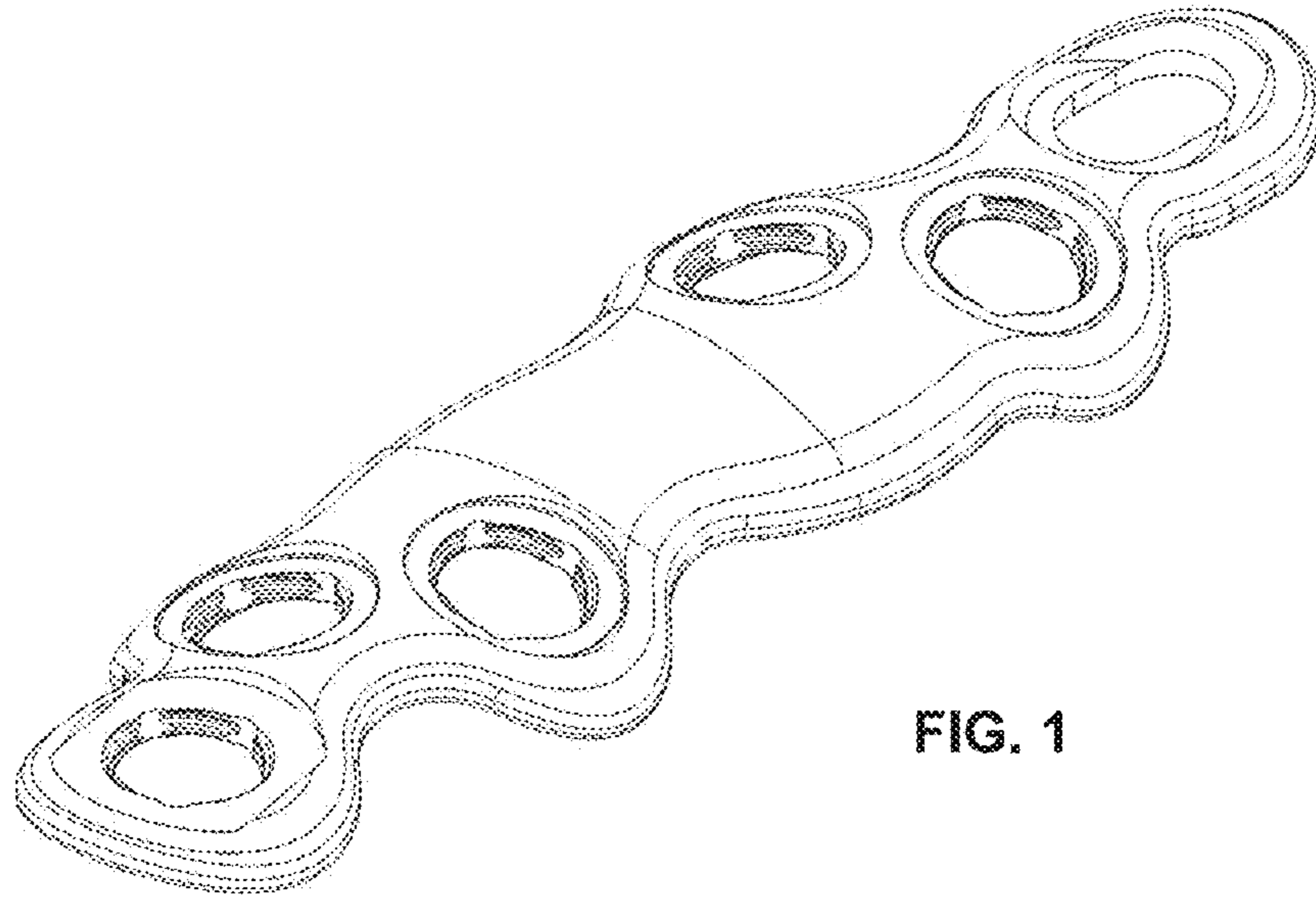

FIG. 1

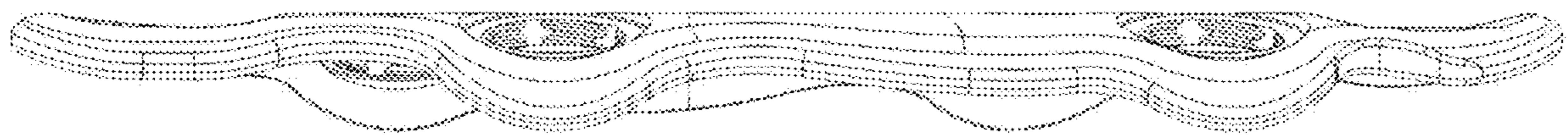

FIG. 2

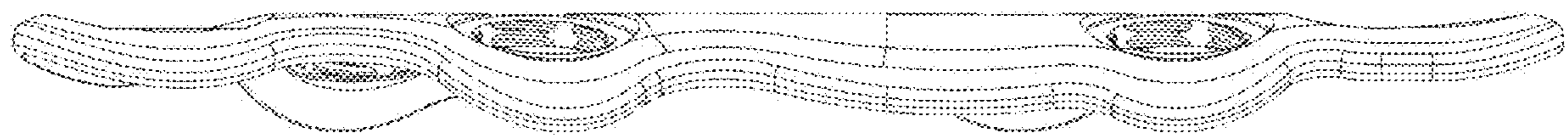

FIG. 3

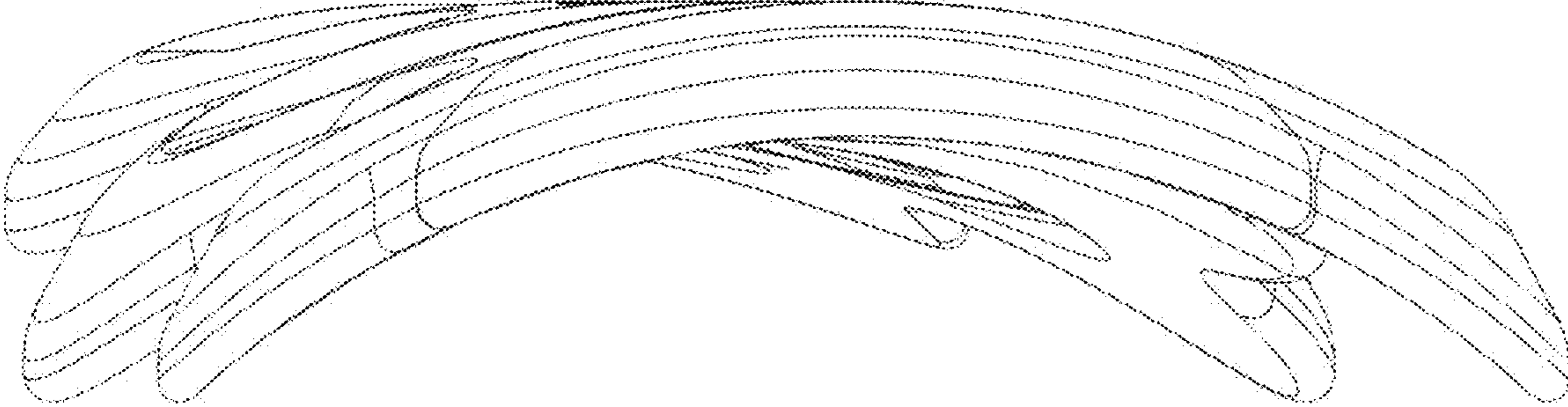

FIG. 4

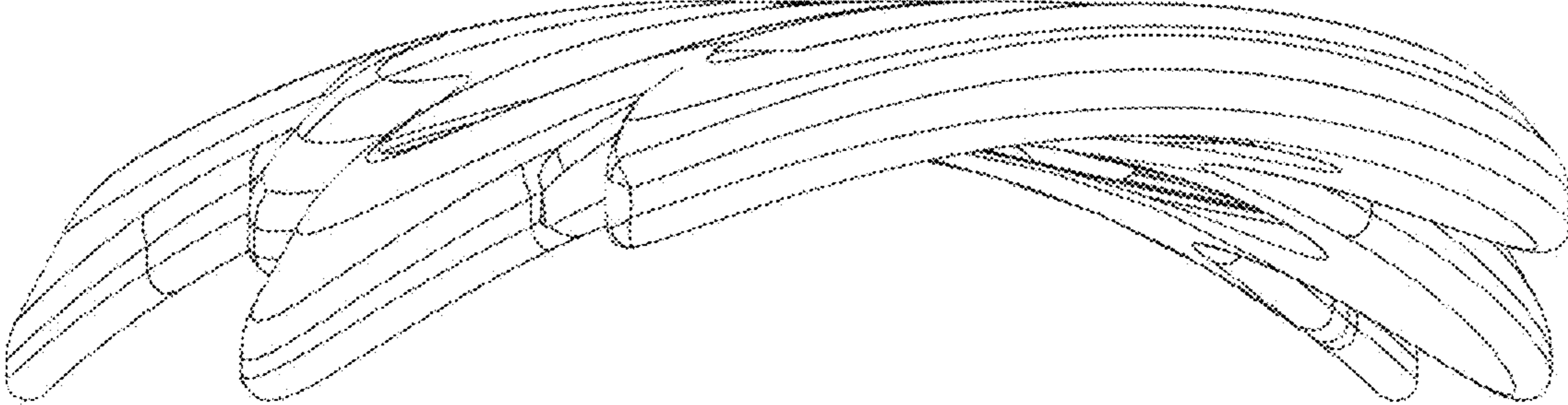

FIG. 5

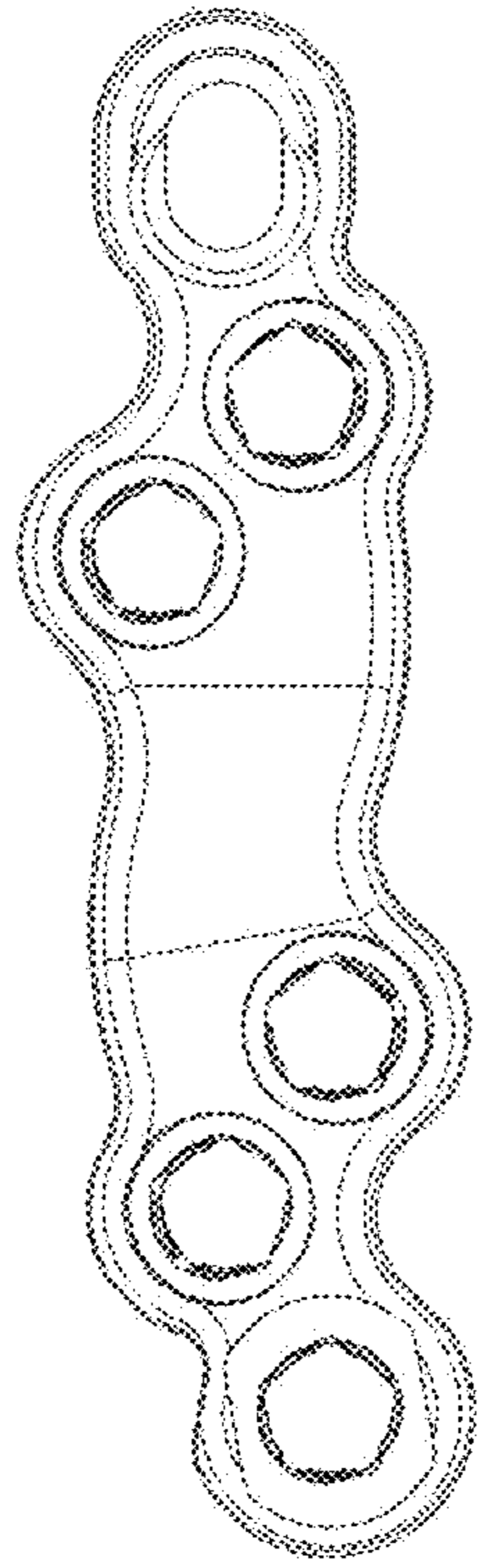

FIG. 6

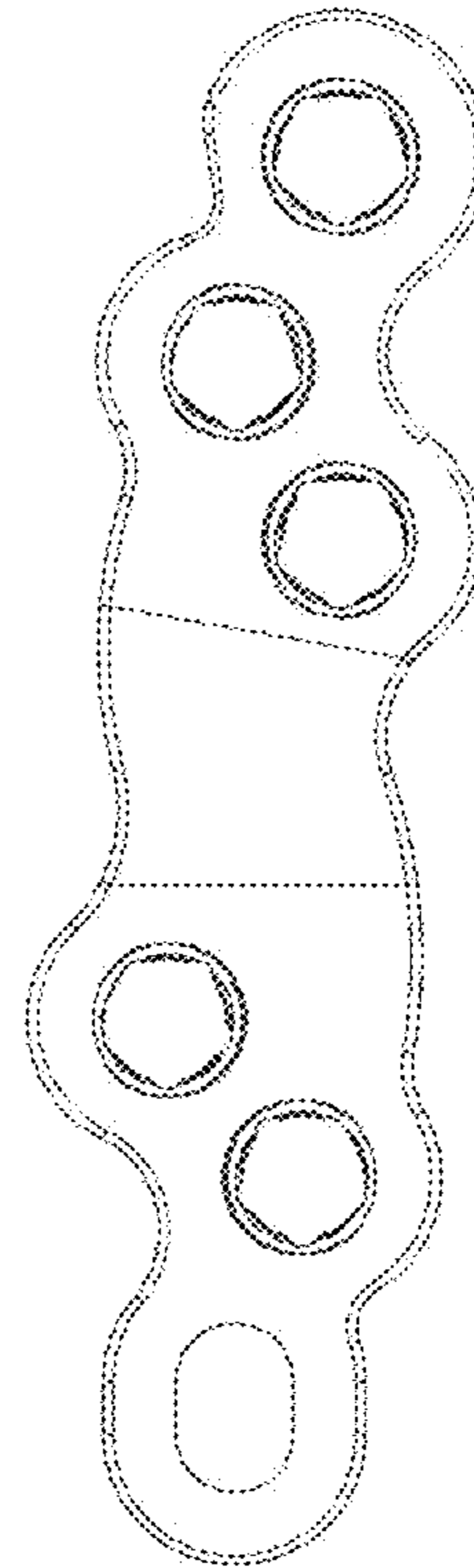

FIG. 7

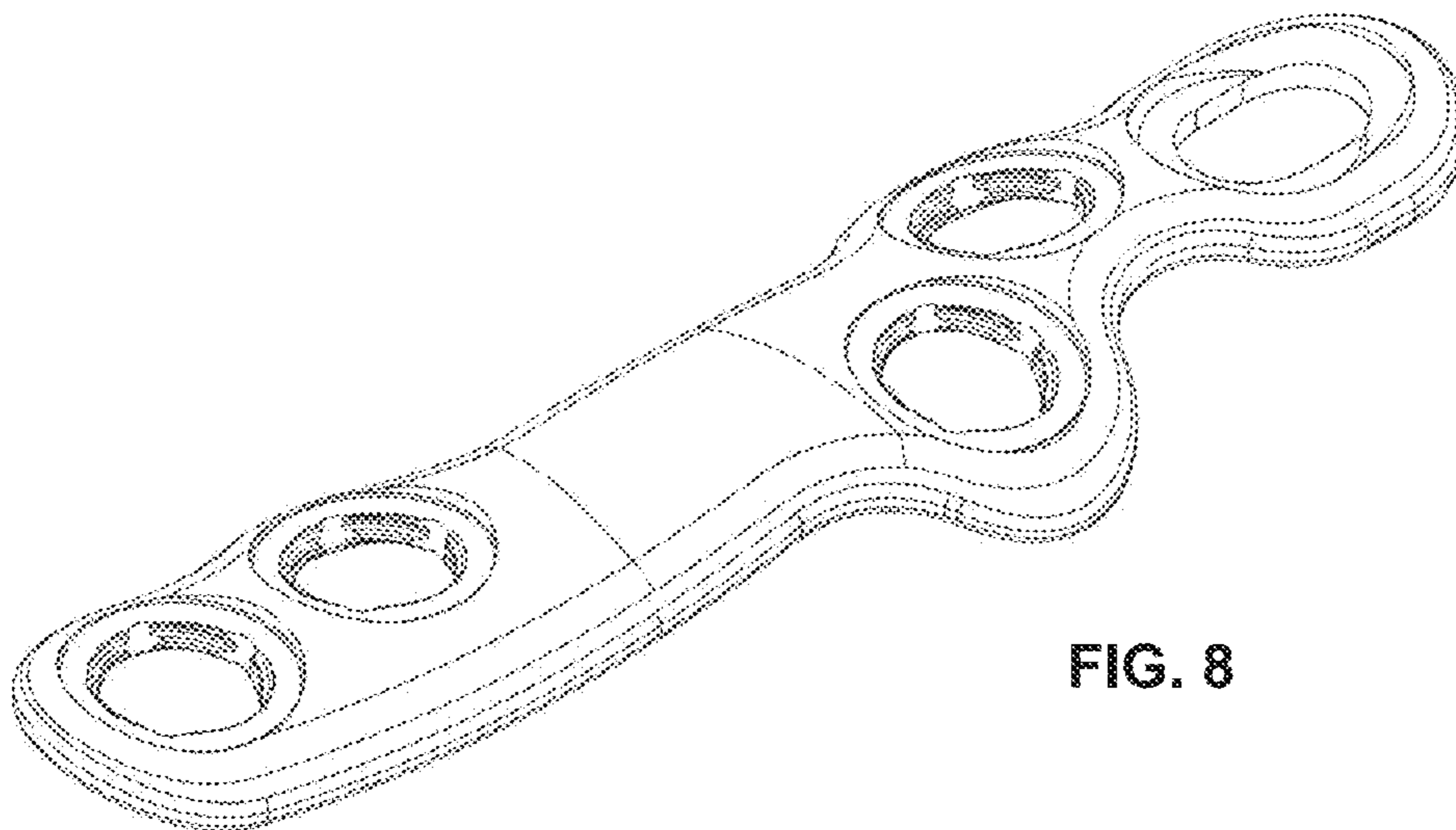

FIG. 8



FIG. 9

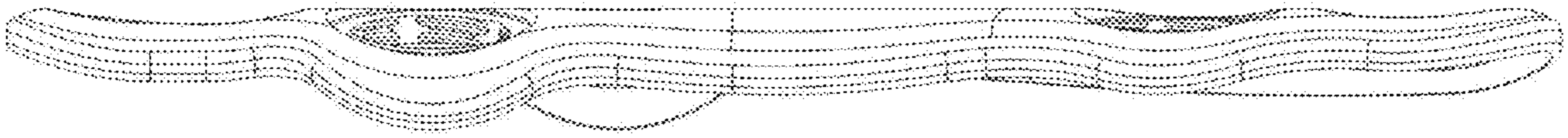

FIG. 10

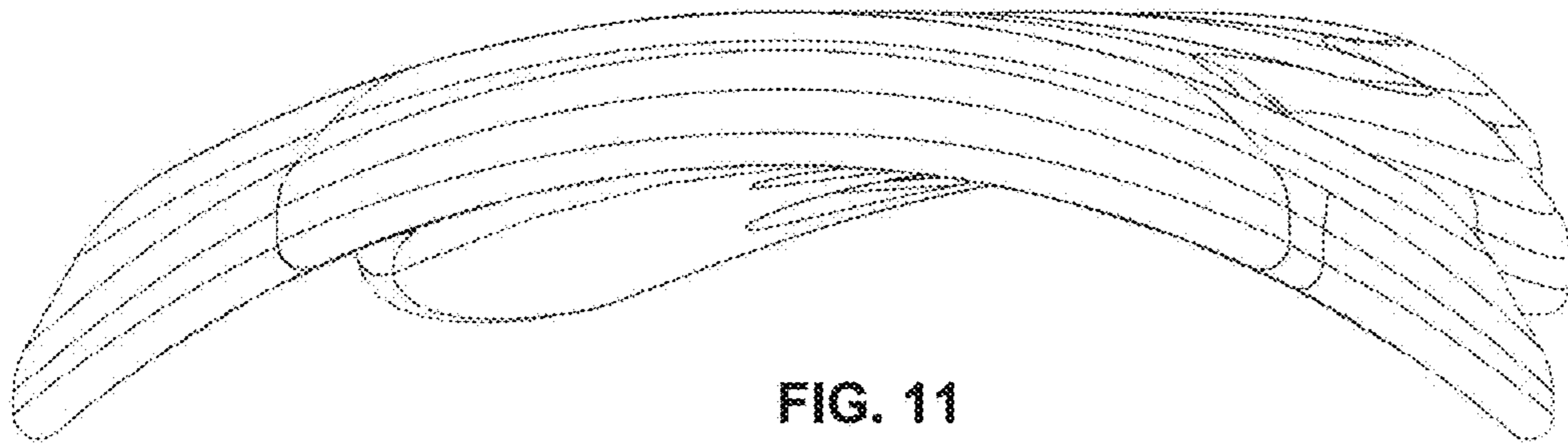

FIG. 11

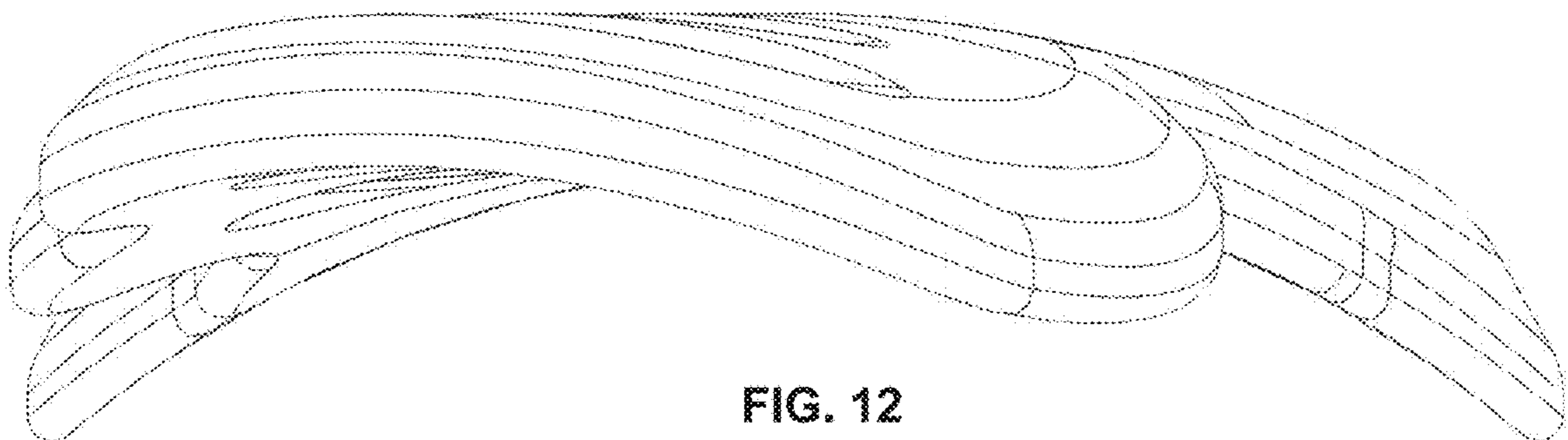

FIG. 12

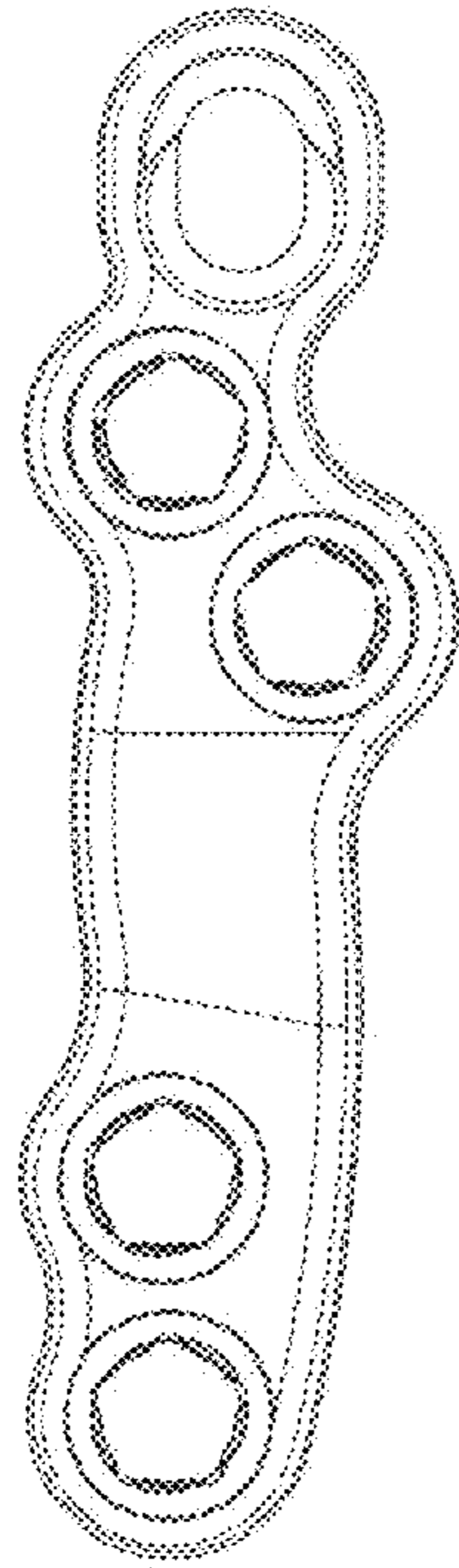

FIG. 13

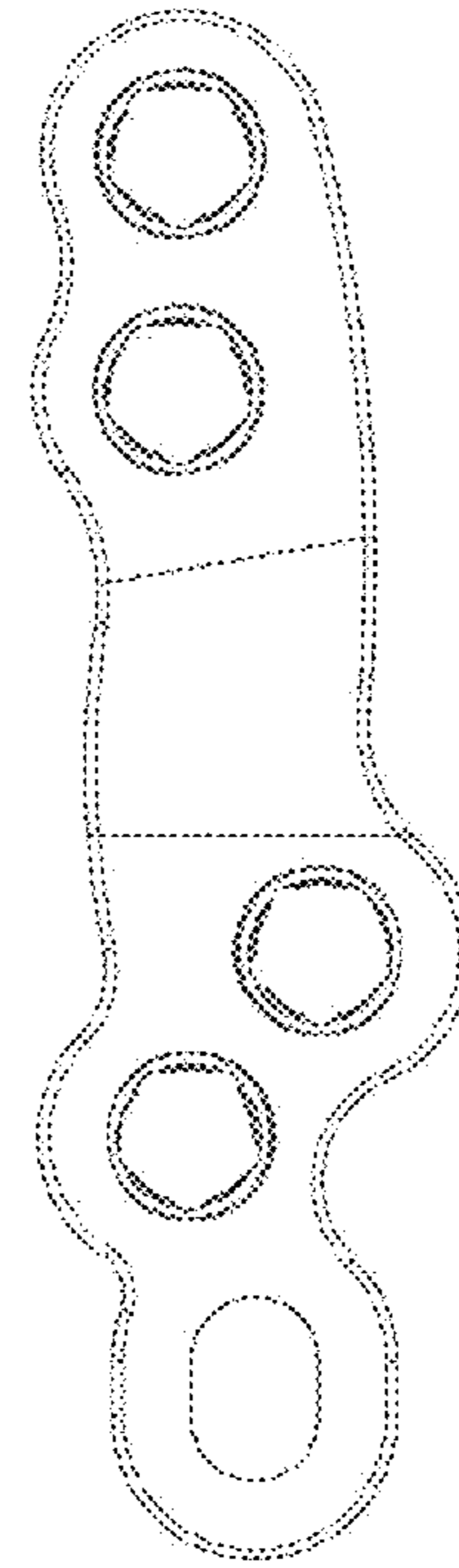

FIG. 14

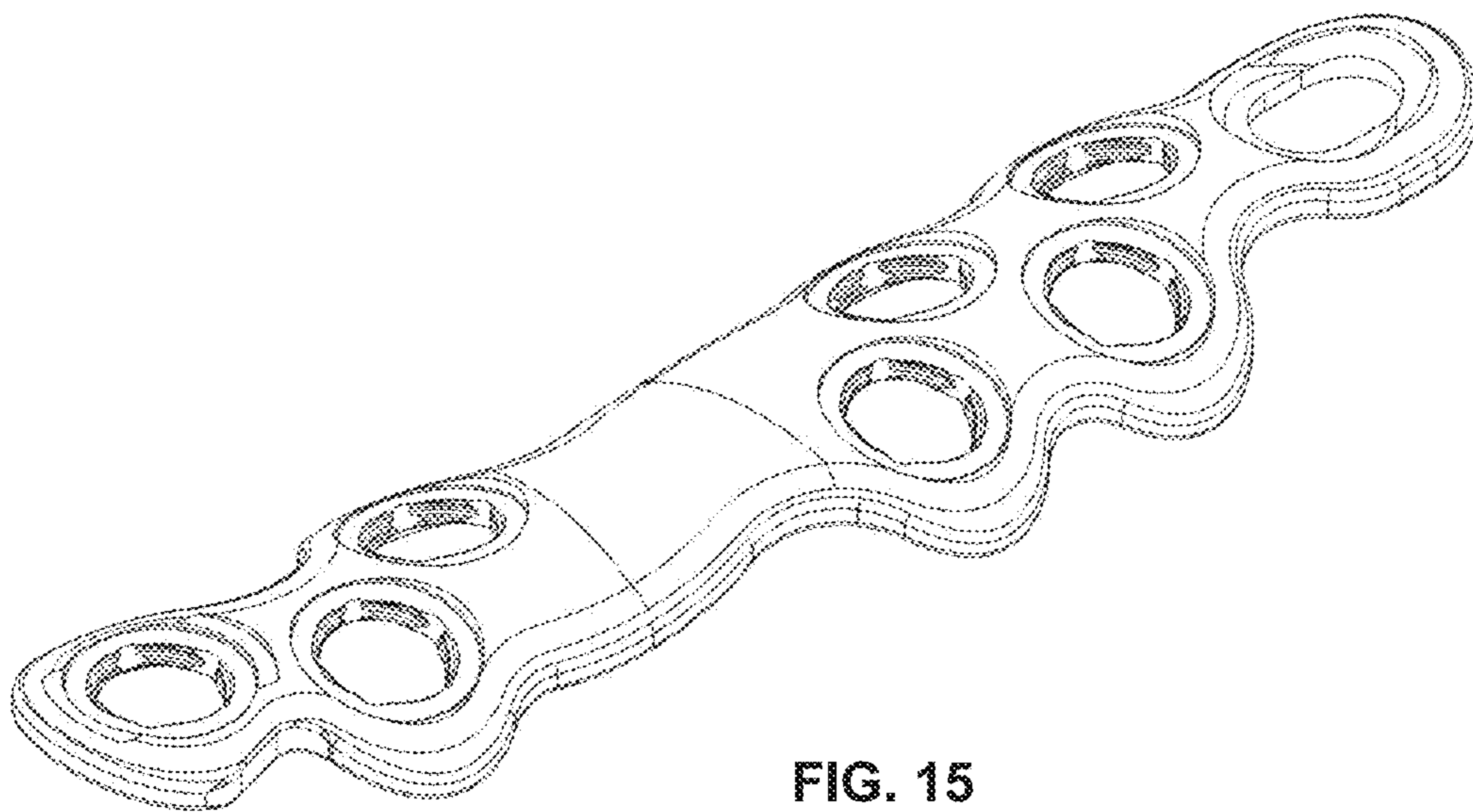

FIG. 15



FIG. 16

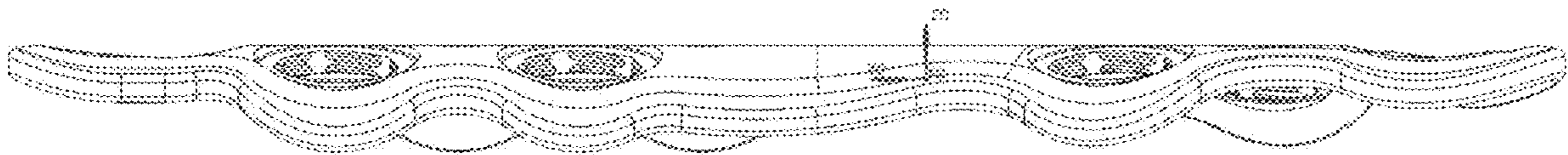

FIG. 17



FIG. 18

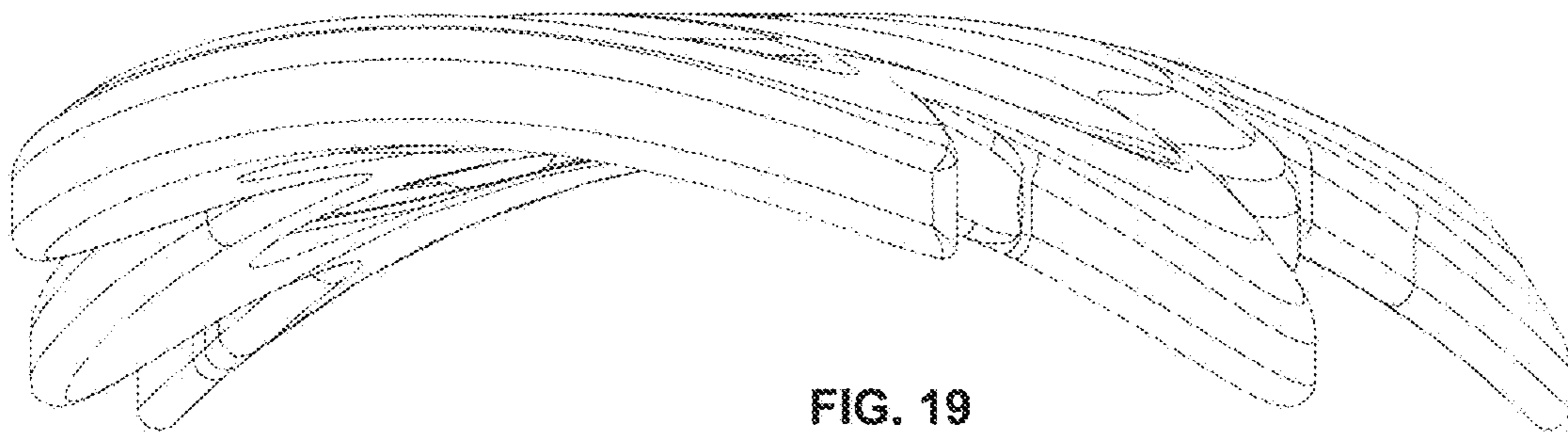

FIG. 19

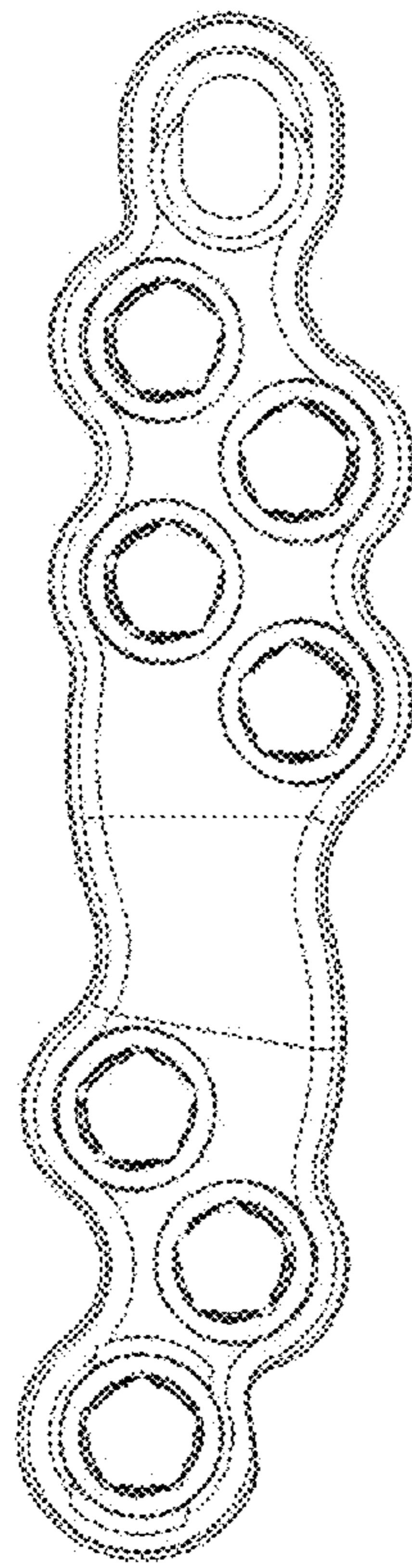

FIG. 20

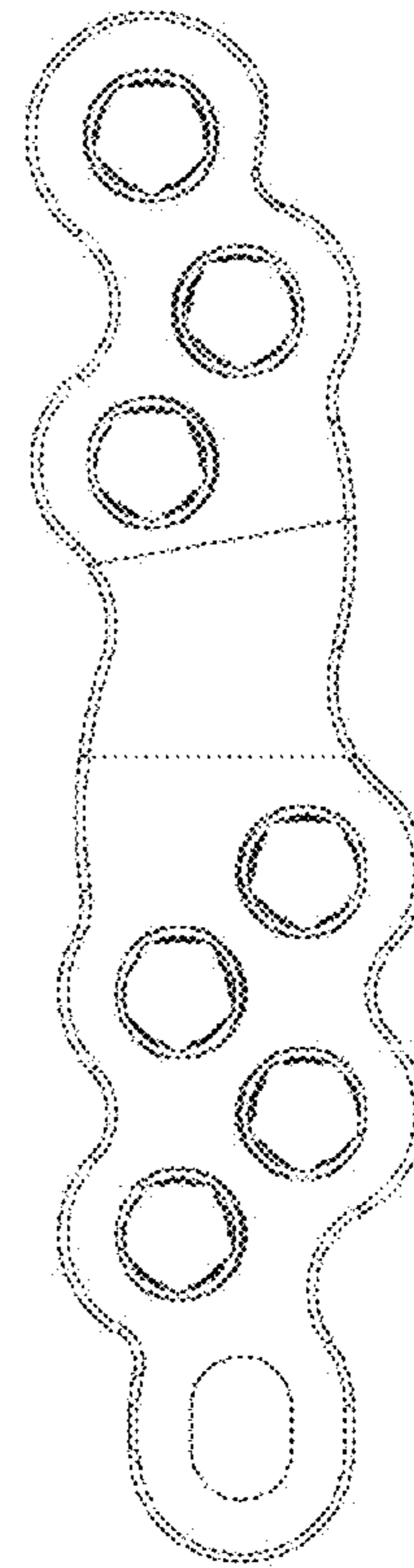

FIG. 21