



US00D971399S

(12) **United States Design Patent**  
**Liu**

(10) **Patent No.:** **US D971,399 S**  
(45) **Date of Patent:** **\*\* Nov. 29, 2022**

(54) **AIR BLOWER**

- (71) Applicant: **Lidi Liu**, Foshan (CN)
- (72) Inventor: **Lidi Liu**, Foshan (CN)
- (\*\*) Term: **15 Years**
- (21) Appl. No.: **29/807,942**
- (22) Filed: **Sep. 16, 2021**
- (51) **LOC (13) Cl.** ..... **23-04**
- (52) **U.S. Cl.**  
USPC ..... **D23/383**; D32/17
- (58) **Field of Classification Search**  
USPC .... D23/332, 341, 370, 383; D32/17-18, 22,  
D32/31-34  
CPC ..... B08B 5/02; B08B 9/093  
See application file for complete search history.

(56) **References Cited**

**U.S. PATENT DOCUMENTS**

D266,355 S	*	9/1982	Mariol	.....	D23/383
D277,516 S	*	2/1985	Hayden	.....	D32/18
D510,995 S		10/2005	Tam		
D526,102 S	*	8/2006	Adams	.....	D32/32
D565,261 S	*	3/2008	Peace	.....	D32/33
D620,208 S	*	7/2010	Mangano	.....	D32/17
D620,651 S	*	7/2010	Enervold	.....	D32/17

(Continued)

**OTHER PUBLICATIONS**

Hair-Dryer, Application No. 202130623815.6, application date Sep. 18, 2021, date published Feb. 15, 2022, published in CN, site visited Sep. 27, 2022, available at [www.orbit.com](http://www.orbit.com).\*

(Continued)

*Primary Examiner* — Sharon S Oum

(57) **CLAIM**

The ornamental design for an air blower, as shown and described.

**DESCRIPTION**

FIG. 1 is a perspective view of a first head component of an air blower showing my new design, shown separately for ease of illustration;

FIG. 2 is another perspective view thereof;

FIG. 3 is a front elevational view thereof;

FIG. 4 is a rear elevational view thereof;

FIG. 5 is a left side elevational view thereof;

FIG. 6 is a right side elevational view thereof;

FIG. 7 is a top plan view thereof;

FIG. 8 is a bottom plan view thereof;

FIG. 9 is a perspective view of a second head component of the air blower shown separately for ease of illustration;

FIG. 10 is another perspective view thereof;

FIG. 11 is a front elevational view thereof;

FIG. 12 is a rear elevational view thereof;

FIG. 13 is a left side elevational view thereof;

FIG. 14 is a right side elevational view thereof;

FIG. 15 is a top plan view thereof;

FIG. 16 is a bottom plan view thereof;

FIG. 17 is a perspective view of a main body of the air blower shown separately for ease of illustration;

FIG. 18 is another perspective view thereof;

FIG. 19 is a front elevational view thereof;

FIG. 20 is a rear elevational view thereof;

FIG. 21 is a left side elevational view thereof;

FIG. 22 is a right side elevational view thereof;

FIG. 23 is a top plan view thereof;

FIG. 24 is a bottom plan view thereof;

FIG. 25 is a perspective view of the second head component and the main body where the second head component is assembled with the main body;

FIG. 26 is a perspective view of the first head component and the main body where the first head component is assembled with the main body; and,

FIG. 27 is an exploded perspective view thereof.

The broken lines in the drawings depict portions of the air blower that form no part of the claimed design.

**1 Claim, 27 Drawing Sheets**

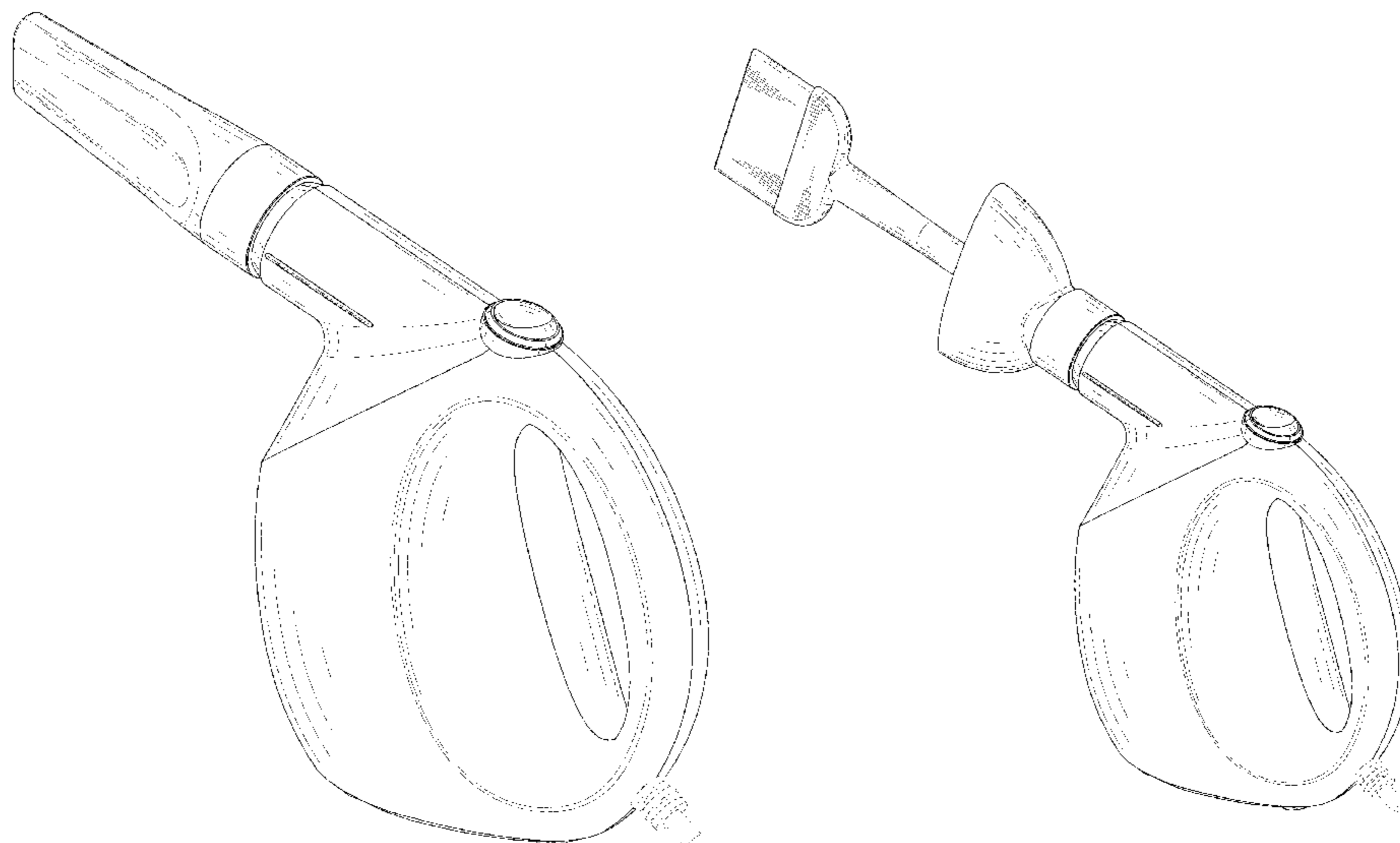

(56)

**References Cited**

U.S. PATENT DOCUMENTS

D656,693 S \* 3/2012 Lavy ..... D32/17  
D674,564 S \* 1/2013 Mangano ..... D32/17  
D716,007 S \* 10/2014 Mangano ..... D32/17  
D723,228 S \* 2/2015 Luglan ..... D32/18  
D764,125 S \* 8/2016 Palladino ..... D32/33  
D771,331 S \* 11/2016 Chaklos ..... D32/17  
D826,491 S 8/2018 Yang et al.  
D892,419 S \* 8/2020 He ..... D32/17  
D939,164 S \* 12/2021 Lee ..... D32/32  
D963,975 S \* 9/2022 He ..... D32/18  
D964,673 S \* 9/2022 Ma ..... D32/17  
2008/0163894 A1 \* 7/2008 Henderson ..... B08B 3/04  
134/6  
2021/0331216 A1 \* 10/2021 He ..... A47L 9/30

OTHER PUBLICATIONS

UCONS Compressed Air Duster 3.0, date first reviewed Aug. 6, 2022, site visited Sep. 27, 2022, available at <[https://www.amazon.com/UCONS-Compressed-Air-Duster-3-0/dp/B0B5L2RR9D/ref=cm\\_cr\\_ar\\_p\\_d\\_product\\_top?ie=UTF8](https://www.amazon.com/UCONS-Compressed-Air-Duster-3-0/dp/B0B5L2RR9D/ref=cm_cr_ar_p_d_product_top?ie=UTF8)>.\*

\* cited by examiner

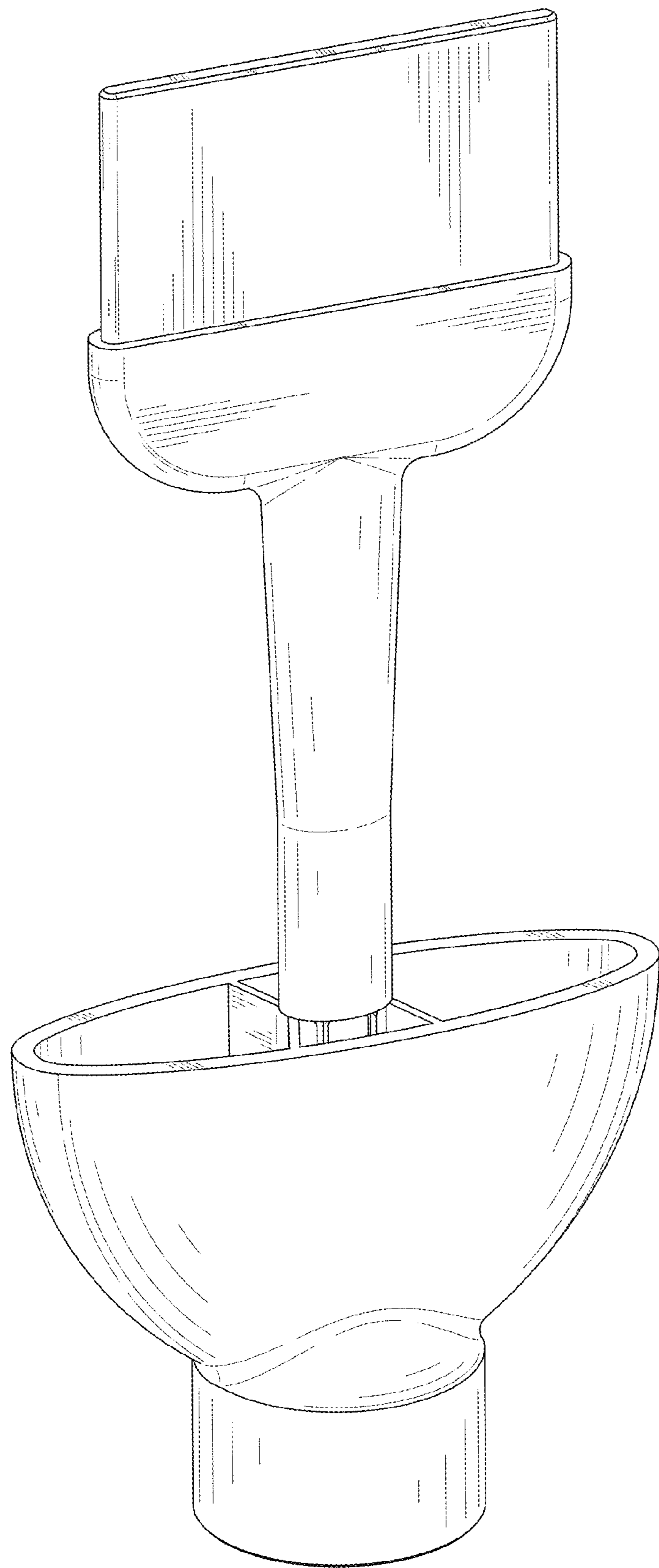

FIG. 1

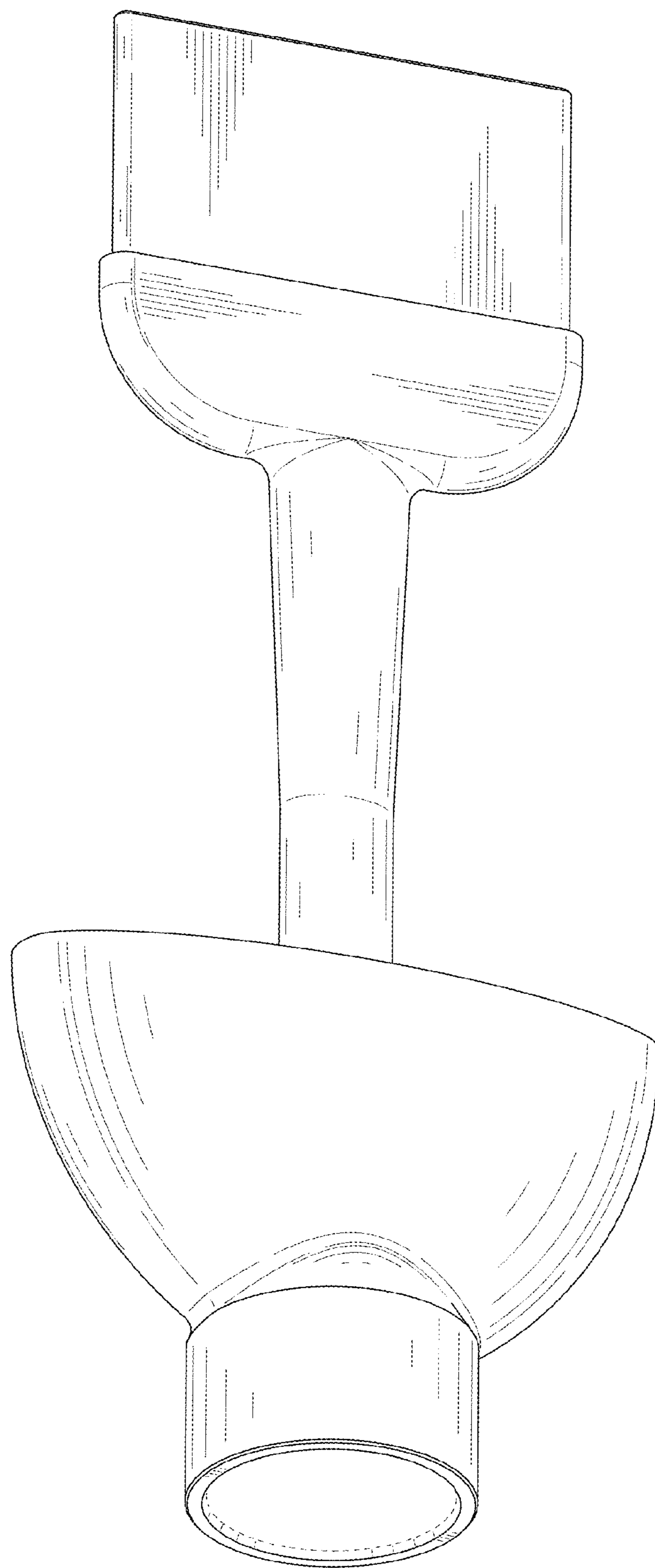

FIG. 2

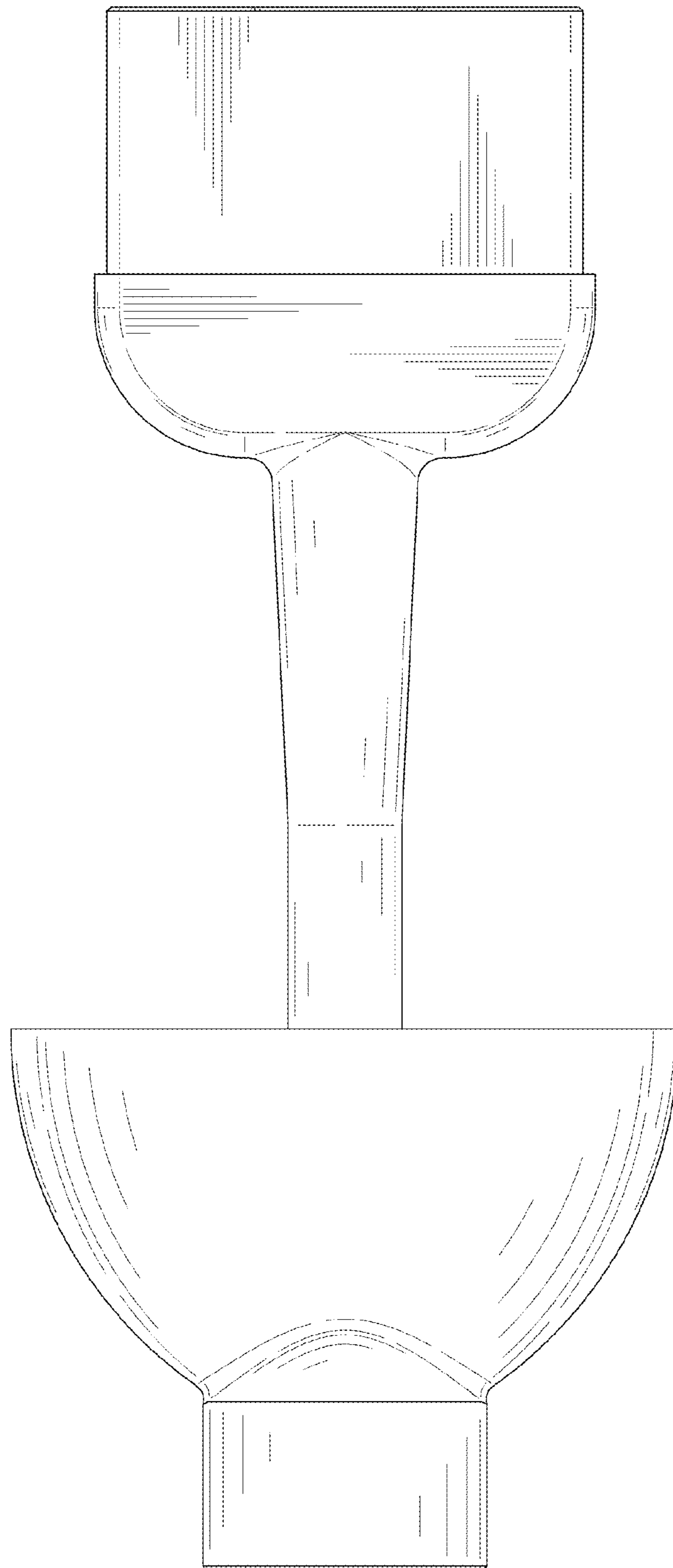

FIG. 3

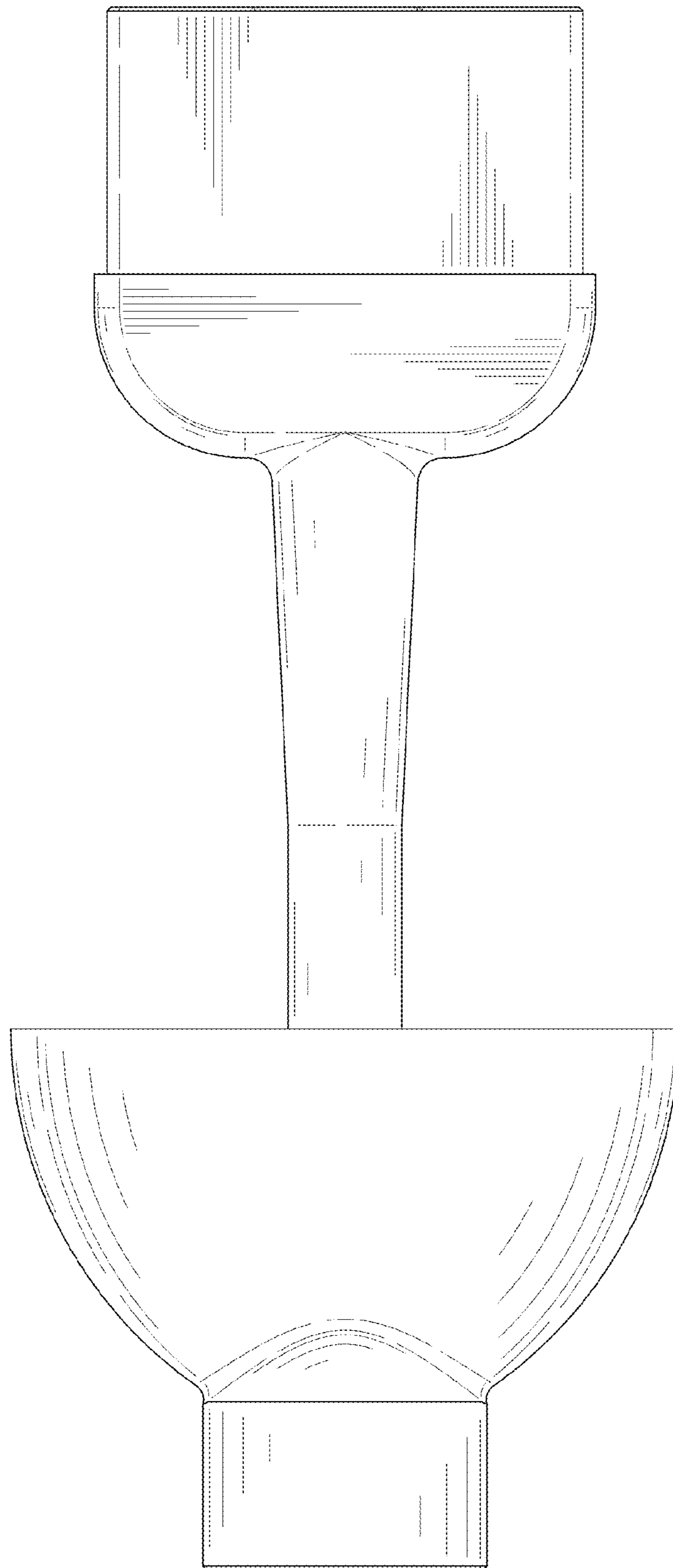

FIG. 4

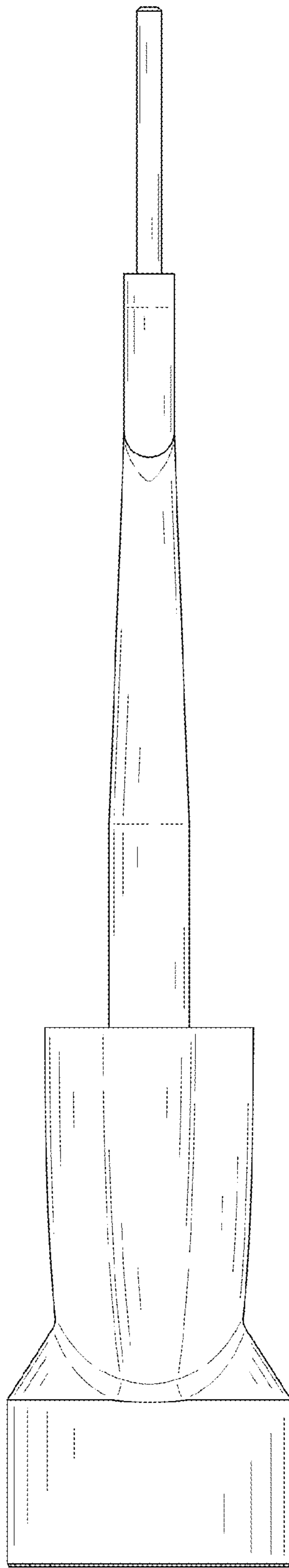

FIG. 5

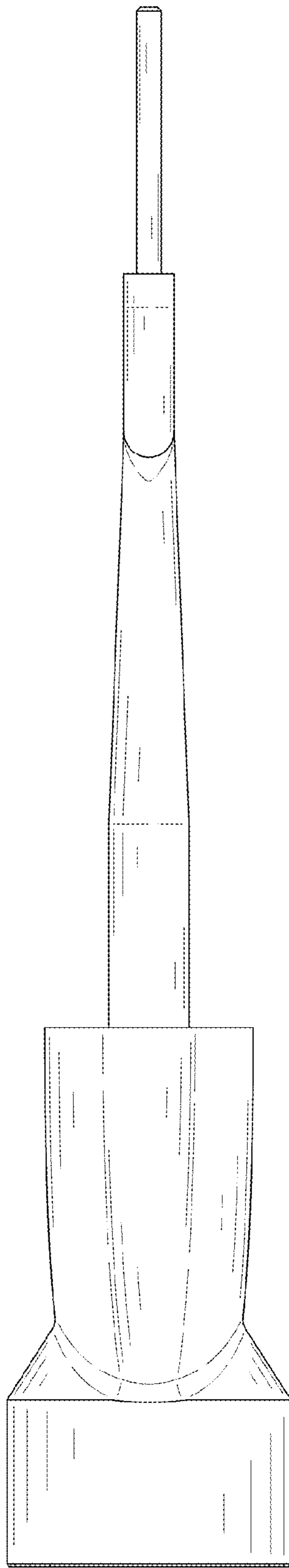

FIG. 6



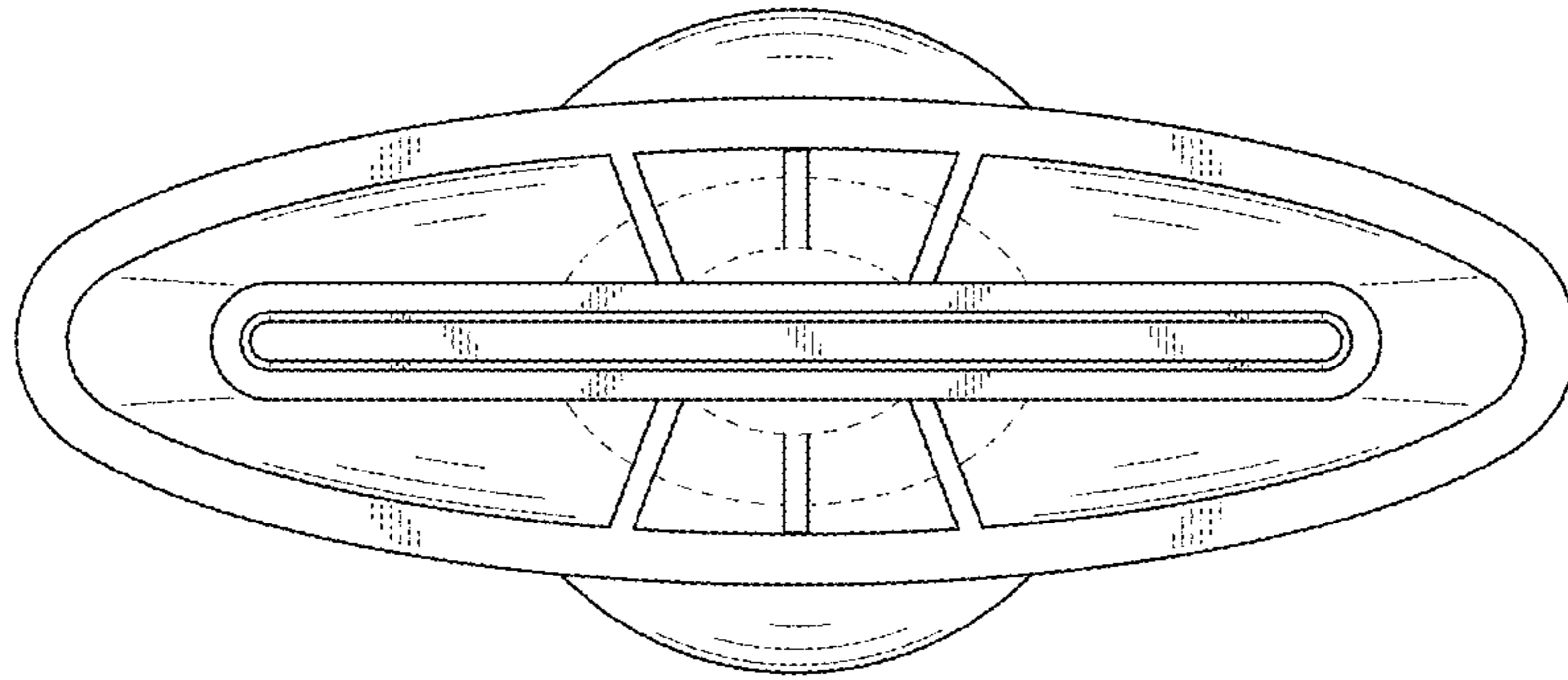

FIG. 7

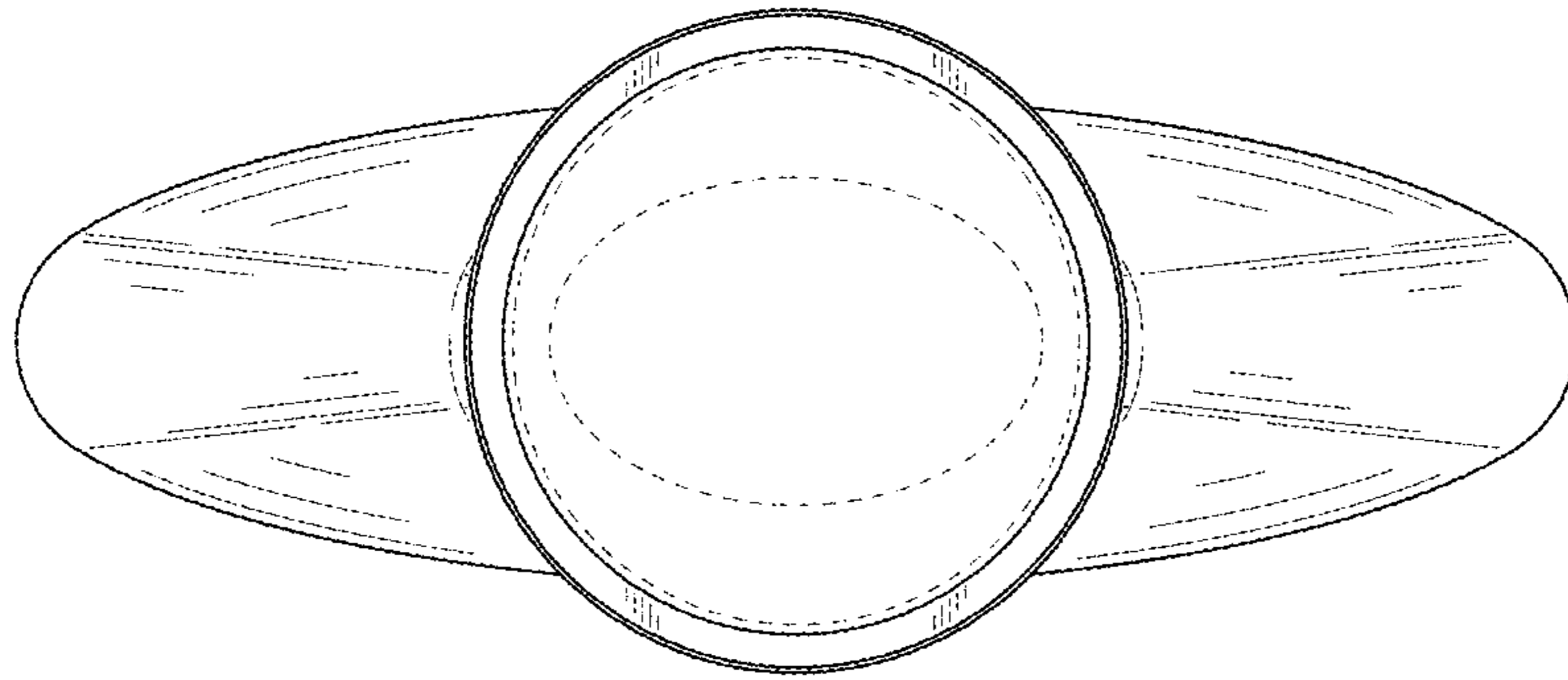

FIG. 8

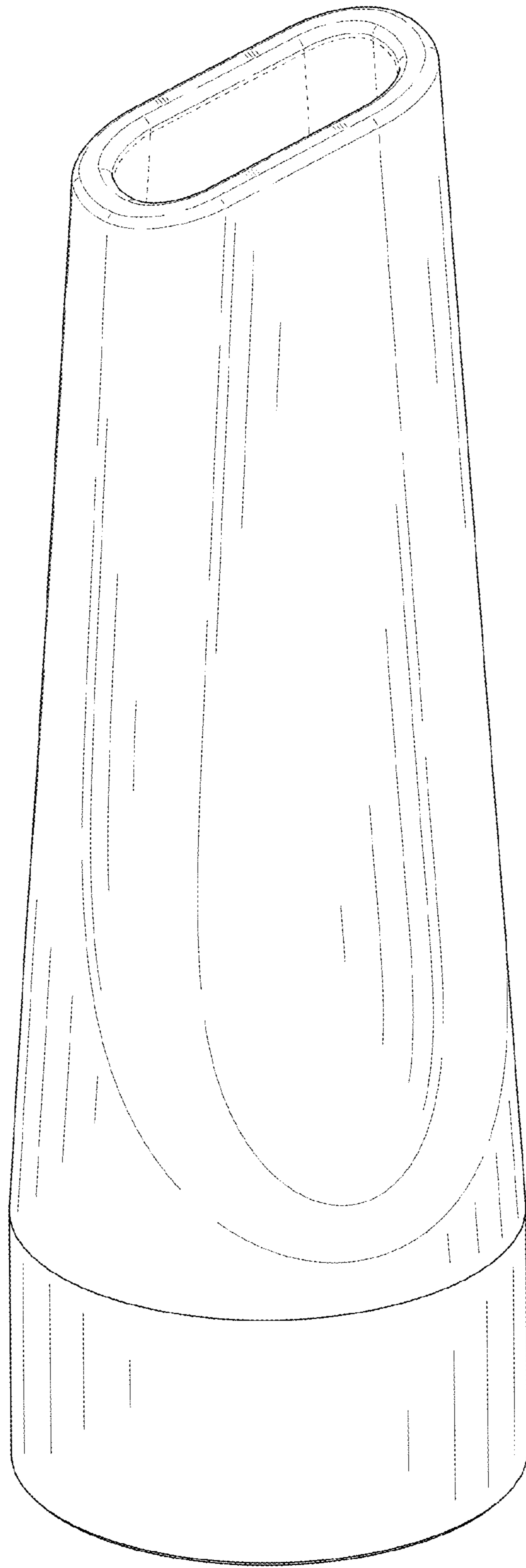

FIG. 9

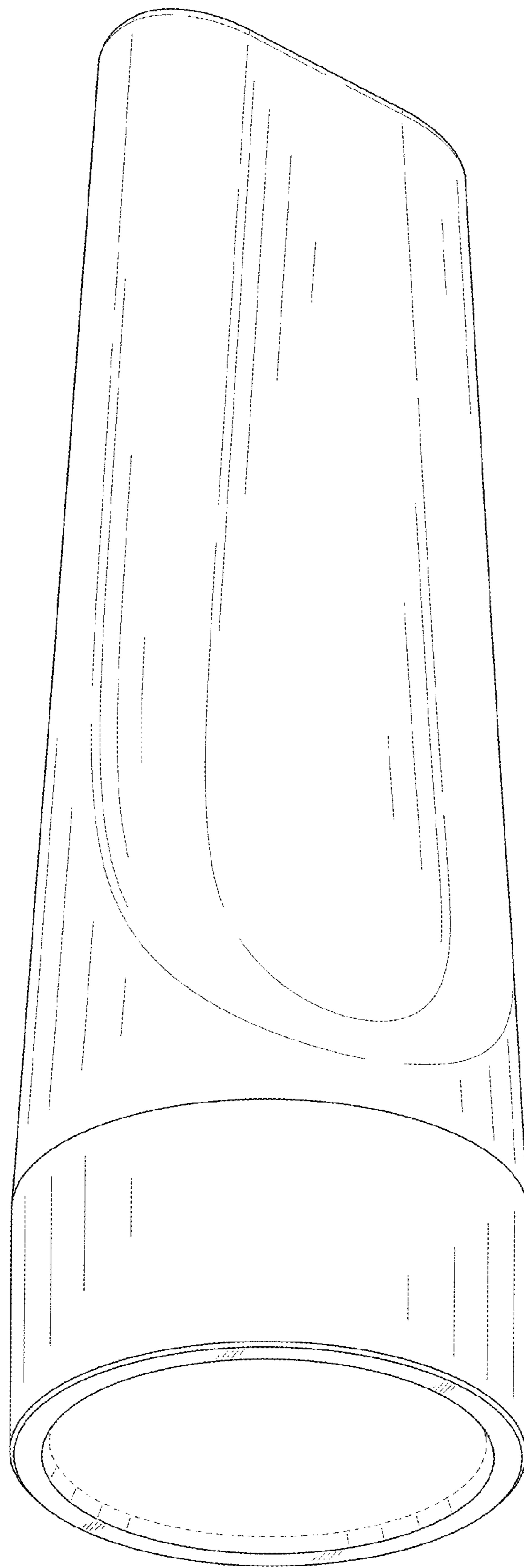

FIG. 10

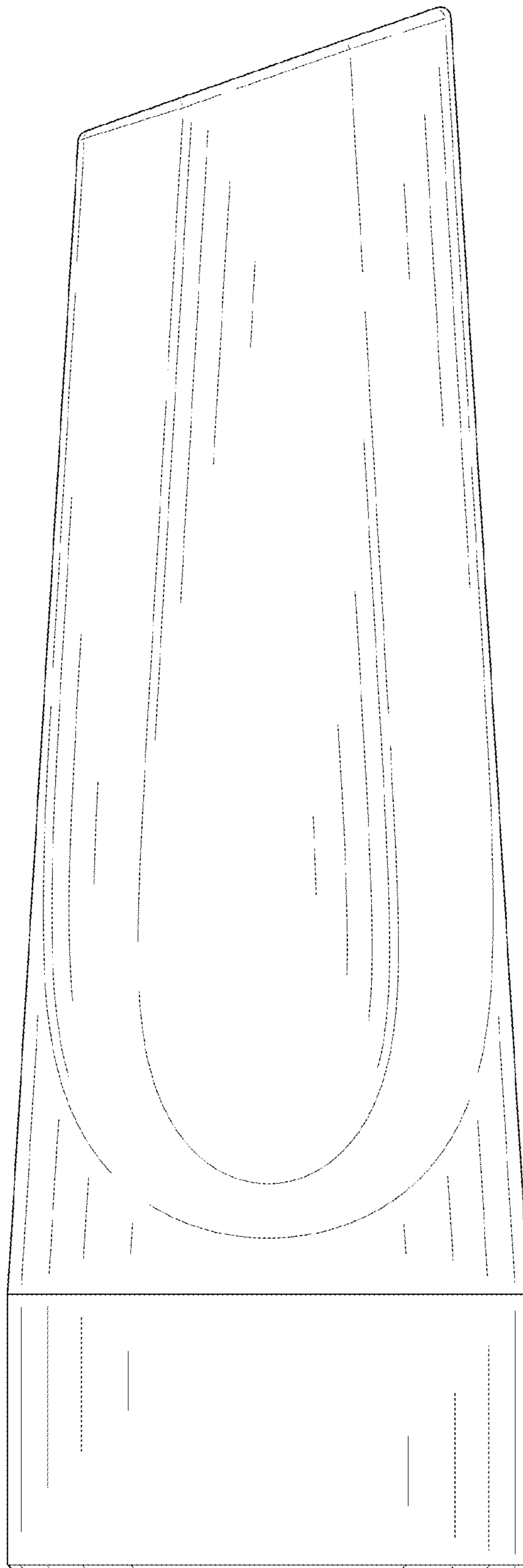

FIG. 11

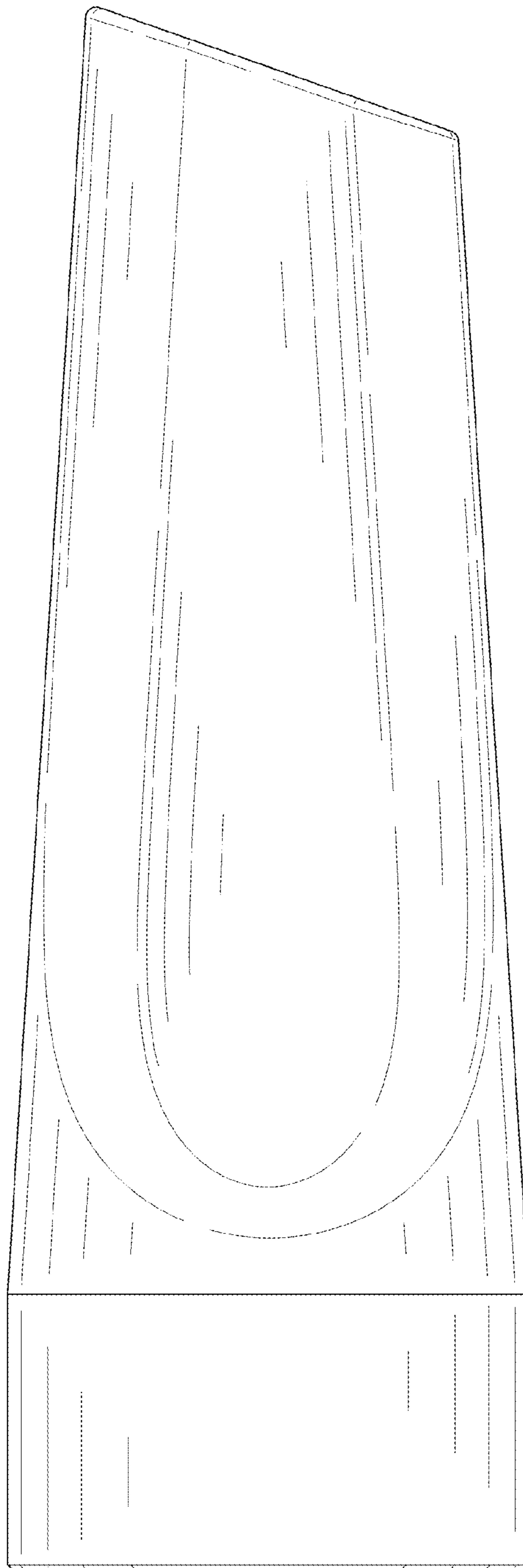

FIG. 12

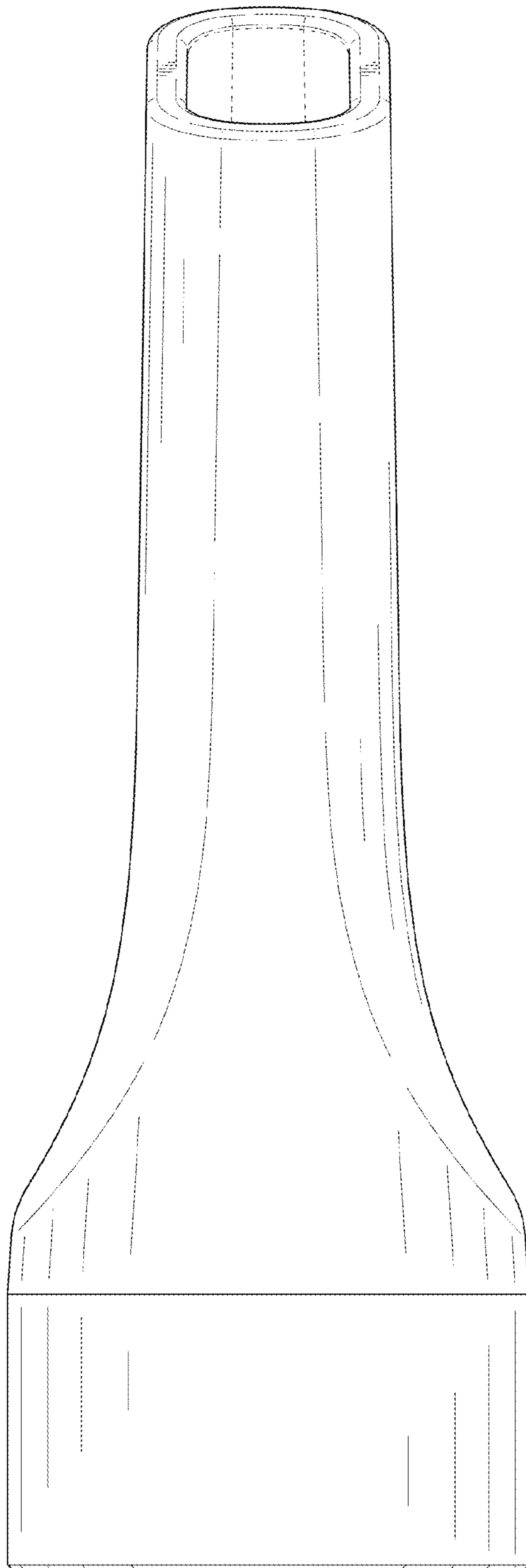

FIG. 13

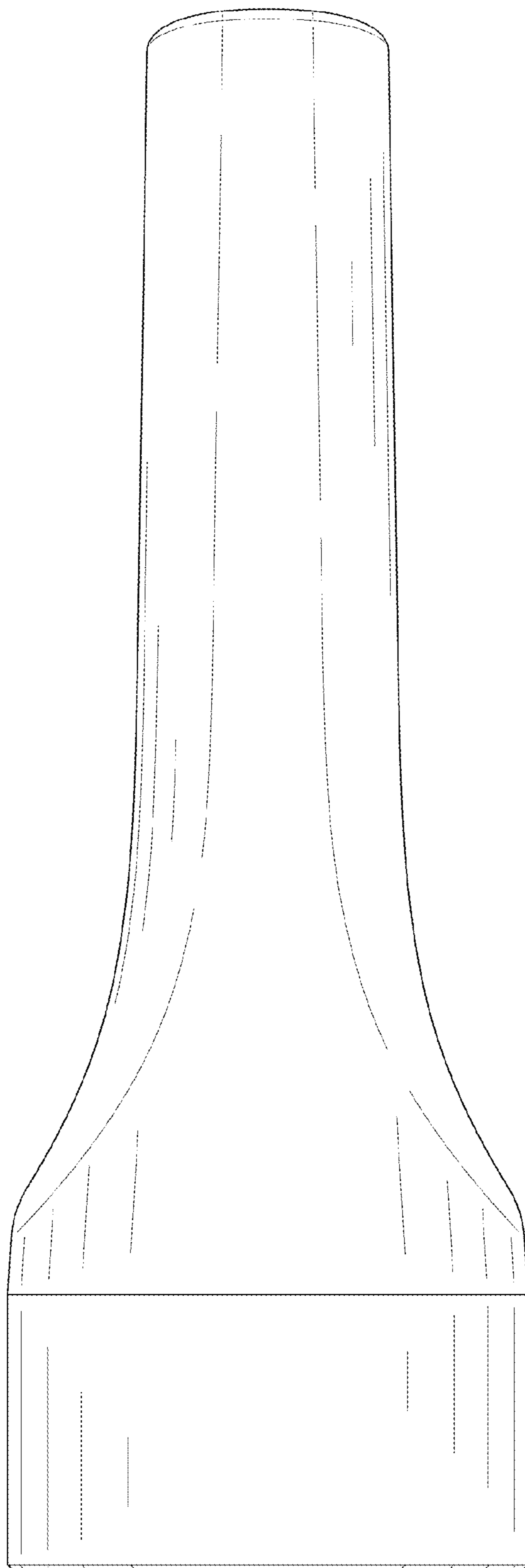

FIG. 14



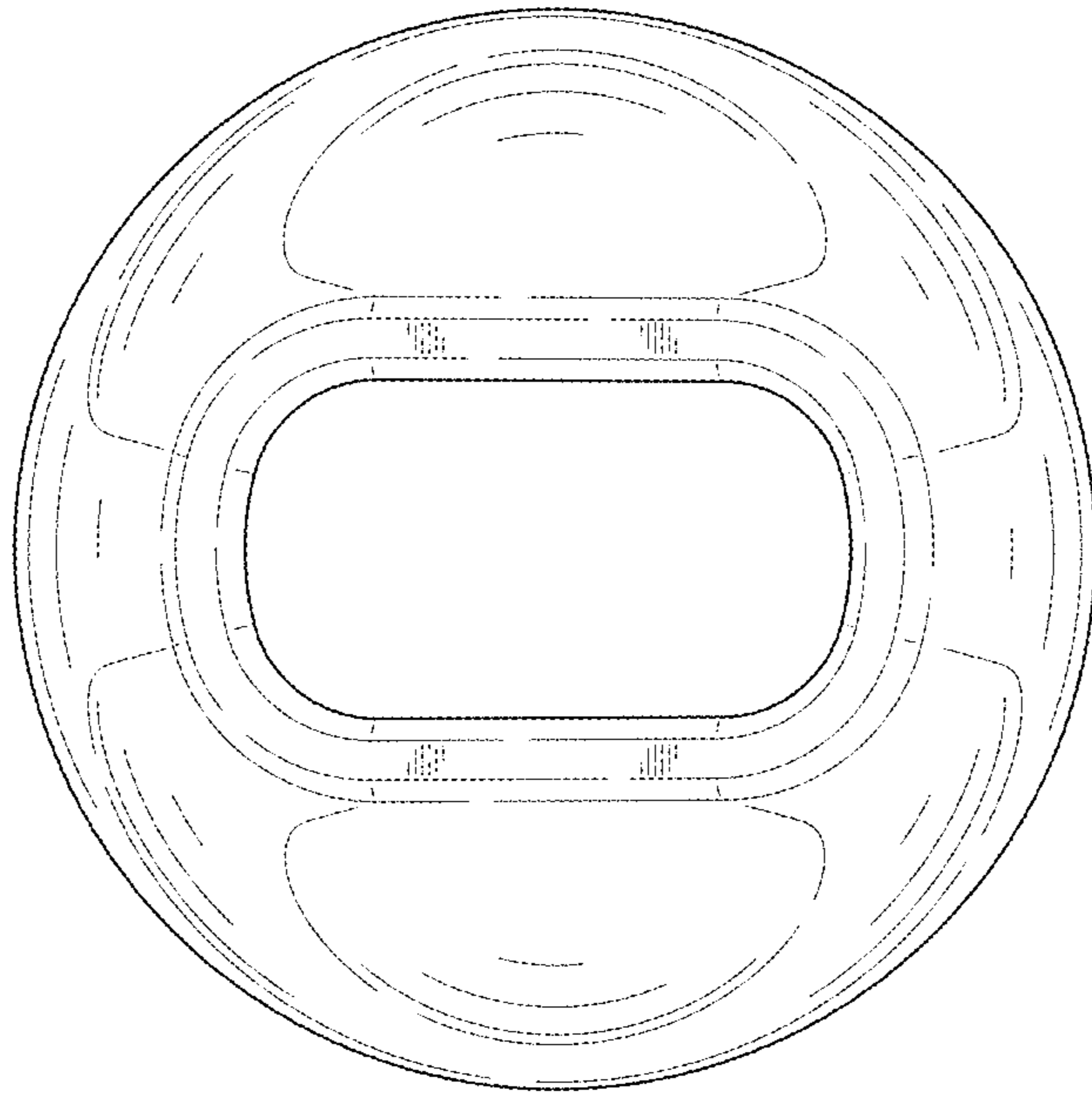

FIG. 15

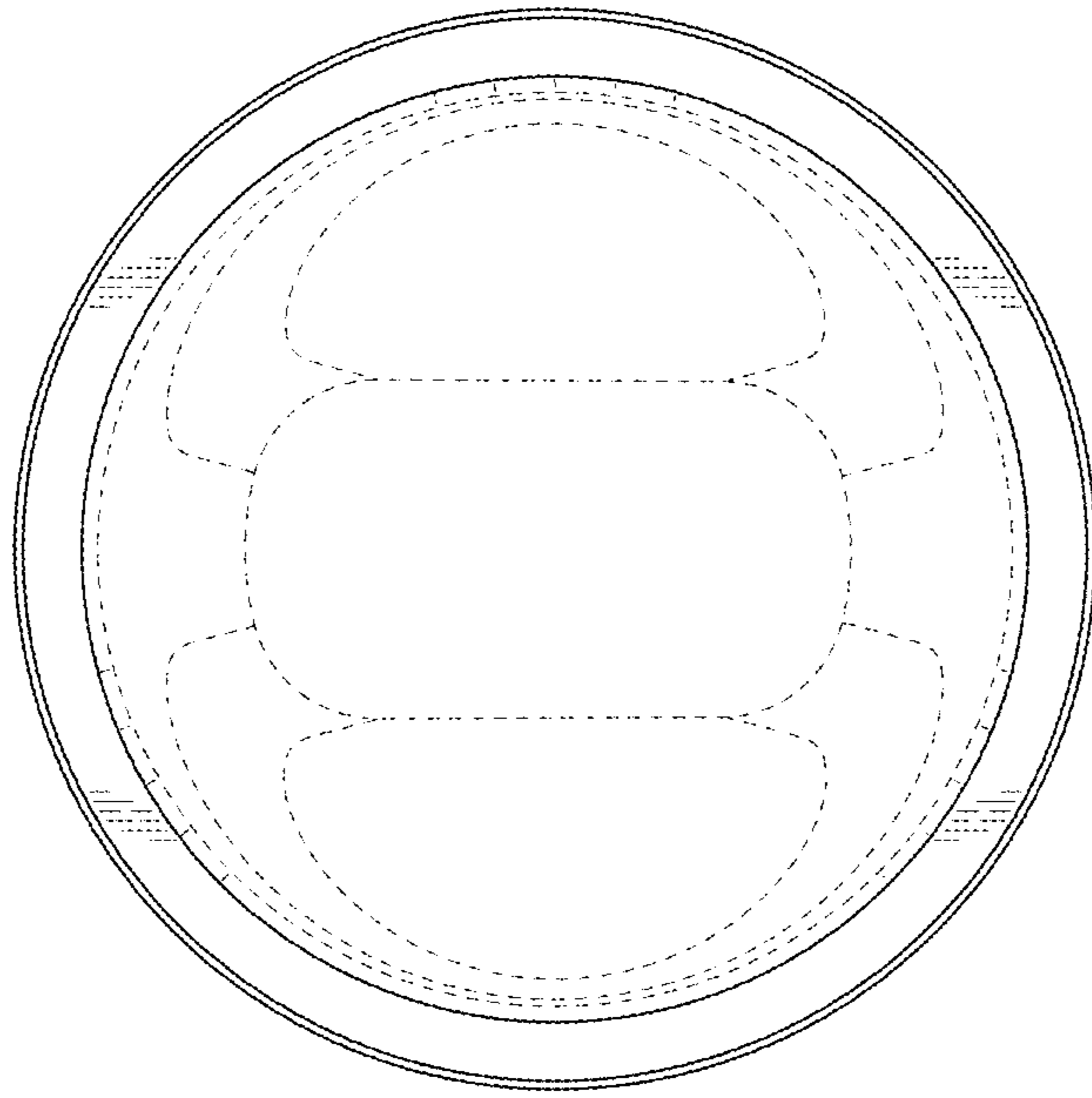

FIG. 16

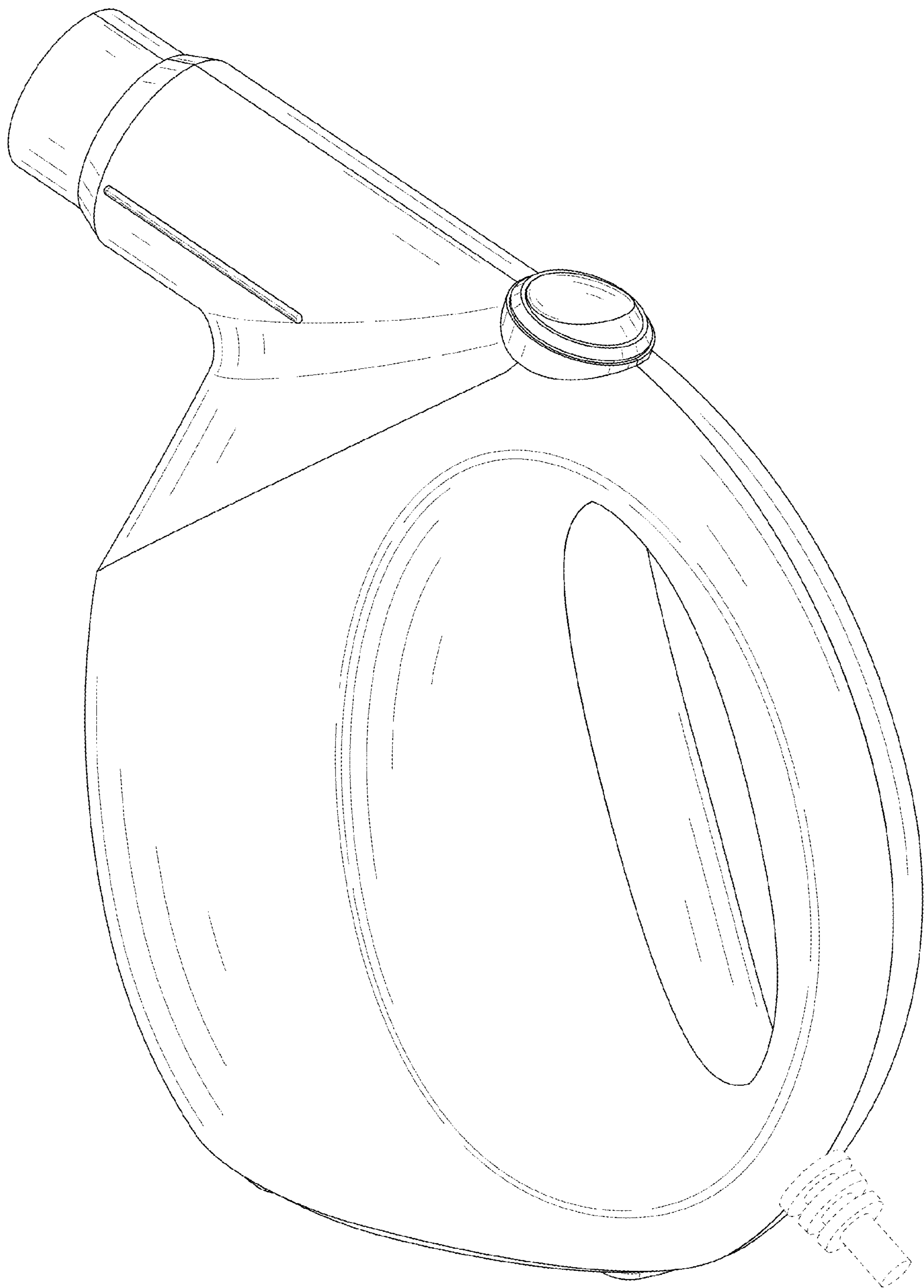

FIG. 17

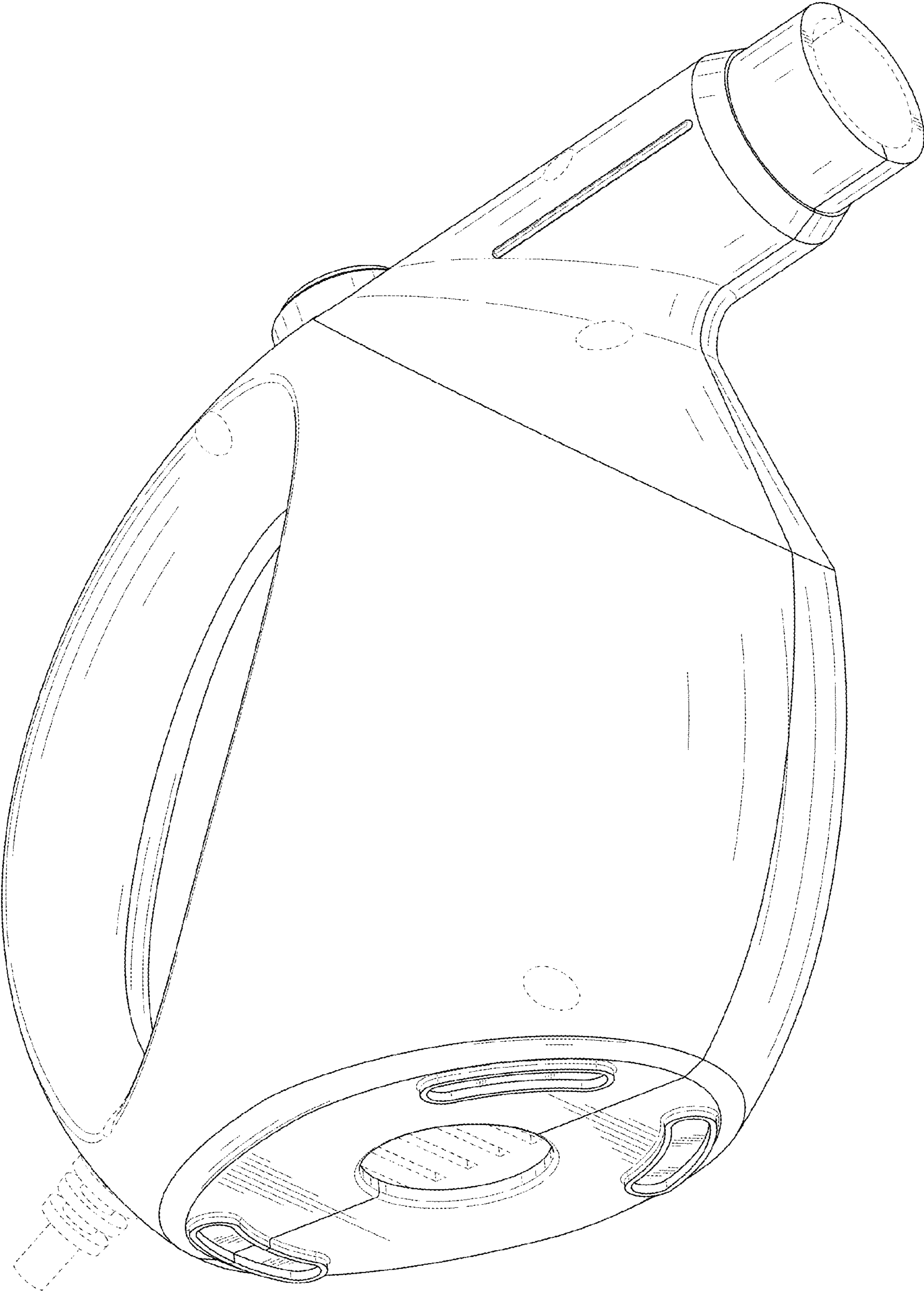

FIG. 18

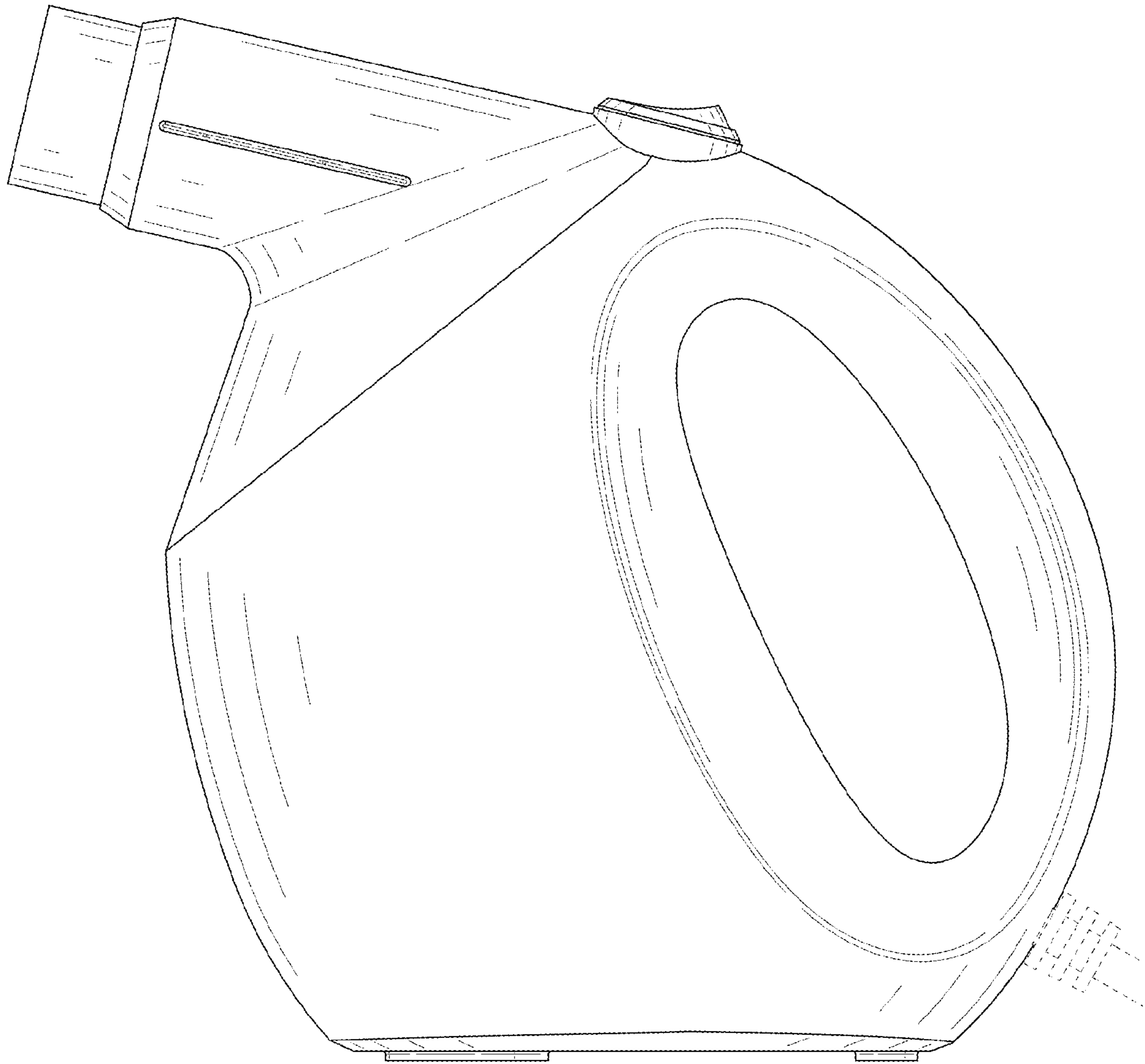

FIG. 19

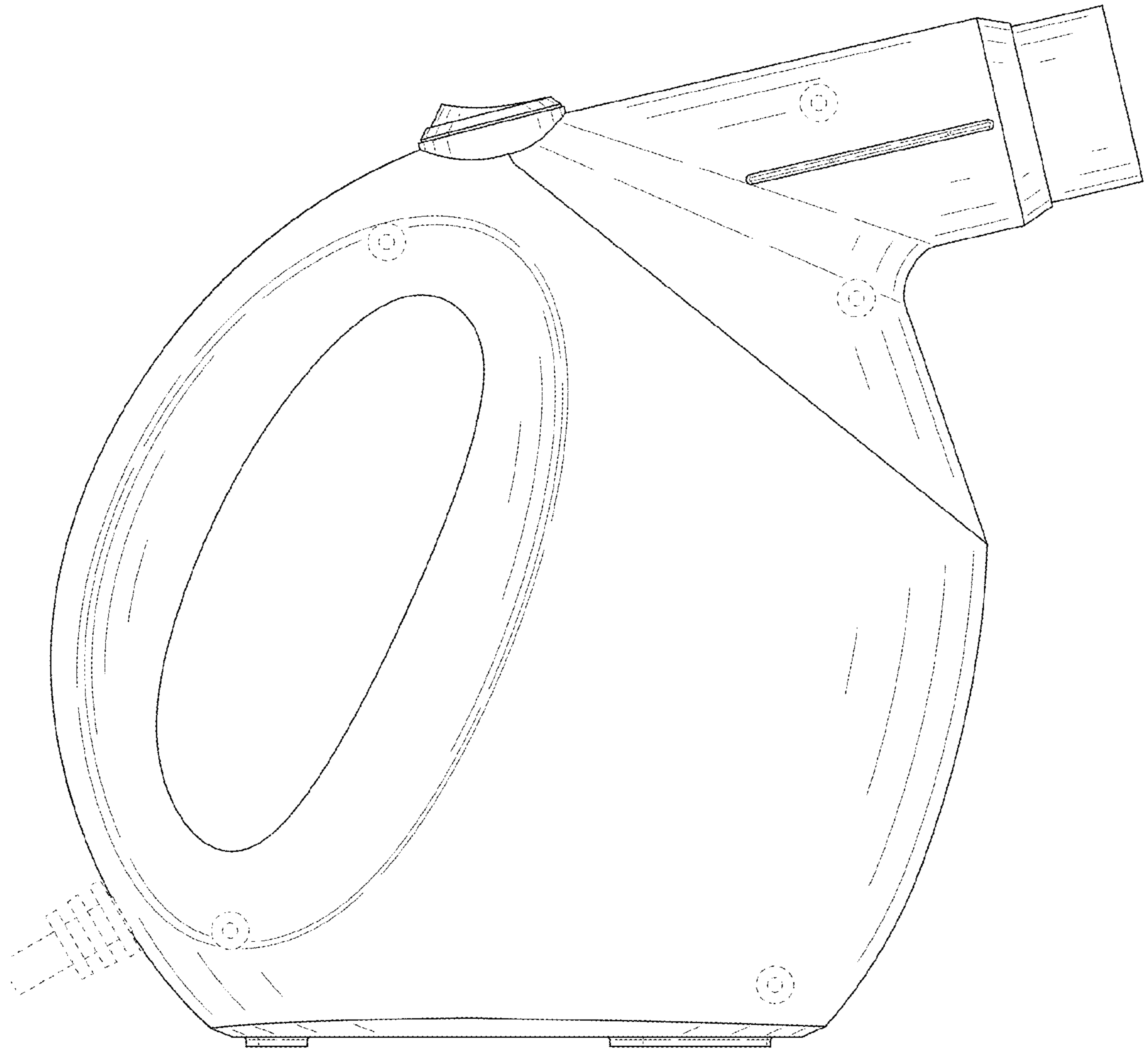

FIG. 20

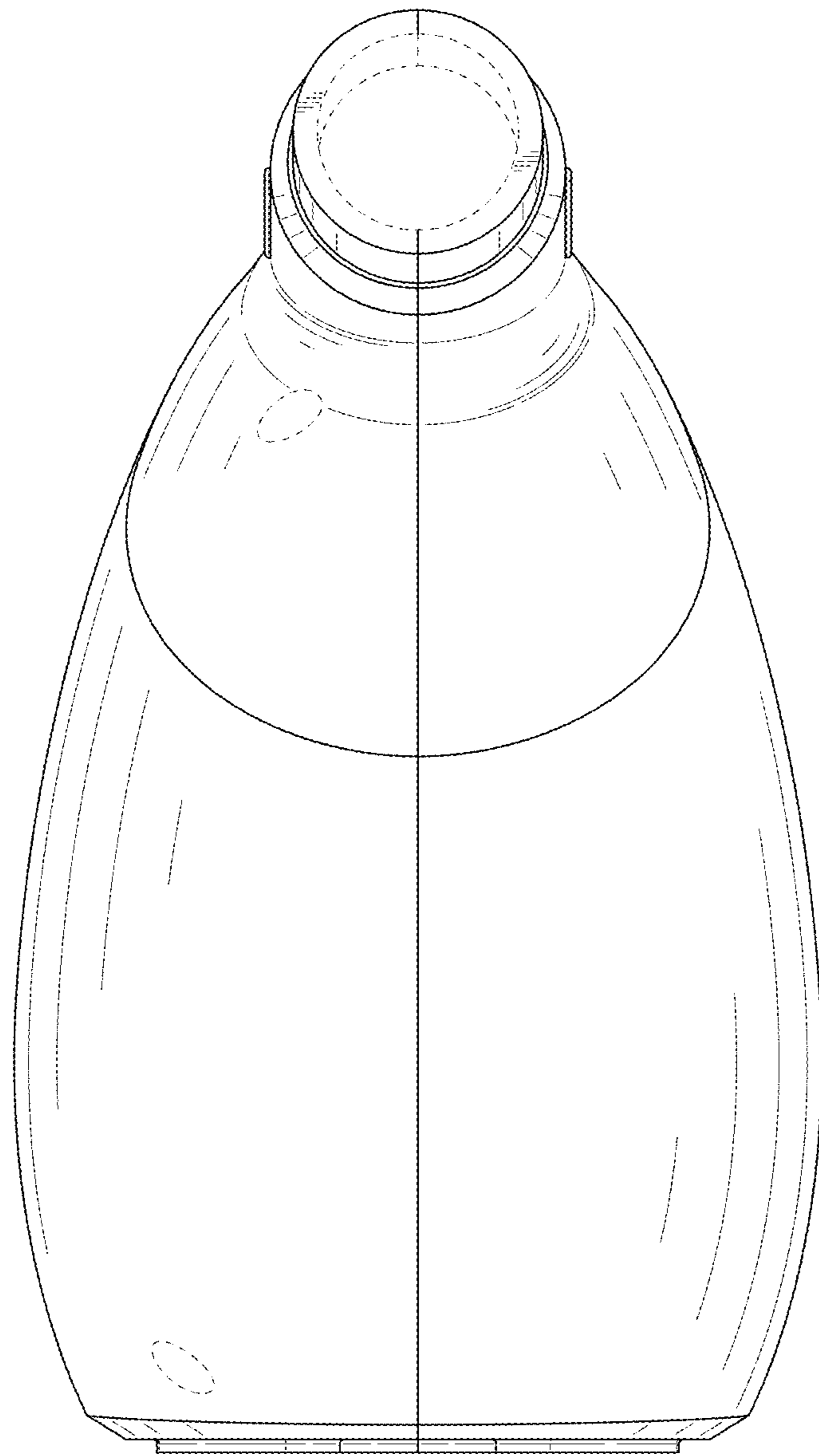

FIG. 21

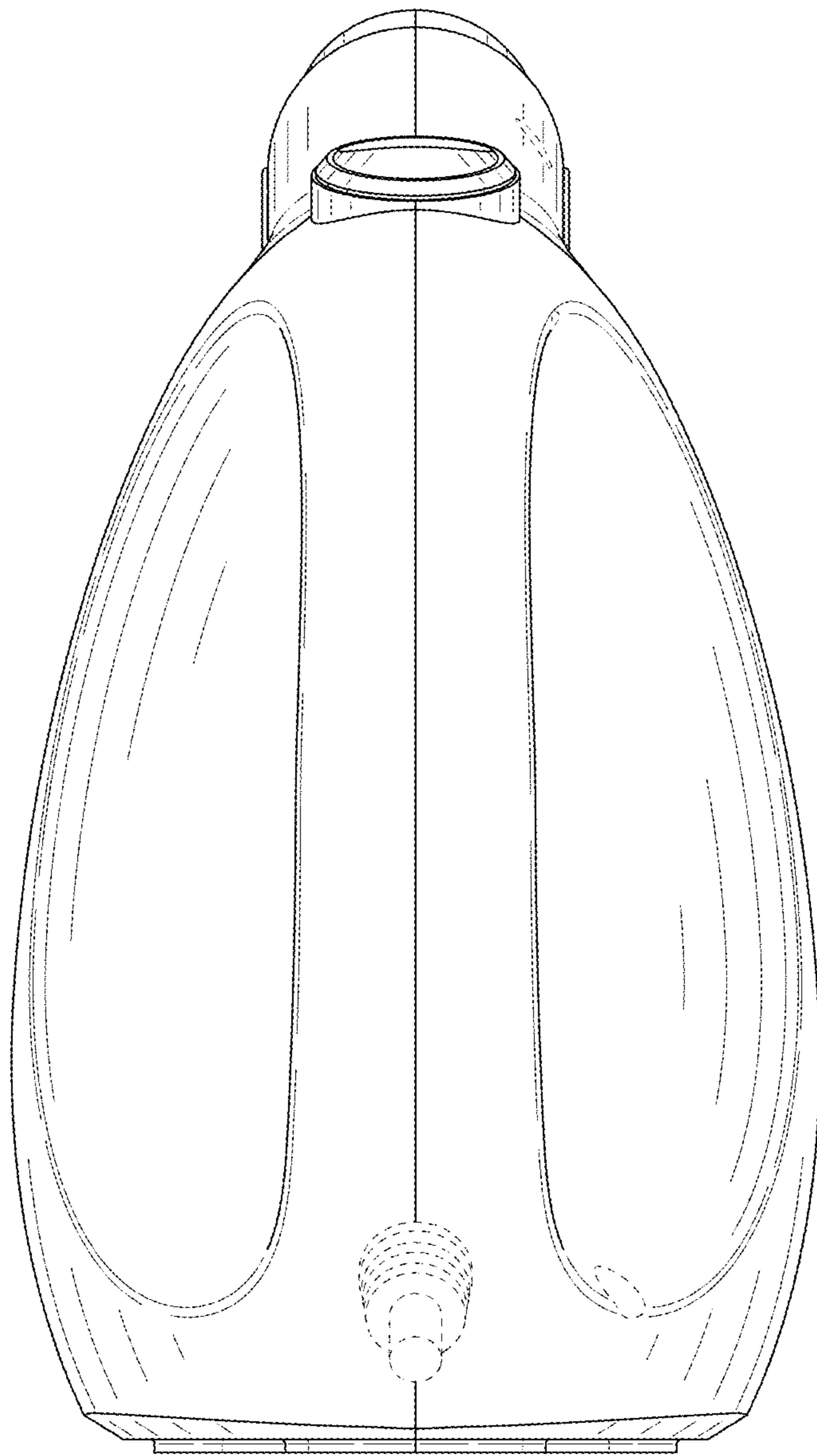

FIG. 22



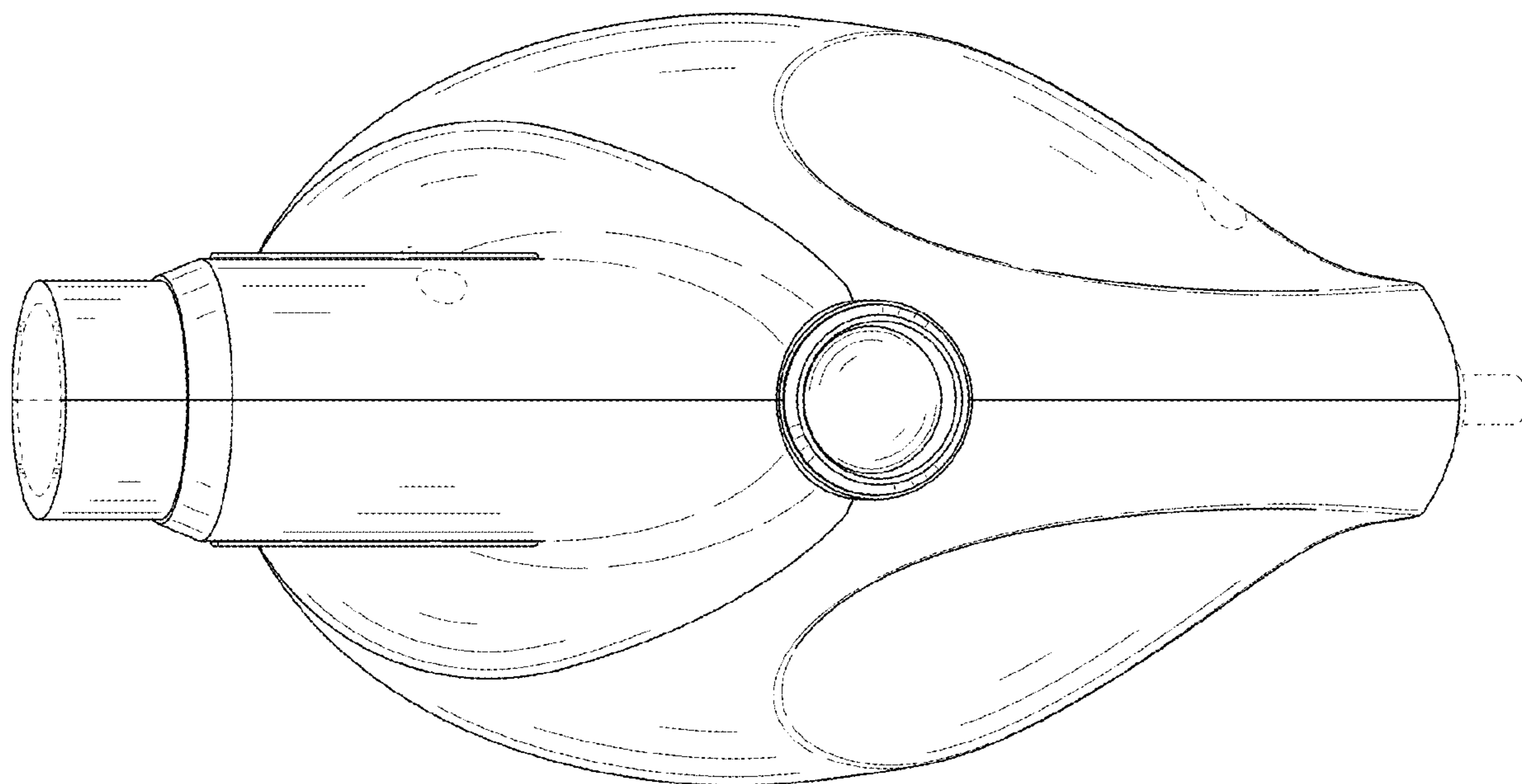

FIG. 23

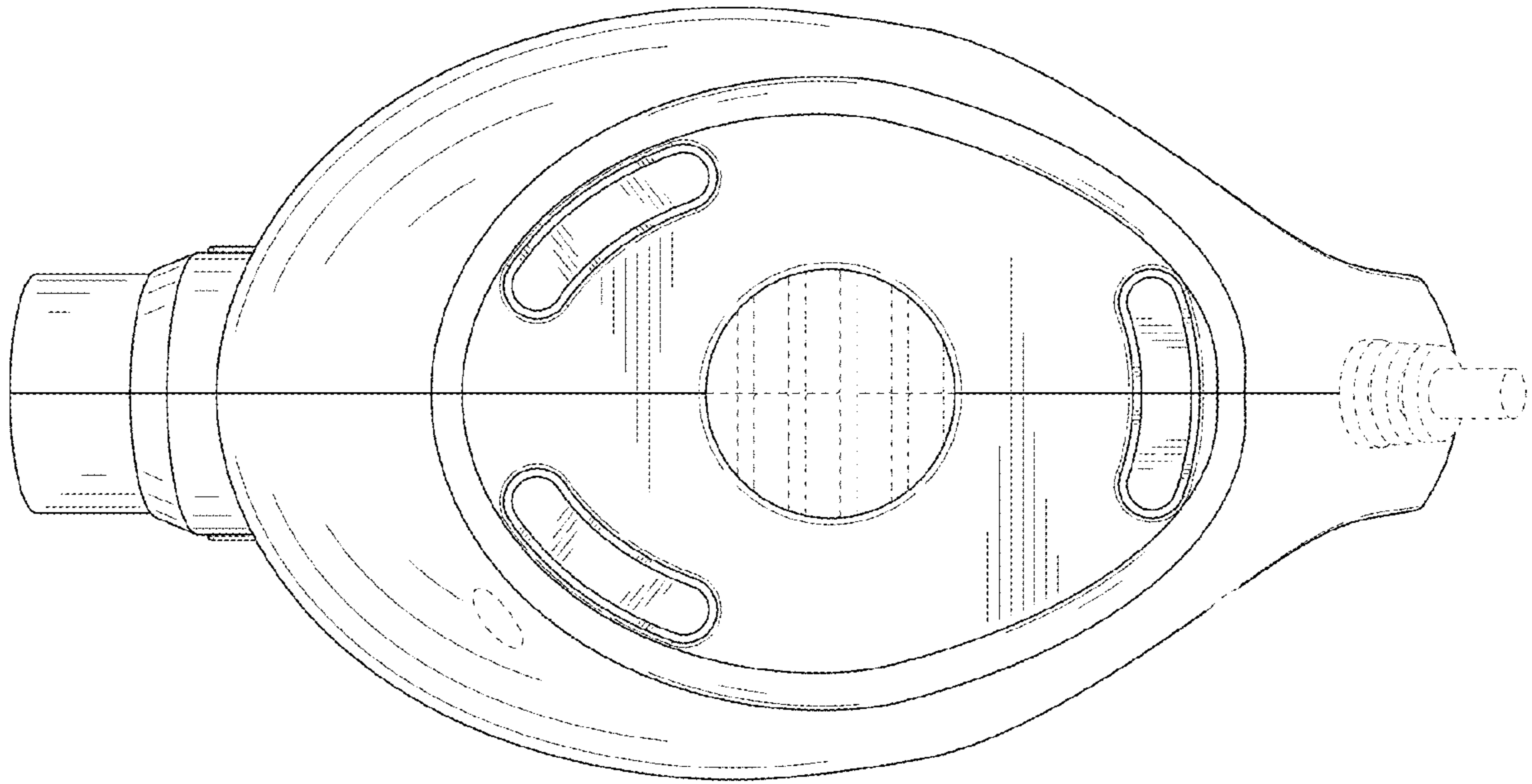

FIG. 24

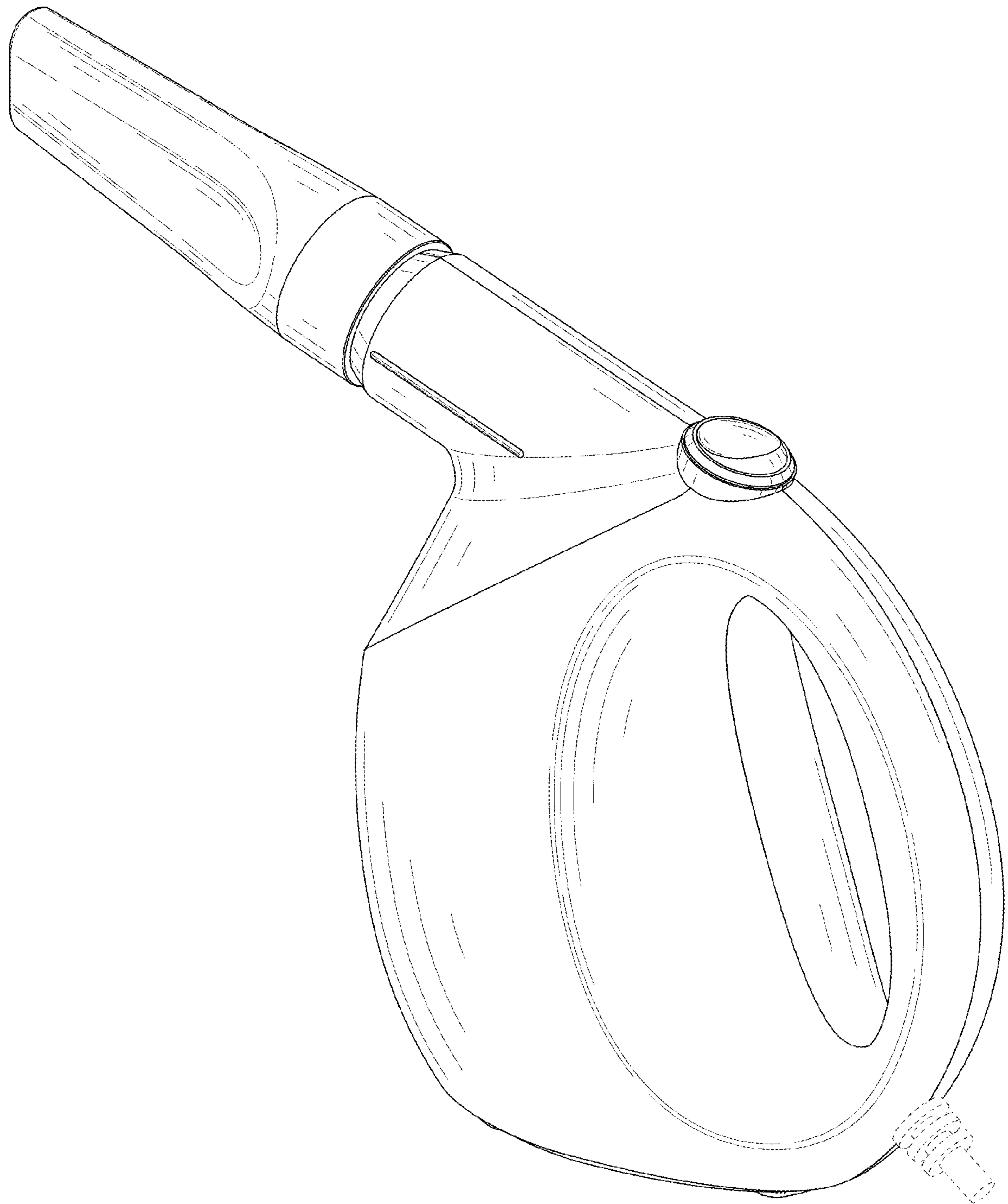

FIG. 25

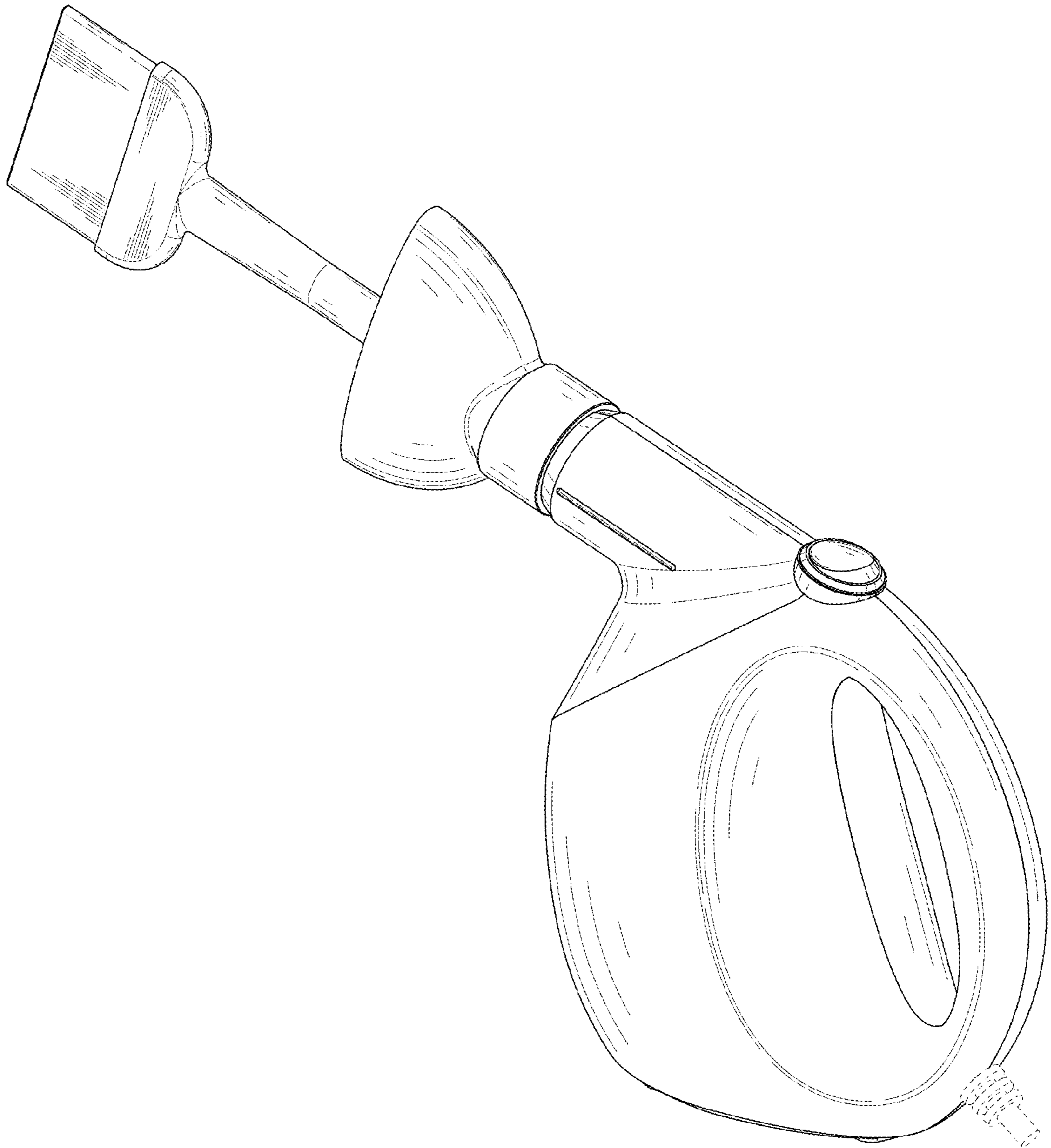

FIG. 26



FIG. 27