



US00D971393S

(12) **United States Design Patent**
Seo et al.

(10) **Patent No.:** **US D971,393 S**

(45) **Date of Patent:** **** Nov. 29, 2022**

(54) **HUMIDIFIER**

(71) Applicant: **MIRO CO., Ltd.**, Incheon (KR)

(72) Inventors: **Dong Jin Seo**, Seoul (KR); **Yong Ju Oh**, Incheon (KR); **Min Seok Kim**, Seoul (KR)

(73) Assignee: **MIRO CO., Ltd.**, Incheon (KR)

(**) Term: **15 Years**

(21) Appl. No.: **29/768,213**

(22) Filed: **Jan. 28, 2021**

(30) **Foreign Application Priority Data**

Aug. 19, 2020 (KR) 30-2020-0038774

(51) **LOC (13) Cl.** **23-04**

(52) **U.S. Cl.**
USPC **D23/356**

(58) **Field of Classification Search**
CPC .. A61L 9/16; A61L 9/22; B01D 47/00; B01D 47/027; B01D 2221/02; B01D 2259/4508; B03C 3/155; B03C 3/368; F24F 3/16; F24F 13/20; F24F 13/28
See application file for complete search history.

(56) **References Cited**

U.S. PATENT DOCUMENTS

D810,261 S * 2/2018 Chen D23/366
D810,262 S * 2/2018 Lu D23/366

D811,570 S * 2/2018 Tang D23/356
D813,367 S * 3/2018 Situ D23/366
D851,227 S * 6/2019 Chen D23/356
D857,870 S * 8/2019 Yang D23/366
D859,626 S * 9/2019 Hu D23/366
D885,548 S * 5/2020 Cui D23/366
D885,549 S * 5/2020 Cui D23/366
D897,512 S * 9/2020 Wu D23/356
D913,479 S * 3/2021 Yang D23/366
D939,070 S * 12/2021 Yang D23/356
D945,583 S * 3/2022 Chou D23/356

* cited by examiner

Primary Examiner — David G Muller

(74) *Attorney, Agent, or Firm* — Sughrue Mion, PLLC

(57) **CLAIM**

The ornamental design for an humidifier, as shown and described.

DESCRIPTION

FIG. 1 is a perspective view of an humidifier showing my new design;
FIG. 2 is a front view thereof;
FIG. 3 is a rear view thereof;
FIG. 4 is a left side view thereof;
FIG. 5 is a right side view thereof;
FIG. 6 is a top view thereof;
FIG. 7 is a bottom view thereof; and,
FIG. 8 is a view showing an example of use of the humidifier where an upper part is separated from a lower part.
The broken lines shown in the drawings are for the purpose of illustrating portions of the article and form no part of the claimed design.

1 Claim, 8 Drawing Sheets

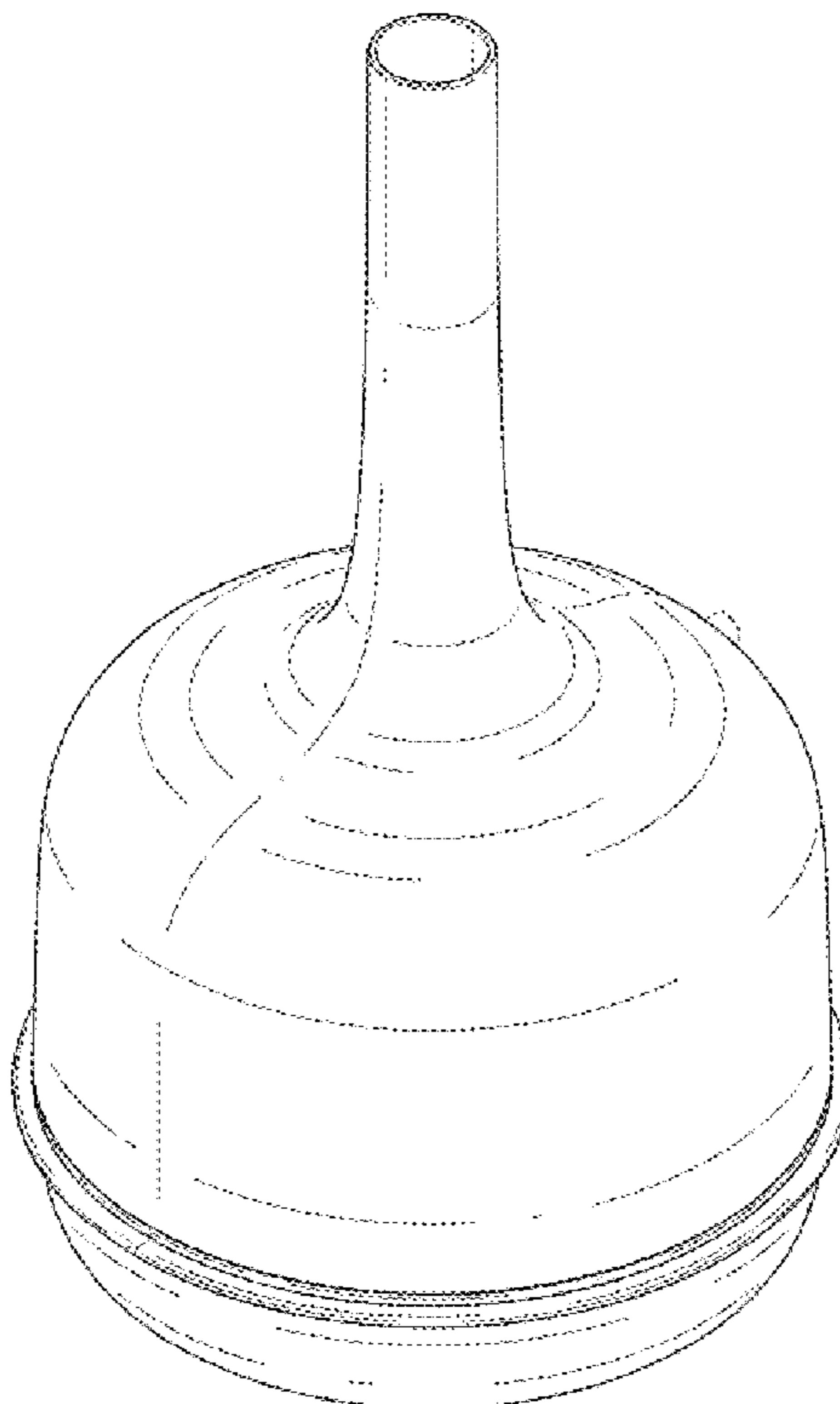

FIG. 1



FIG. 2

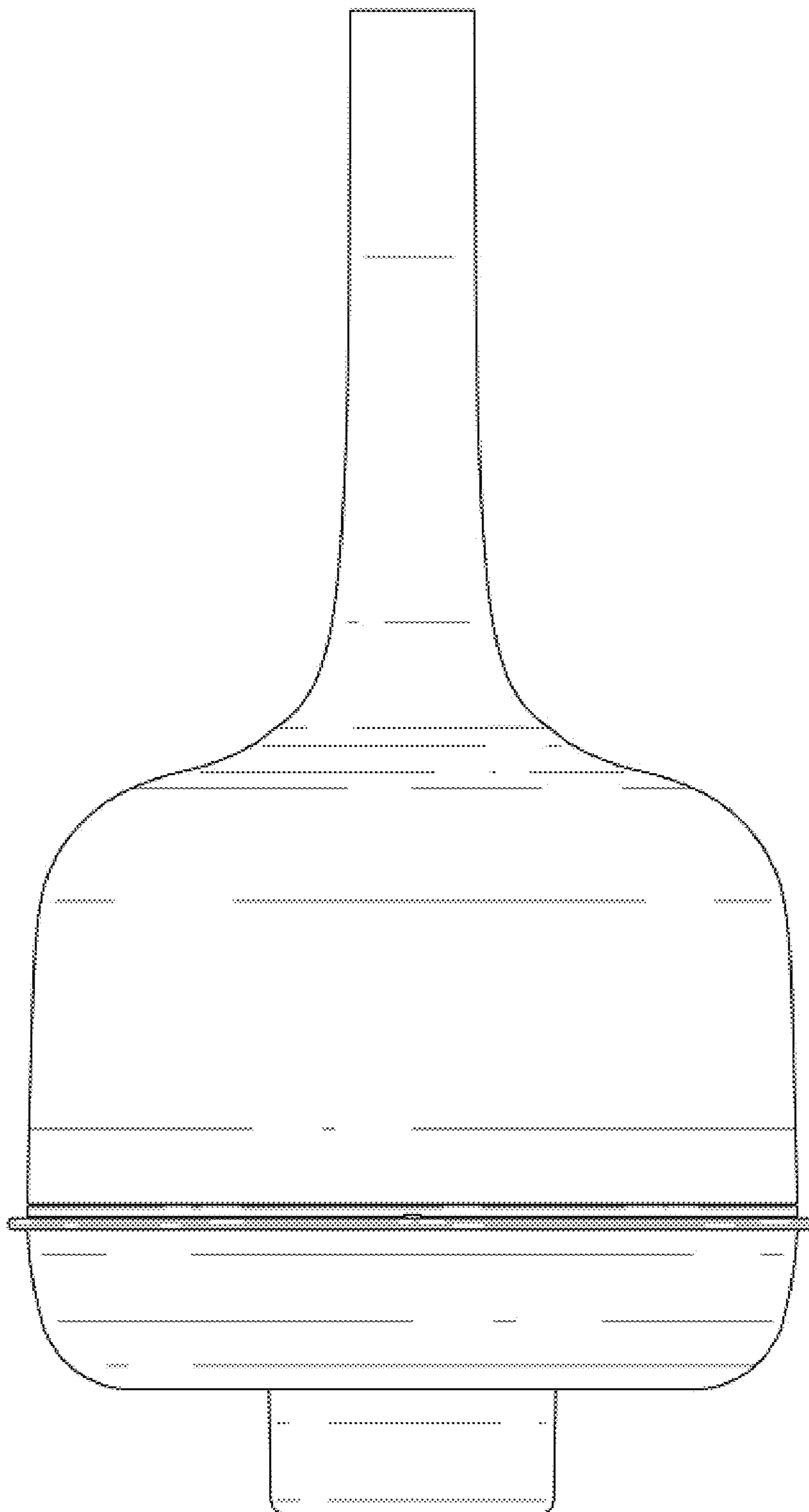

FIG. 3

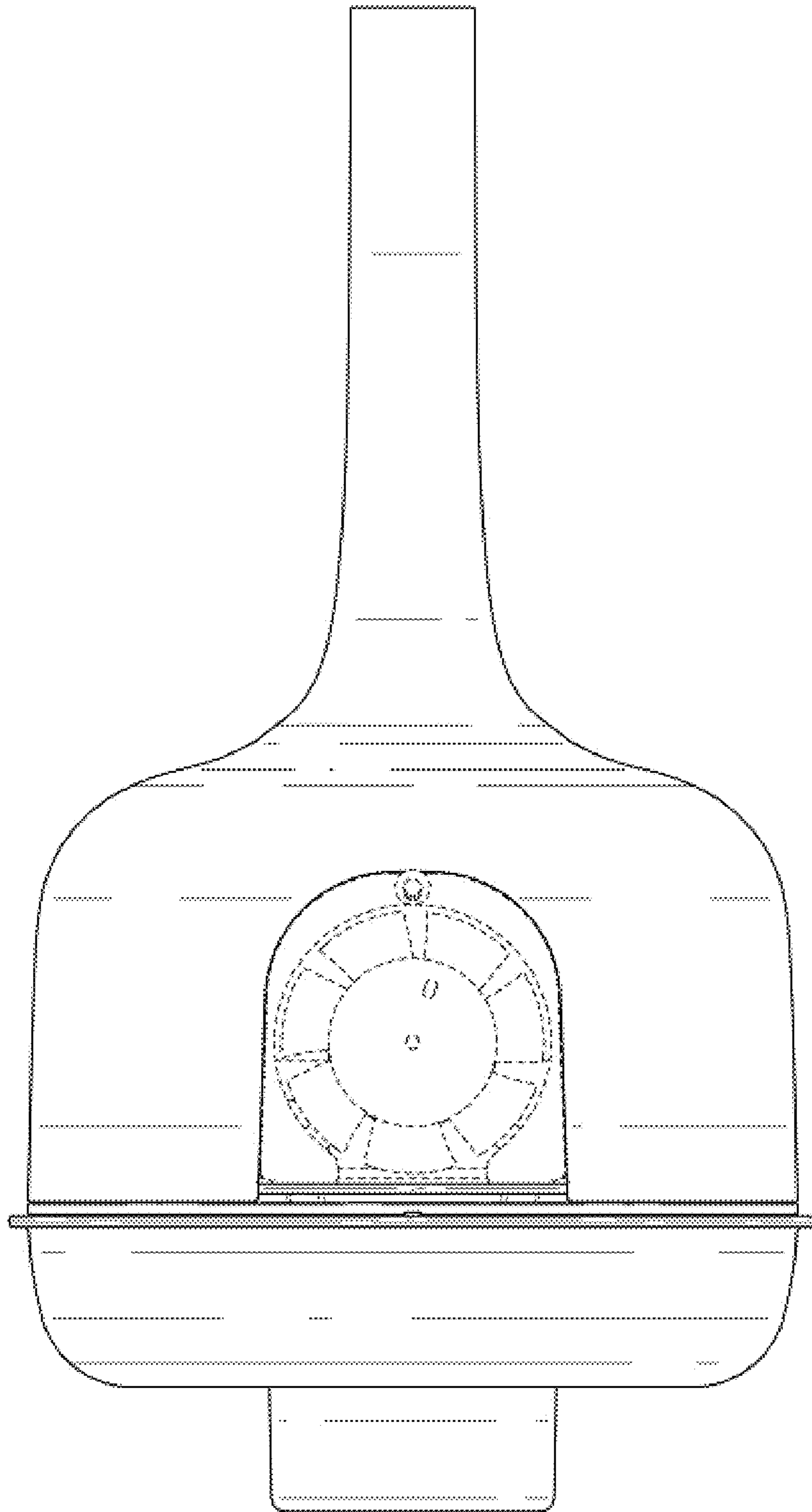

FIG. 4

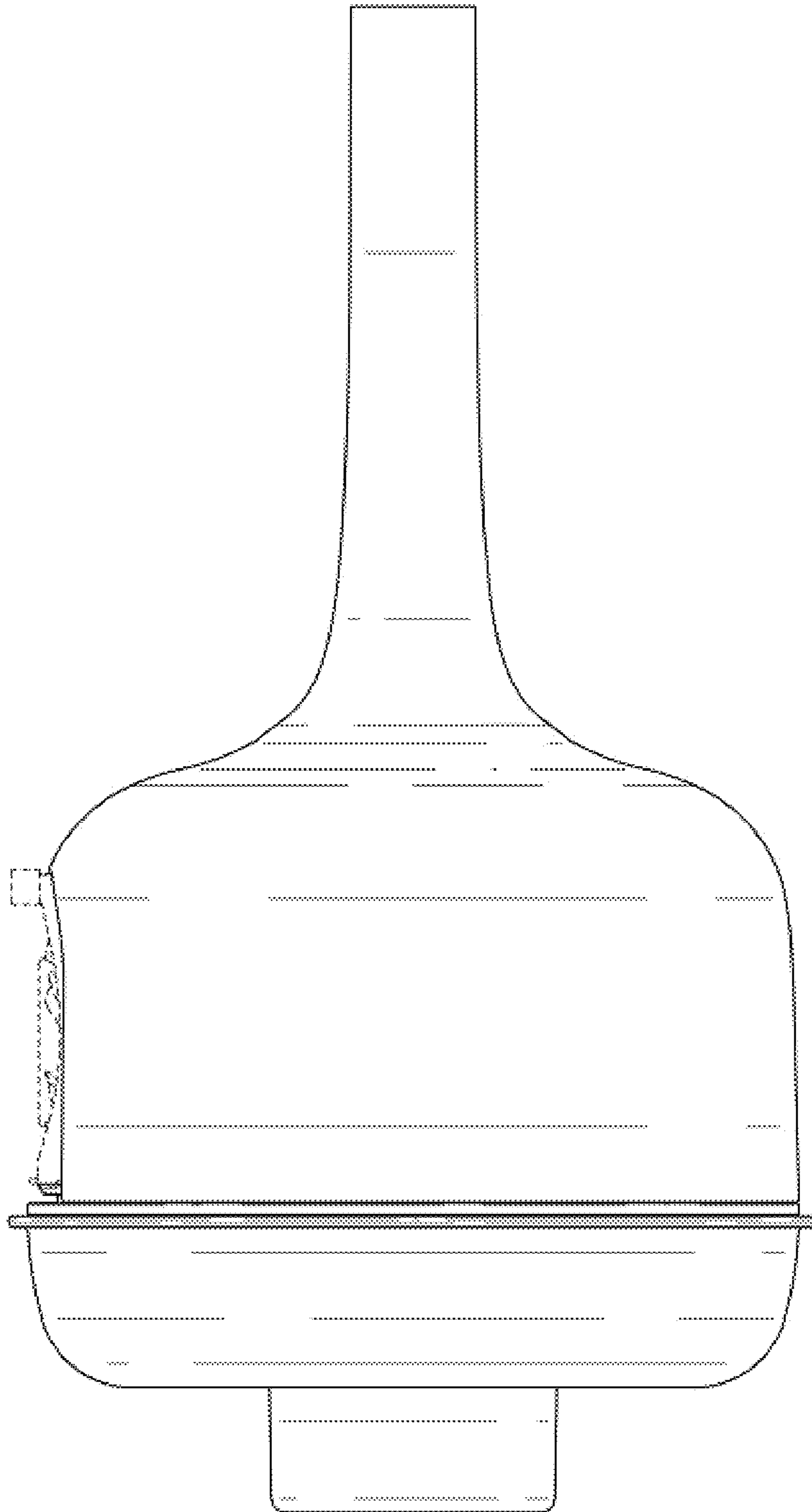

FIG. 5

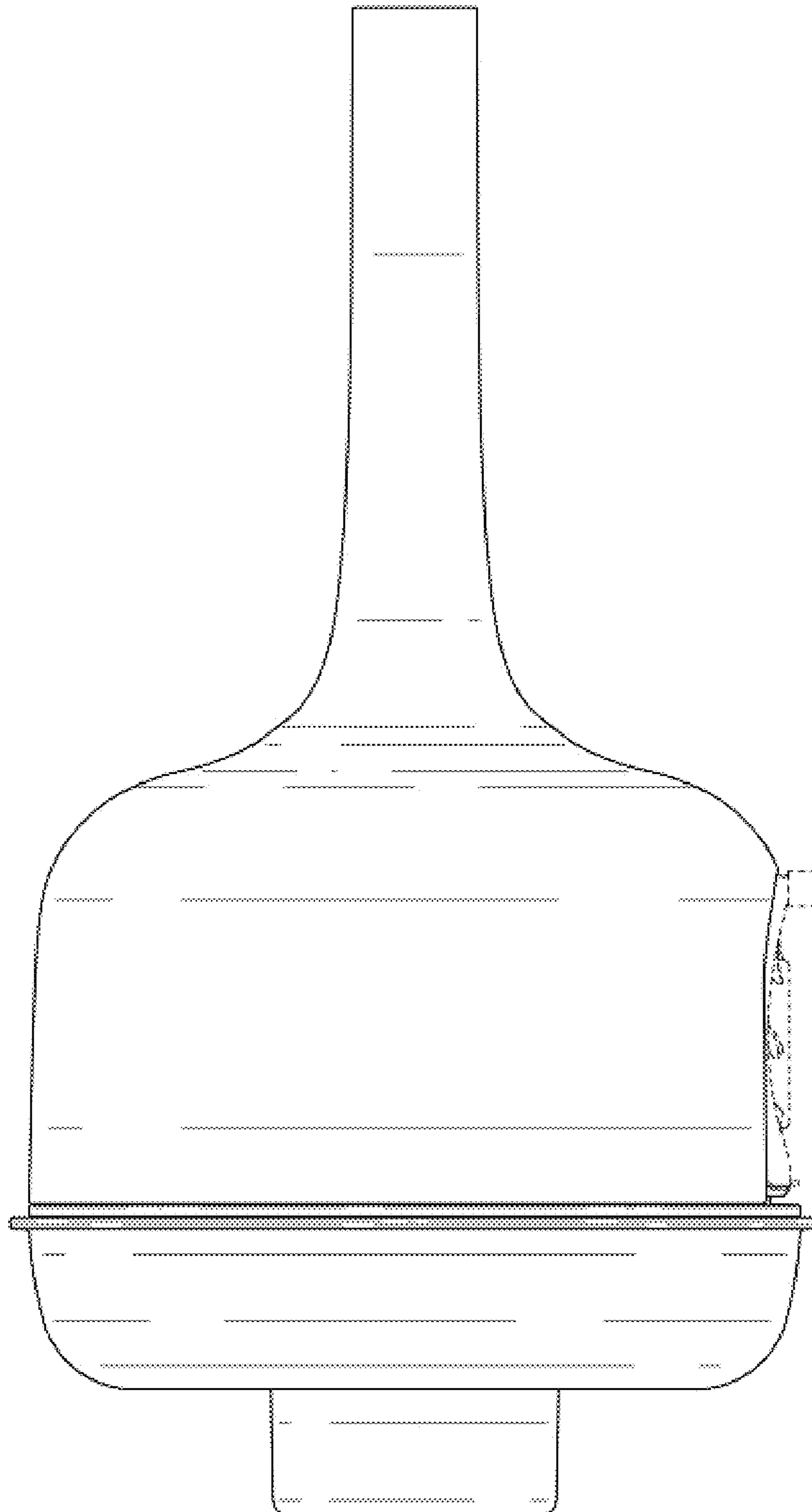

FIG. 6

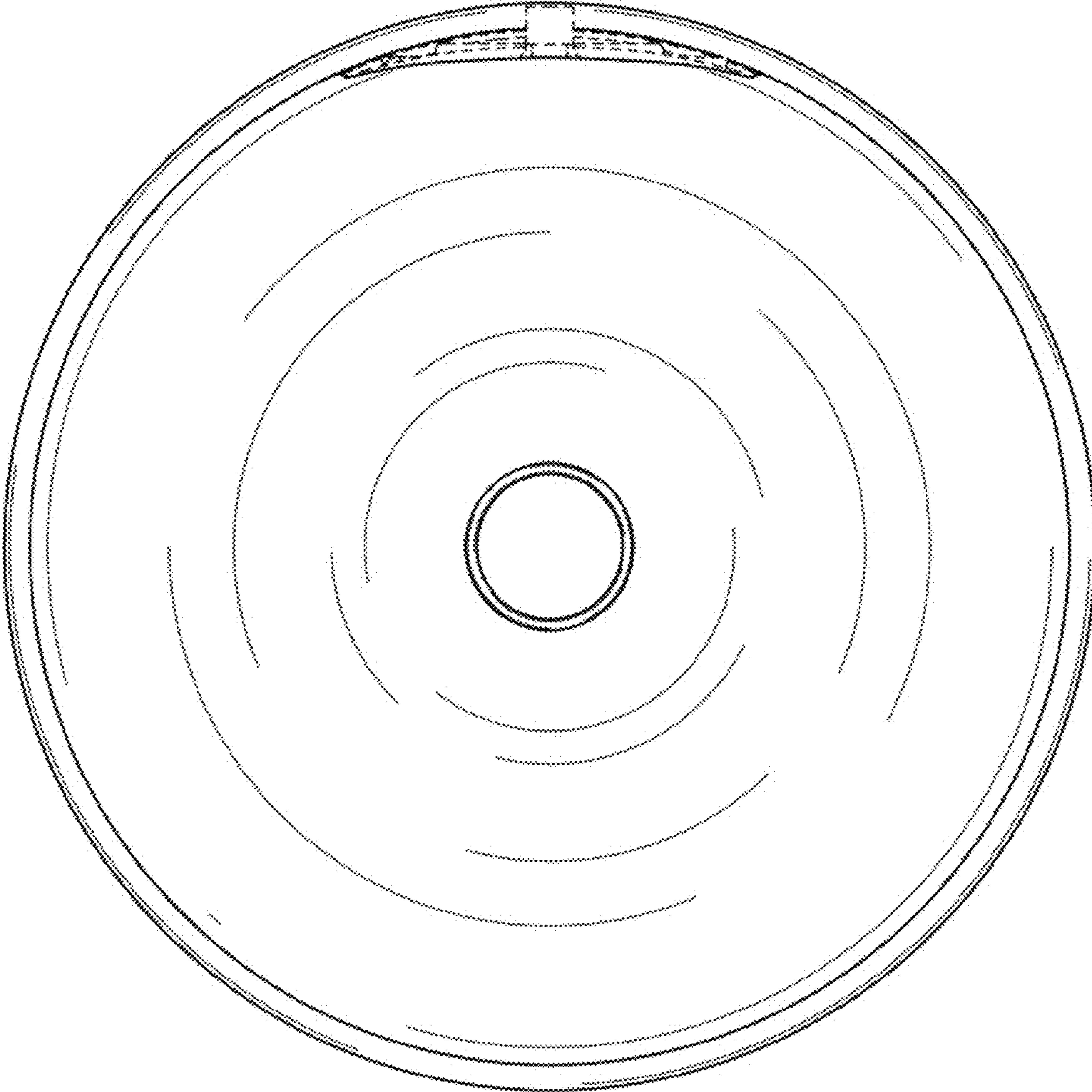

FIG. 7

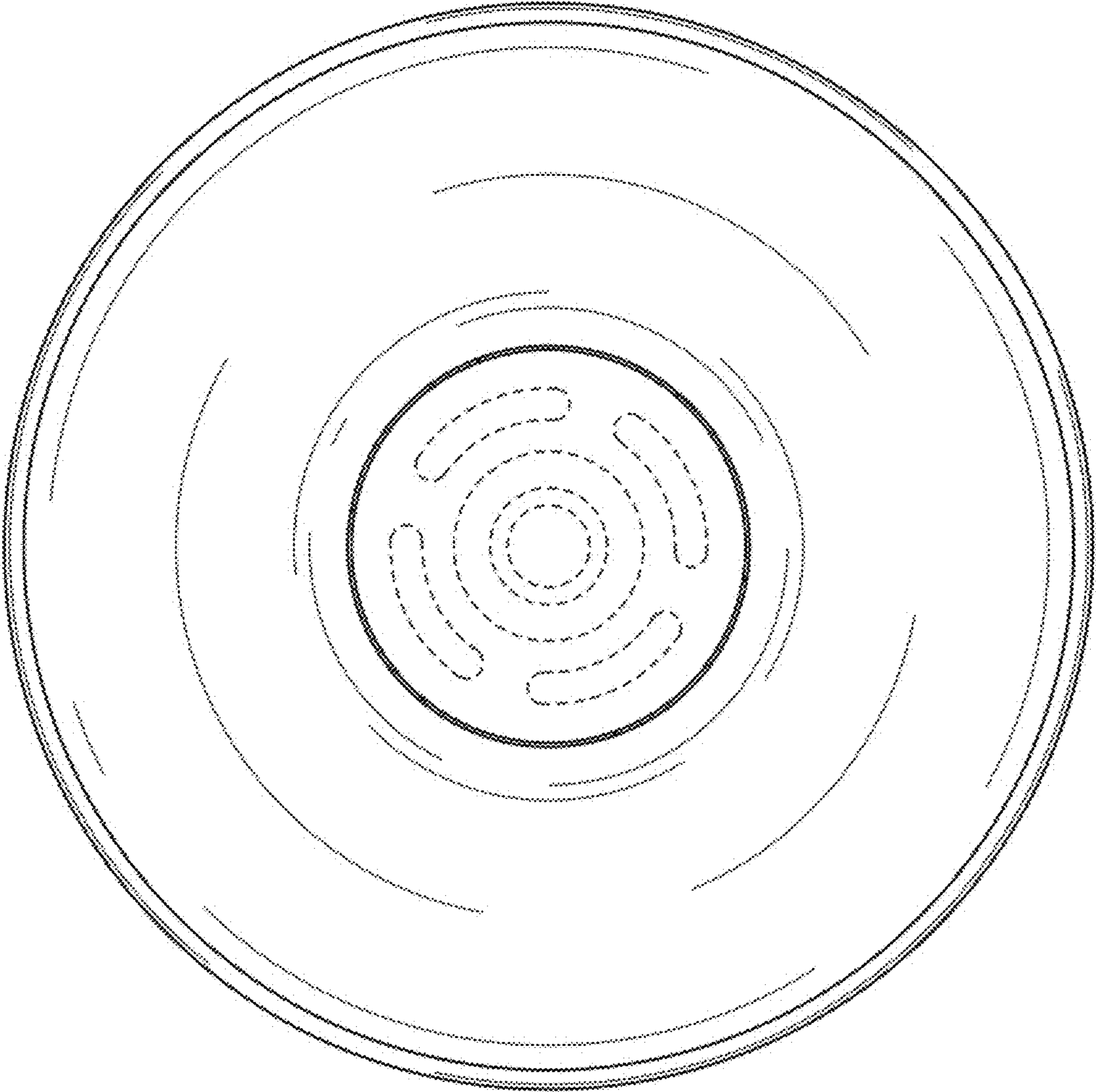

FIG. 8

