



US00D971377S

(12) **United States Design Patent** (10) **Patent No.:** **US D971,377 S**
Williams (45) **Date of Patent:** **** Nov. 29, 2022**

(54) **SHOWERHEAD**
(71) Applicant: **AS America, Inc.**, Piscataway, NJ (US)
(72) Inventor: **Emilie Williams**, New York, NY (US)
(73) Assignee: **AS America, Inc.**, Piscataway, NJ (US)
(**) Term: **15 Years**

D820,388 S * 6/2018 Seum D23/213
D851,207 S * 6/2019 Cocks D23/213
D888,195 S * 6/2020 Cocks D23/213
D907,743 S * 1/2021 Wu D23/213
D908,836 S * 1/2021 Wu D23/213
10,882,061 B2 * 1/2021 Nikles B05B 1/185
D914,134 S * 3/2021 Eads D23/213
10,945,059 B2 * 3/2021 Hanna H04R 1/026
10,946,395 B2 * 3/2021 Medeiros B05B 1/185
11,014,101 B2 * 5/2021 Zhuo B05B 15/5225

(Continued)

(21) Appl. No.: **29/768,463**

(22) Filed: **Jan. 29, 2021**

(51) **LOC (13) Cl.** **21-01**

(52) **U.S. Cl.**
USPC **D23/213**

(58) **Field of Classification Search**
USPC D23/213, 214, 215, 223, 224, 226, 229,
D23/230
CPC A61H 9/0021; A61H 33/00; B05B 1/00;
B05B 1/14; B05B 1/185; B05B 1/08;
B05B 1/02; B05B 1/26; B05B 12/002;
B05B 1/18; B05B 9/01
See application file for complete search history.

(56) **References Cited**

U.S. PATENT DOCUMENTS

D514,197 S * 1/2006 Gilbert D23/229
D549,302 S * 8/2007 Haug D23/213
D556,855 S * 12/2007 Mullenmeister D23/213
D593,640 S * 6/2009 Schoenherr D23/213
D639,385 S * 6/2011 Flowers D23/213
D681,781 S * 5/2013 Cutler D23/229
D694,357 S * 11/2013 Brodey D23/213
D694,359 S * 11/2013 Schoenherr D23/213
D707,328 S * 6/2014 Schoenherr D23/213
D733,257 S * 6/2015 Schoenherr D23/213
D738,991 S * 9/2015 Brodey D23/213
D751,175 S * 3/2016 Schoenherr D23/213
D751,176 S * 3/2016 Schoenherr D23/213
D752,708 S * 3/2016 Chung D23/213
D779,042 S * 2/2017 Hanna D23/229

OTHER PUBLICATIONS

Moen S176EPBG Collection 7-Inch Single Function Eco Performance Shower Head, Jun. 1, 2018, Amazon.com, Sep. 1, 2022, URL: https://www.amazon.com/dp/B07H581BD8/ref=sbl_dp_x_B088V6N9HK_0 (Year: 2018).*

(Continued)

Primary Examiner — Keith J Wilson
(74) *Attorney, Agent, or Firm* — Tyler A. Stevenson;
Anna-lisa L. Gallo

(57) **CLAIM**

I claim the ornamental design for a showerhead, as shown and described.

DESCRIPTION

FIG. 1 is a bottom perspective view of a showerhead showing my new design;
FIG. 2 is a front view thereof;
FIG. 3 is a rear view thereof;
FIG. 4 is a left side view thereof;
FIG. 5 is a right side view thereof;
FIG. 6 is a bottom view thereof;
FIG. 7 is a top view thereof; and,
FIG. 8 is a top perspective view thereof.
Broken lines of the disclosure represent portions of the showerhead that form no part of the claimed design.

1 Claim, 6 Drawing Sheets

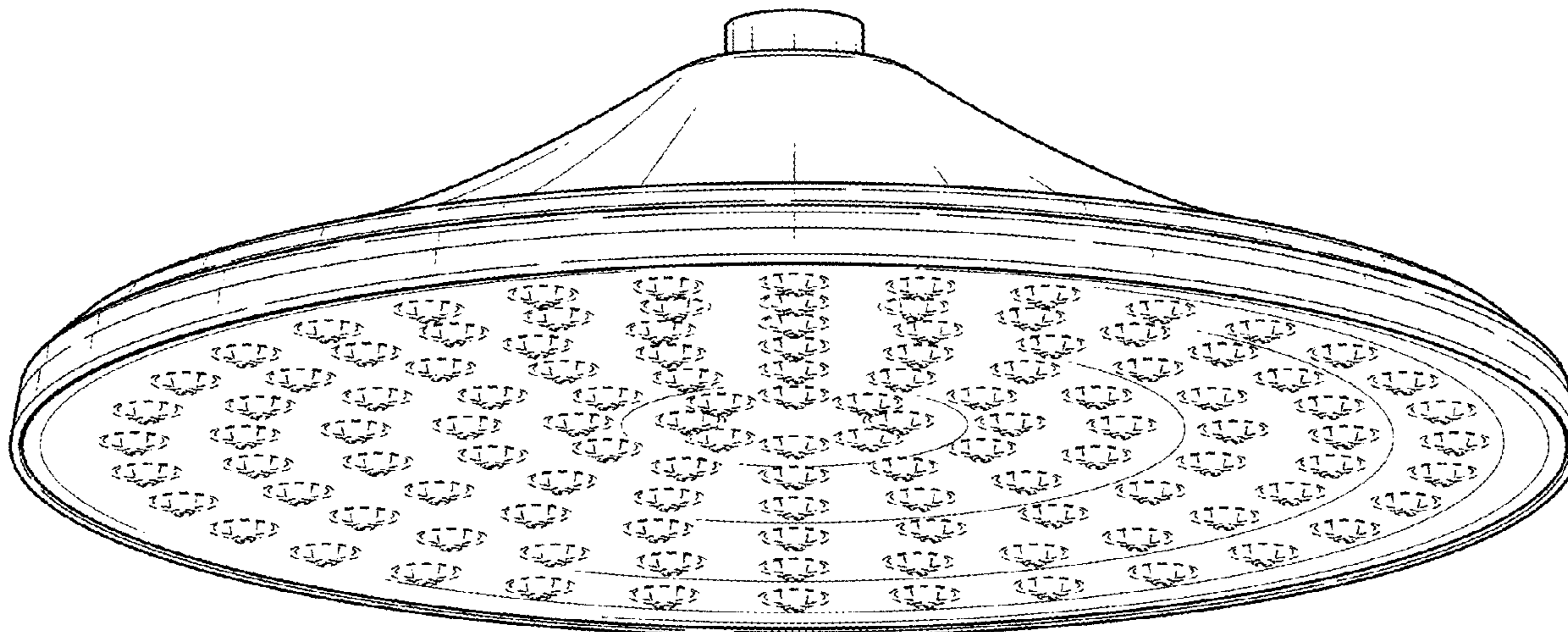

(56)

References Cited

U.S. PATENT DOCUMENTS

11,014,115 B2 * 5/2021 Huang B05B 1/18
D922,522 S * 6/2021 Lin D23/213
D934,990 S * 11/2021 Seum D23/213
D934,994 S * 11/2021 Fantini D23/213
D936,178 S * 11/2021 Lin D23/213
11,179,735 B2 * 11/2021 Wu B05B 1/3026
D944,919 S * 3/2022 Yu D23/213
2005/0284967 A1 * 12/2005 Korb B05B 1/185
239/600

OTHER PUBLICATIONS

Moen S112BG Collection 10-Inch Single Function Showerhead,
Jun. 1, 2020, Amazon.com, Sep. 1, 2022, URL: https://www.amazon.com/dp/B088V6N9HK/ref=sbl_dp_B07H581BD8_0 (Year: 2020).*

ShowerMaxx, Elite Series, 9 inch Round High Pressure Rainfall
Shower Head, Aug. 9, 2018, Amazon.com, Sep. 1, 2022, URL:
<https://www.amazon.com/ShowerMaxx-MAXX-imize-Experience-Restrictor-Showerhead/dp/B07GBHQT29> (Year: 2018).*

Rainfall Shower Head—8 Inch Large Overhead Rain Showerhead,
Aug. 2, 2019, amazon.ca, Sep. 7, 2022 <https://www.amazon.ca/dp/B07NVTGPN4/> (Year: 2019).*

* cited by examiner

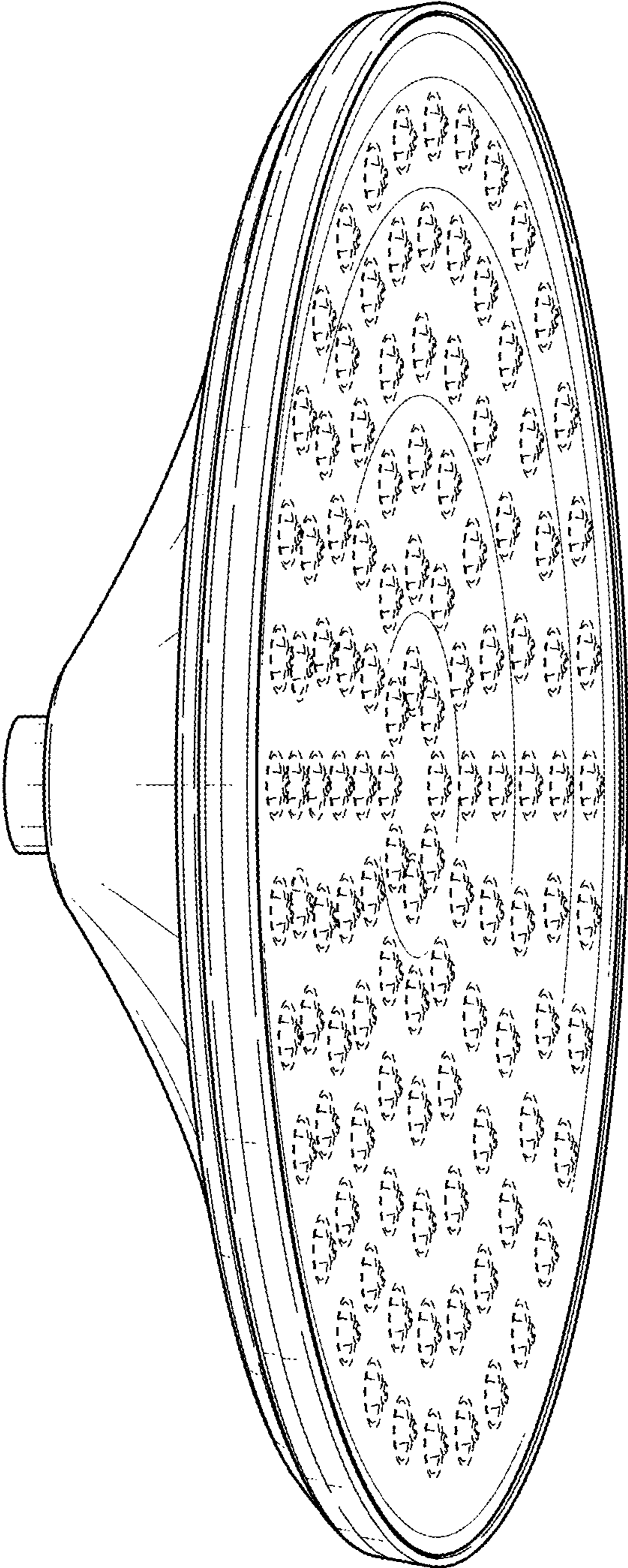

FIG. 1

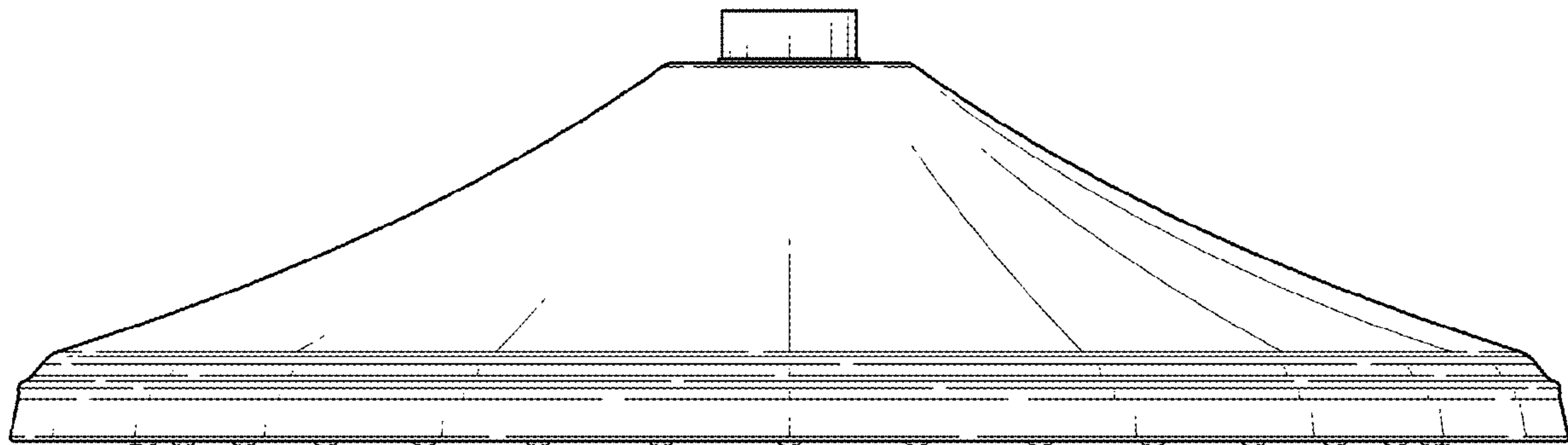

FIG. 2

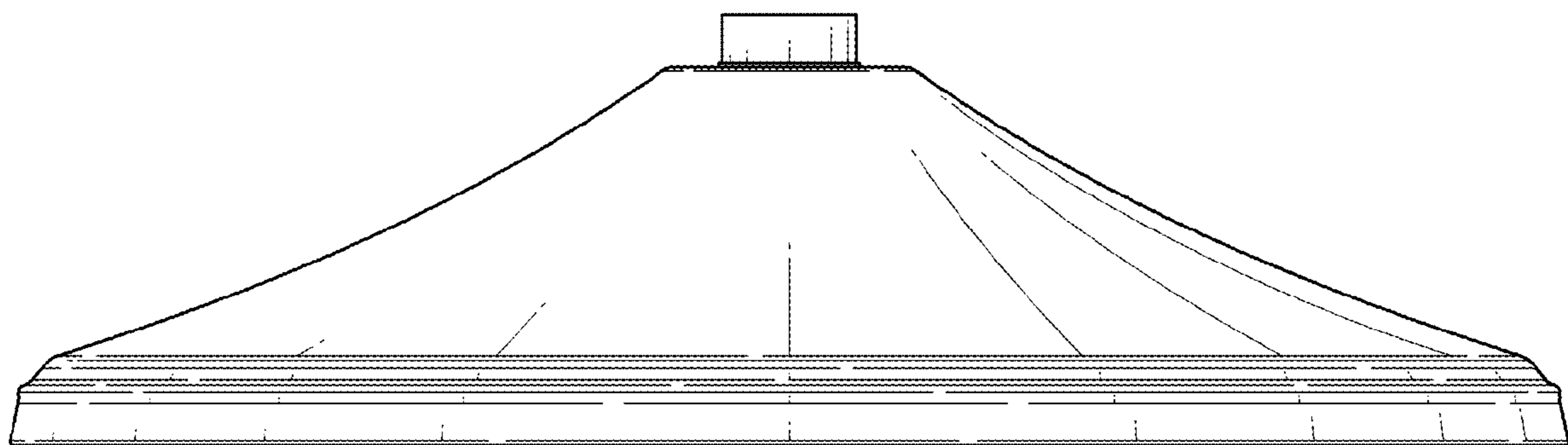

FIG. 3

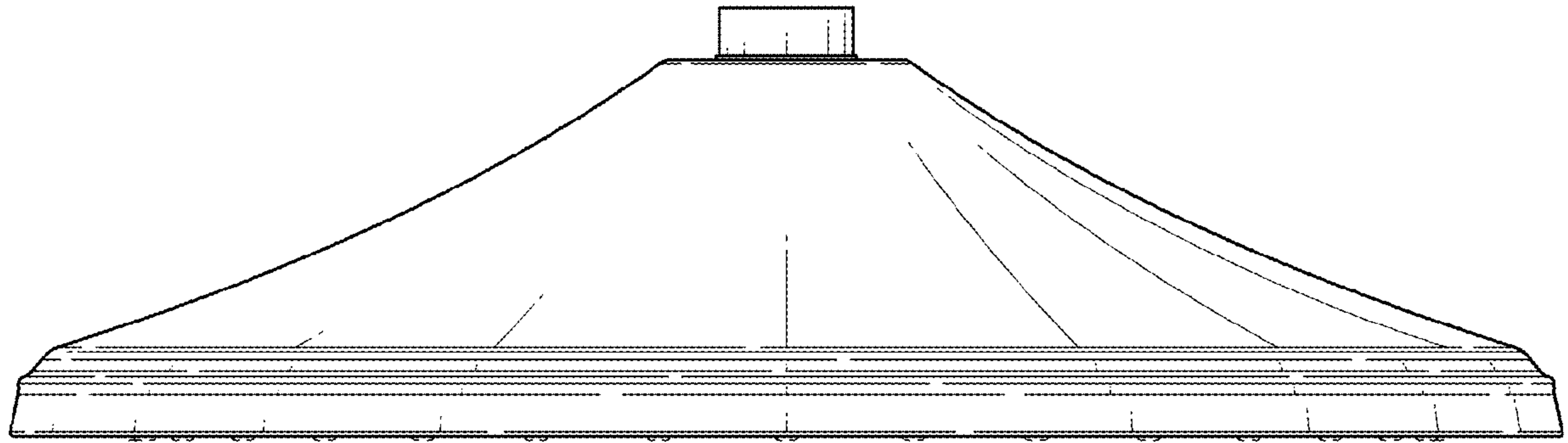

FIG. 4

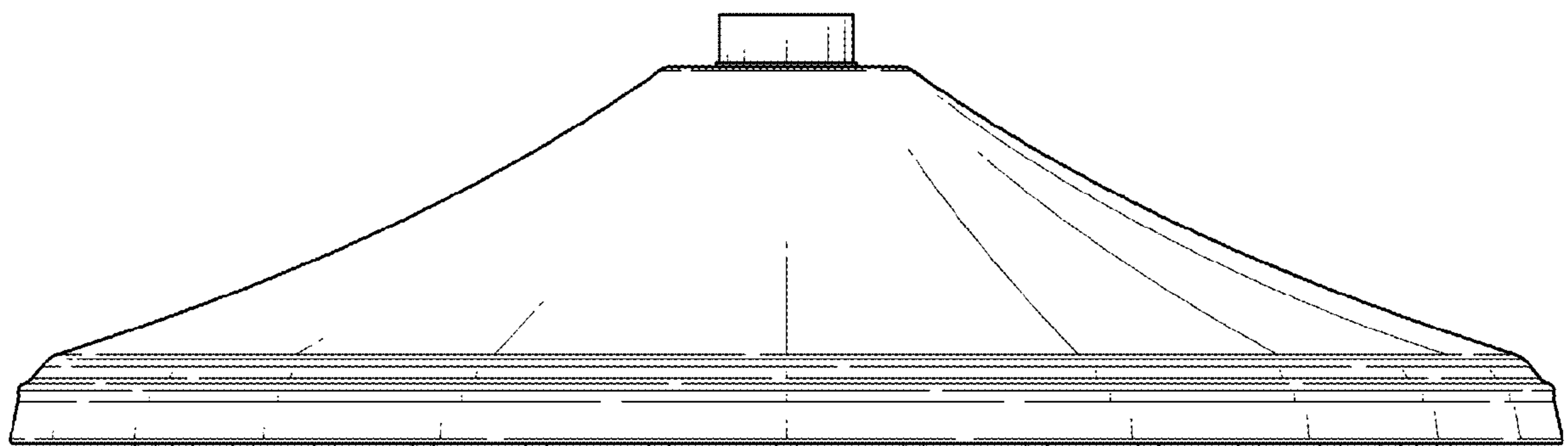

FIG. 5

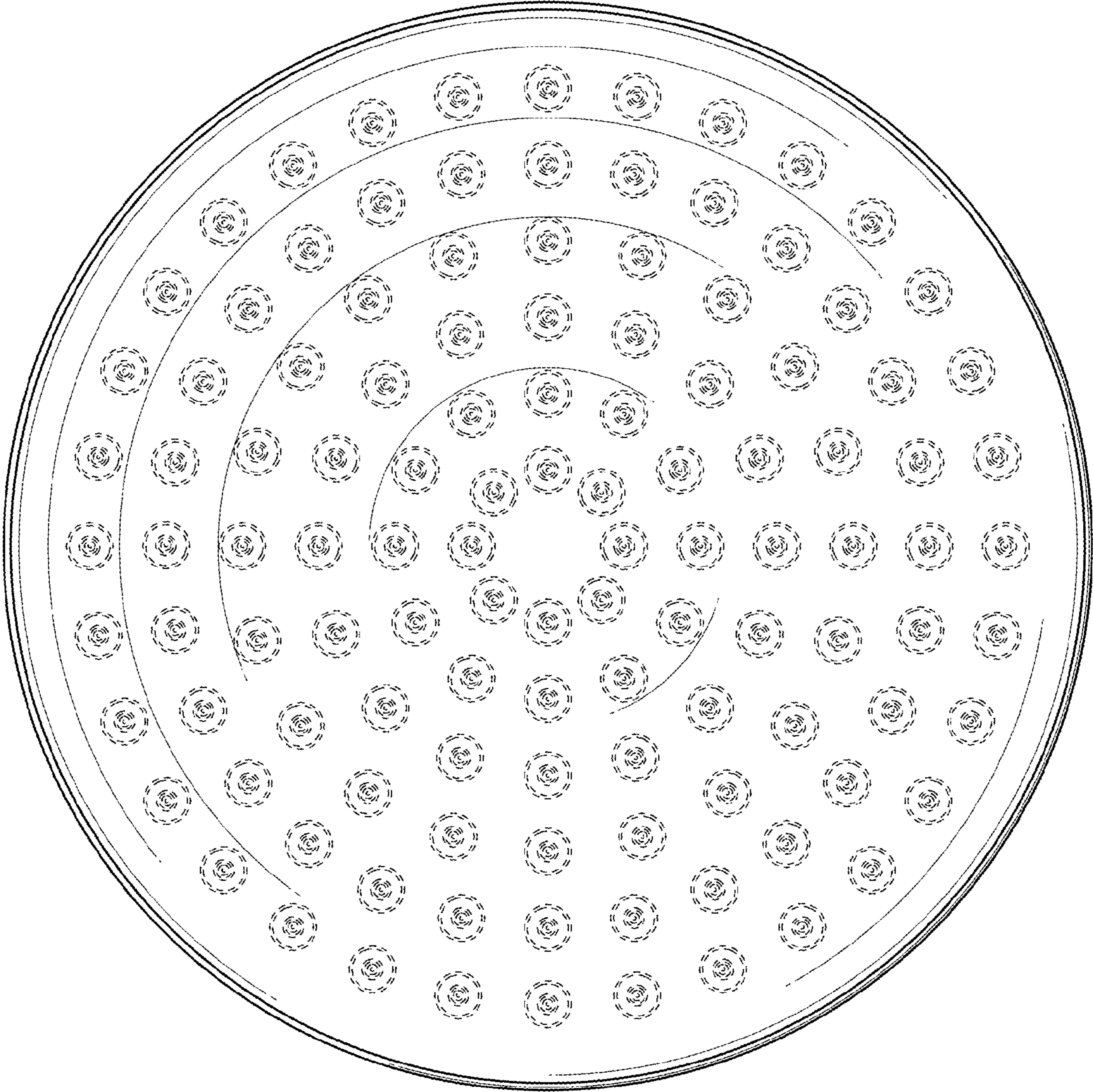

FIG. 6

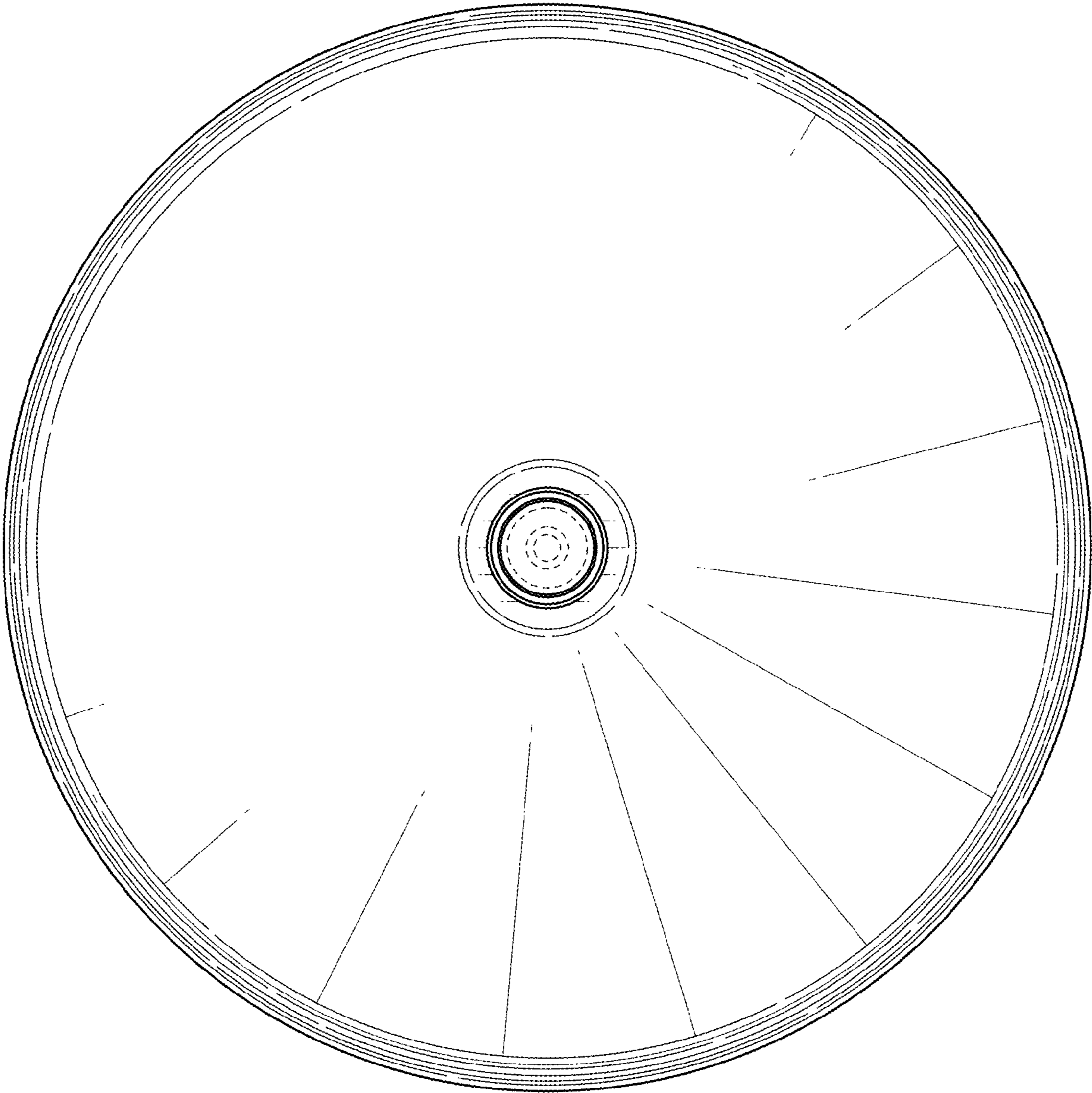

FIG. 7

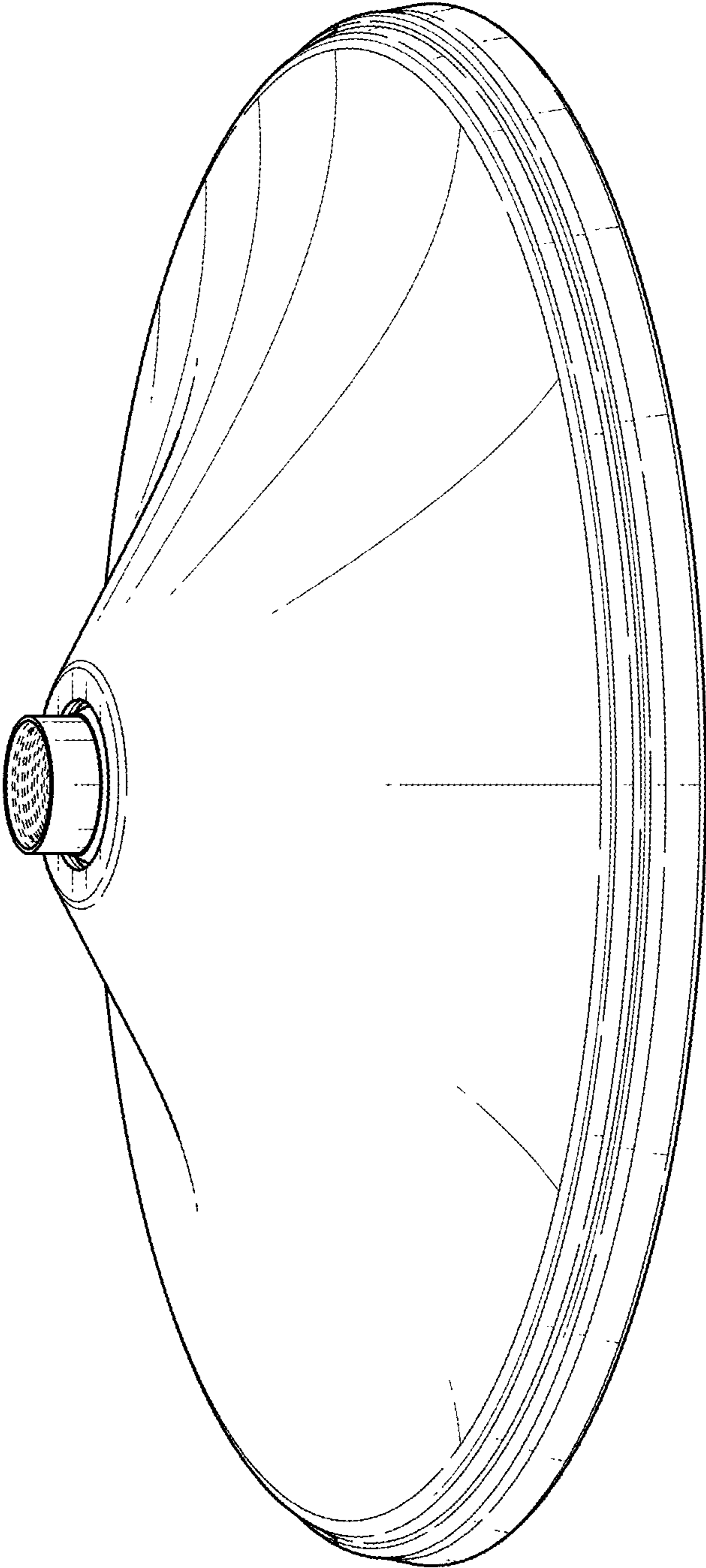

FIG. 8