



US00D971322S

(12) **United States Design Patent** (10) **Patent No.:** **US D971,322 S**  
**Ward** (45) **Date of Patent:** **\*\* Nov. 29, 2022**

(54) **PEN**

FOREIGN PATENT DOCUMENTS

(71) Applicant: **Richard James Ward**, Boston, MA (US)

CN 305512288 \* 12/2019  
RU 00118198 \* 12/2019

(72) Inventor: **Richard James Ward**, Boston, MA (US)

OTHER PUBLICATIONS

(73) Assignee: **Richard James Ward**, Nuremberg (DE)

Calligraphygifts,TinEye.com,pictaram.com,date published Jan. 14, 2017,date retrieved from internet Mar. 21, 2022—29761458—https://tineye.com/search/4bd99bce0637aa977b5d118080f8d0f2459920eb?sort=score&order=desc&page=1 (Year: 2017).\*

(\*\*) Term: **15 Years**

Wood Dip Pen by Elegant Woodworking Gifts,CustomMade.com,date reviewed Apr. 10, 2019,date retrieved from internet Mar. 21, 2022—29761458—https://www.custommade.com/dip-pen/by/elegantwoodworkinggifts/ (Year: 2019).\*

(21) Appl. No.: **29/761,458**

(22) Filed: **Dec. 9, 2020**

(51) **LOC (13) Cl.** ..... **19-06**

\* cited by examiner

(52) **U.S. Cl.**  
USPC ..... **D19/186**

*Primary Examiner* — Jennifer L Rempfer

(58) **Field of Classification Search**  
USPC ..... D19/115–185; D14/431  
CPC ..... G06F 3/0383; G06F 3/03545  
See application file for complete search history.

*Assistant Examiner* — Danielle Nichole Bowly

(74) *Attorney, Agent, or Firm* — Saul Ewing Arnstein & Lehr LLP; Brian R. Landry

(56) **References Cited**

(57) **CLAIM**

U.S. PATENT DOCUMENTS

The ornamental design of a pen design, as shown and described.

D158,946 S *	6/1950	Duelfer	.....	D19/931
D175,864 S *	10/1955	Steinberg et al.	.....	D19/186
D288,825 S *	3/1987	Thompson	.....	D19/174
D289,304 S *	4/1987	Giugiaro	.....	D19/916
D369,830 S *	5/1996	Hadtke	.....	D19/933
D412,183 S *	7/1999	Stukenkemper	.....	D19/174
D429,280 S *	8/2000	Mittersinker	.....	D19/179
D464,675 S *	10/2002	Wang	.....	D19/180
D582,982 S *	12/2008	Richards	.....	D19/920
D597,134 S *	7/2009	Lin	.....	D7/643
D638,472 S *	5/2011	Hung	.....	D19/906
D660,911 S *	5/2012	Uchiyama	.....	D19/175
D740,364 S *	10/2015	Vadenne	.....	D19/177
D857,797 S *	8/2019	Pisapia	.....	D19/186
D857,798 S *	8/2019	Pisapia	.....	D19/186
2012/0274680 A1 *	11/2012	Hofman	.....	G06F 3/03545 346/139 C

**DESCRIPTION**

FIG. 1 is a perspective view of the front, left, and top side of a pen showing an embodiment of the new design. FIG. 2 is a front view thereof. FIG. 3 is a rear view thereof. FIG. 4 is a right view thereof. FIG. 5 is a left view thereof. FIG. 6 is a top view thereof; and, FIG. 7 is a bottom view thereof. The broken lines show portions of the article that form no part of the claimed design.

**1 Claim, 6 Drawing Sheets**

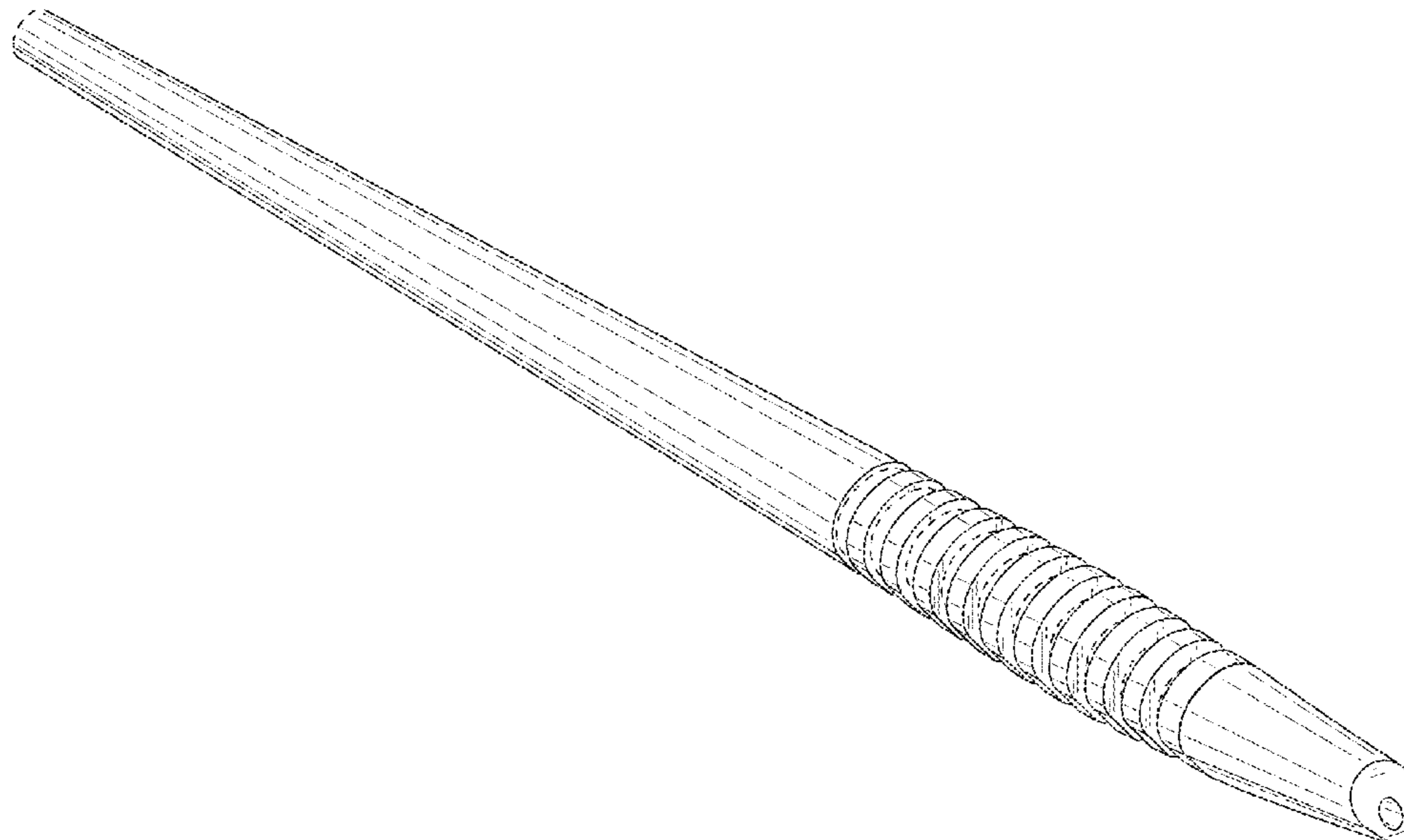

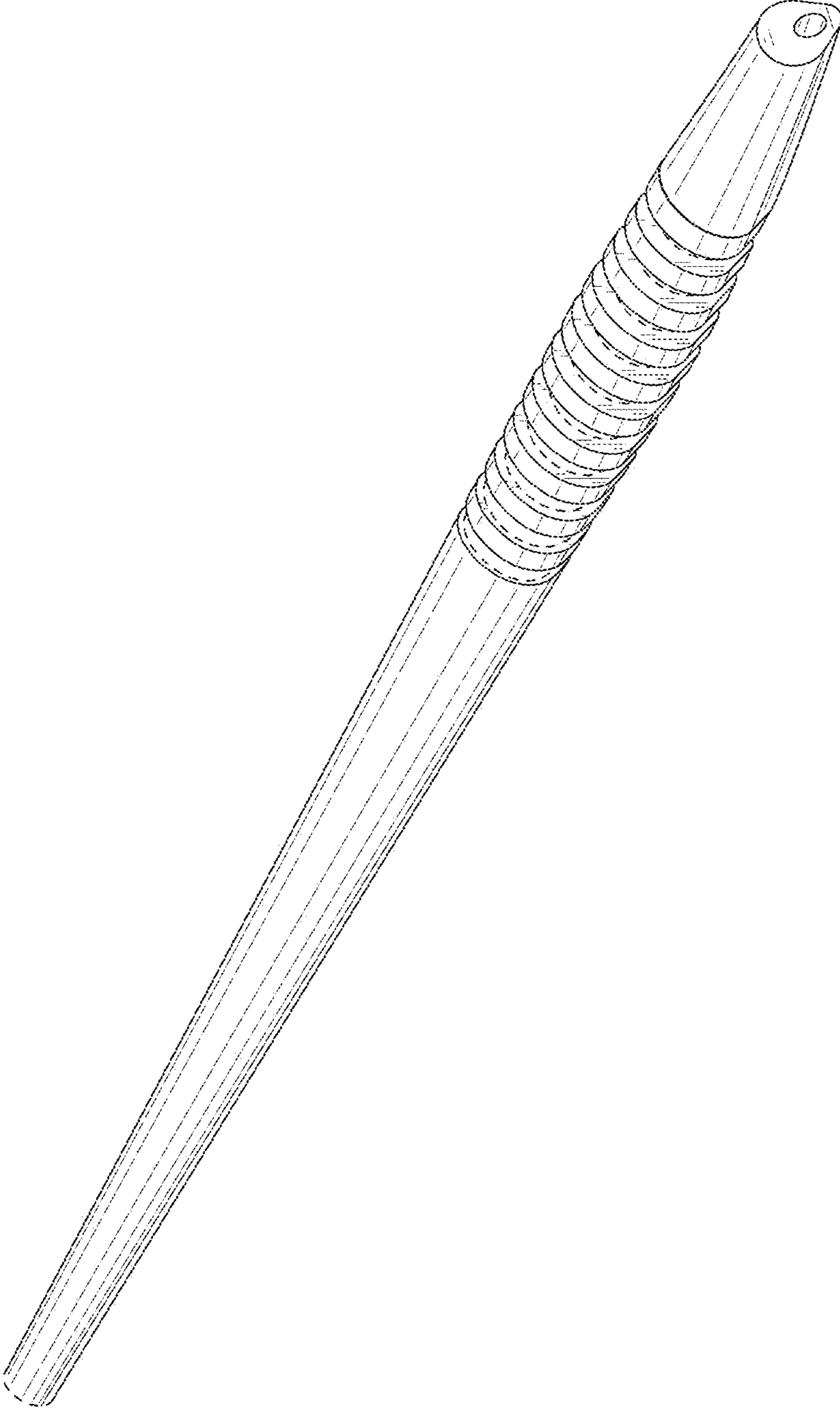

FIG. 1

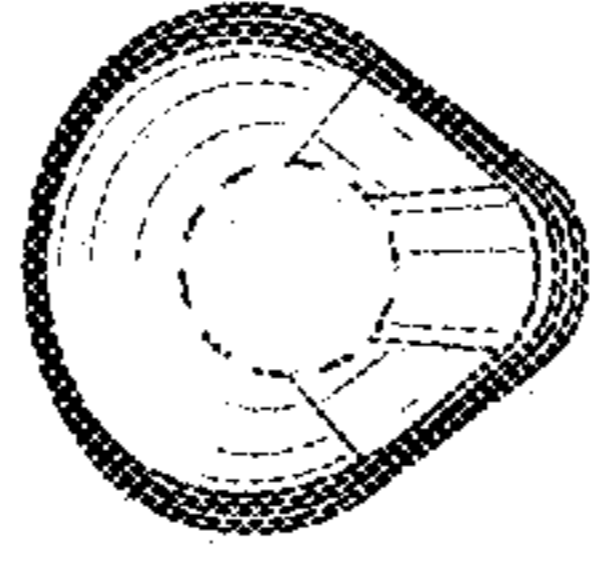

FIG. 3

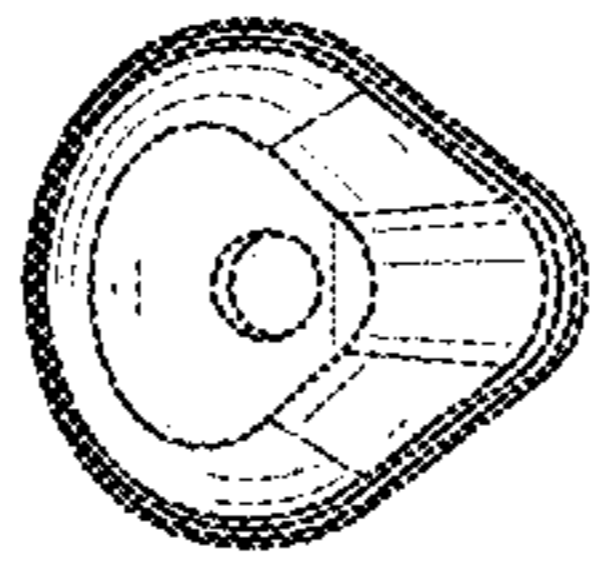

FIG. 2

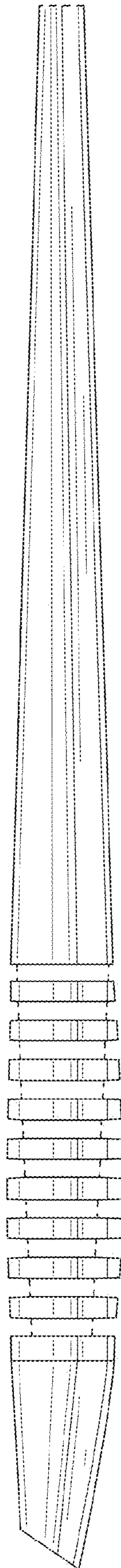

FIG. 4

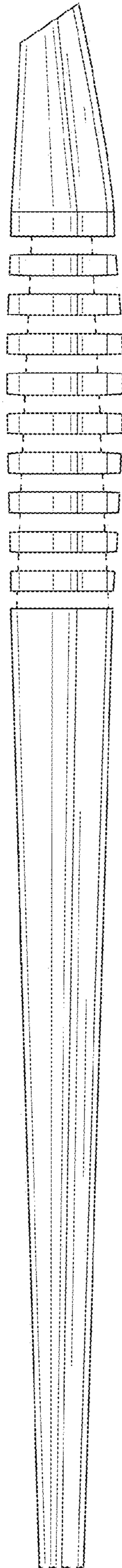

FIG. 5

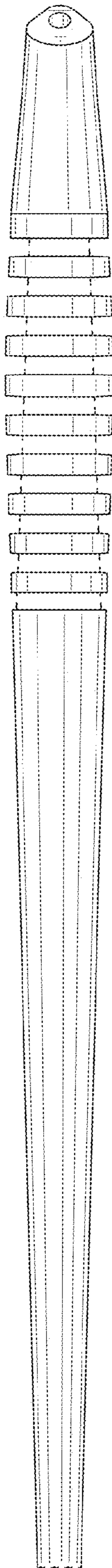

FIG. 6

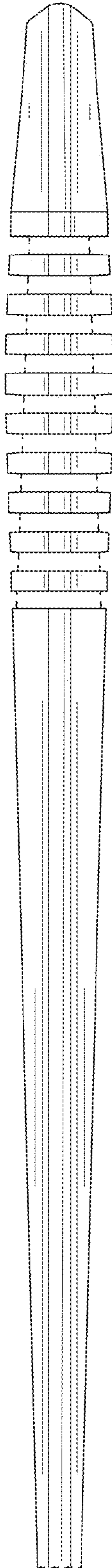

FIG. 7