



US00D971265S

(12) **United States Design Patent** (10) **Patent No.:** **US D971,265 S**  
**Yu** (45) **Date of Patent:** **\*\* Nov. 29, 2022**

(54) **AIR PUMP**

OTHER PUBLICATIONS

(71) Applicant: **QingLan Yu**, Sichuan (CN)

Master Airbrush, Airbrush Depot TC-16-H 1/8 HP Mini Air Compressor, (site visited Jul. 11, 2022), Walmart.com, URL:<https://www.walmart.com/ip/Airbrush-Depot-TC-16-H-1-8-HP-Mini-Air-Compressor-110-Volt-Unit-with-a-Free-6/41978601> (Year: 2022).\*

(72) Inventor: **QingLan Yu**, Sichuan (CN)

AcmyslaT, Electric Balloon Pump Kit600W, (site visited Jul. 11, 2022), Amazon.com, URL:<https://www.amazon.com/AcmyslaT-Electric-Elephant-Christmas-Decoration/dp/B09M6M1BVX> (Year: 2022).\*

(\*\*) Term: **15 Years**

Bompow, Electric Pump for Inflatables Air Mattress, (date first available Jan. 27, 2019), Amazon.com, URL:<https://www.amazon.com/Electric-Inflatables-Mattress-Quick-Black/dp/B07N651HF6> (Year: 2019).\*

(21) Appl. No.: **29/797,844**

(22) Filed: **Jul. 2, 2021**

(30) **Foreign Application Priority Data**

Feb. 2, 2021 (CN) ..... 202130075736.6

\* cited by examiner

(51) **LOC (13) Cl.** ..... **15-02**

*Primary Examiner* — Calvin E Vansant

(52) **U.S. Cl.**

*Assistant Examiner* — Mark T. Philipps

USPC ..... **D15/7**

(74) *Attorney, Agent, or Firm* — Wayne IP LLC

(58) **Field of Classification Search**

(57) **CLAIM**

USPC ..... D15/7-9; D21/584, 616

The ornamental design for an air pump, as shown and described.

CPC ..... F04B 53/14; F04B 53/92; F04B 33/00;

F04B 33/005; F04B 1/005; F04D 13/06;

F04D 29/22; F04D 29/046; F04D

29/2266; F16K 11/048; F16K 15/20;

F16K 31/602

**DESCRIPTION**

See application file for complete search history.

FIG. 1 is a perspective view of an air pump showing our new design;

FIG. 2 is a front view thereof;

FIG. 3 is a back view thereof;

FIG. 4 is a left view thereof;

FIG. 5 is a right view thereof;

FIG. 6 is a top view thereof; and,

FIG. 7 is a bottom view thereof.

The broken lines shown on the drawings depict portions of the air pump that form no part of the claimed design.

(56) **References Cited**

U.S. PATENT DOCUMENTS

D375,982 S \* 11/1996 Bhandhugravi ..... D21/616

D420,395 S \* 2/2000 Nielsen ..... D21/502

D499,114 S \* 11/2004 Poon ..... D15/7

D794,600 S \* 8/2017 Kwak ..... D14/203.2

D830,415 S \* 10/2018 Kennedy ..... D15/7

D908,170 S \* 1/2021 Li ..... D19/82

**1 Claim, 7 Drawing Sheets**

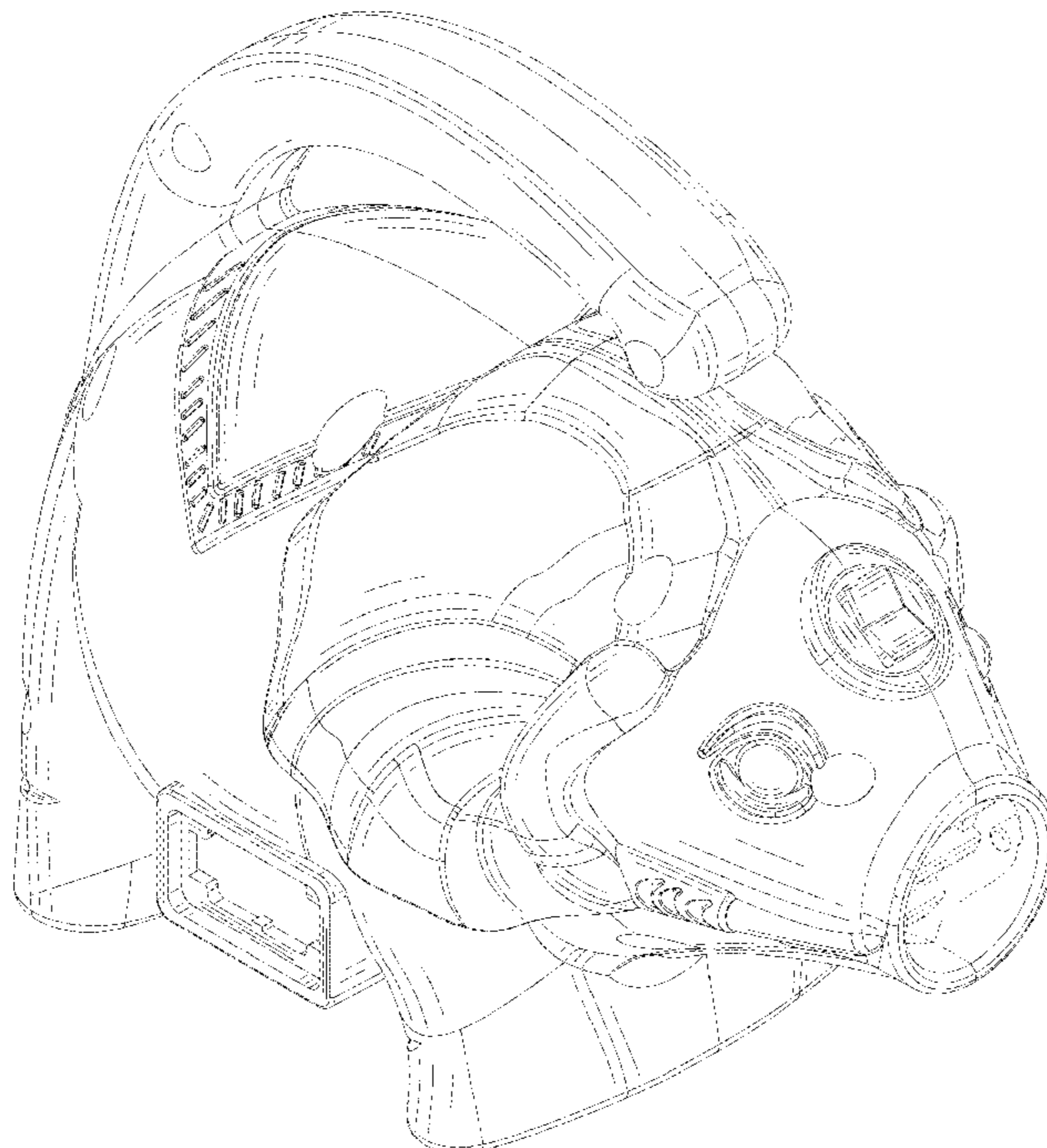

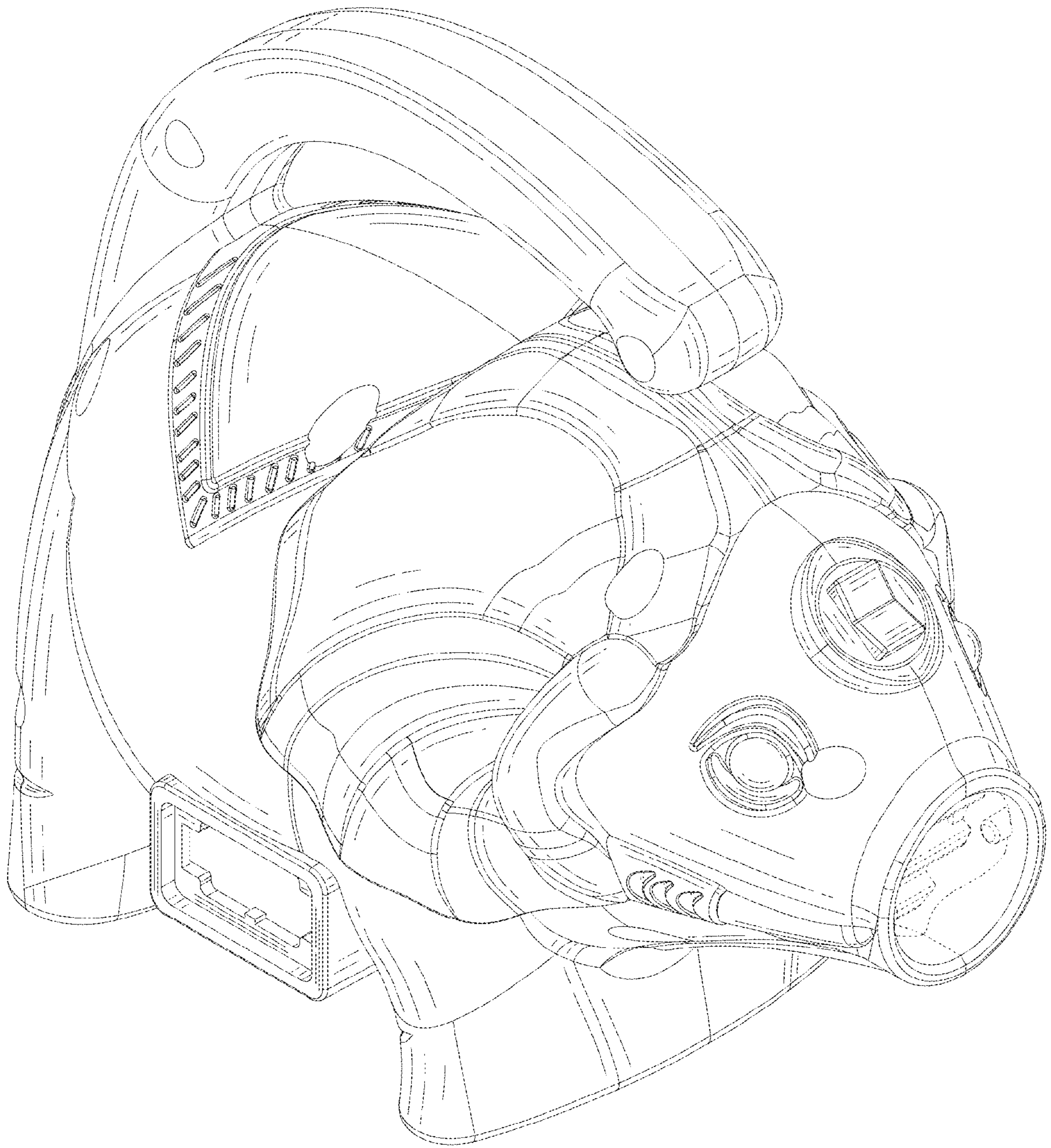

FIG. 1

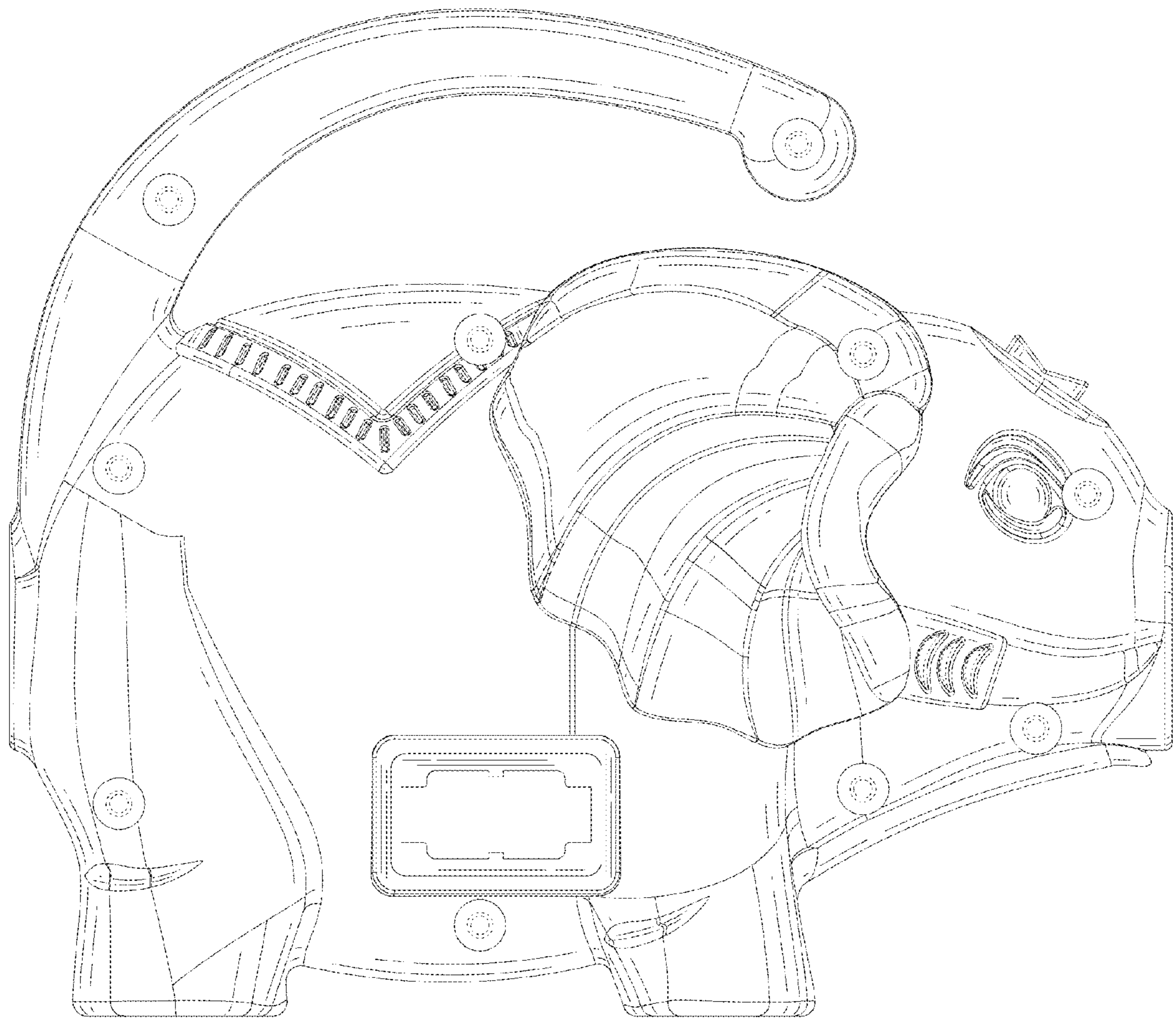

FIG. 2

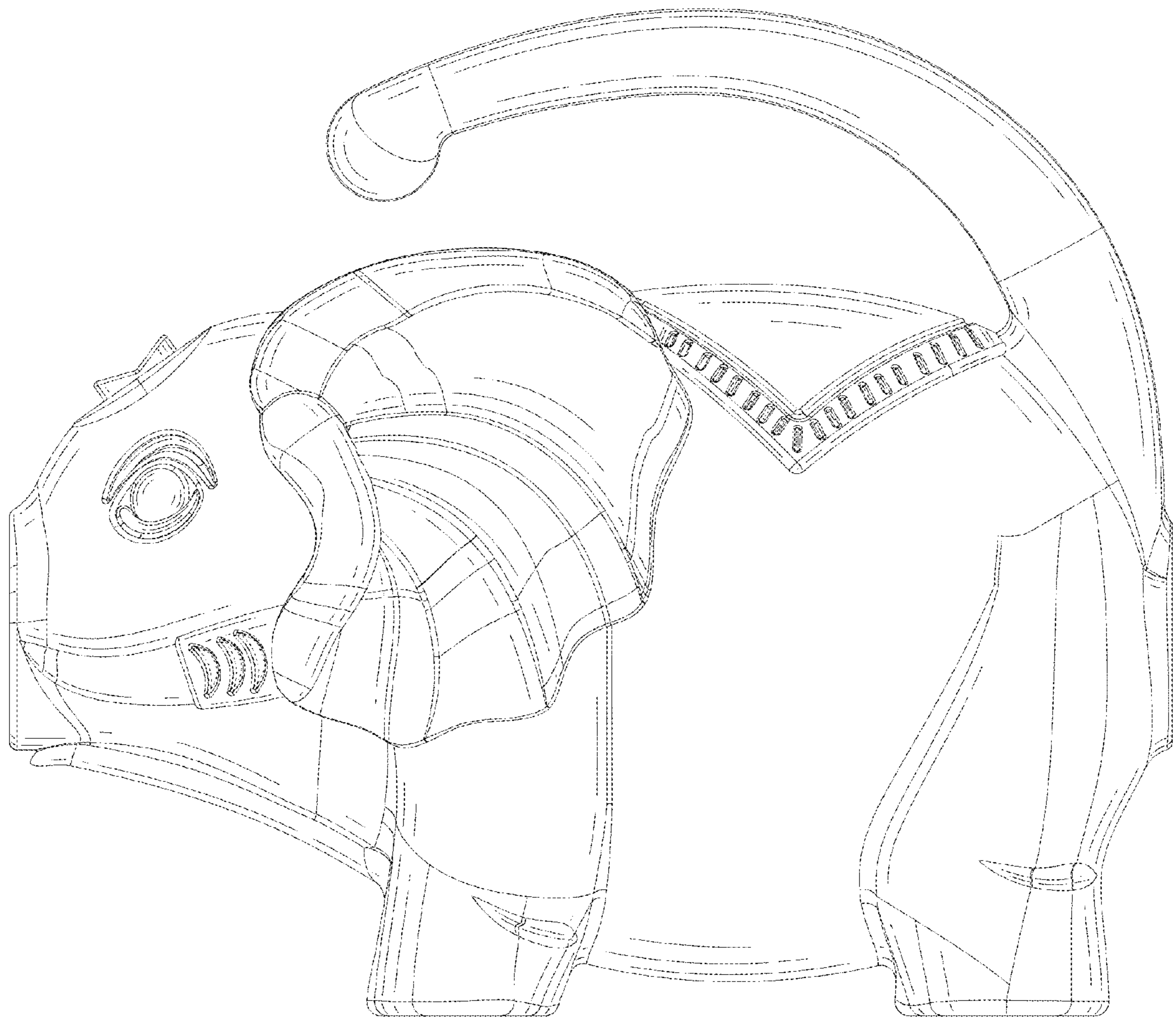

FIG. 3

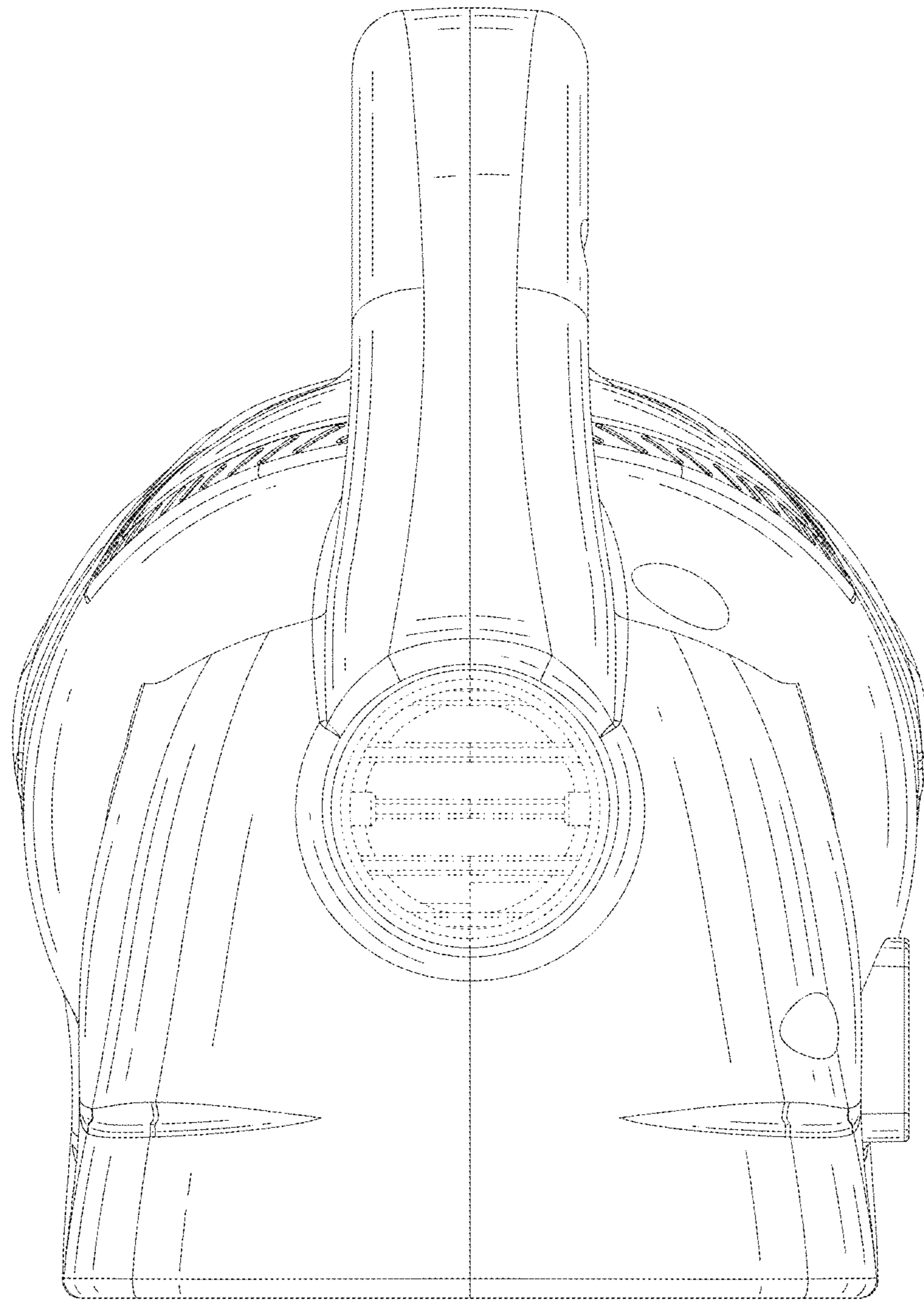

FIG. 4

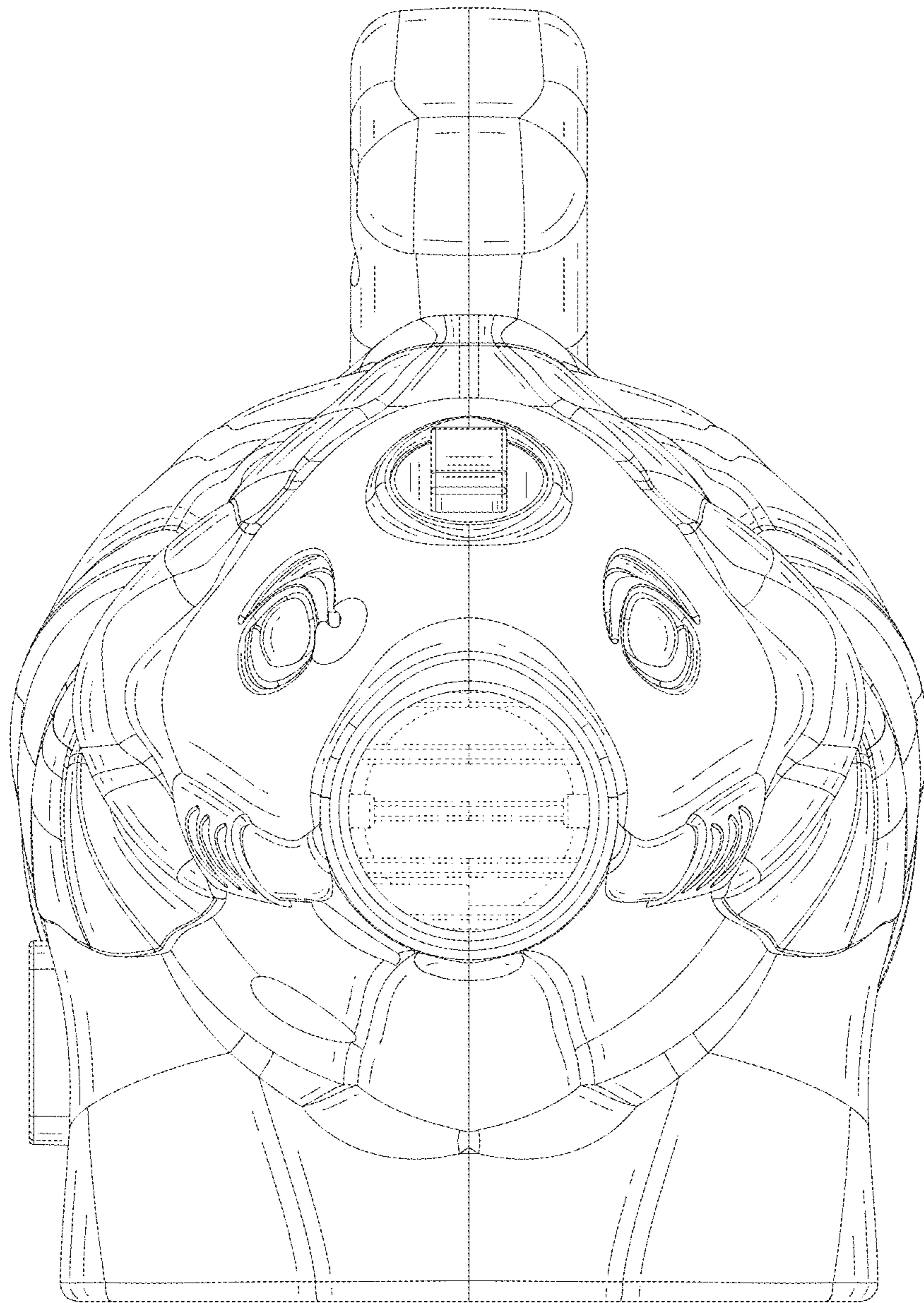

FIG. 5

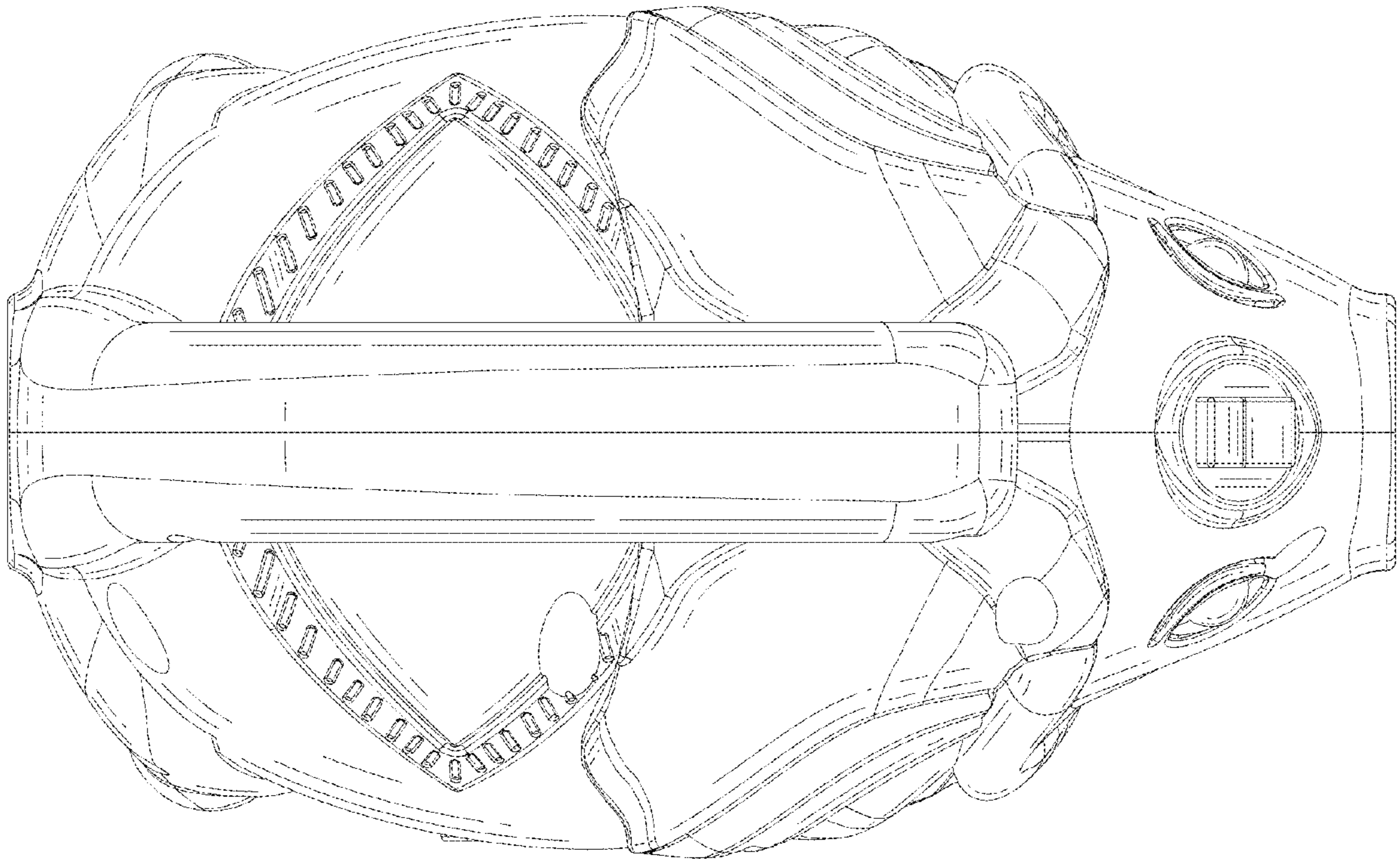

FIG. 6

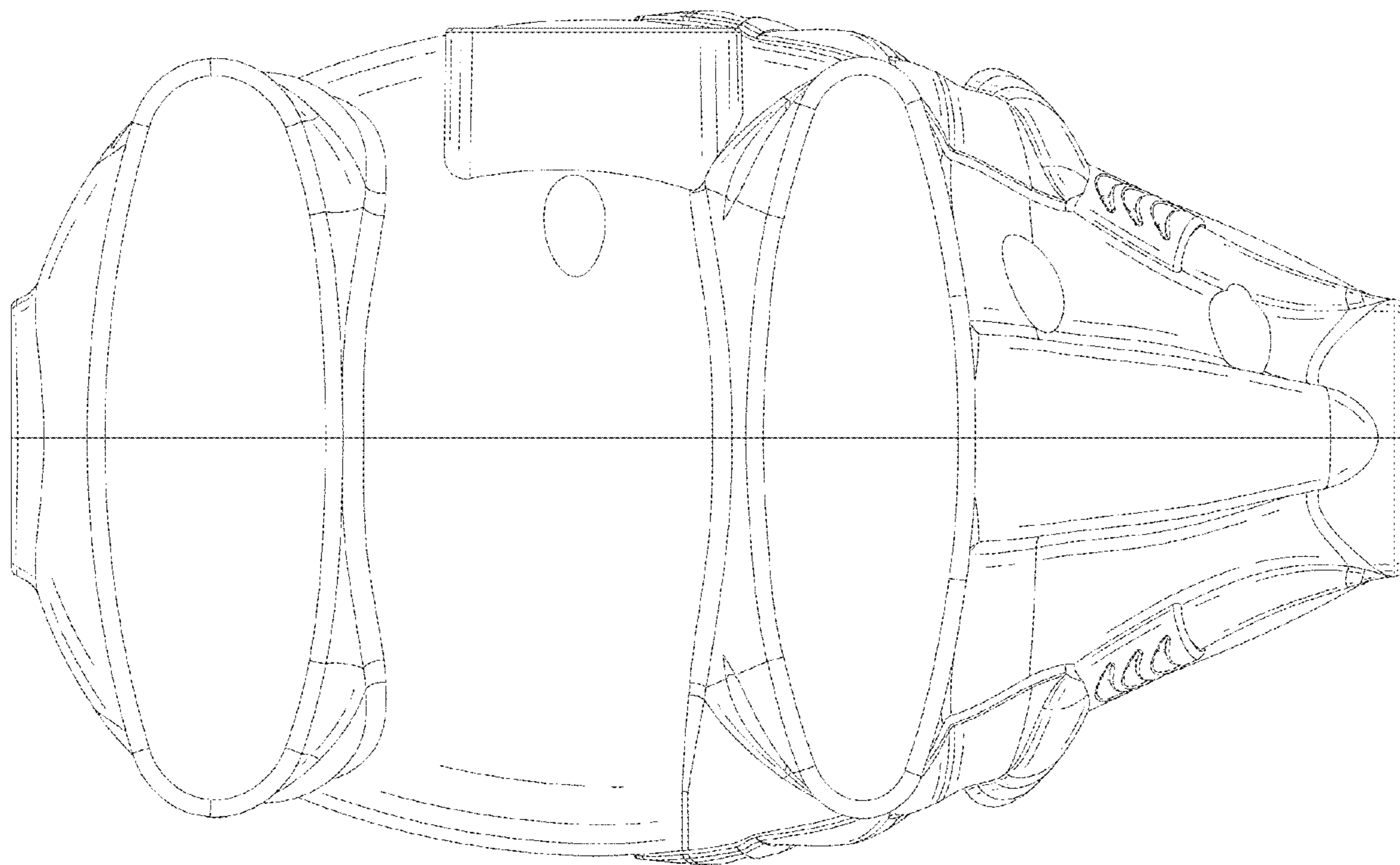

FIG. 7