



US00D971200S

(12) **United States Design Patent** (10) **Patent No.:** **US D971,200 S**
Lee (45) **Date of Patent:** **** Nov. 29, 2022**

(54) **COVER FOR ELECTRONIC COMMUNICATIONS DEVICE**
(71) Applicant: **ELAGO CO. LTD**, Goyang-si (KR)
(72) Inventor: **Chanwoo Lee**, Goyang-si (KR)
(73) Assignee: **elago CO. LTD**, Goyang-si (KR)
(**) Term: **15 Years**

(21) Appl. No.: **29/846,606**
(22) Filed: **Jul. 18, 2022**
(51) **LOC (13) Cl.** **14-03**
(52) **U.S. Cl.**
USPC **D14/250**
(58) **Field of Classification Search**
USPC D14/203.3–203.7, 439, 447, 251–253,
D14/217, 240, 238.1, 440, 248, 250;
D13/103, 107–108, 119; D3/201, 218,
D3/247, 249, 269, 273, 301, 303
CPC A45C 11/00; A45C 2011/002; A45C 1/06;
A45C 13/02; A45F 2200/0525; A45F
2005/026; A45F 2200/0516; H04M
1/0283; H04M 1/0202; H04B 1/3888
See application file for complete search history.

(56) **References Cited**
U.S. PATENT DOCUMENTS
D669,062 S * 10/2012 Rothbaum D14/250
D690,688 S * 10/2013 Bau D14/250
D718,291 S * 11/2014 Hong D14/250
D894,886 S 9/2020 Kim

FOREIGN PATENT DOCUMENTS
GB 6197686 3/2022
KR 301106112.0000 4/2021
(Continued)

Primary Examiner — Carla J Wright
(74) *Attorney, Agent, or Firm* — Paratus Law Group, PLLC

(57) **CLAIM**
The ornamental design for a cover for electronic communications device, as shown and described.

DESCRIPTION
FIG. 1 is a front, top, and right side perspective view of a cover for electronic communications device, showing a first embodiment of my new design;
FIG. 2 is a front view of the first embodiment;
FIG. 3 is a back view of the first embodiment;
FIG. 4 is a left side view of the first embodiment;
FIG. 5 is a right side view of the first embodiment;
FIG. 6 is a top view of the first embodiment;
FIG. 7 is a bottom view of the first embodiment;
FIG. 8 is a front, top, and left side perspective view of the first embodiment;
FIG. 9 is a back, top, and left side perspective view of the first embodiment;
FIG. 10 is a back, bottom, and right side perspective view of the first embodiment;
FIG. 11 is a front, top, and right side perspective view of a cover for electronic communications device, showing a second embodiment of my new design;
FIG. 12 is a front view of the second embodiment;
FIG. 13 is a back view of the second embodiment;
FIG. 14 is a left side view of the second embodiment;
FIG. 15 is a right side view of the second embodiment;
FIG. 16 is a top view of the second embodiment;
FIG. 17 is a bottom view of the second embodiment;
FIG. 18 is a front, top, and left side perspective view of the second embodiment;
FIG. 19 is a back, top, and left side perspective view of the second embodiment; and,
FIG. 20 is a back, bottom, and right side perspective view of the second embodiment.

1 Claim, 16 Drawing Sheets

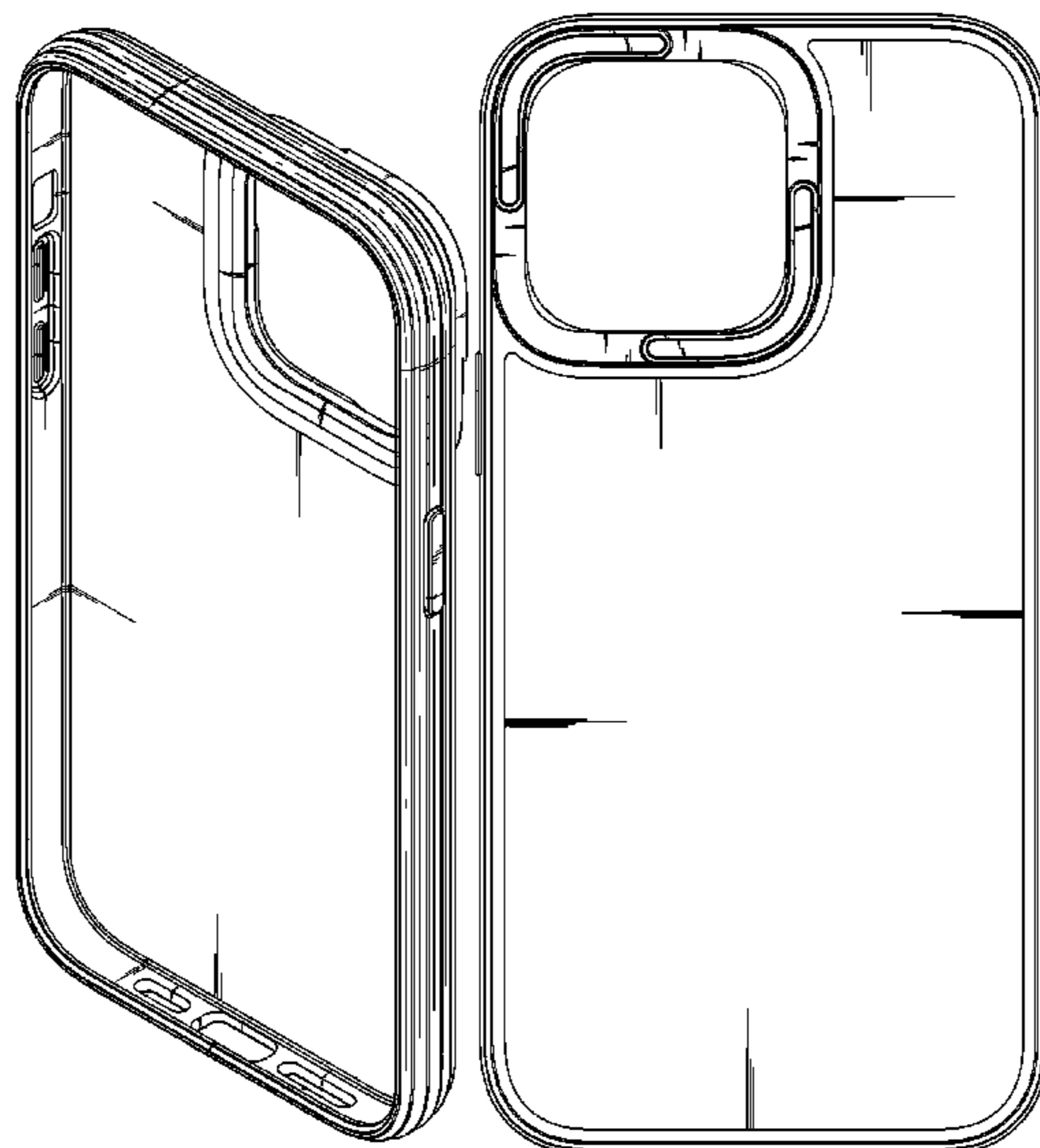

(56)

References Cited

U.S. PATENT DOCUMENTS

D896,212 S * 9/2020 Wang D14/250
D898,015 S * 10/2020 Kwak D14/250
D899,414 S * 10/2020 Koo D14/250
D899,415 S * 10/2020 Kwak D14/250
D899,416 S 10/2020 Kwak et al.
D901,479 S 11/2020 Altschul et al.
D902,193 S 11/2020 Altschul et al.
D902,913 S 11/2020 Lee
D903,647 S * 12/2020 Lin D14/250
D904,383 S 12/2020 Kim
D905,676 S 12/2020 Kim
D905,680 S * 12/2020 Kim D14/250
D908,118 S * 1/2021 Lu D3/249
D908,680 S 1/2021 Kim
D909,359 S * 2/2021 Kim D14/250
D917,445 S * 4/2021 Li D14/250
D918,888 S 5/2021 Feng

D934,850 S 11/2021 Weng
D940,122 S * 1/2022 Chong D14/250
D940,698 S 1/2022 Qu
D947,165 S * 3/2022 Wu D14/250
D949,139 S 4/2022 Chen
D959,417 S * 8/2022 Feng D14/250
D961,575 S * 8/2022 Liu D14/250
2013/0257240 A1 * 10/2013 Hong H04B 1/3888
312/223.1
2014/0221056 A1 * 8/2014 Gandhi H04B 1/3888
455/575.8
2021/0159933 A1 * 5/2021 Dufelmeier H04B 1/3888
2022/0224370 A1 * 7/2022 Elitas A45C 13/36

FOREIGN PATENT DOCUMENTS

KR 301165870.0000 5/2022
WO WO D220417-001 6/2022

* cited by examiner

FIG. 1

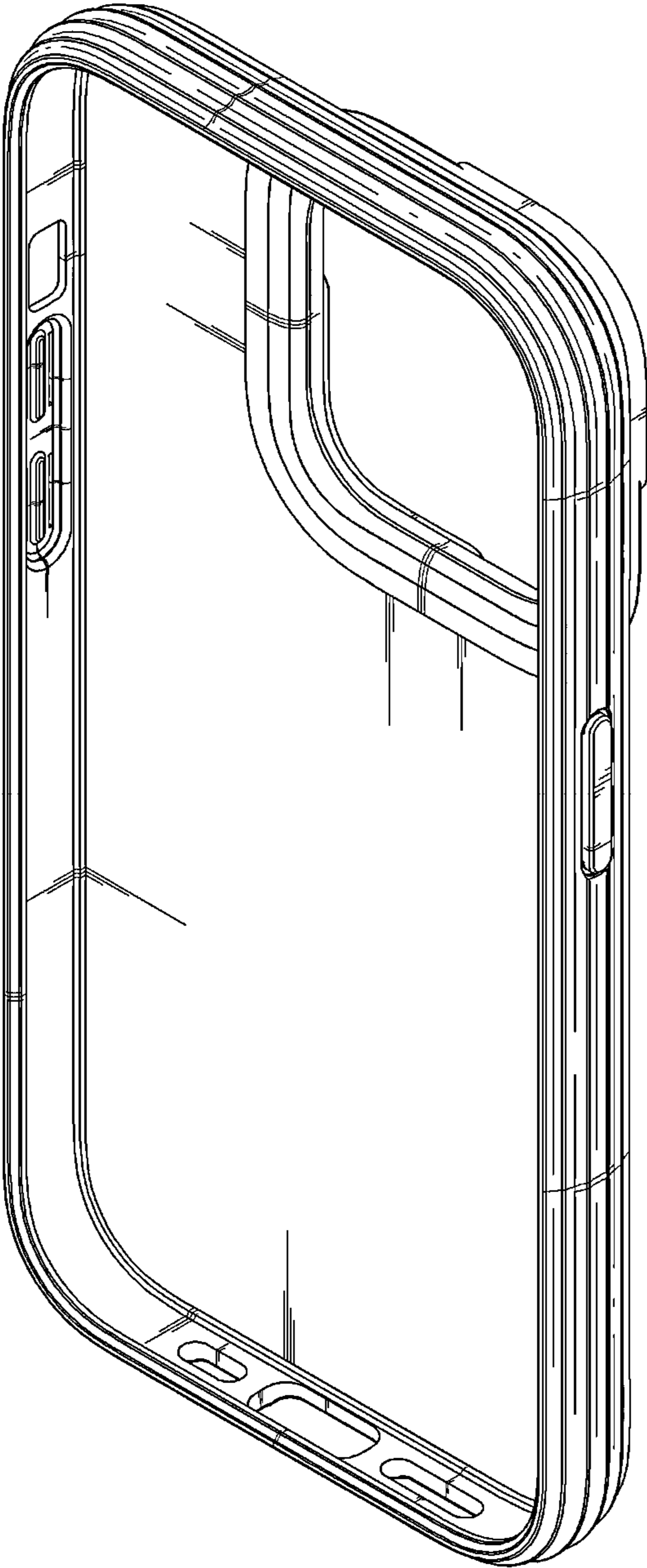

FIG. 2

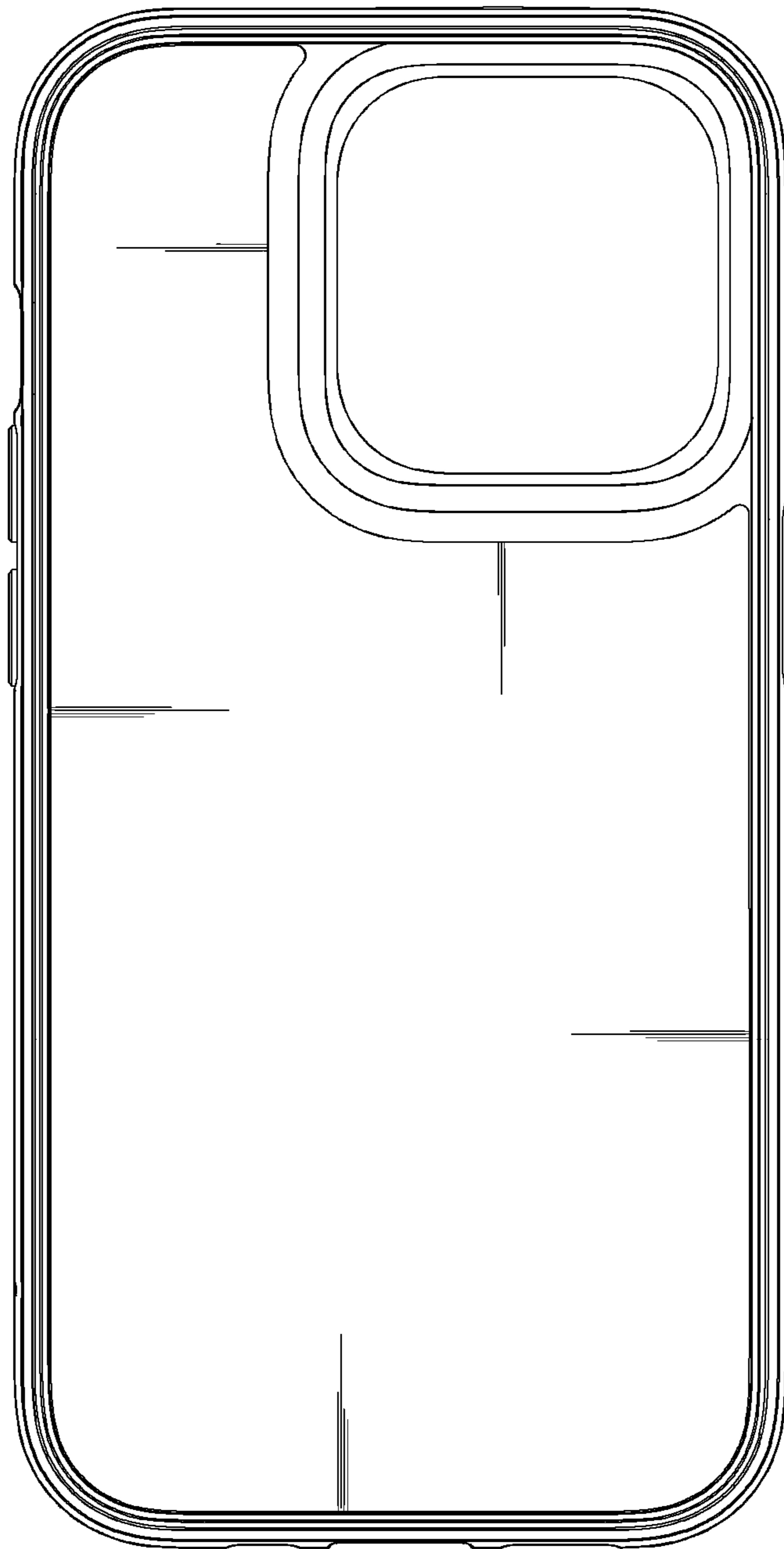

FIG. 3

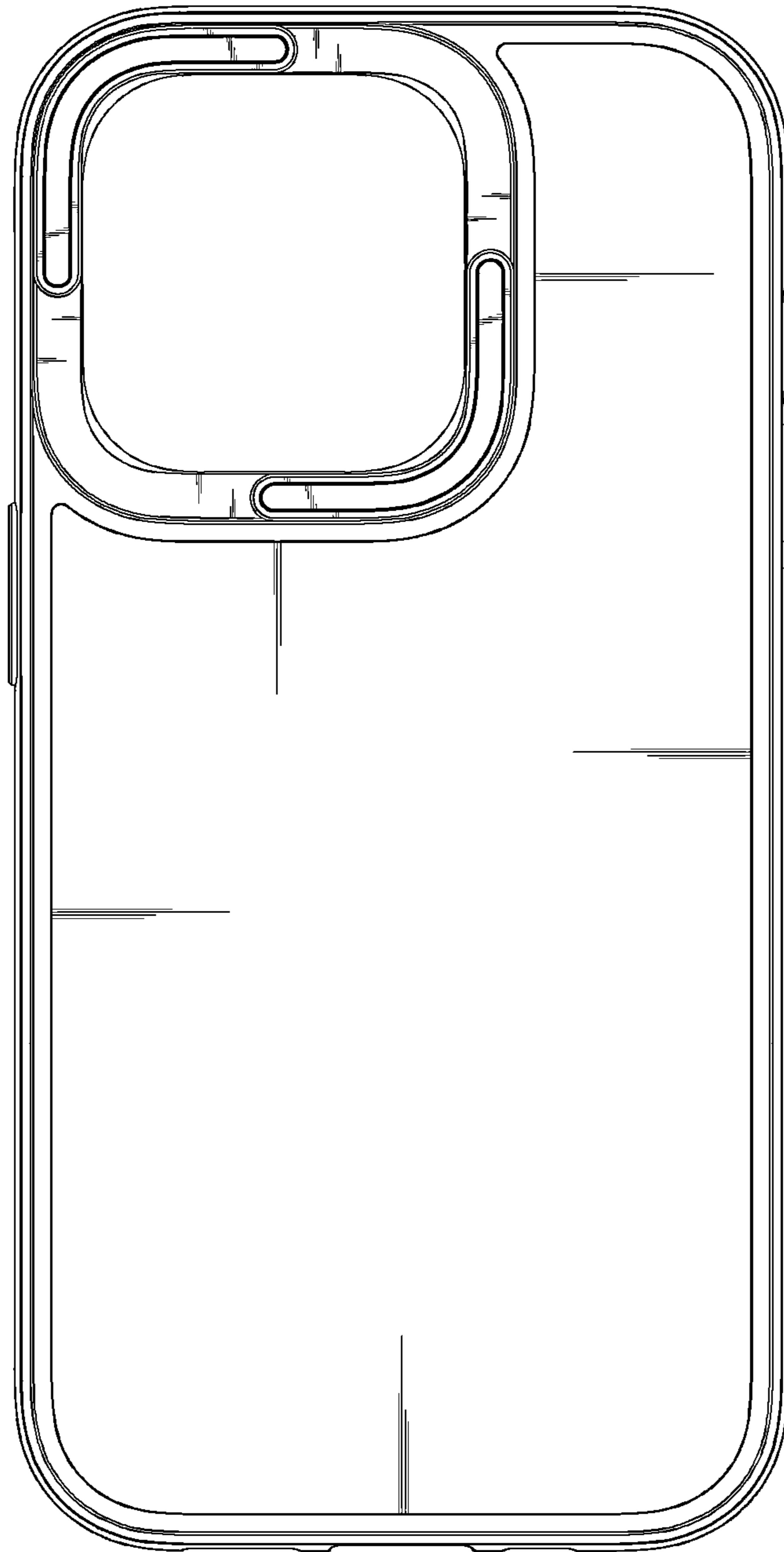

FIG. 4

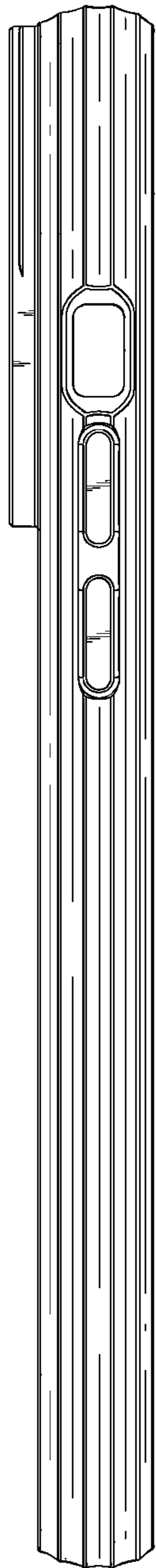

FIG. 5

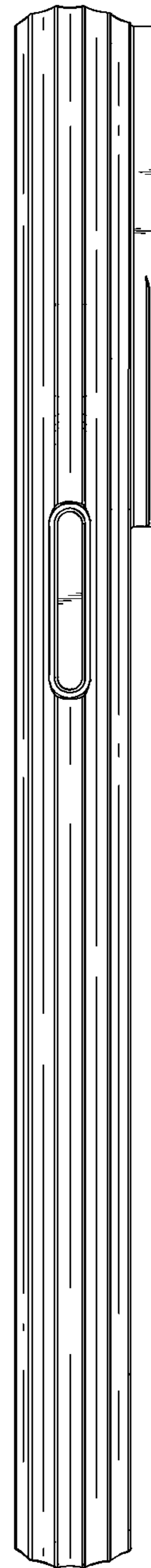

FIG. 6

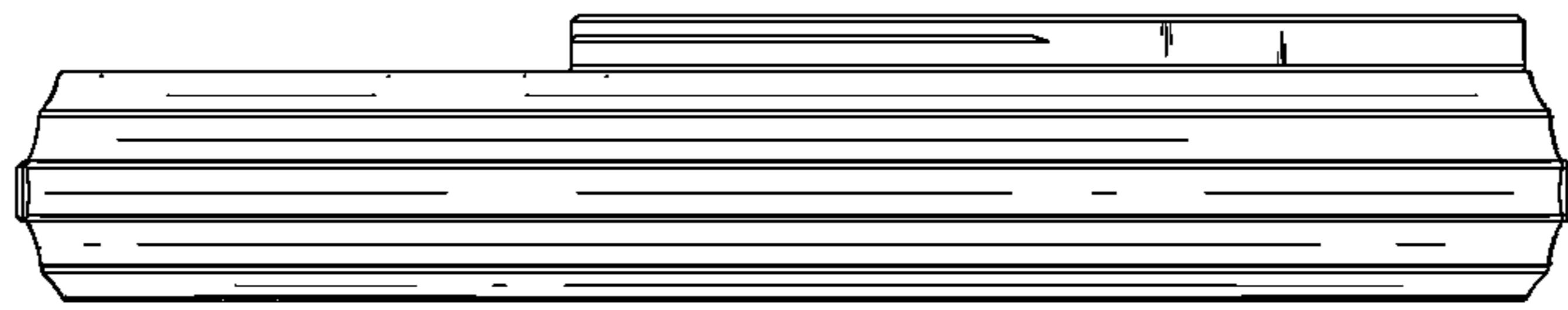

FIG. 7

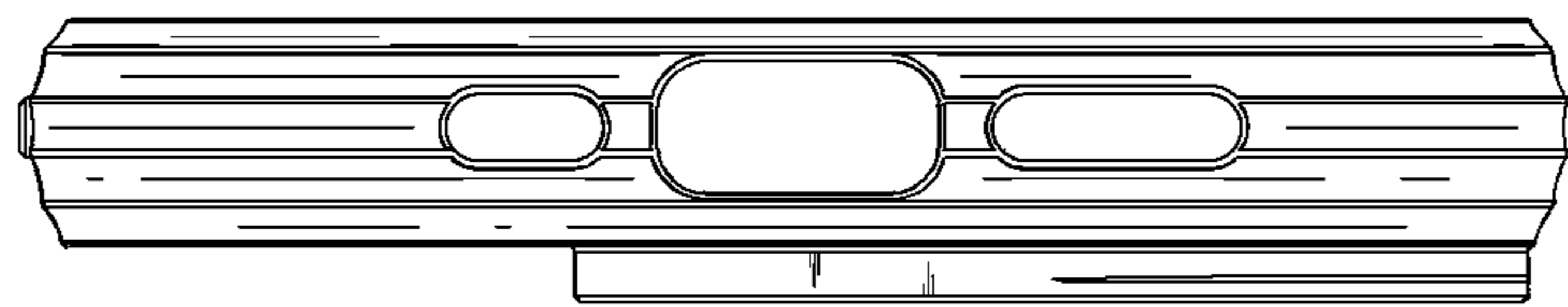

FIG. 8

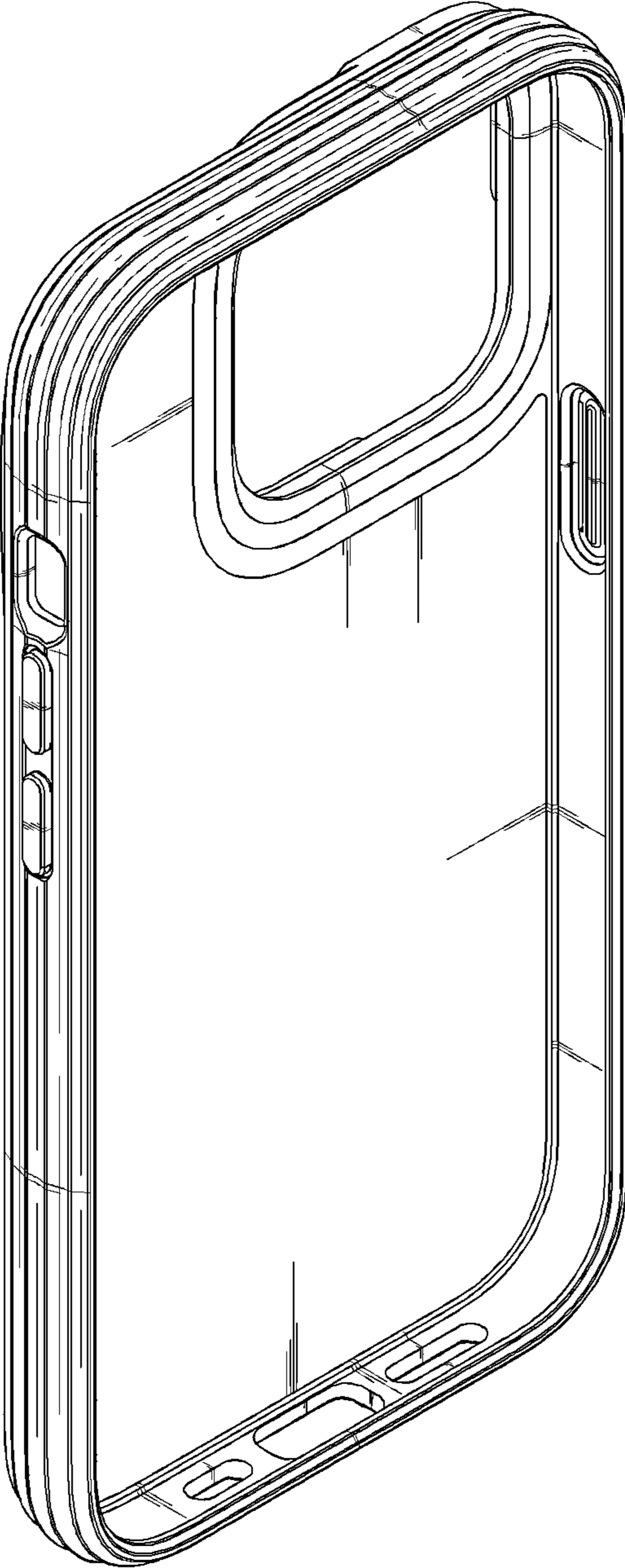

FIG. 9

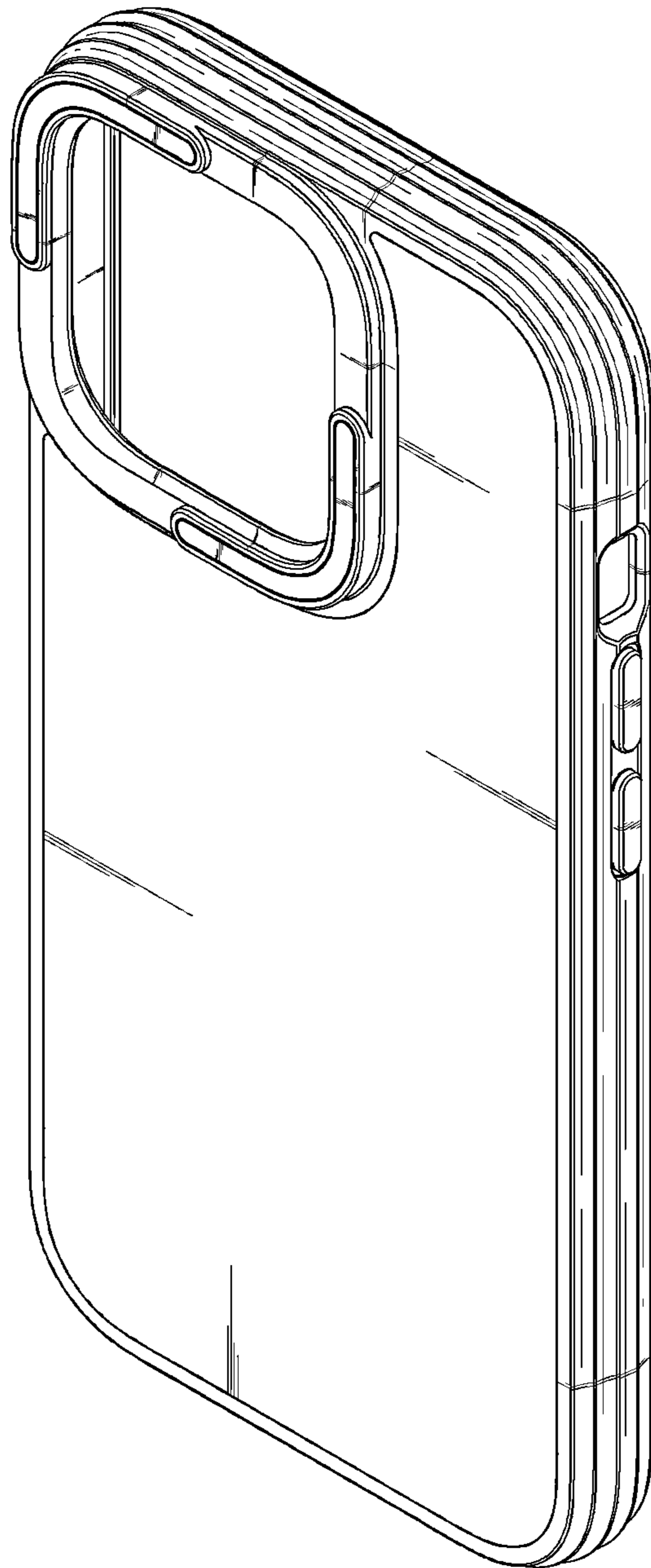

FIG. 10

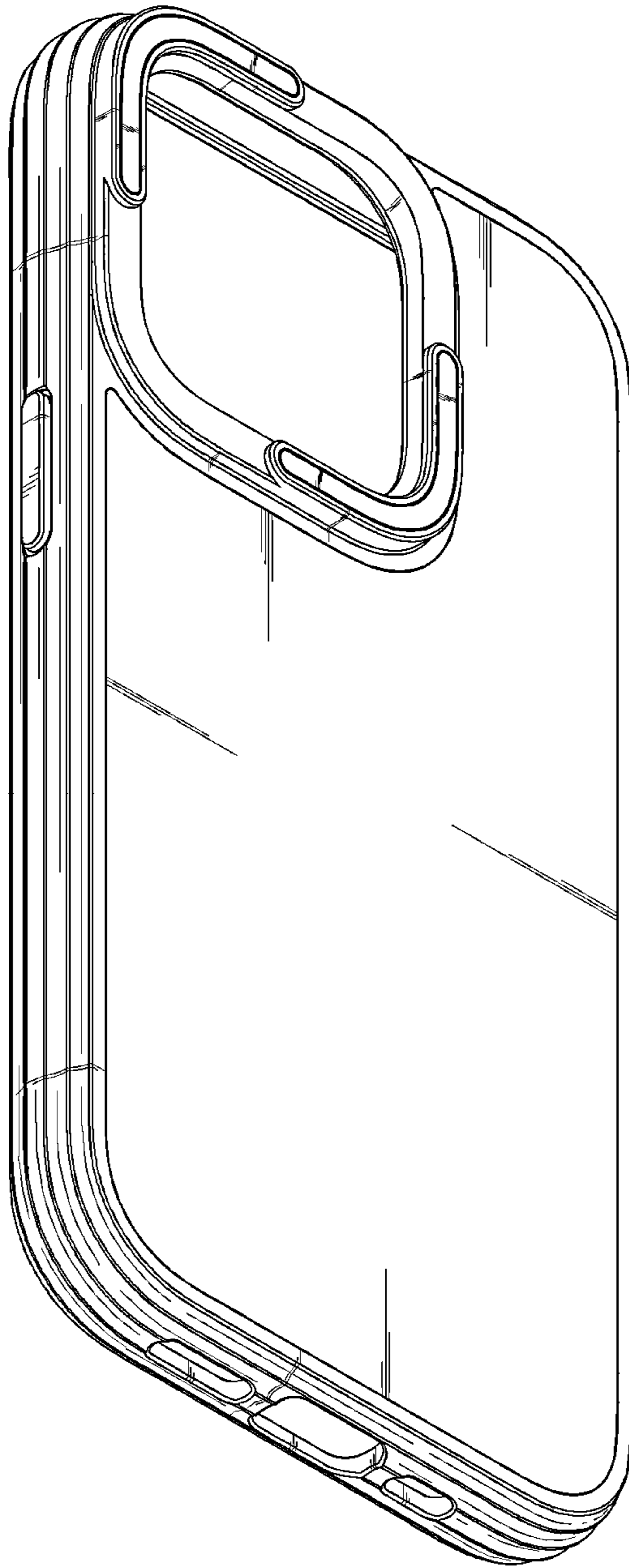

FIG. 11

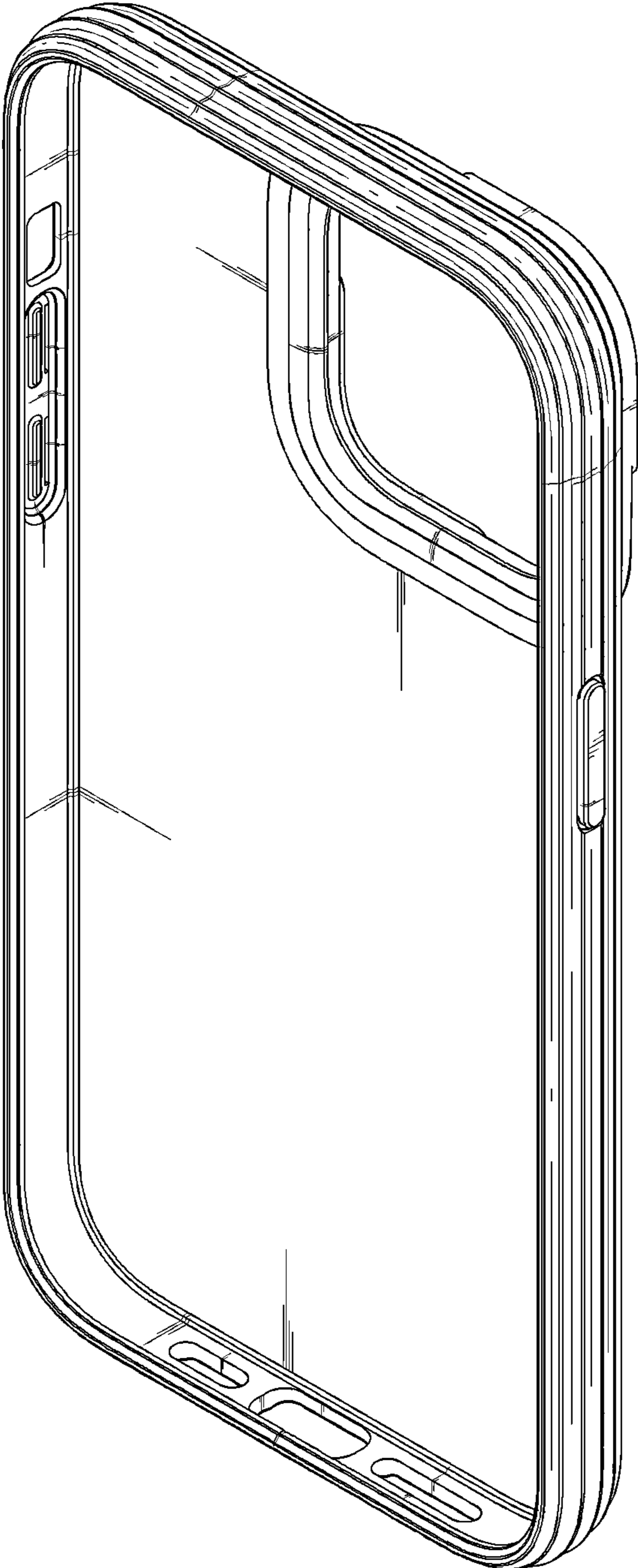

FIG. 12

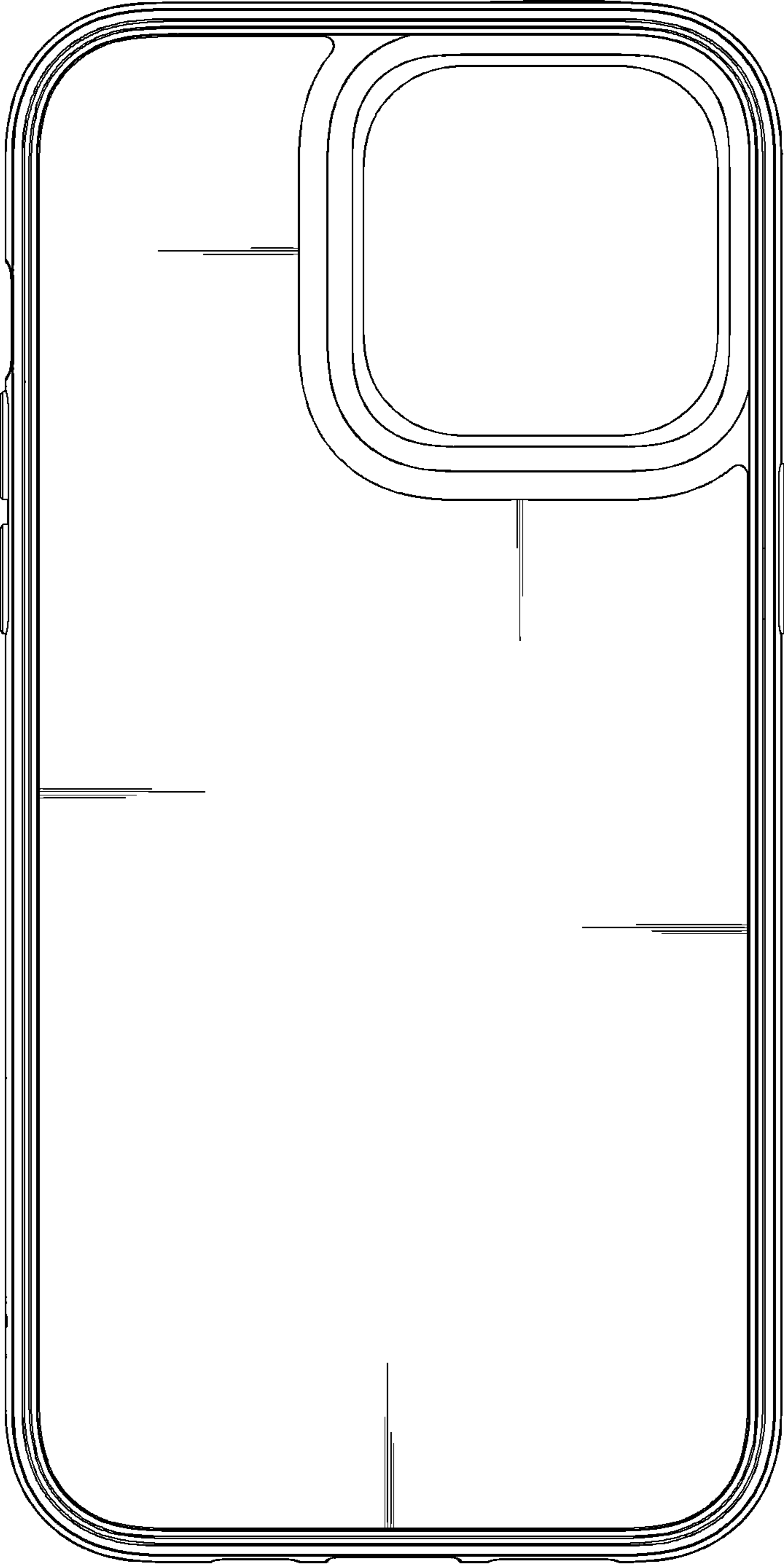

FIG. 13

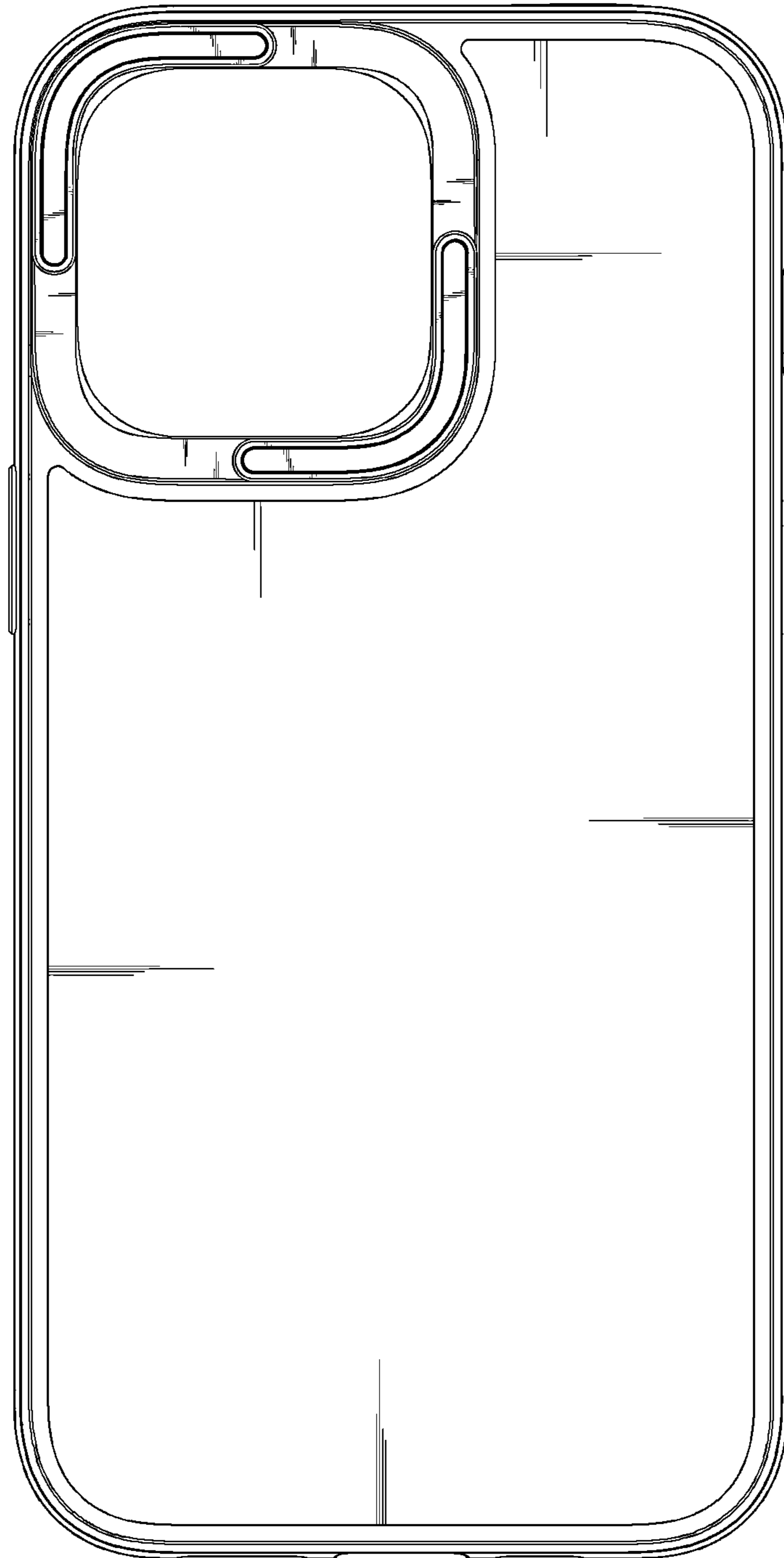

FIG. 14

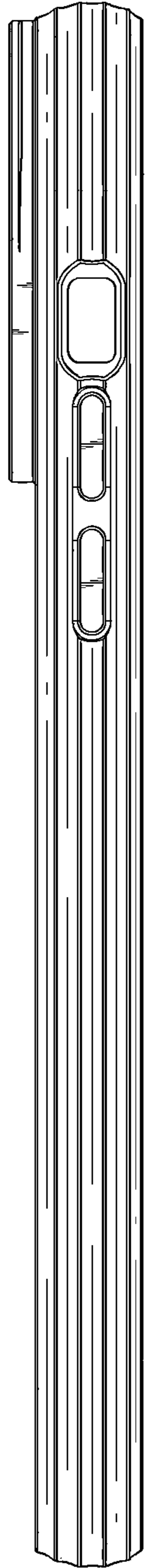

FIG. 15

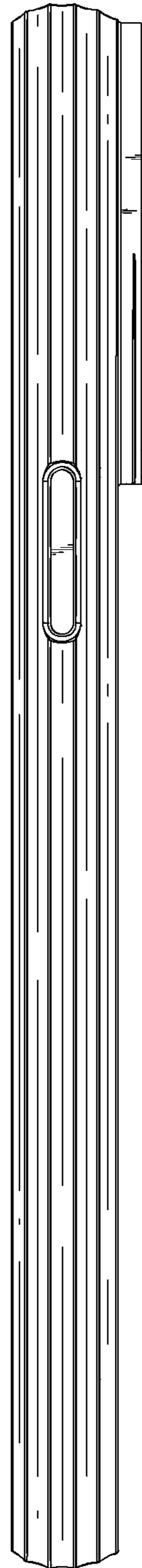

FIG. 16

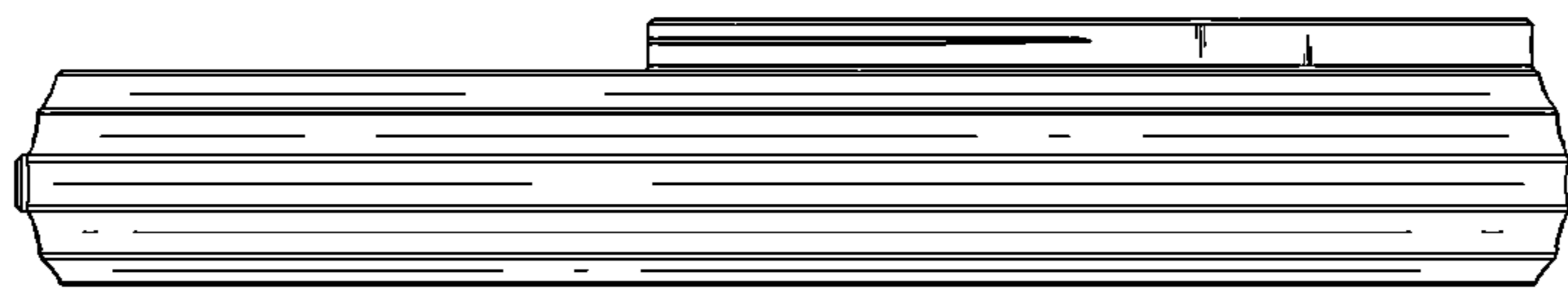

FIG. 17

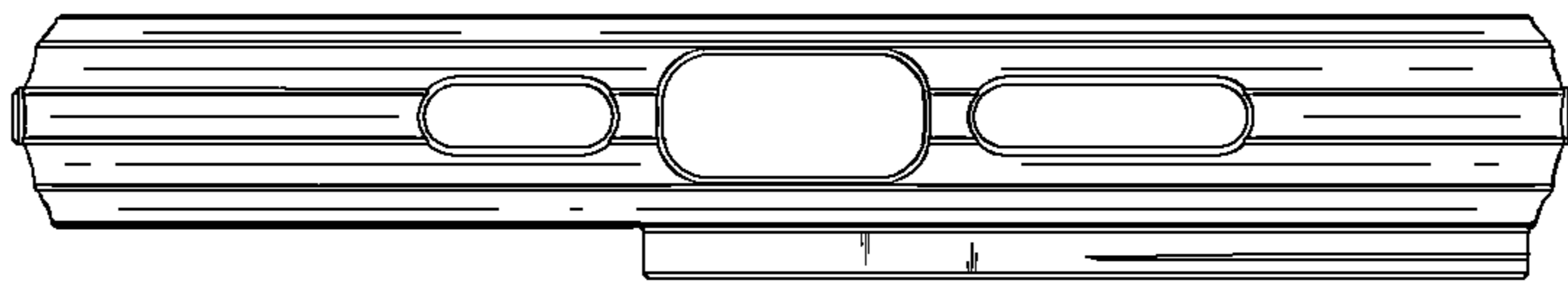

FIG. 18

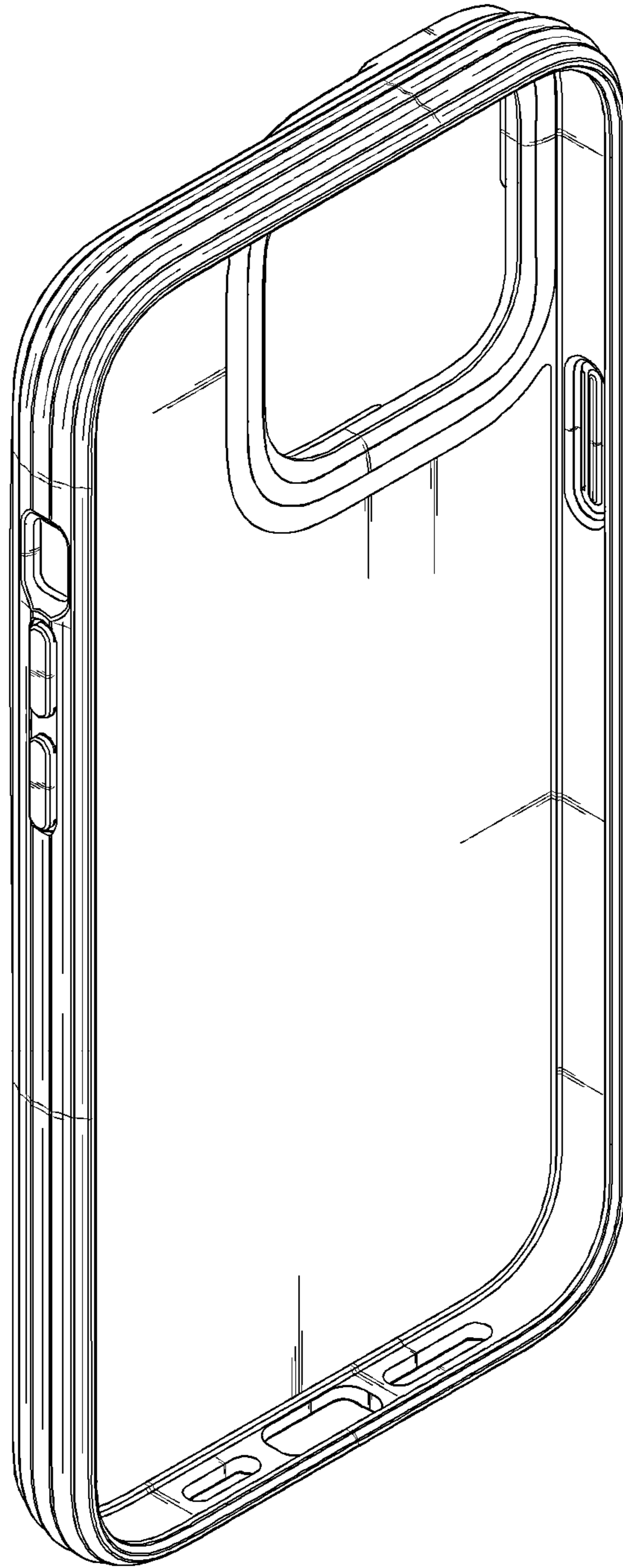

FIG. 19

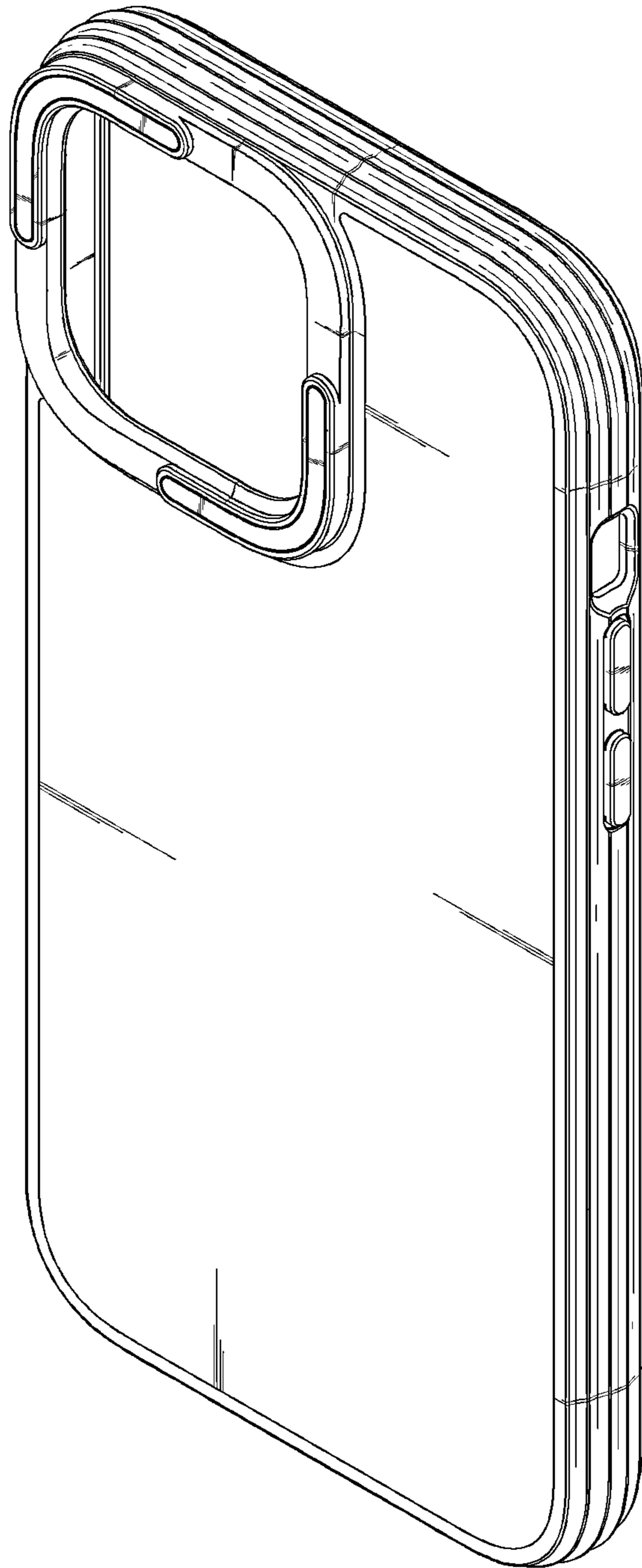

FIG. 20

