



US00D971182S

(12) **United States Design Patent**  
**Jang et al.**

(10) **Patent No.:** **US D971,182 S**

(45) **Date of Patent:** **\*\* Nov. 29, 2022**

(54) **EARPHONE**

(71) Applicant: **Samsung Electronics Co., Ltd.**,  
Suwon-si (KR)

(72) Inventors: **Youngsang Jang**, Suwon-si (KR);  
**Yongseok Bang**, Suwon-si (KR)

(73) Assignee: **Samsung Electronics Co., Ltd.**,  
Suwon-si (KR)

(\*\*) Term: **15 Years**

(21) Appl. No.: **29/751,692**

(22) Filed: **Sep. 23, 2020**

(30) **Foreign Application Priority Data**

May 15, 2020 (KR) ..... 30-2020-0021339

(51) **LOC (13) Cl.** ..... **14-01**

(52) **U.S. Cl.**  
USPC ..... **D14/223**

(58) **Field of Classification Search**  
USPC ..... D14/205, 207, 217, 221, 225, 223;  
D24/106, 173, 174; D29/112  
CPC ..... H04R 1/10; H04R 1/1016; H04R 1/1066;  
H04R 1/105; H04R 1/1033; H04R 1/08;  
H04R 5/033; H04R 5/0335; H04R 25/00  
See application file for complete search history.

(56) **References Cited**

**U.S. PATENT DOCUMENTS**

D806,879 S \* 1/2018 Horbinski ..... D24/174  
D812,042 S \* 3/2018 Xiao ..... D14/223  
D883,258 S \* 5/2020 Wu ..... D14/223

(Continued)

**FOREIGN PATENT DOCUMENTS**

CN 201630462537 3/2017  
CN 2017306748947 7/2018

(Continued)

**OTHER PUBLICATIONS**

Urbanx Street Buds, first available Jul. 5, 2021 [online], [retrieved Apr. 7, 2022]. Available from the Internet, URL:<[https://www.amazon.com/dp/B098PGKVH1/ref=cm\\_sw\\_em\\_r\\_mt\\_dp\\_W72M3RH8PSNB8A8N13T7?\\_encoding=UTF8&psc=1](https://www.amazon.com/dp/B098PGKVH1/ref=cm_sw_em_r_mt_dp_W72M3RH8PSNB8A8N13T7?_encoding=UTF8&psc=1)>. (Year: 2021).\*

(Continued)

*Primary Examiner* — Dana K Weiland  
*Assistant Examiner* — Russell Carnell Smith, Jr.

(74) *Attorney, Agent, or Firm* — NSIP Law

(57) **CLAIM**

We claim the ornamental design for an earphone, as shown and described.

**DESCRIPTION**

FIG. 1 is a front perspective view of an earphone showing our new design according to a first embodiment; FIG. 2 is a front view thereof; FIG. 3 is a rear view thereof; FIG. 4 is a left-side view thereof; FIG. 5 is a right-side view thereof; FIG. 6 is a top view thereof; FIG. 7 is a bottom view thereof; FIG. 8 is a rear perspective view thereof; FIG. 9 is a front perspective view of an earphone showing our new design according to a second embodiment; FIG. 10 is a front view thereof; FIG. 11 is a rear view thereof; FIG. 12 is a left-side view thereof; FIG. 13 is a right-side view thereof; FIG. 14 is a top view thereof; FIG. 15 is a bottom view thereof; and, FIG. 16 is a rear perspective view thereof. The broken lines in the figures depict portions of the earphone which form no part of the claimed design.

**1 Claim, 16 Drawing Sheets**

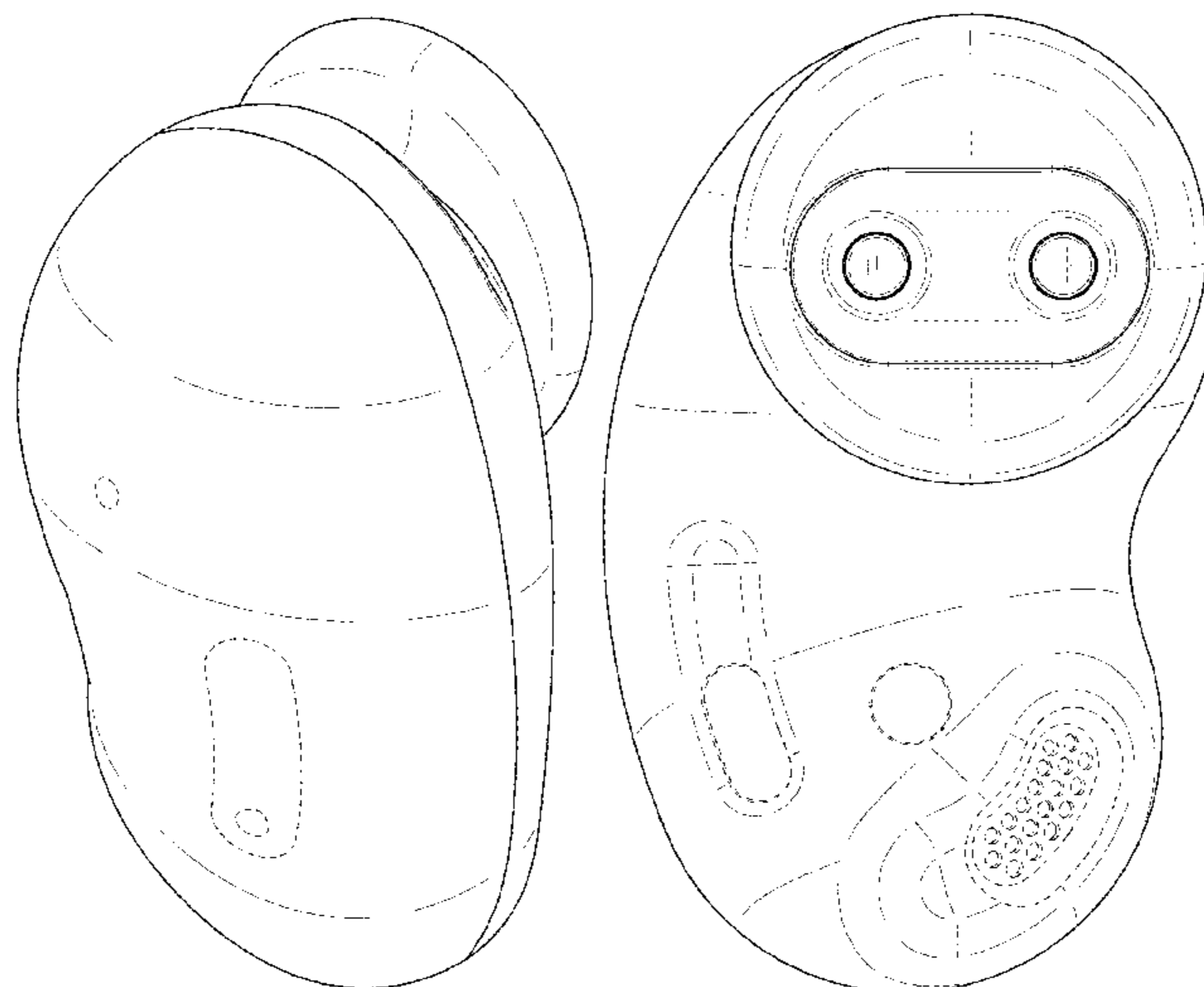

(56)

**References Cited**

U.S. PATENT DOCUMENTS

D897,319	S	*	9/2020	Wang	.....	D14/223
D902,186	S	*	11/2020	Sun	.....	D14/223
D908,667	S	*	1/2021	He	.....	D14/223
D912,648	S	*	3/2021	Williamson	.....	D14/223
D917,428	S	*	4/2021	Khoi	.....	D14/223
D926,163	S	*	7/2021	Williamson	.....	D14/223
D961,556	S	*	8/2022	Hong	.....	D14/223
D962,201	S	*	8/2022	Jang	.....	D14/223

FOREIGN PATENT DOCUMENTS

CN	306531502	*	5/2021
CN	306570039	*	5/2021
EM	005508231-0001		8/2018
EM	003870401-0001		9/2018
EM	003870401-0002		9/2018
JP	D1382302		3/2010

OTHER PUBLICATIONS

Esquire, first available Nov. 26, 2020 [online], [retrieved Sep. 14, 2022]. Available from the Internet, URL:<<https://www.esquire.com/>

[lifestyle/a34789661/samsung-galaxy-buds-live-wireless-earbuds-endorsement-review/](https://lifestyle/a34789661/samsung-galaxy-buds-live-wireless-earbuds-endorsement-review/)>. (Year: 2020).\*

TWS Bluetooth 5.1, first available Mar. 8, 2021 [online], [retrieved Sep. 14, 2022]. Available from the Internet, URL:<<https://a.co/d/5FVgDI5>>. (Year: 2021).\*

Samsung Galaxy Buds Live, first available Mar. 3, 2022 [online], [retrieved Sep. 14, 2022]. Available from the Internet, URL:<<https://a.co/d/8Iny1OX>>. (Year: 2022).\*

Sony. “Music with nothing to hold you back” [2020] [www.sony.co.nz](http://www.sony.co.nz) Sep. 23, 2020 <<https://www.sony.co.nz/electronics/truly-wireless/wf-sp700n>>.

Robotsky. “Mini S650X Wireless Bluetooth Earphone Stereo In Ear Headset Earbuds with Mic best earphone 2019” [2019] [www.shopee.sg](http://www.shopee.sg) Sep. 2019 <<https://shopee.sg/Mini-S650X-Wireless-Bluetooth-Earphone-Stereo-In-Ear-Headset-Earbuds-with-Mic-best-earphone-2019-i.133140769.2756984559>>.

“Brio SkyBorn S4 True Wireless Earbuds” [2019] [www.store.nypost.com](http://www.store.nypost.com) Mar. 18, 2019 <[https://store.nypost.com/sales/brio-true-wireless-earbuds-gun-metal?utm\\_source=nypost.com&utm\\_medium=referral&utm\\_campaign=brio-true-wireless-earbuds-gun-metal&utm\\_term=scsf-360808&utm\\_content=a0x1P00004MyMz&scsonar=1&\\_ga=2.28720636.117089671.1600650542-591973103.1600650542](https://store.nypost.com/sales/brio-true-wireless-earbuds-gun-metal?utm_source=nypost.com&utm_medium=referral&utm_campaign=brio-true-wireless-earbuds-gun-metal&utm_term=scsf-360808&utm_content=a0x1P00004MyMz&scsonar=1&_ga=2.28720636.117089671.1600650542-591973103.1600650542)>.

\* cited by examiner

FIG. 1

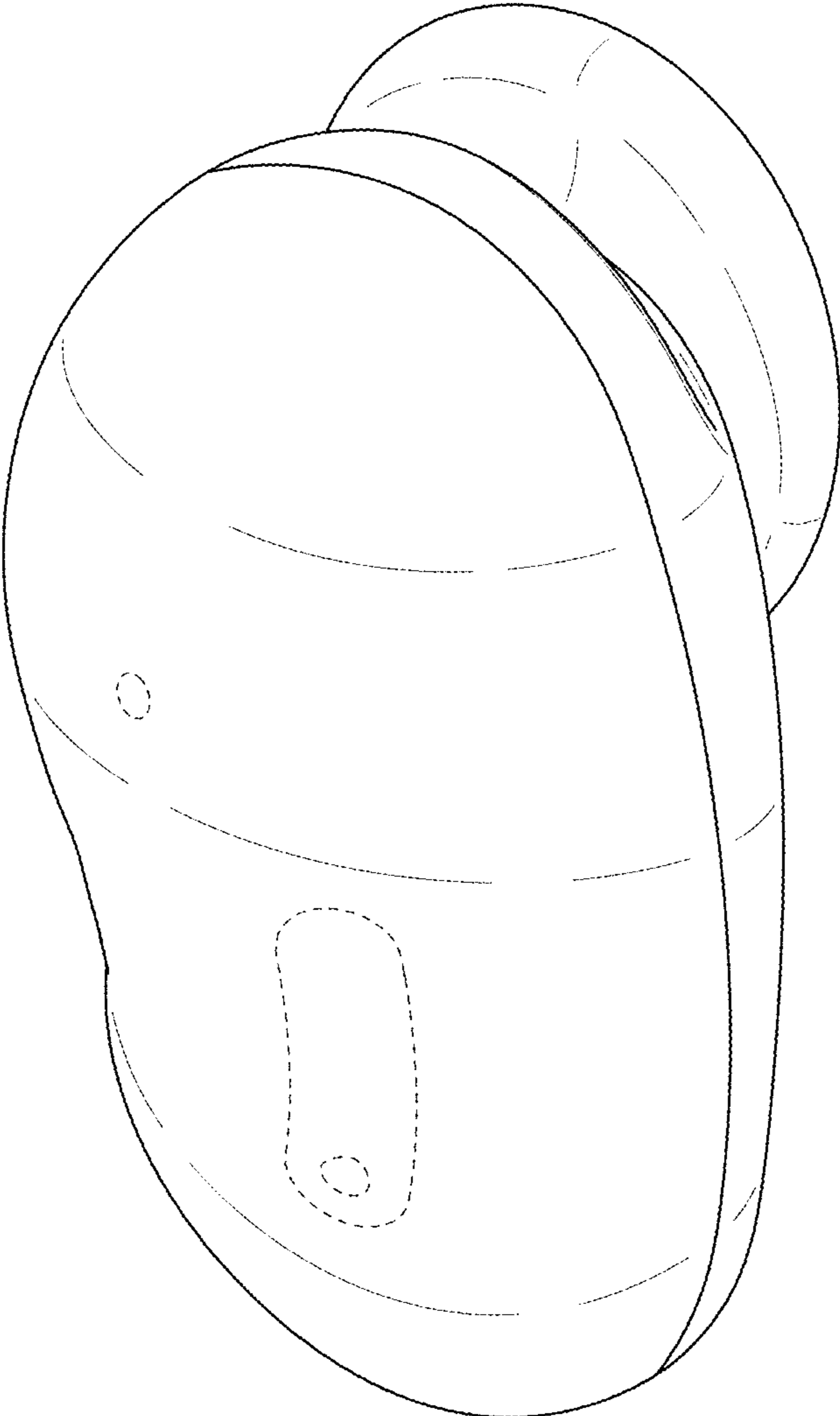

FIG. 2

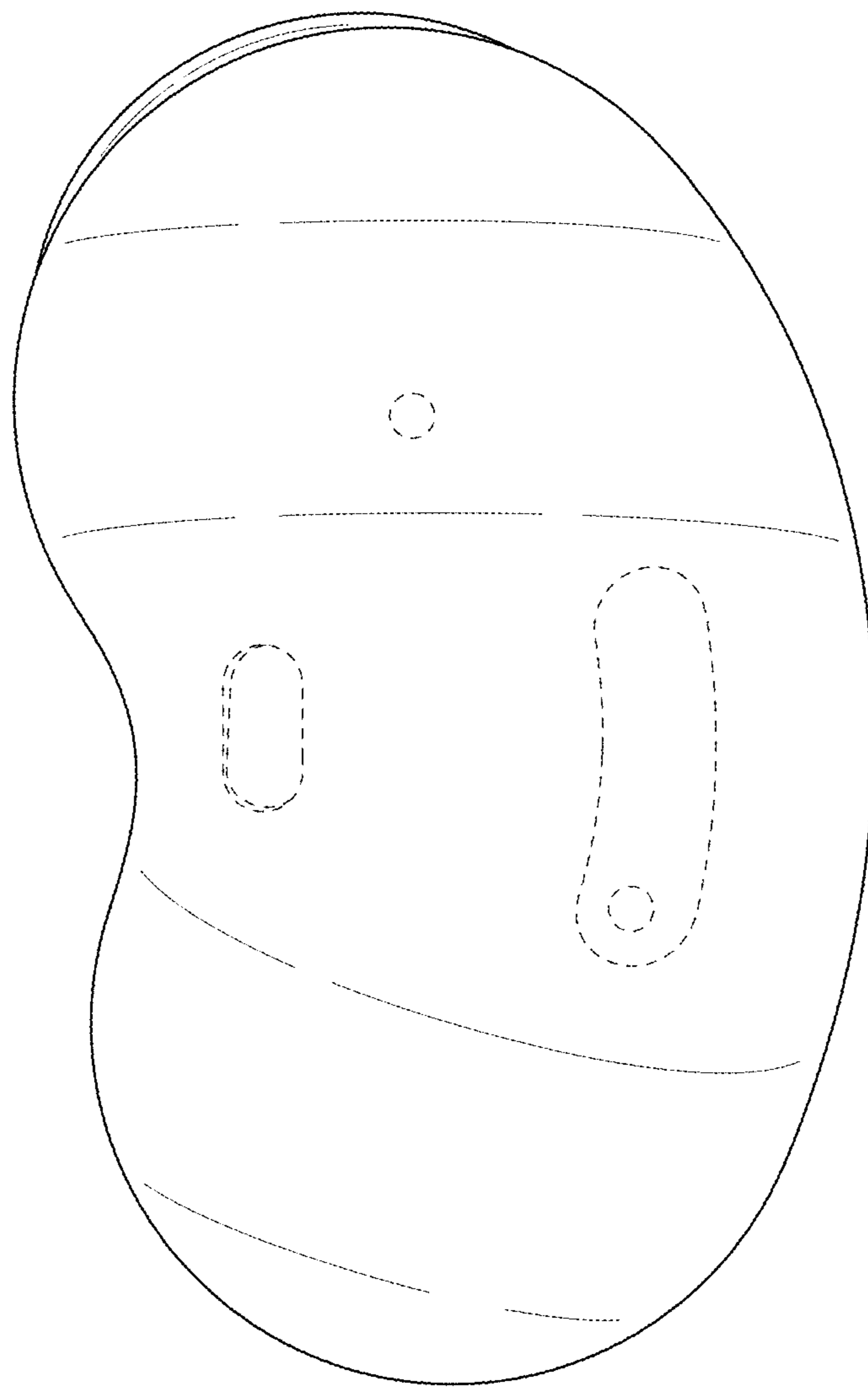

FIG. 3

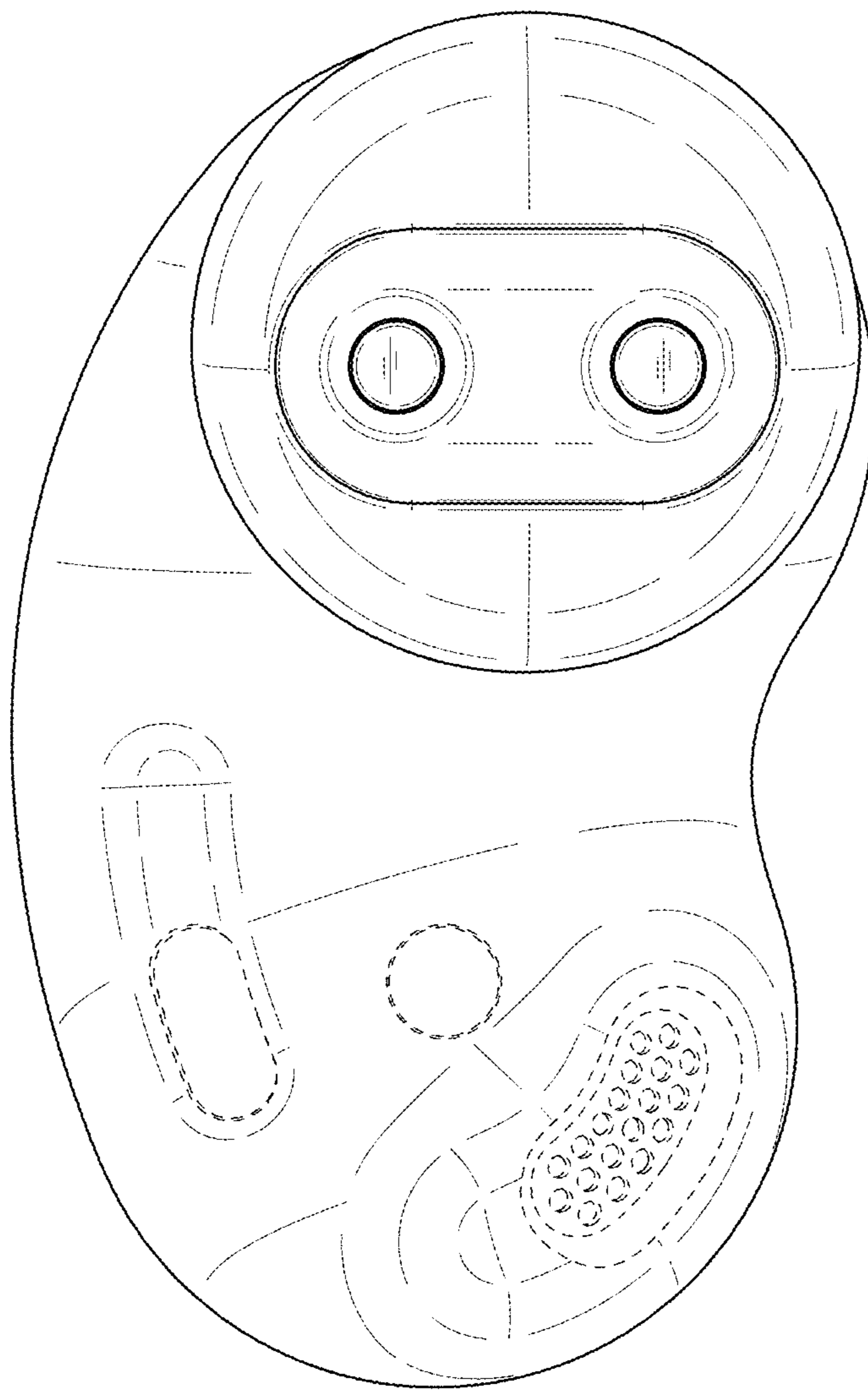

FIG. 4

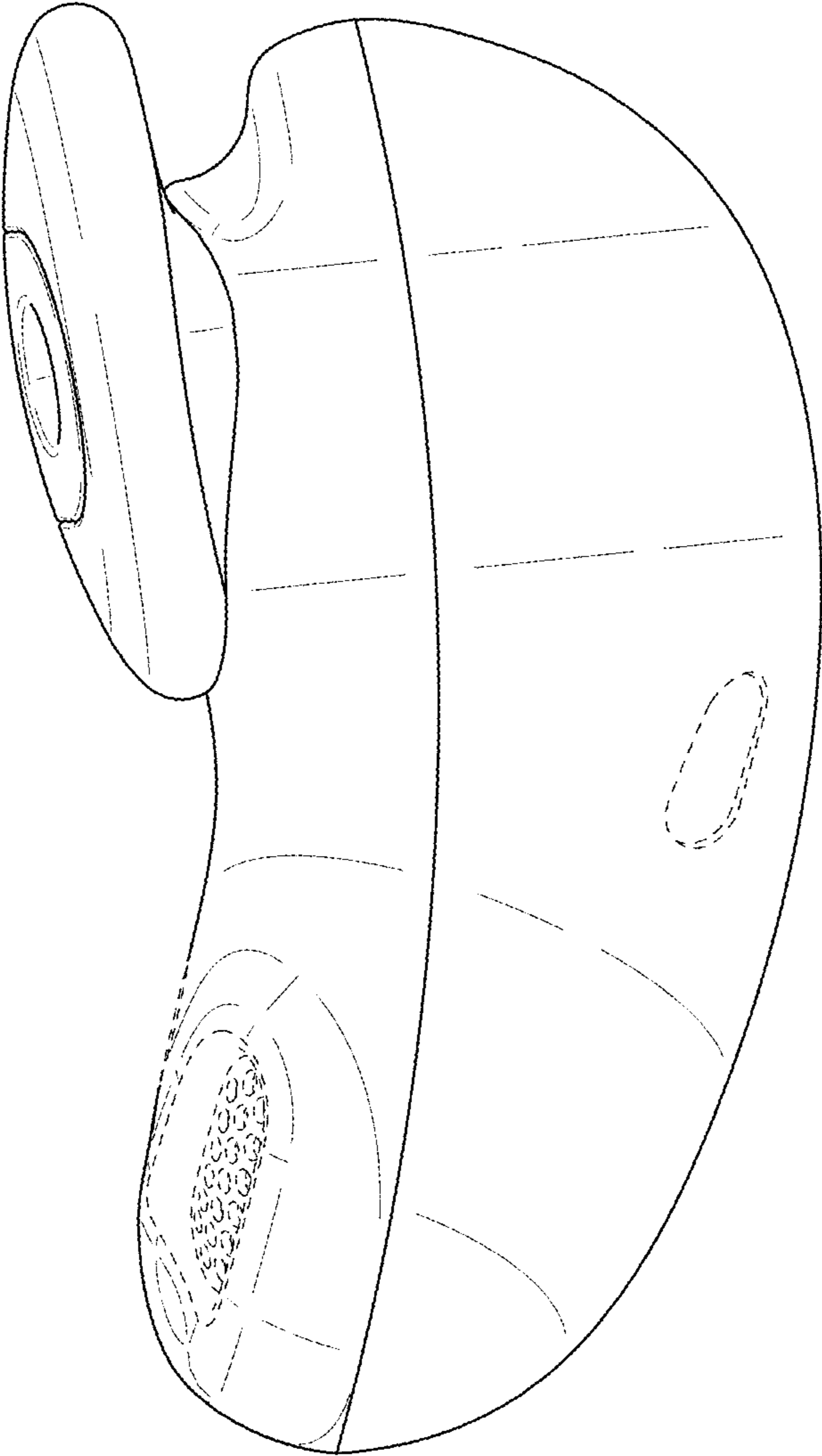

FIG. 5

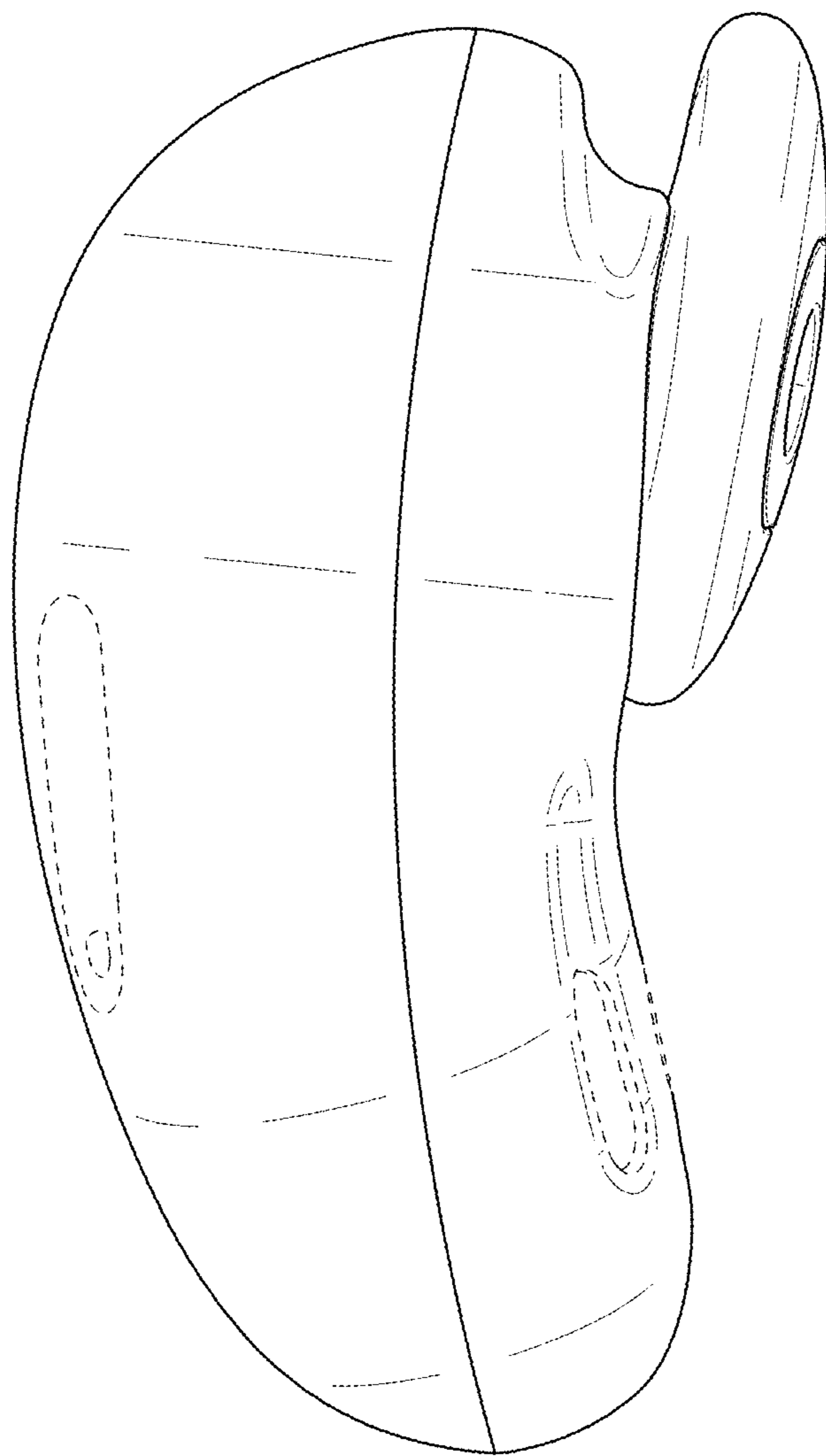

FIG. 6

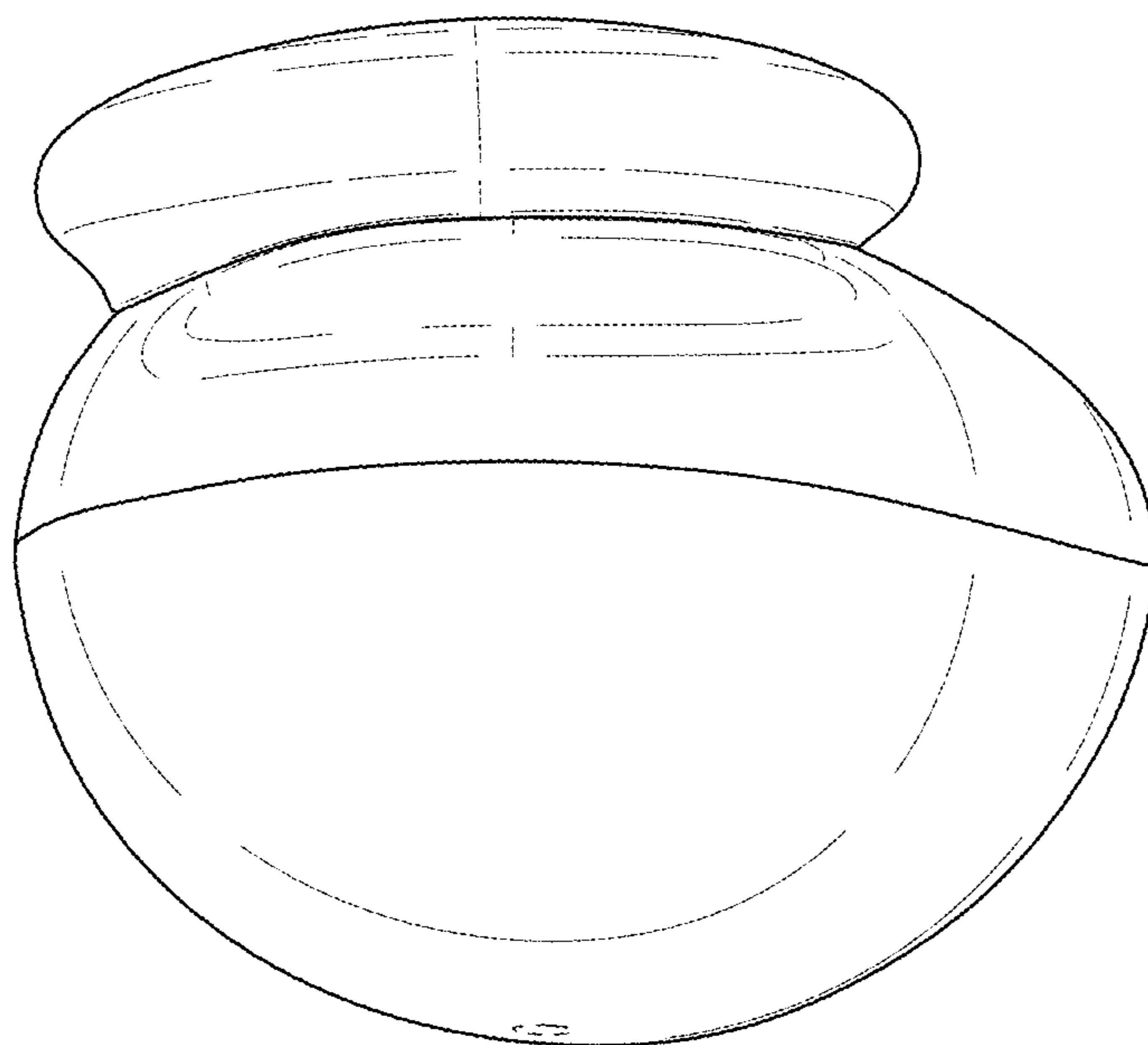



FIG. 7

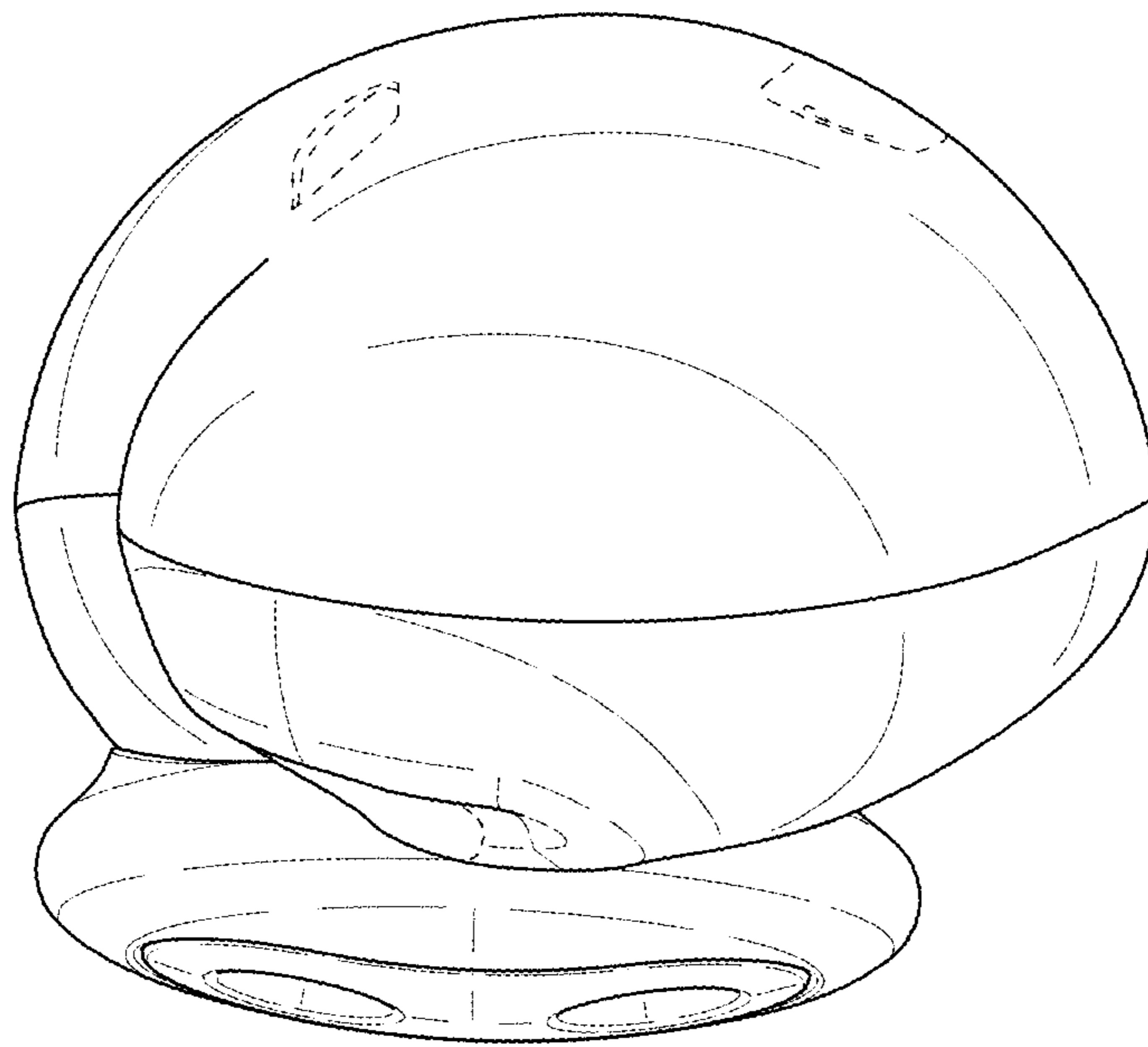

FIG. 8

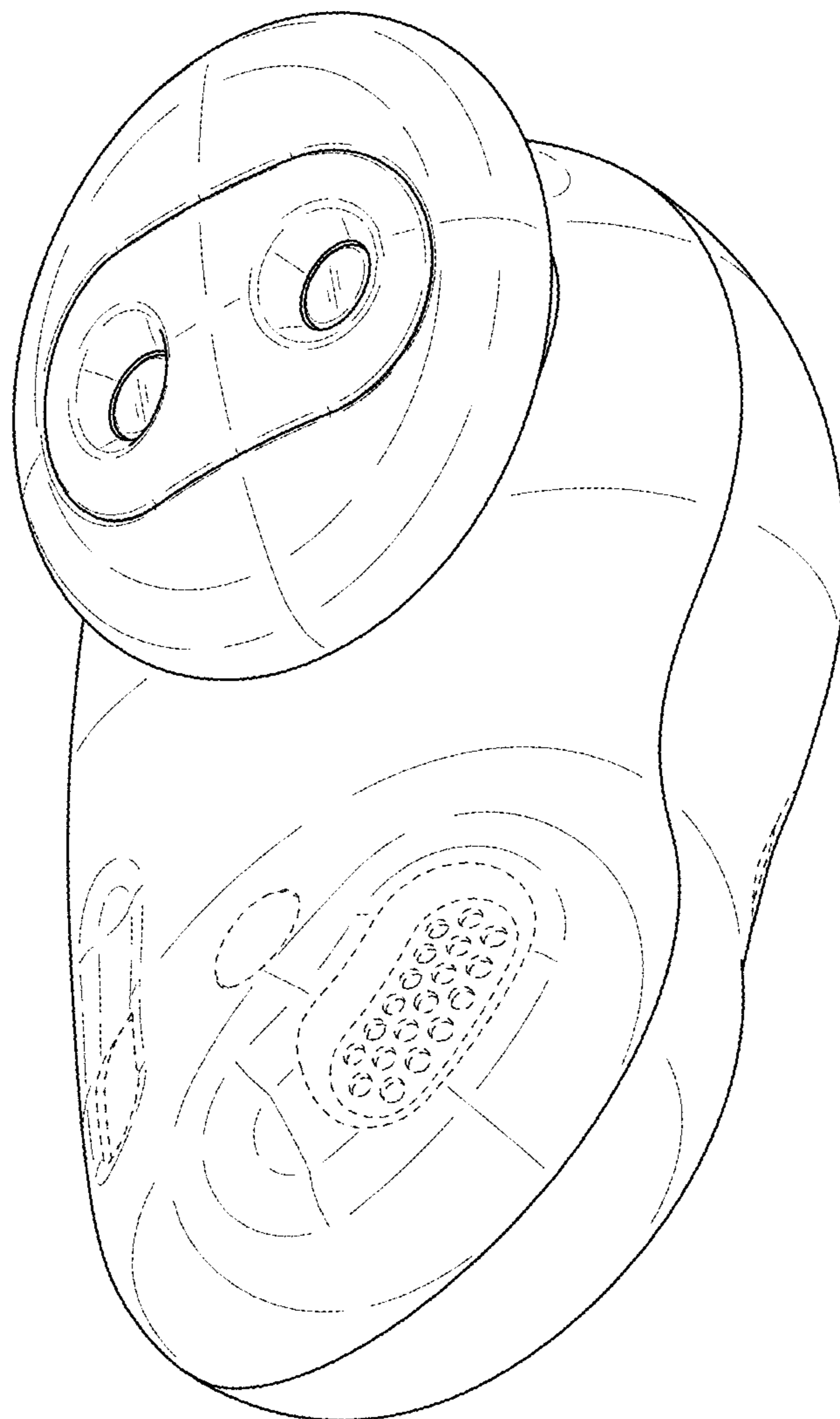

FIG. 9

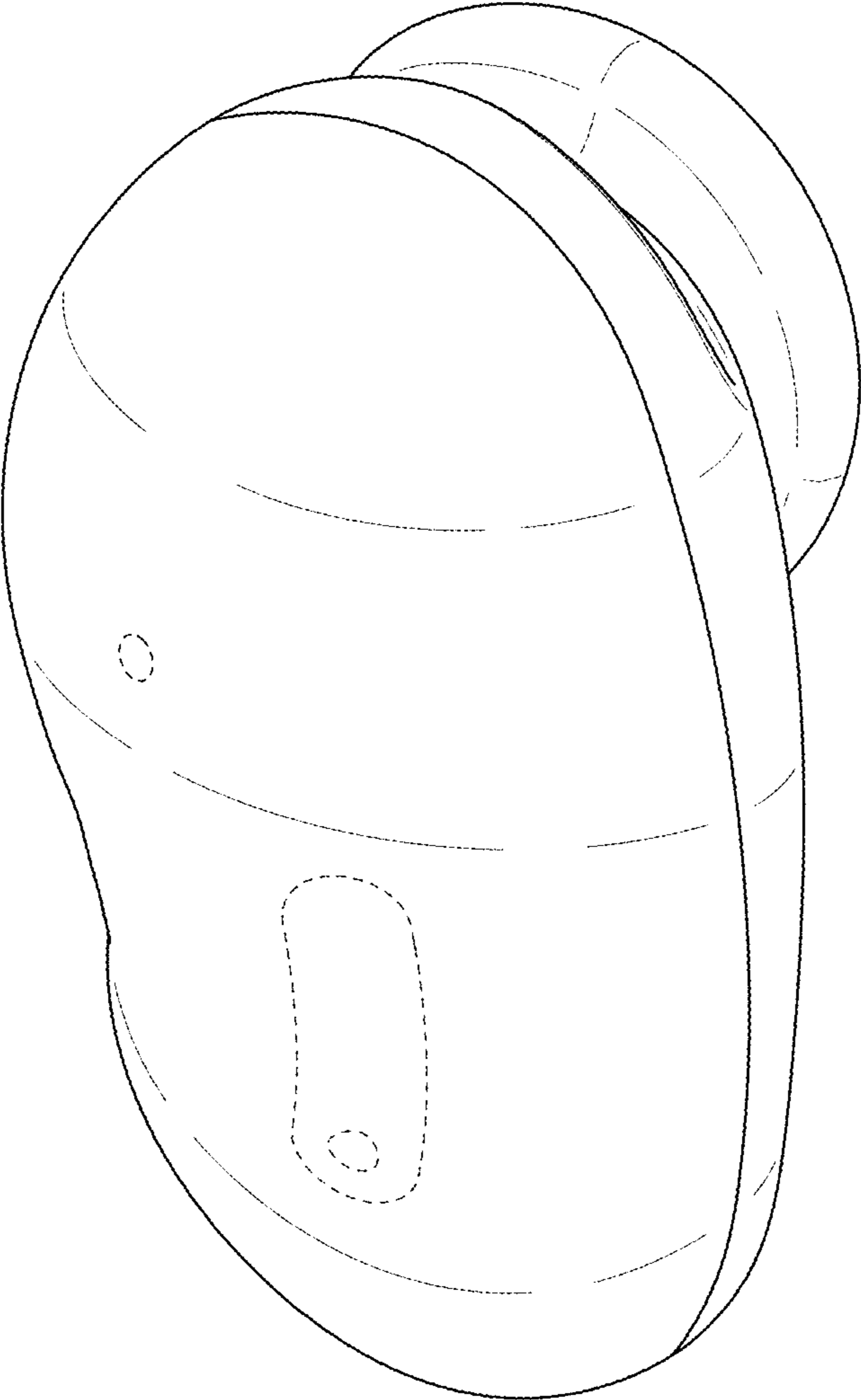

FIG. 10

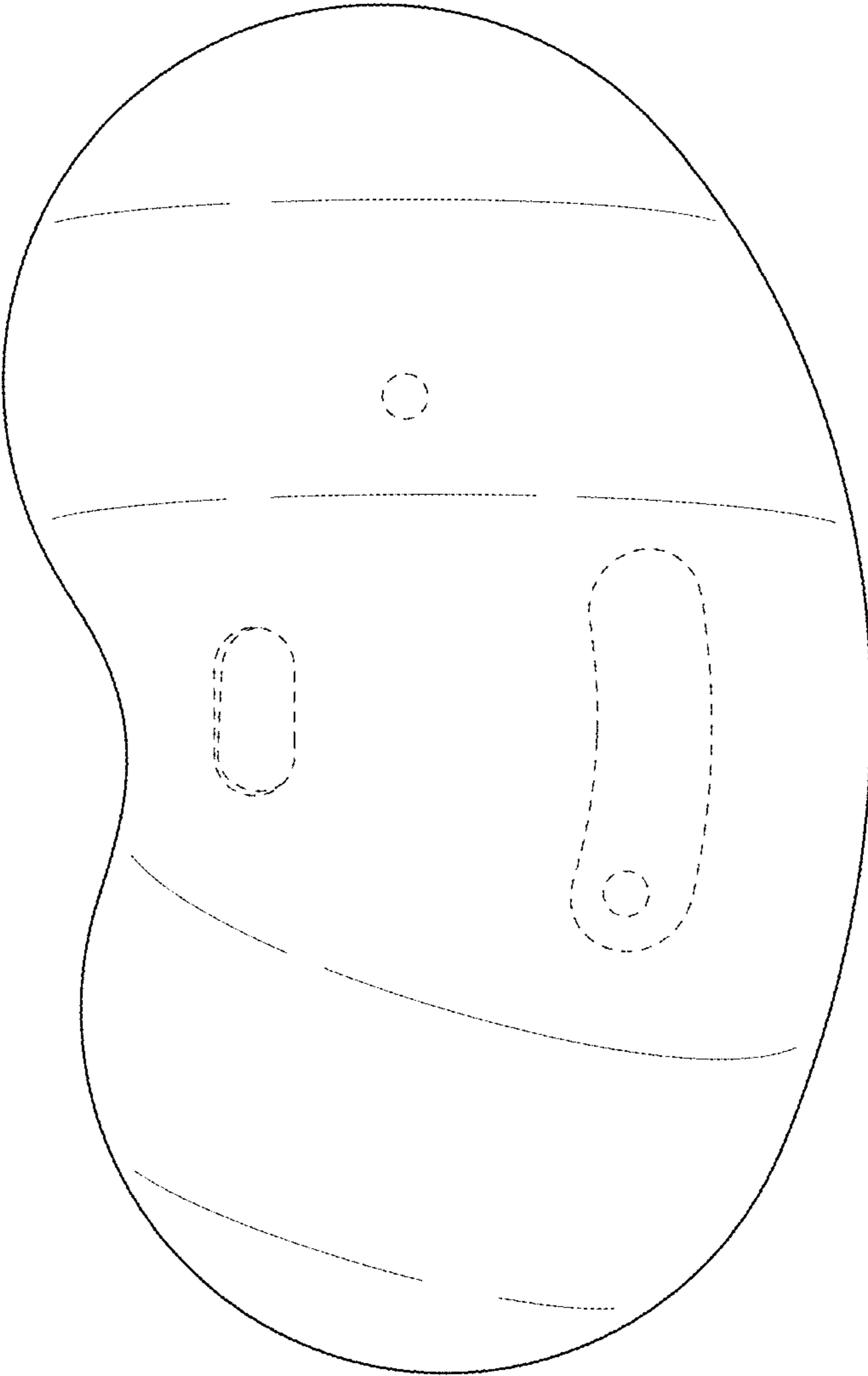

FIG. 11

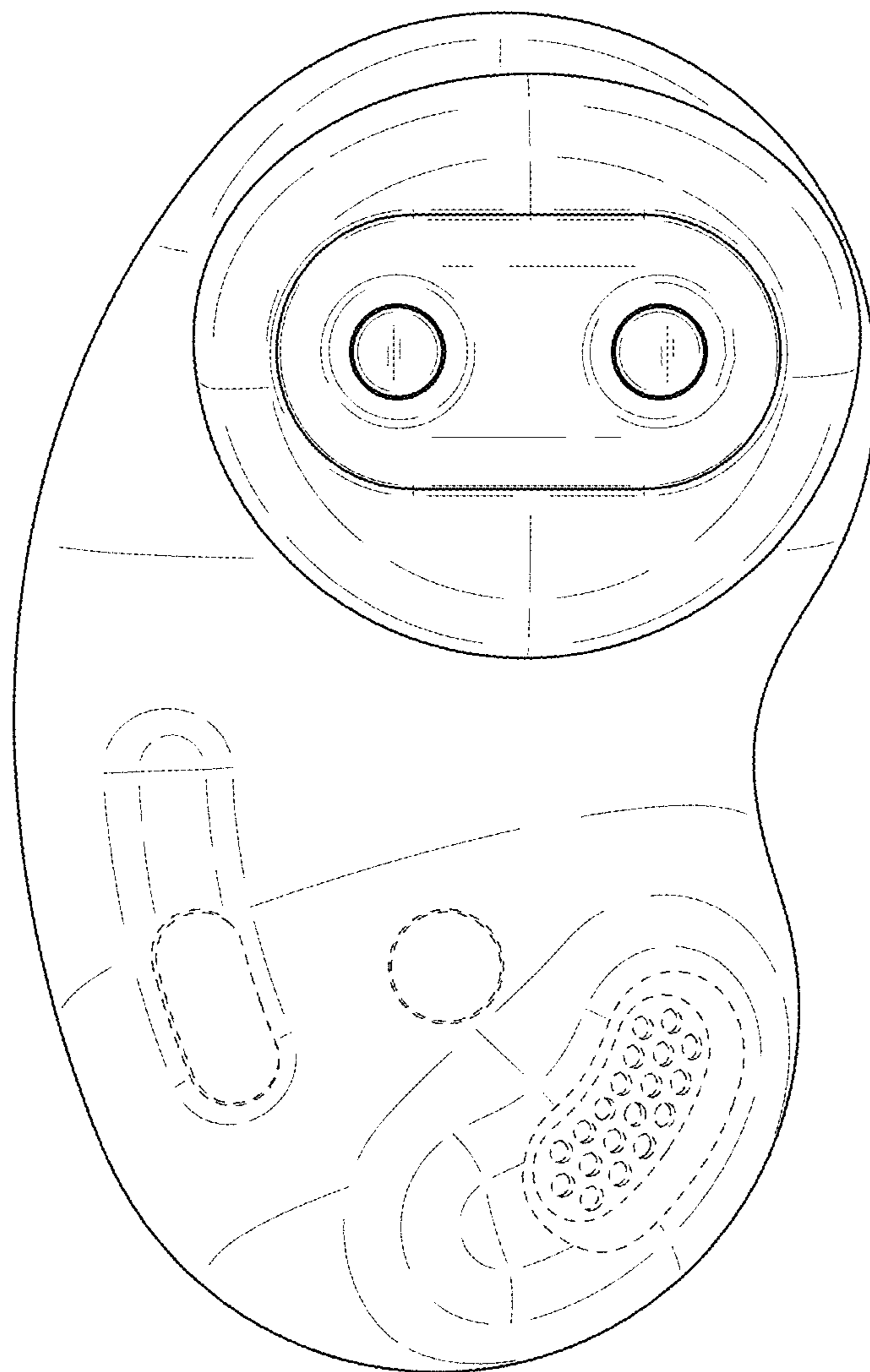

FIG. 12

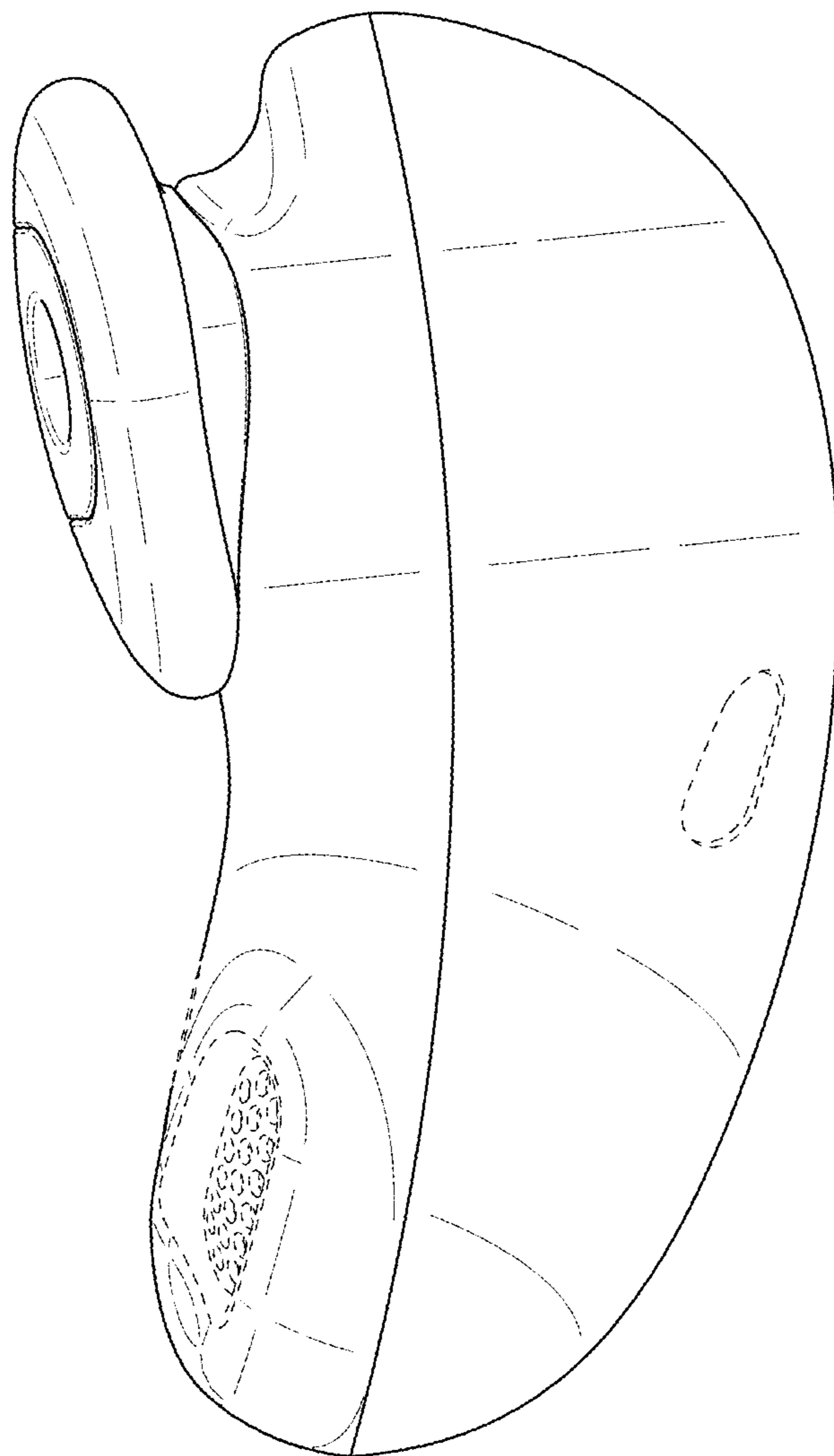

FIG. 13

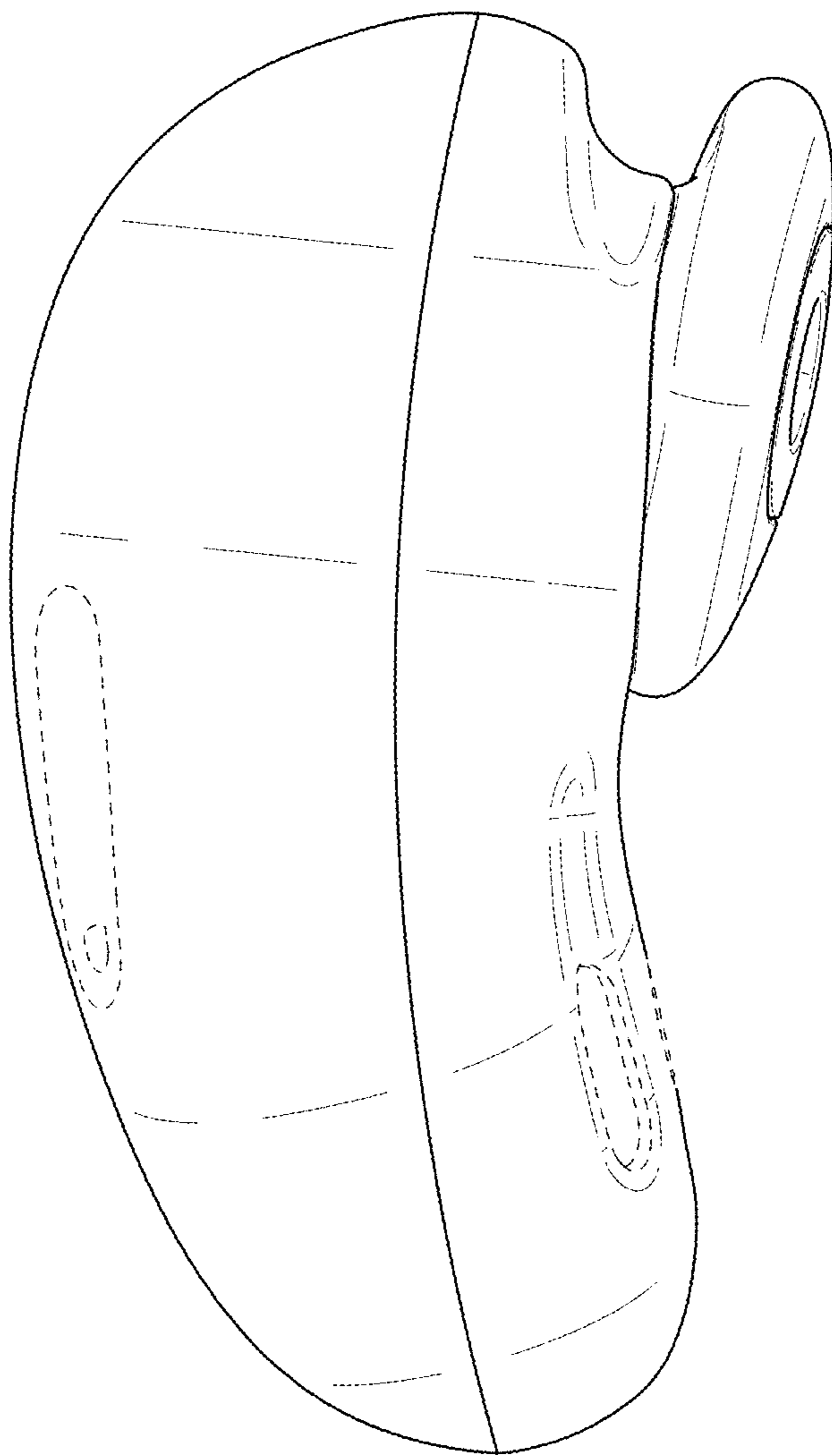

FIG. 14

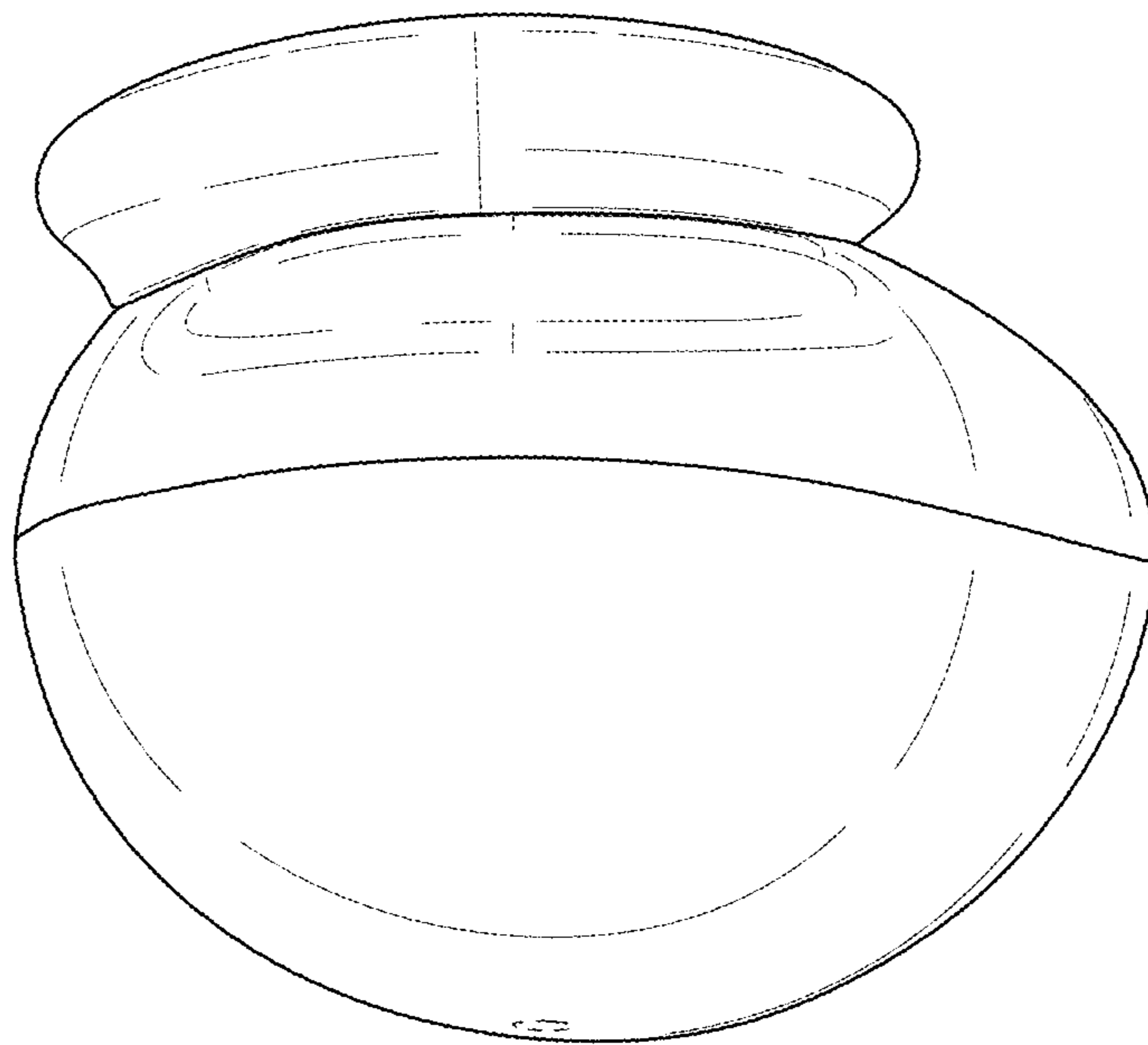



FIG. 15

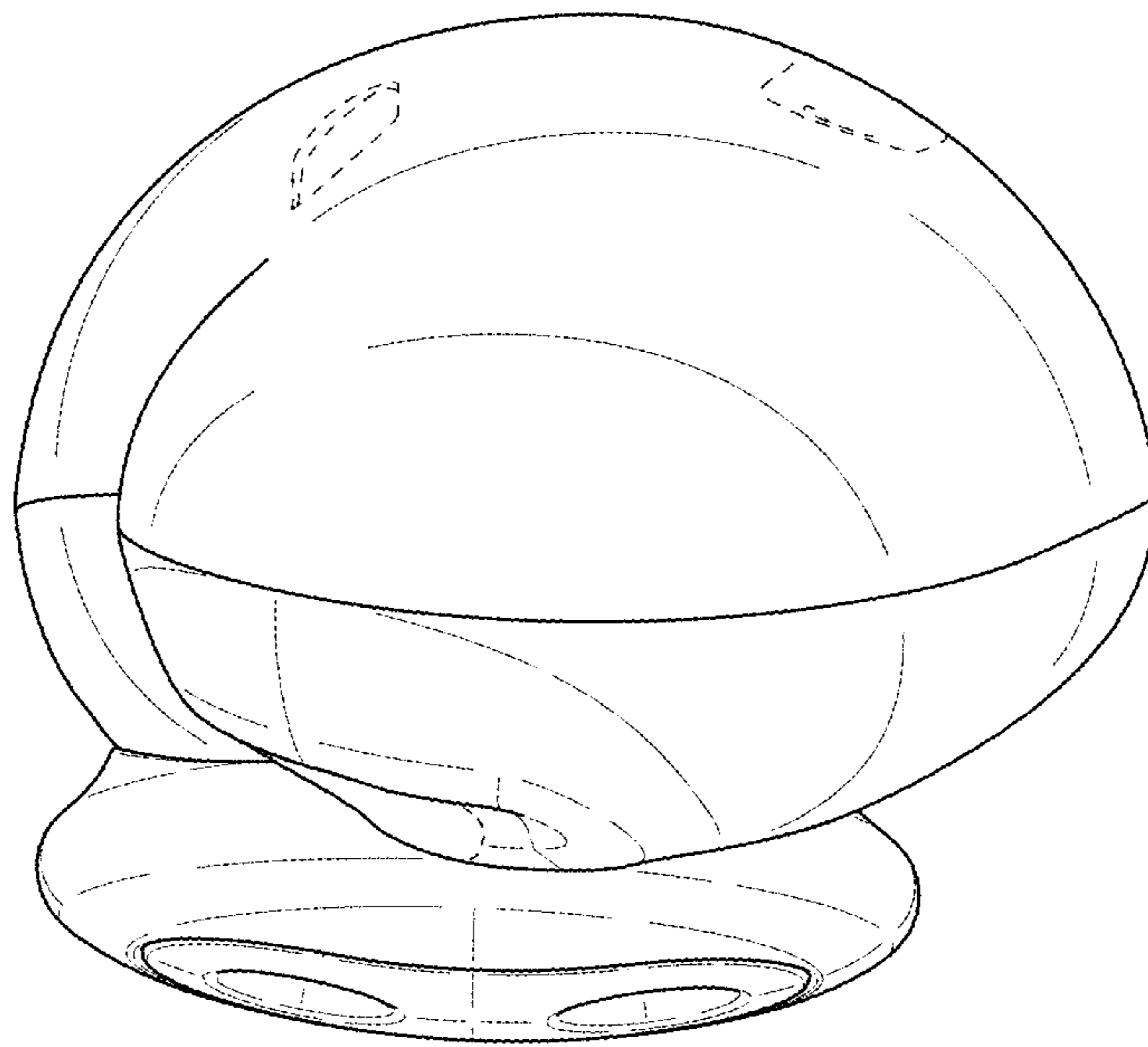

FIG. 16

