



US00D971172S

(12) **United States Design Patent** (10) **Patent No.:** **US D971,172 S**
Lee et al. (45) **Date of Patent:** **** Nov. 29, 2022**

(54) **DISPLAY DEVICE**

(71) Applicant: **Samsung Display Co., Ltd.**, Yongin-si (KR)

(72) Inventors: **Ji Heon Lee**, Hwaseong-si (KR); **Jung Hun Lee**, Hwaseong-si (KR)

(73) Assignee: **Samsung Display Co., Ltd.**, Yongin-si (KR)

(**) Term: **15 Years**

(21) Appl. No.: **29/769,568**

(22) Filed: **Feb. 5, 2021**

(30) **Foreign Application Priority Data**

Aug. 7, 2020 (KR) 30-2020-0036928

Aug. 7, 2020 (KR) 30-2020-0036929

(51) **LOC (13) Cl.** **14-03**

(52) **U.S. Cl.**
USPC **D14/138 AB**

(58) **Field of Classification Search**

USPC D14/138 G, 248, 138 C, 138 AB, 341,
D14/439, 432, 345, 138 R, 138 AA,
D14/138 AC, 138 AD, 371, 374
(Continued)

(56) **References Cited**

U.S. PATENT DOCUMENTS

D716,751 S * 11/2014 Lee D14/345

D749,576 S * 2/2016 Park D14/203.4

(Continued)

Primary Examiner — Bridget L Eland

(74) *Attorney, Agent, or Firm* — Lewis Roca Rothgerber
Christie LLP

(57) **CLAIM**

The ornamental design for a display device, as shown and described.

DESCRIPTION

FIG. 1 is a front perspective view of a first embodiment of the display device shown in a first folded state;

FIG. 2 is a front view thereof;

FIG. 3 is a rear view thereof;

FIG. 4 is a left side view thereof;

FIG. 5 is a right side view thereof;

FIG. 6 is a top view thereof; and

FIG. 7 is a bottom view thereof.

FIG. 8 is a front perspective view of the display device of FIG. 1, shown in a second folded state;

FIG. 9 is a front view thereof;

FIG. 10 is a rear view thereof;

FIG. 11 is a left side view thereof;

FIG. 12 is a right side view thereof;

FIG. 13 is a top view thereof; and

FIG. 14 is a bottom view thereof.

FIG. 15 is a front perspective view of the display device of FIG. 1, shown in an unfolded state;

FIG. 16 is a front view thereof;

FIG. 17 is a rear view thereof;

FIG. 18 is a left side view thereof;

FIG. 19 is a right side view thereof;

FIG. 20 is a top view thereof; and

FIG. 21 is a bottom view thereof.

FIG. 22 is a front perspective view of a second embodiment of a display device, shown in a first folded state;

FIG. 23 is a front view thereof;

FIG. 24 is a rear view thereof;

FIG. 25 is a left side view thereof;

FIG. 26 is a right side view thereof;

FIG. 27 is a top view thereof; and

FIG. 28 is a bottom view thereof.

FIG. 29 is a front perspective view of the display device of FIG. 22, shown in a second folded state;

FIG. 30 is a front view thereof;

FIG. 31 is a rear view thereof;

FIG. 32 is a left side view thereof;

FIG. 33 is a right side view thereof;

(Continued)

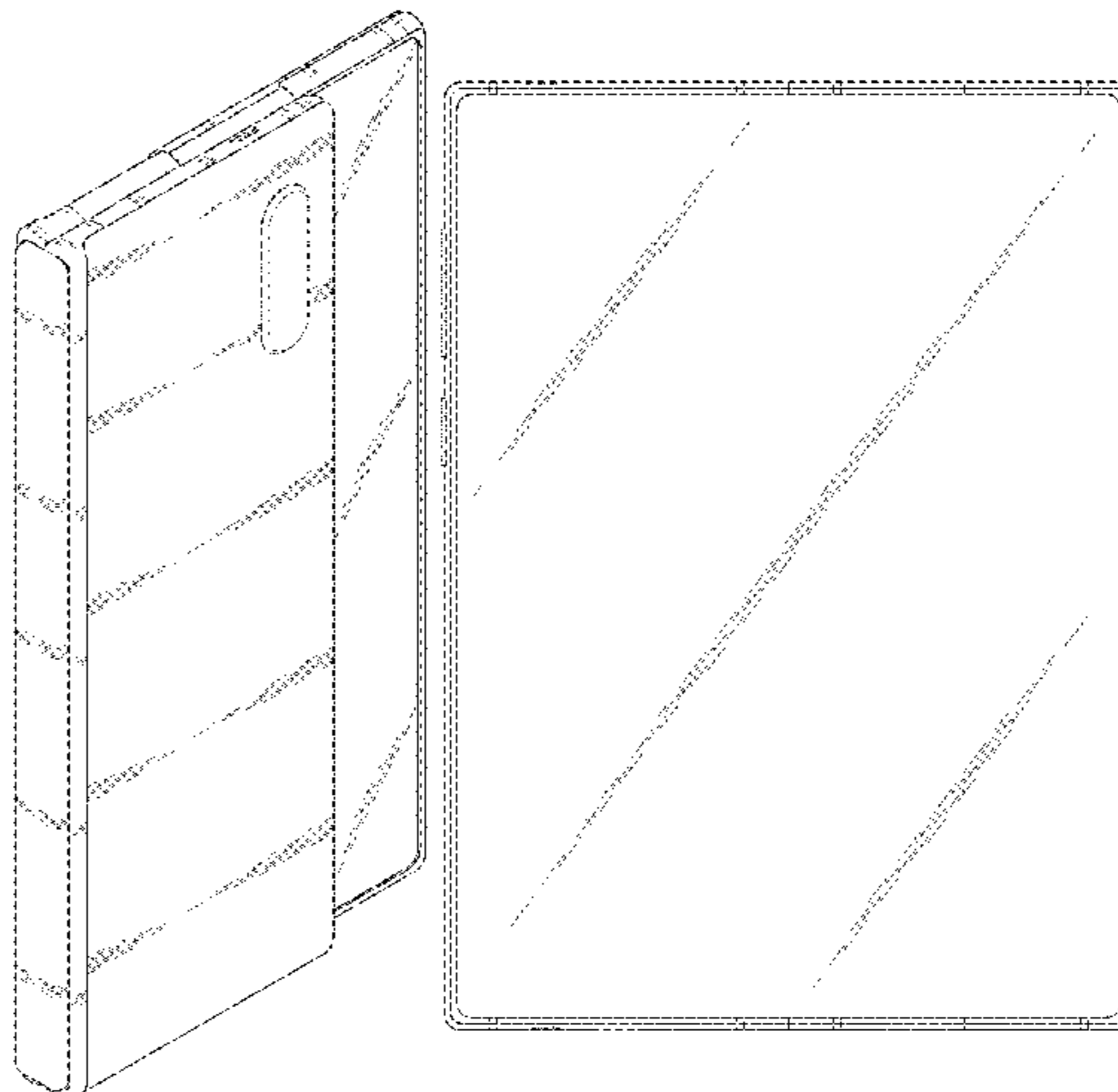

FIG. 34 is a top view thereof; and
FIG. 35 is a bottom view thereof.
FIG. 36 is a front perspective view of the display device of
FIG. 22, shown in an unfolded state;
FIG. 37 is a front view thereof;
FIG. 38 is a rear view thereof;
FIG. 39 is a left side view thereof;
FIG. 40 is a right side view thereof;
FIG. 41 is a top view thereof; and,
FIG. 42 is a bottom view thereof.
In the drawings, the broken lines illustrate portions of the
display device that form no part of the claimed design in the
embodiments in which they are shown.

1 Claim, 42 Drawing Sheets

(58) **Field of Classification Search**
CPC H04M 1/0202; H04M 1/0235; H04M
1/0237; H04M 1/0239; H04M 1/0266;

H04M 1/0268; H04M 1/027; H04M
1/0295; H04M 1/02; H04M 1/0279;
H04M 1/0283

See application file for complete search history.

(56)

References Cited

U.S. PATENT DOCUMENTS

D772,225	S	*	11/2016	Kim	D14/341
D786,210	S	*	5/2017	Lee	D14/345
D819,628	S	*	6/2018	Park	D14/248
D839,267	S	*	1/2019	Park	D14/345
D840,394	S	*	2/2019	Son	D14/345
D841,646	S	*	2/2019	Son	D14/345
10,263,982	B2		4/2019	Kim		
D894,145	S	*	8/2020	Lee	D14/138 AB
D910,620	S	*	2/2021	Lee	D14/341
D921,601	S	*	6/2021	Lee	D14/138 AB
D922,345	S	*	6/2021	Bae	D14/345
2016/0179236	A1	*	6/2016	Shin	G06F 3/0487 345/173

* cited by examiner

FIG. 1

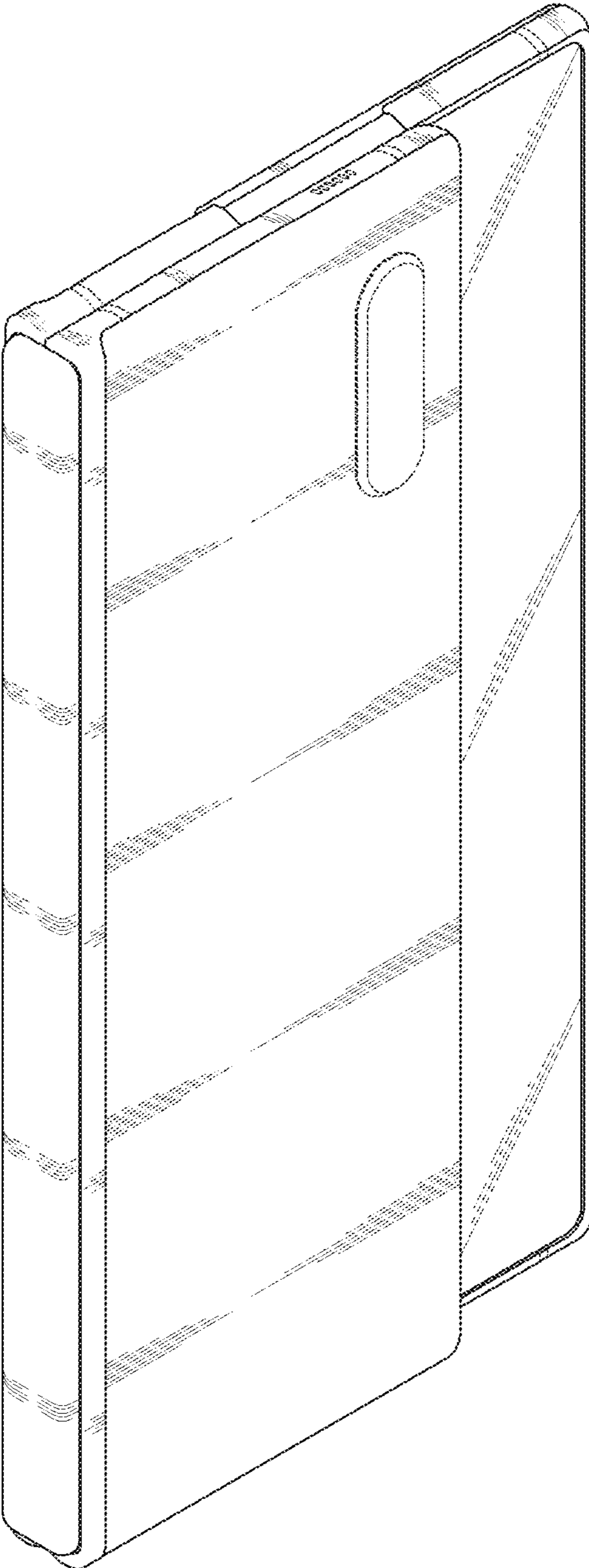

FIG. 2

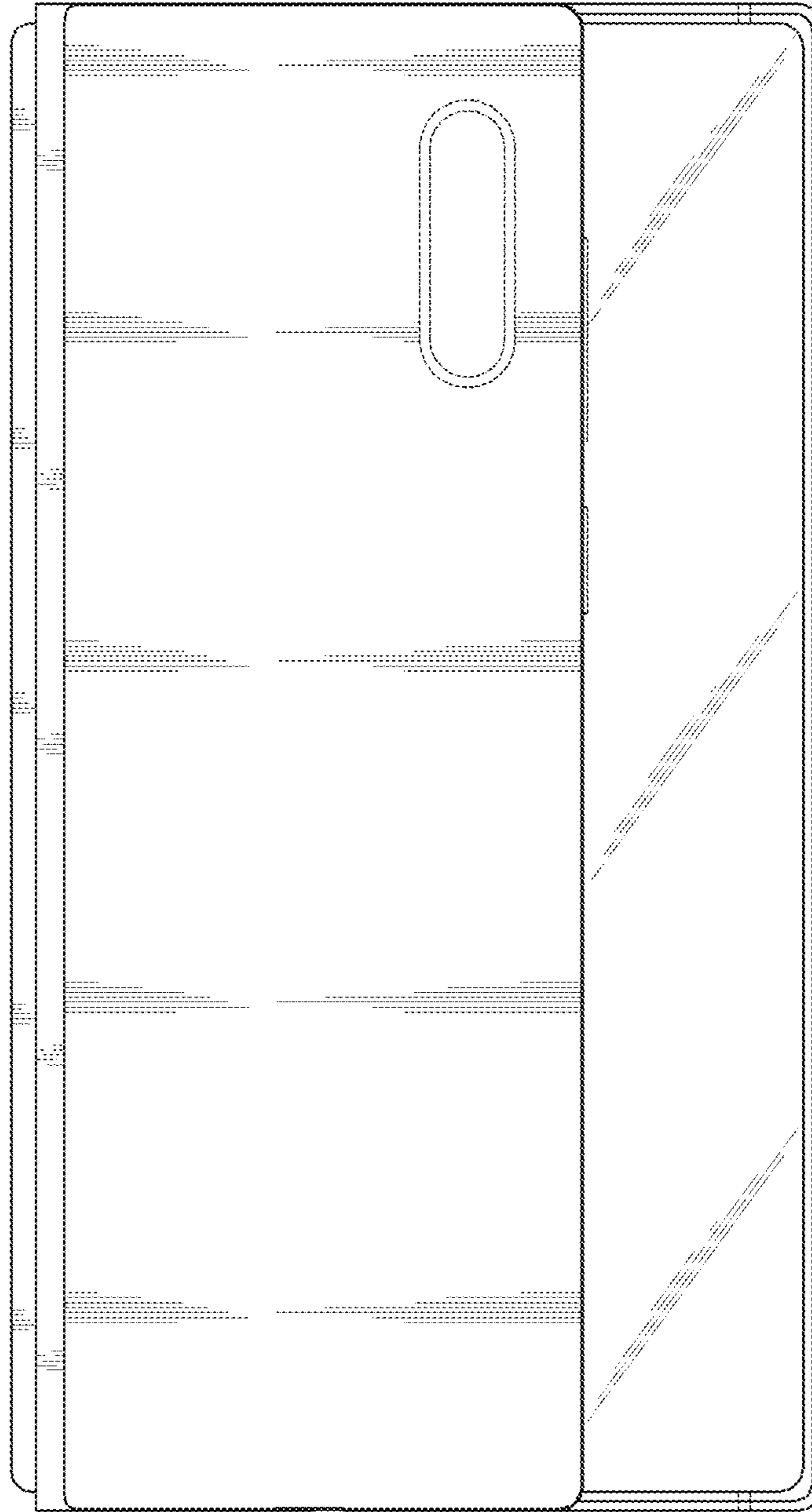

FIG. 3

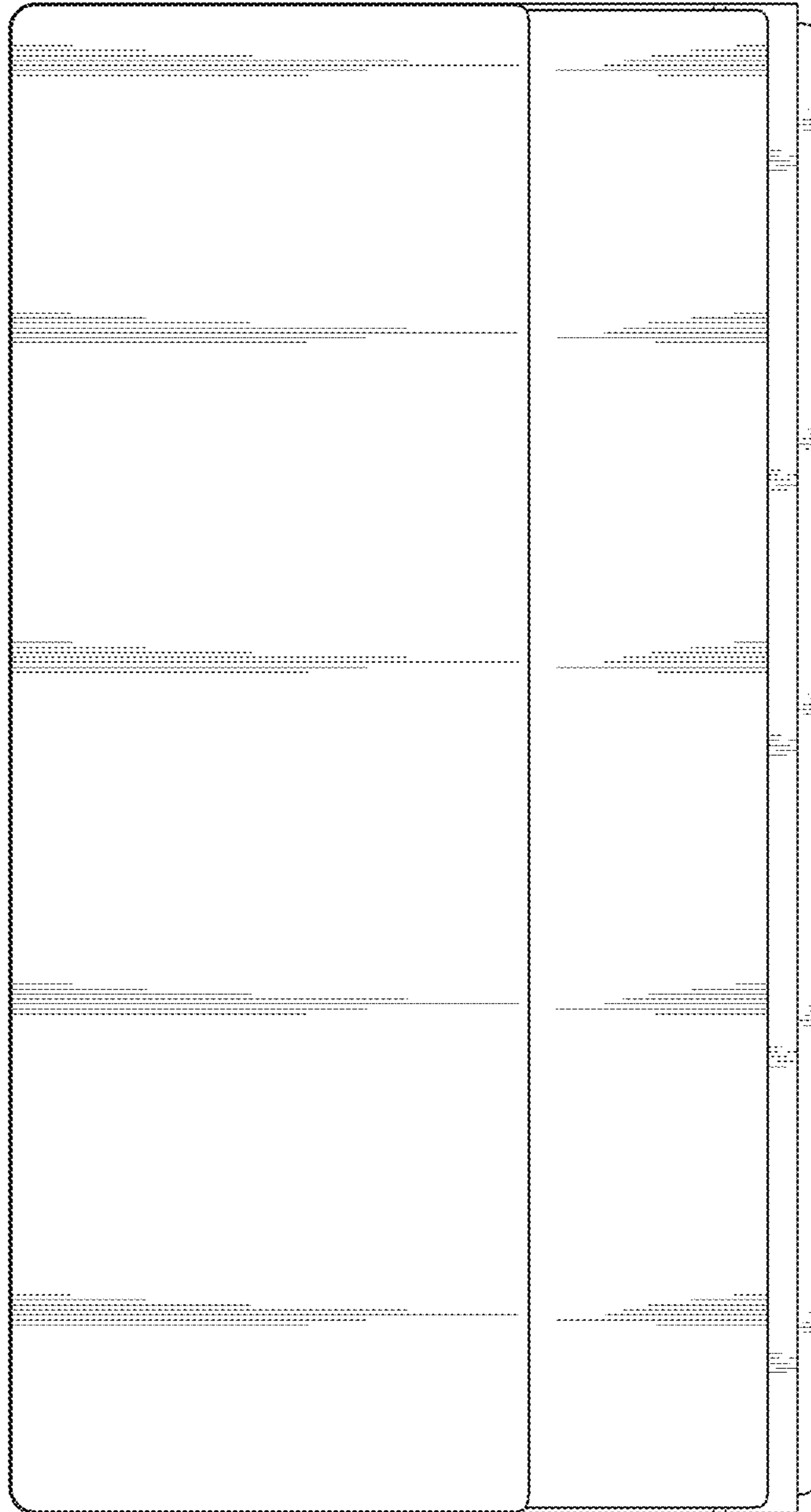

FIG. 4

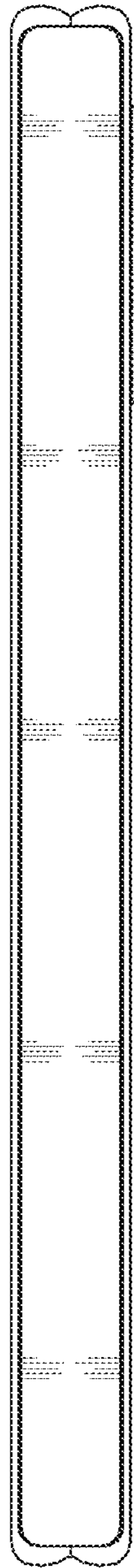

FIG. 5

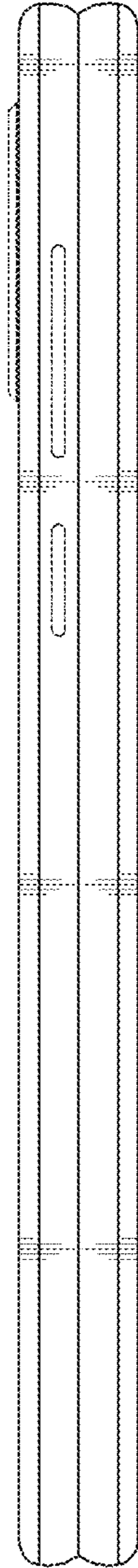

FIG. 6

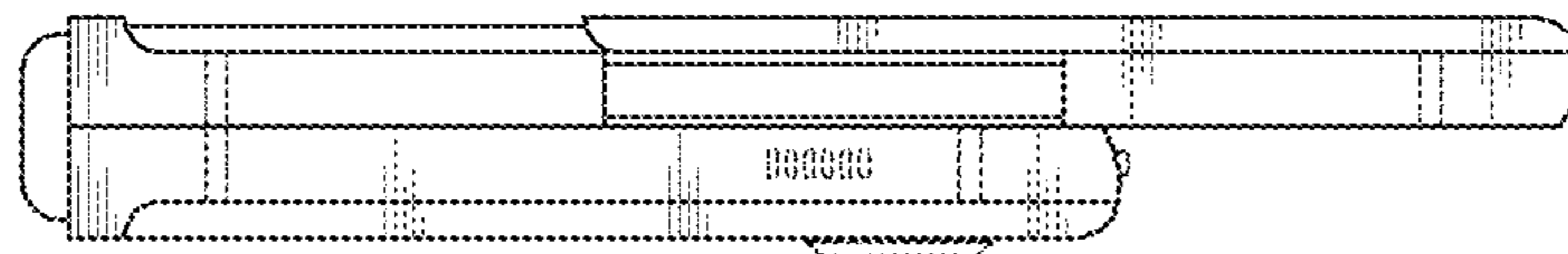

FIG. 7

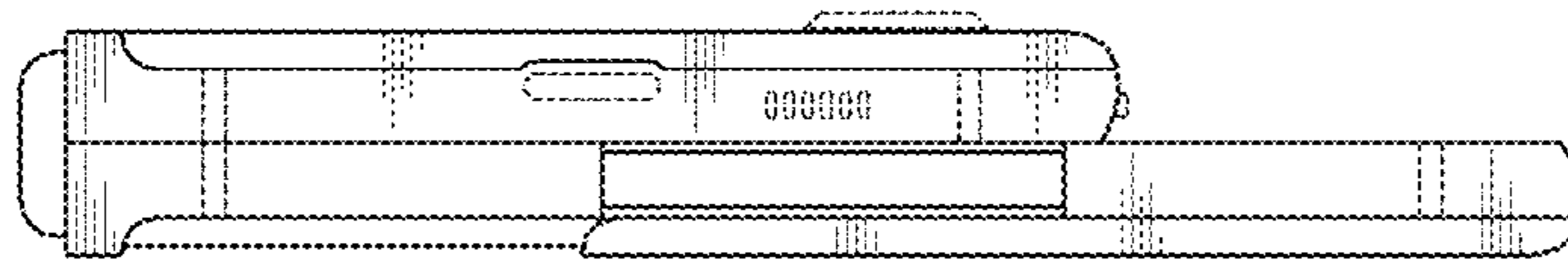

FIG. 8

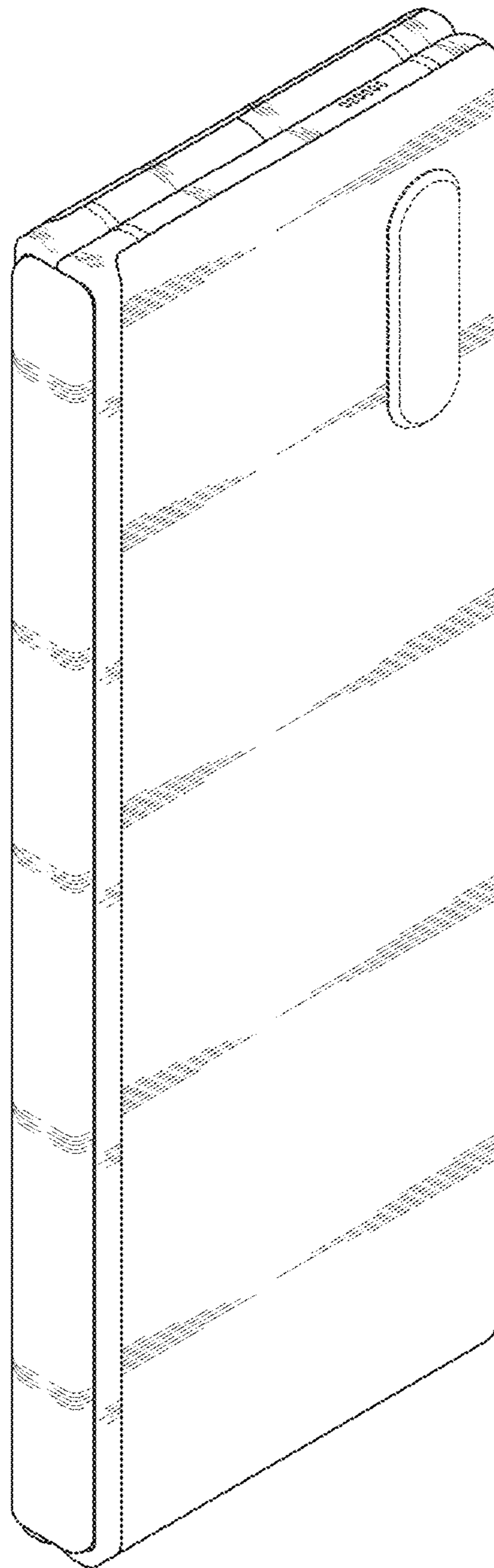

FIG. 9

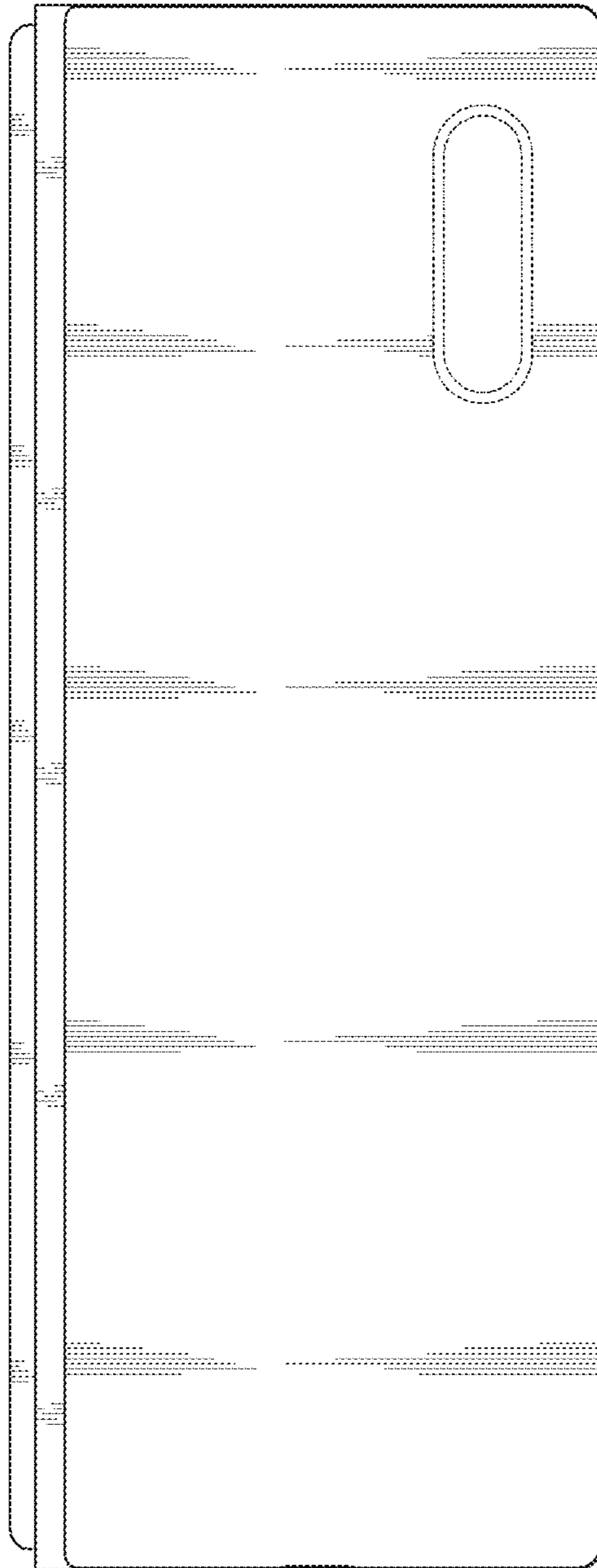

FIG. 10

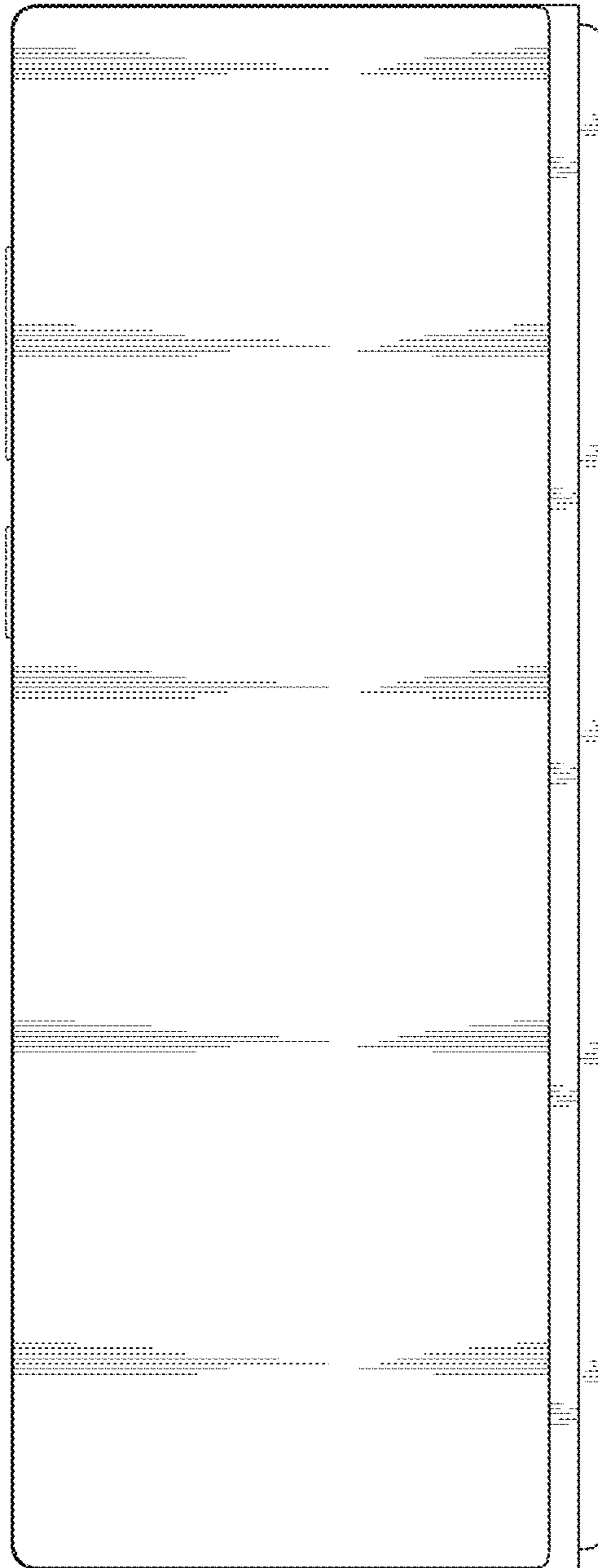

FIG. 11

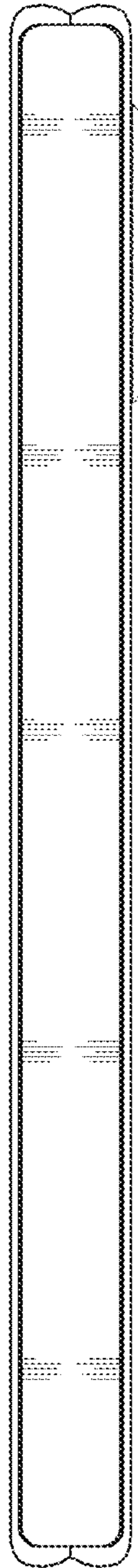

FIG. 12

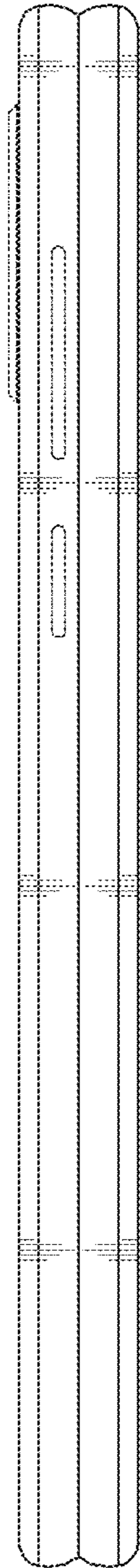

FIG. 13

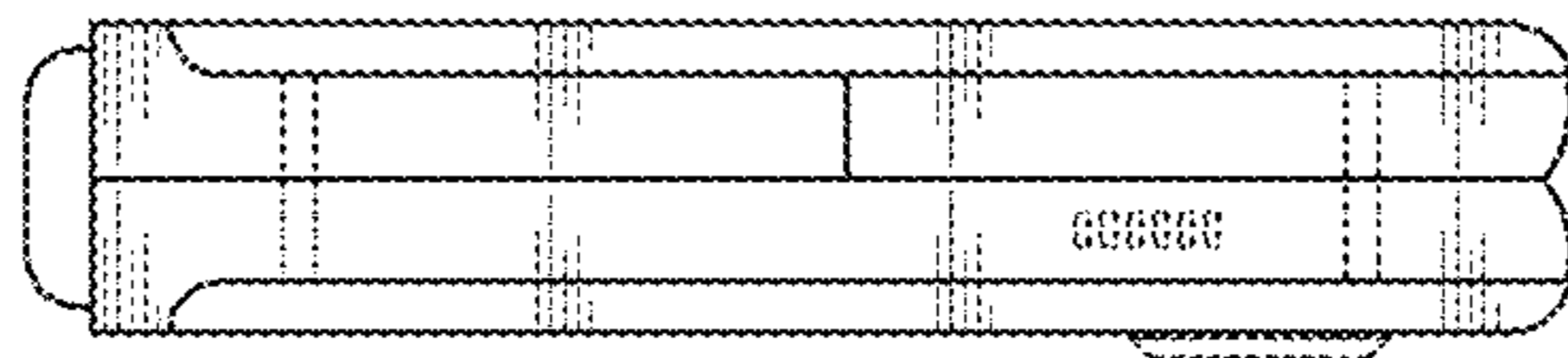

FIG. 14

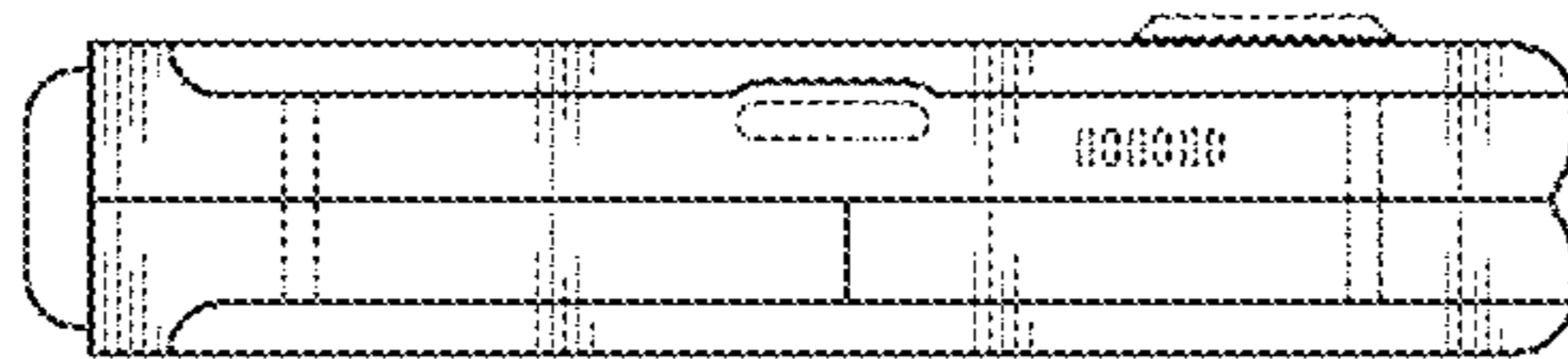

FIG. 15

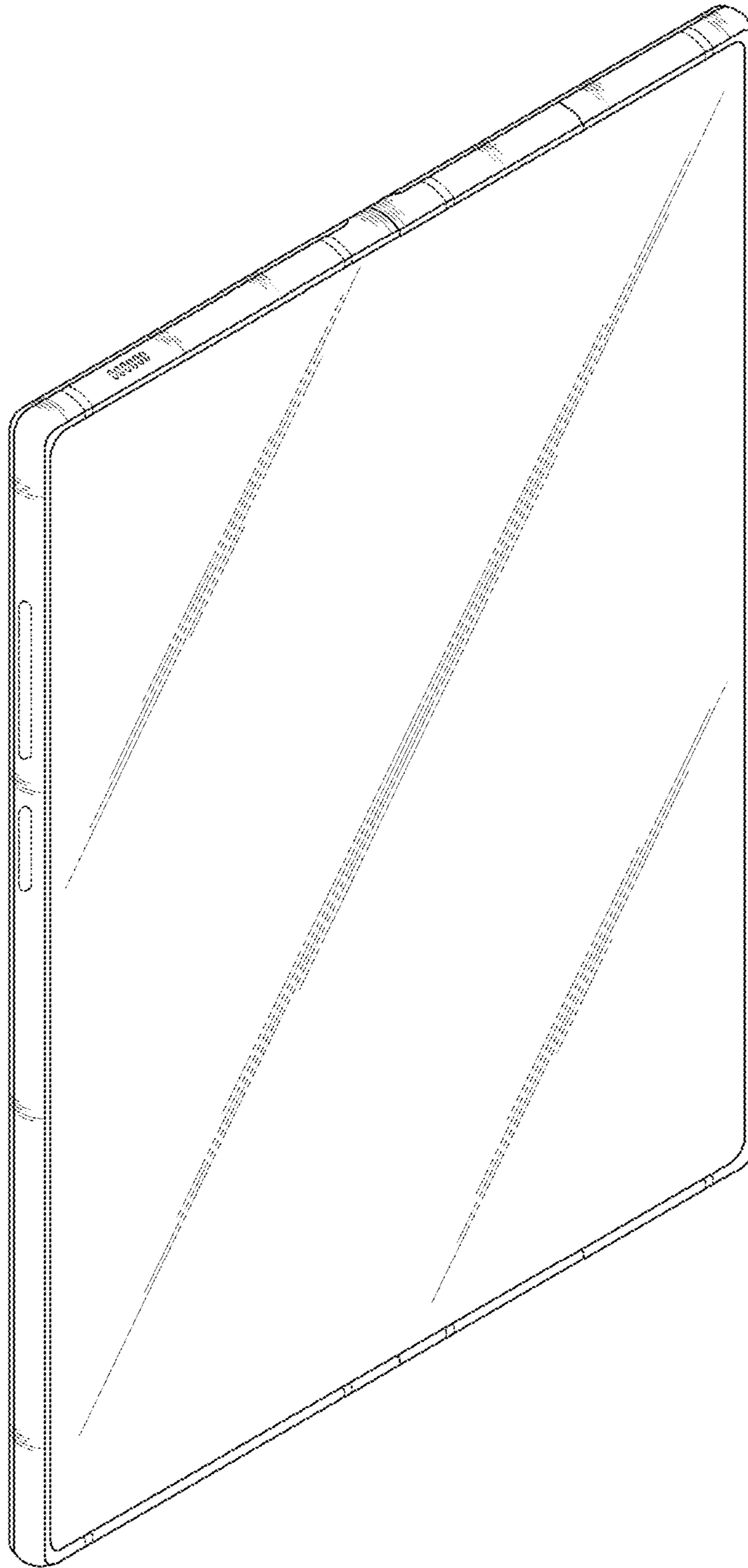

FIG. 16

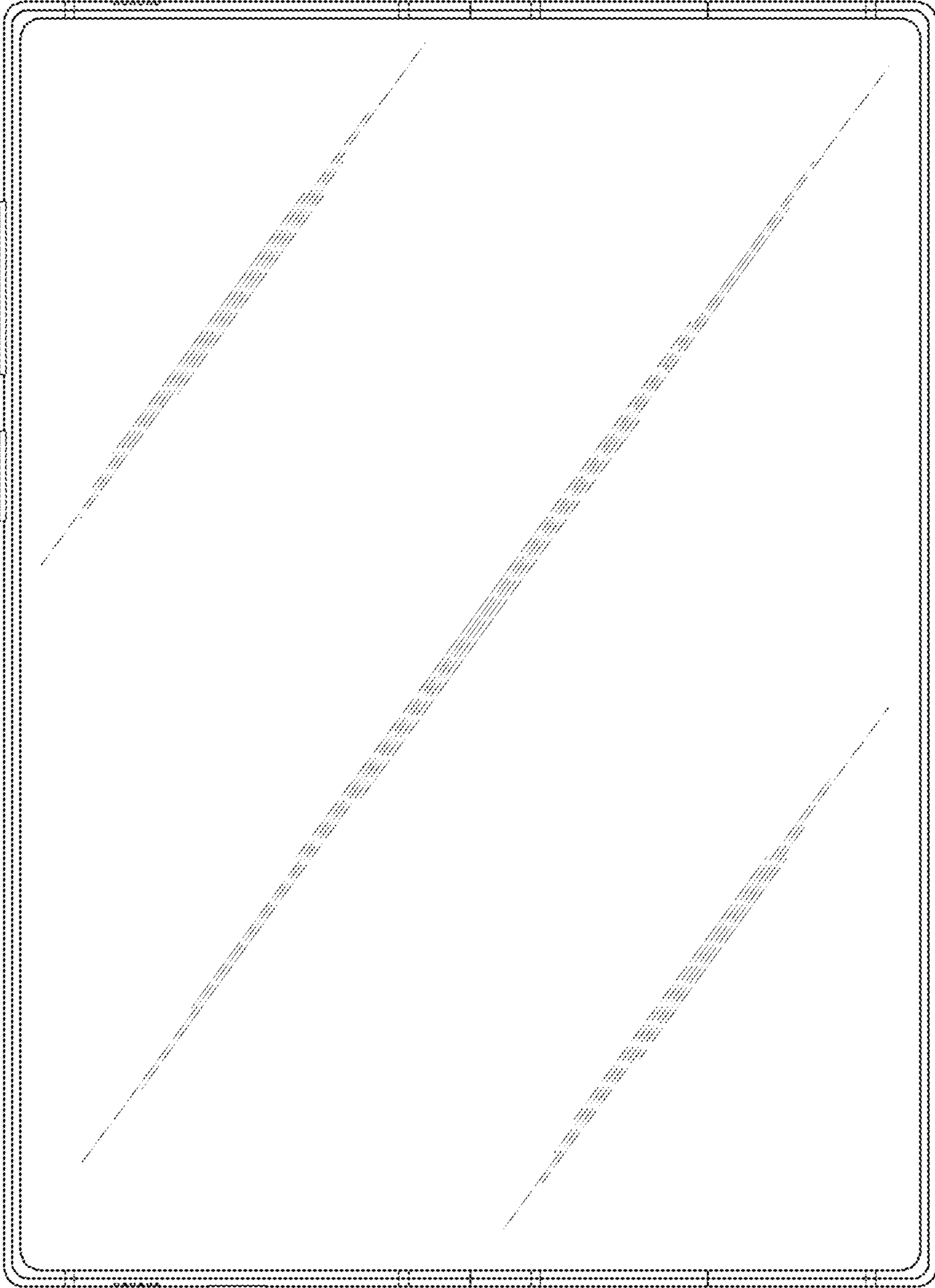

FIG. 17

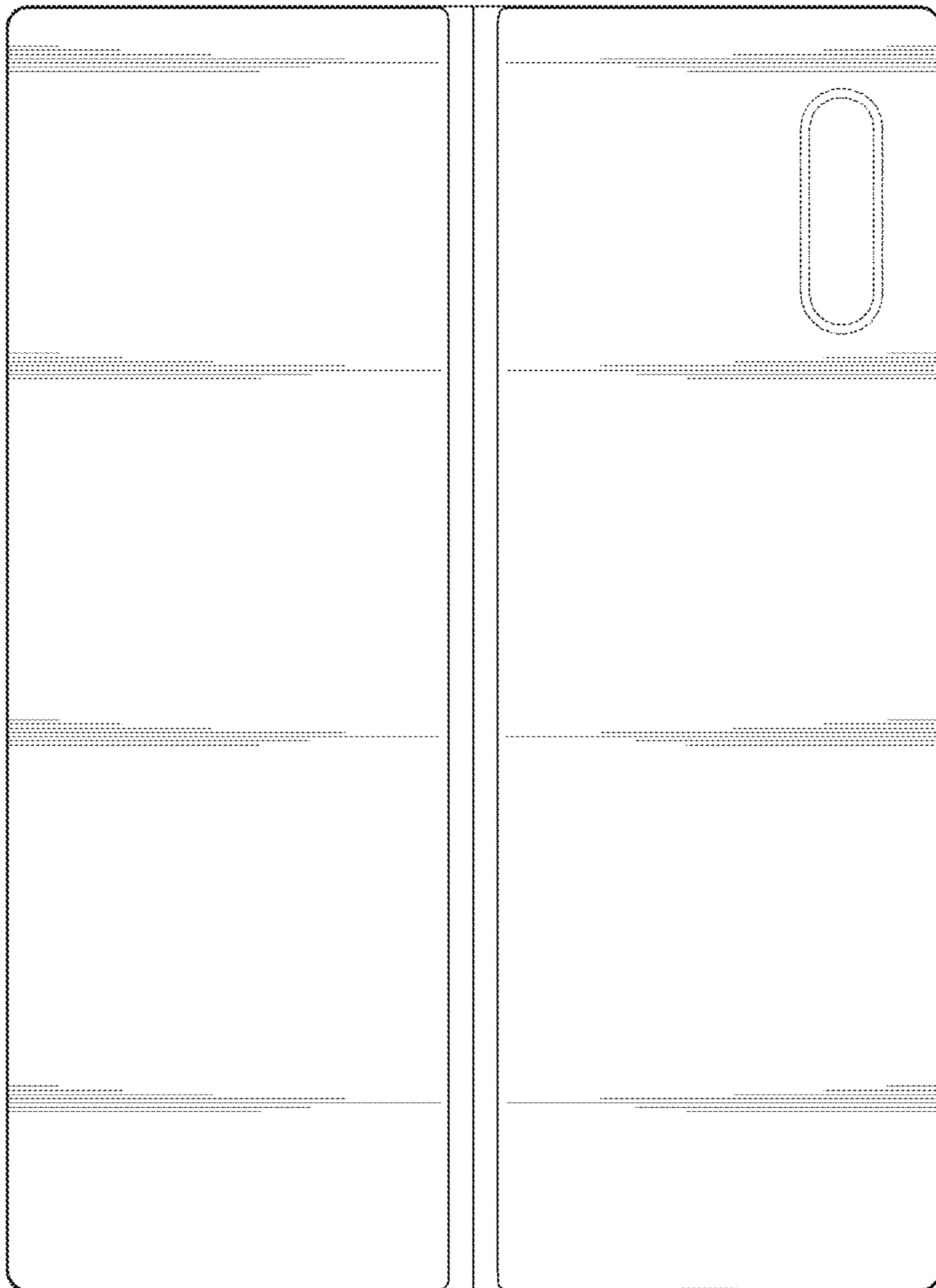

FIG. 18

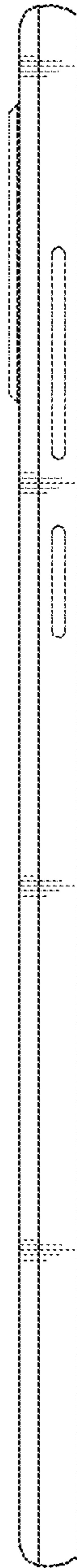

FIG. 19

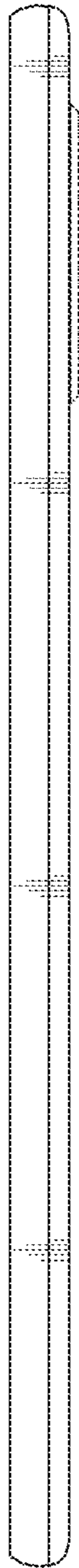

FIG. 20

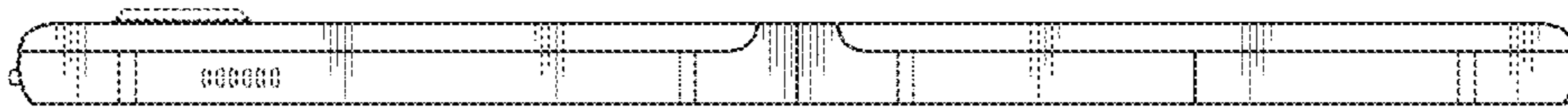

FIG. 21

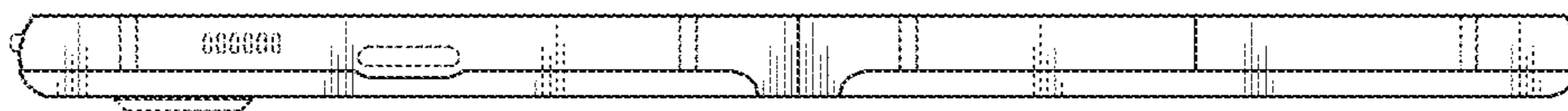

FIG. 22

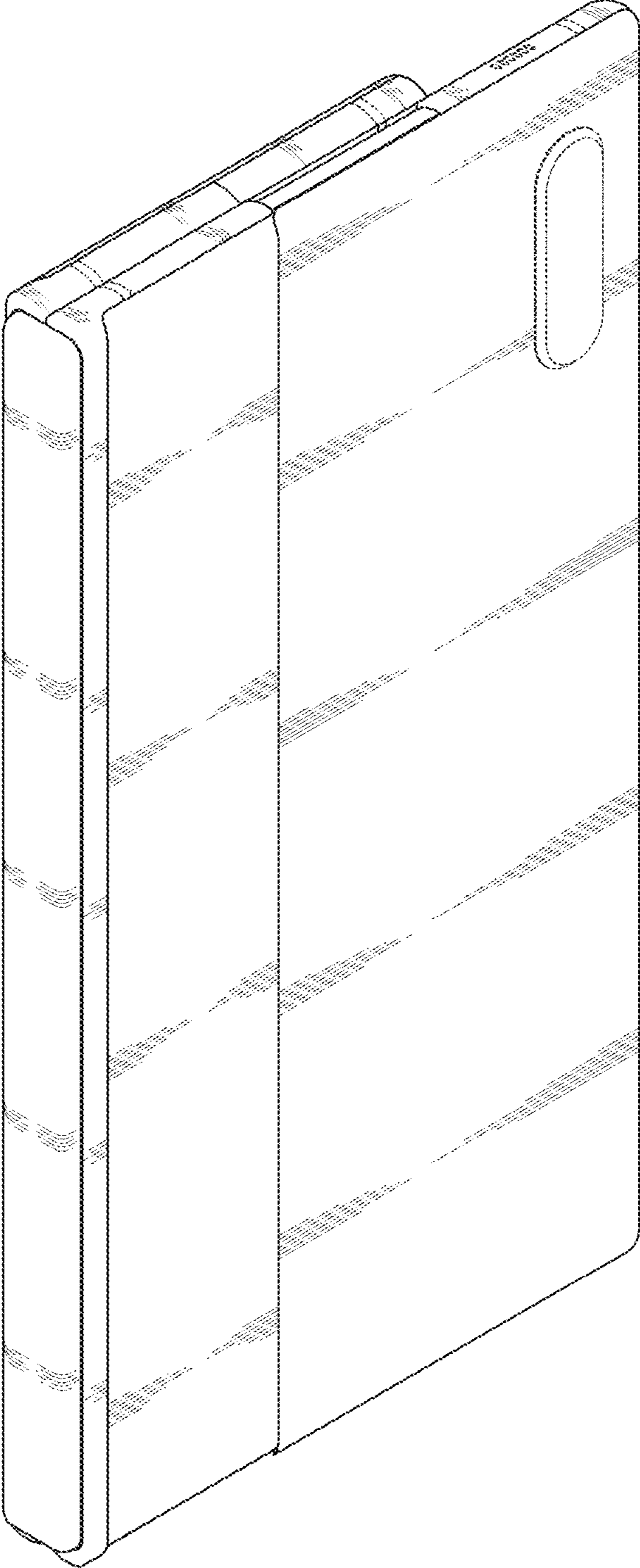

FIG. 23

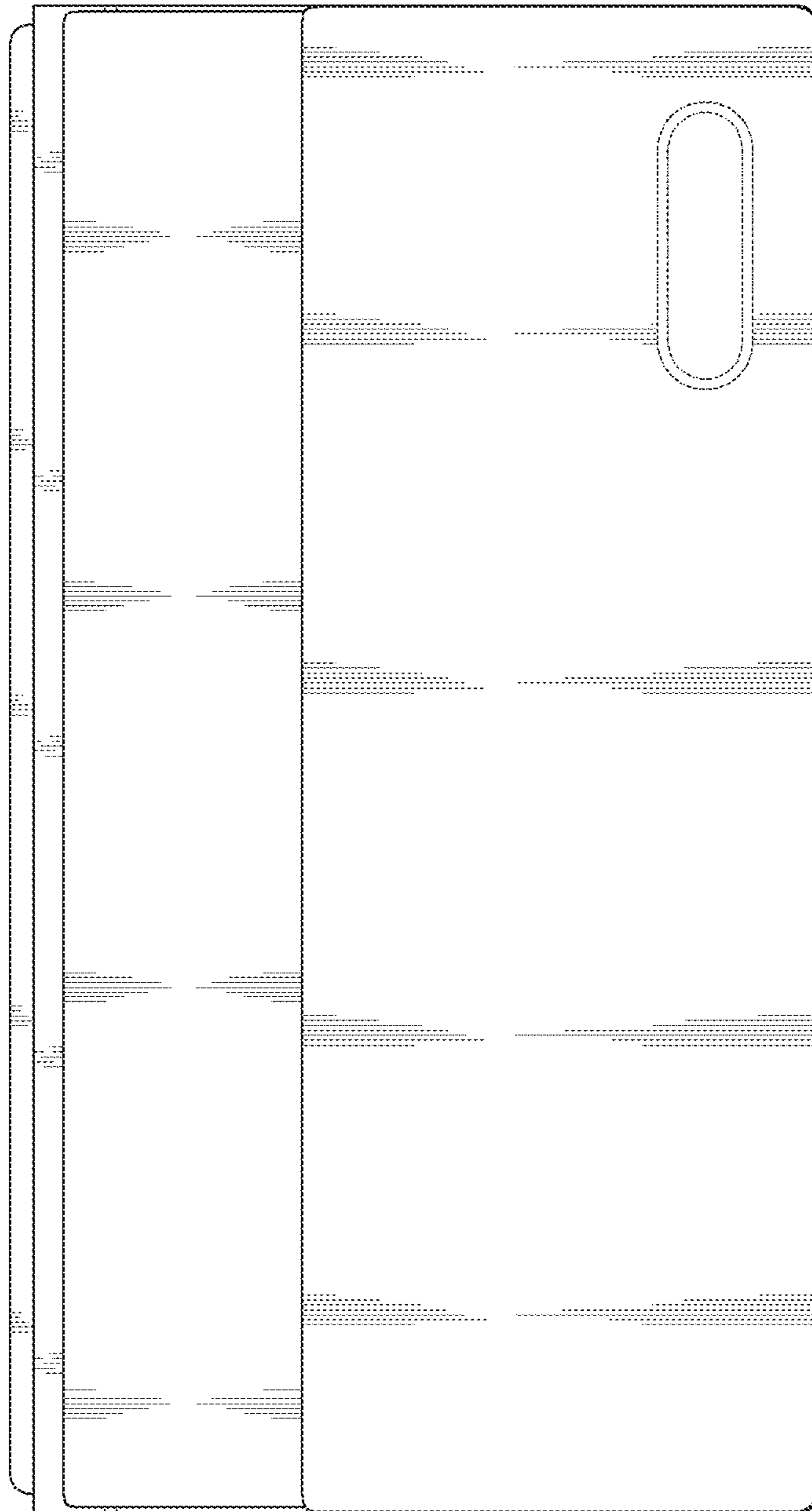

FIG. 24

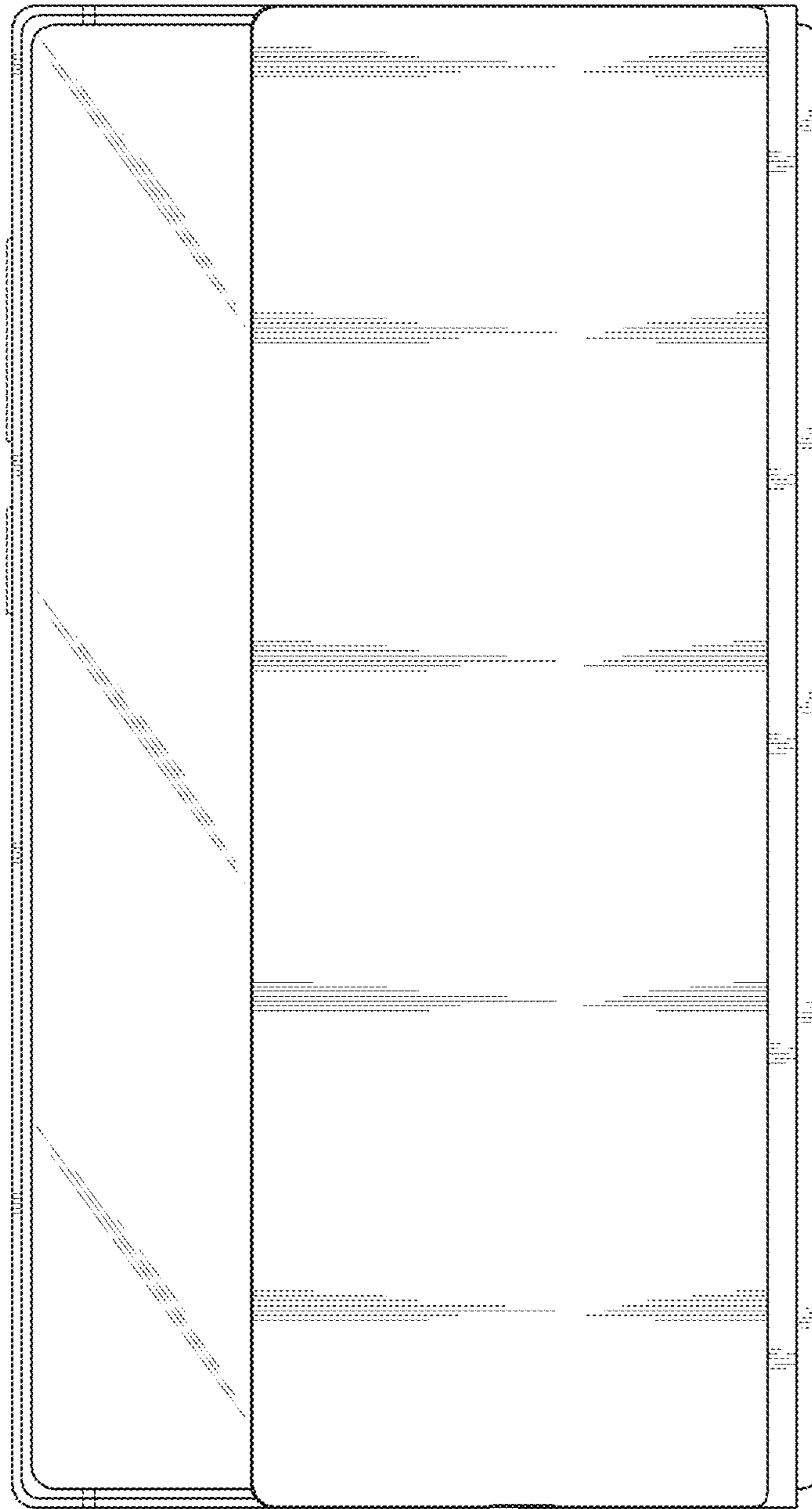

FIG. 25

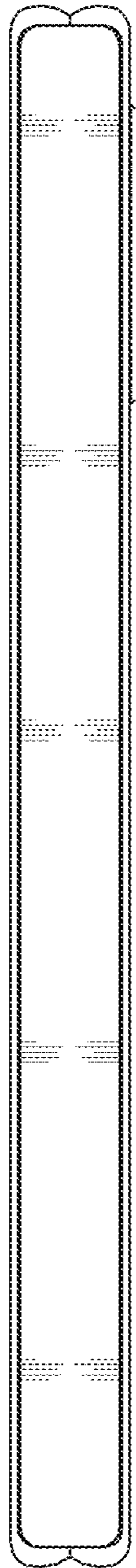

FIG. 26

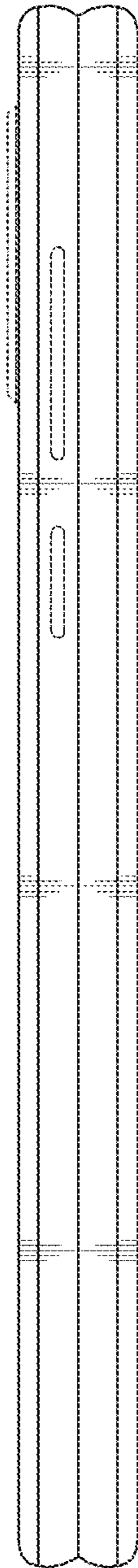

FIG. 27

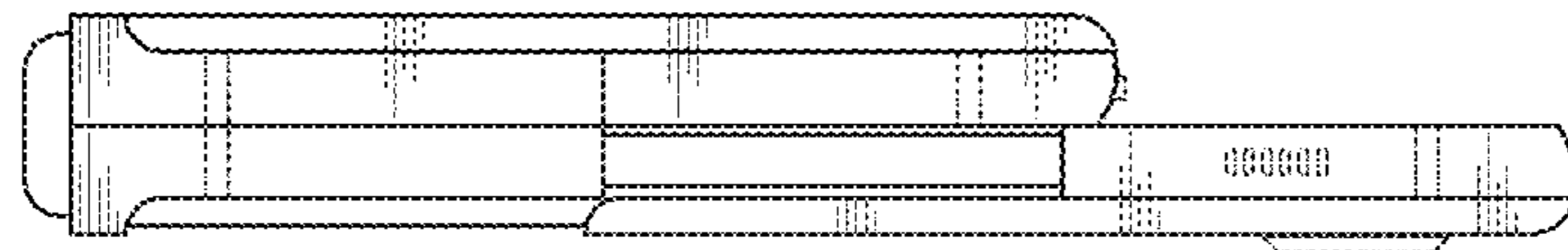

FIG. 28

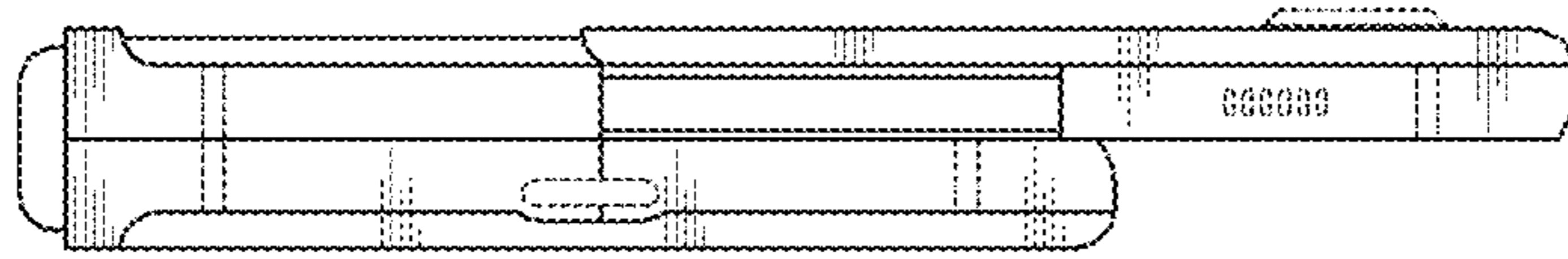

FIG. 29

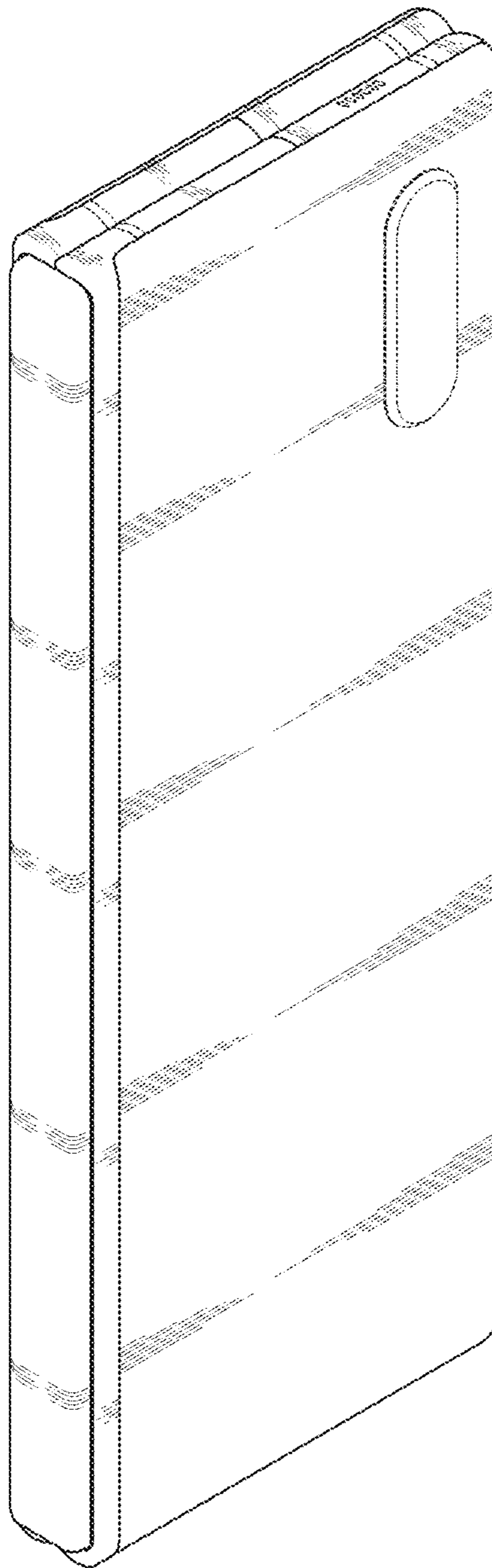

FIG. 30

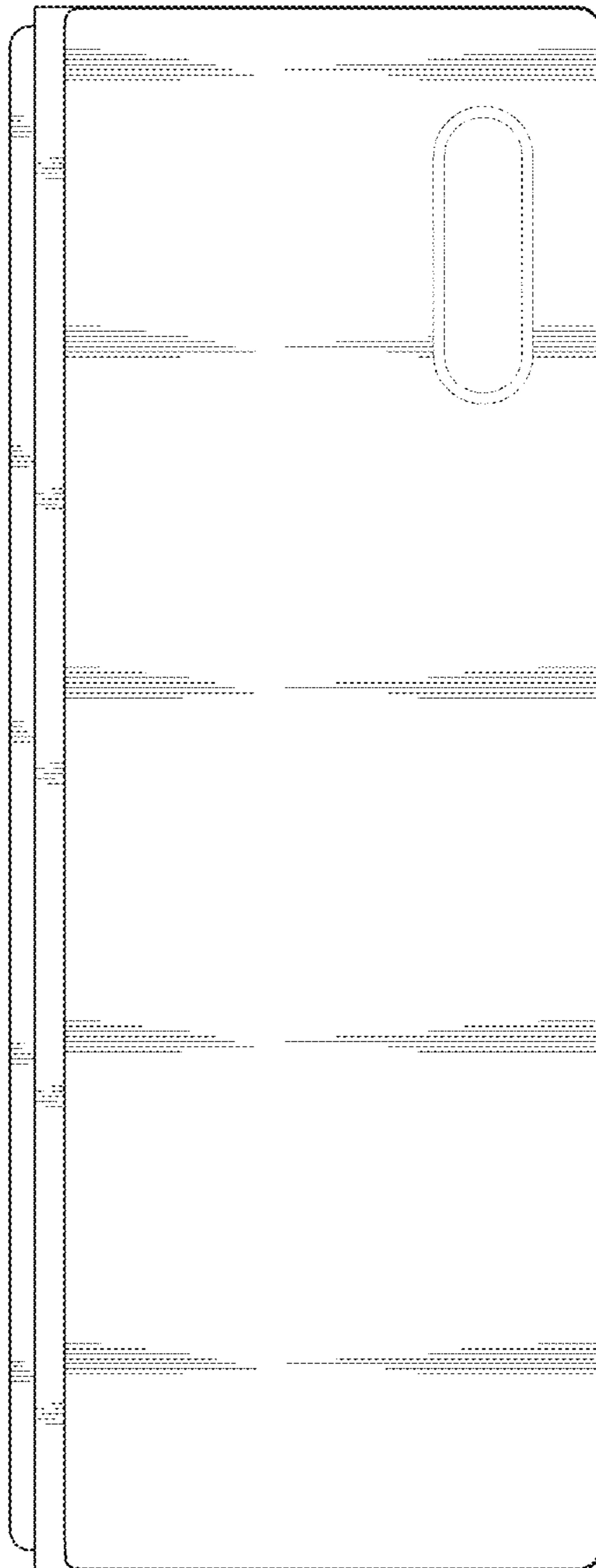

FIG. 31

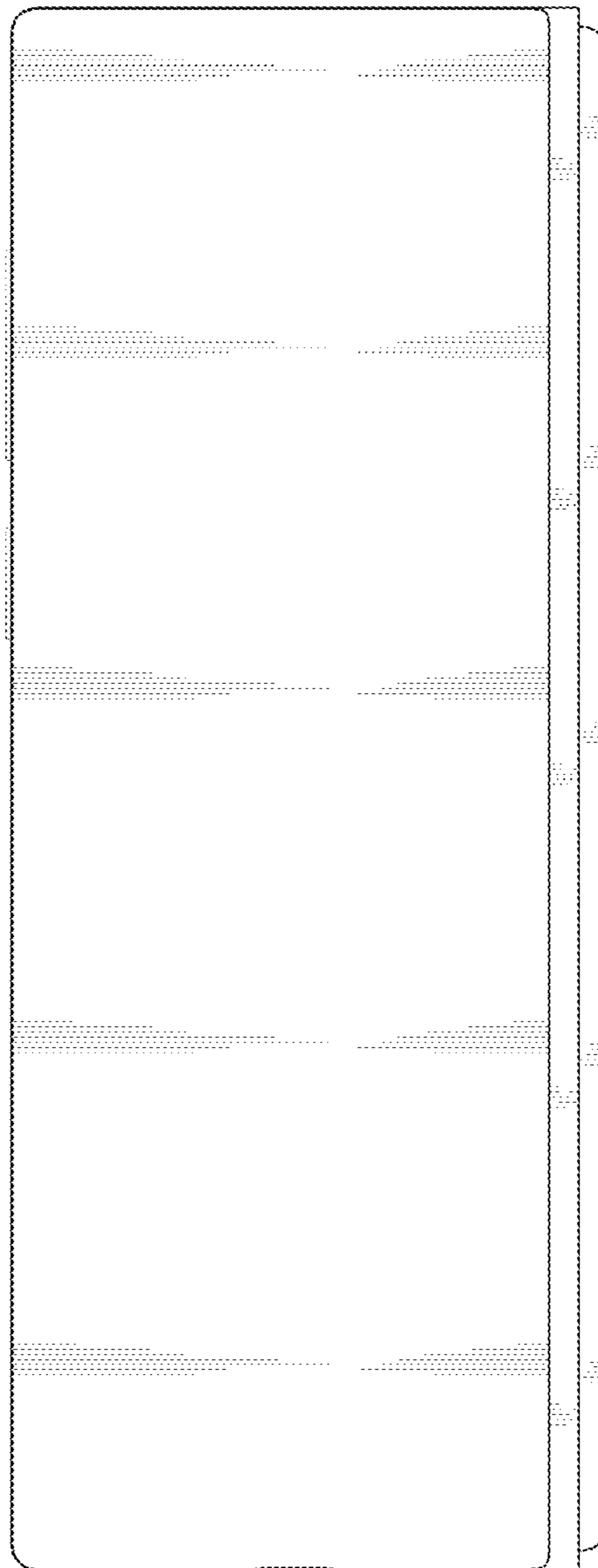

FIG. 32

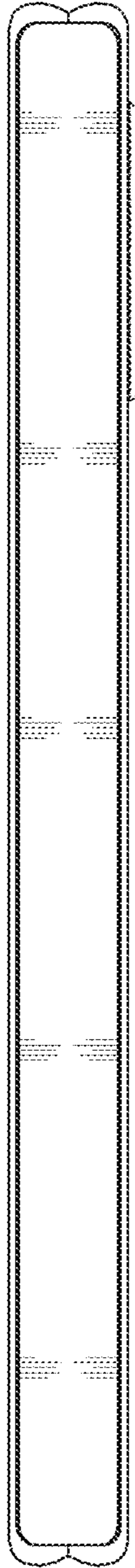

FIG. 33

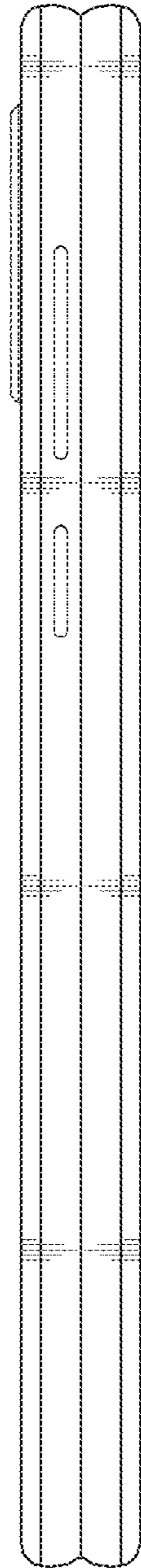

FIG. 34

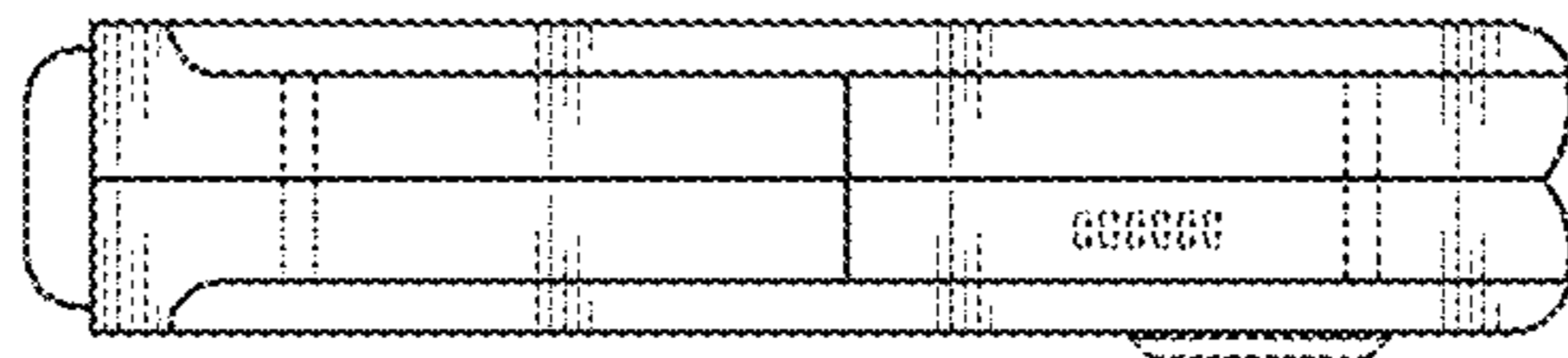

FIG. 35

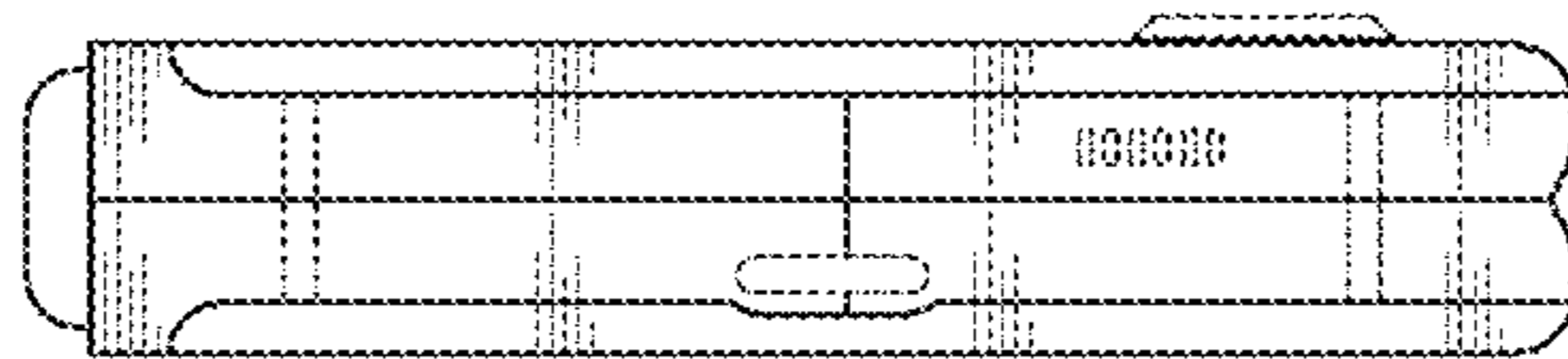

FIG. 36

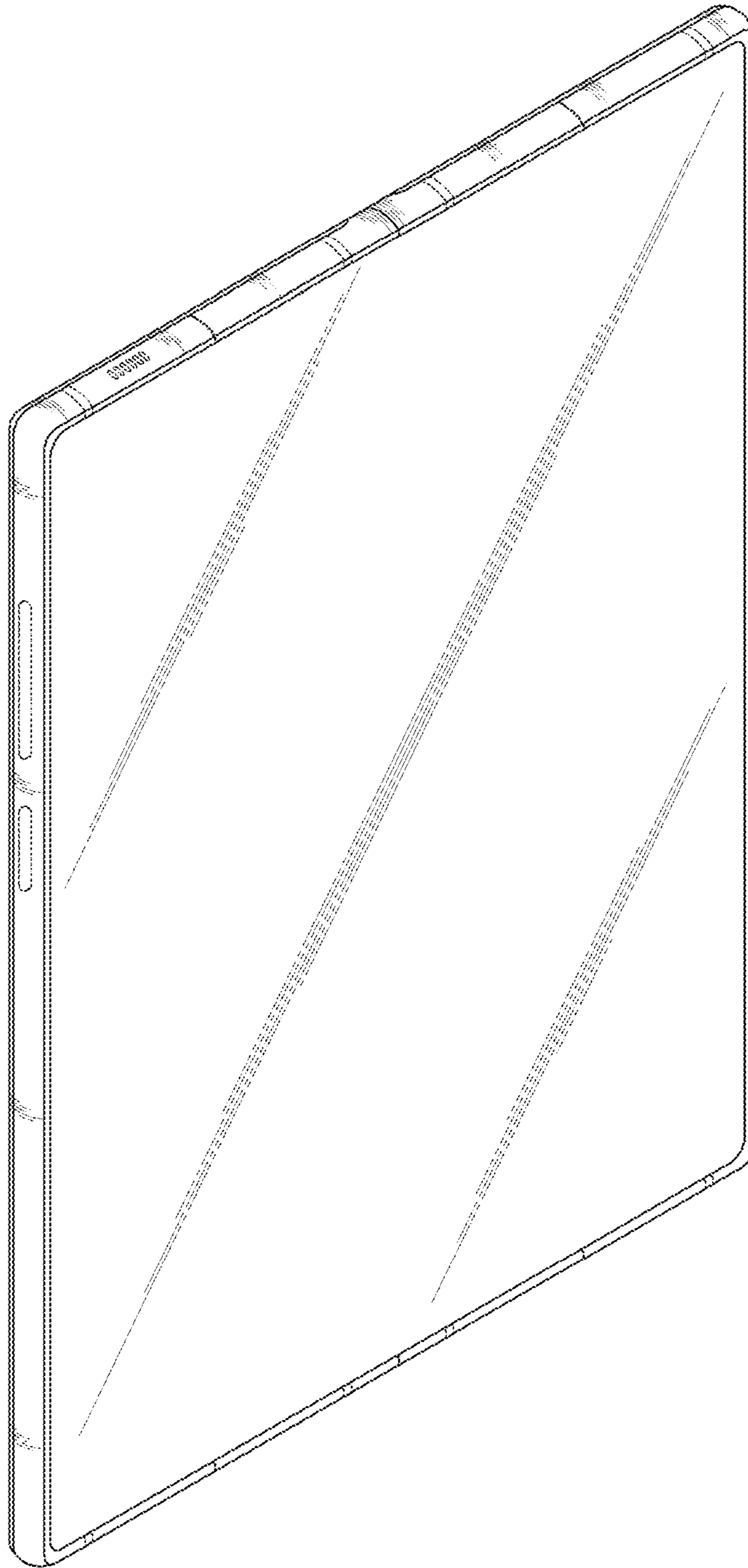

FIG. 37

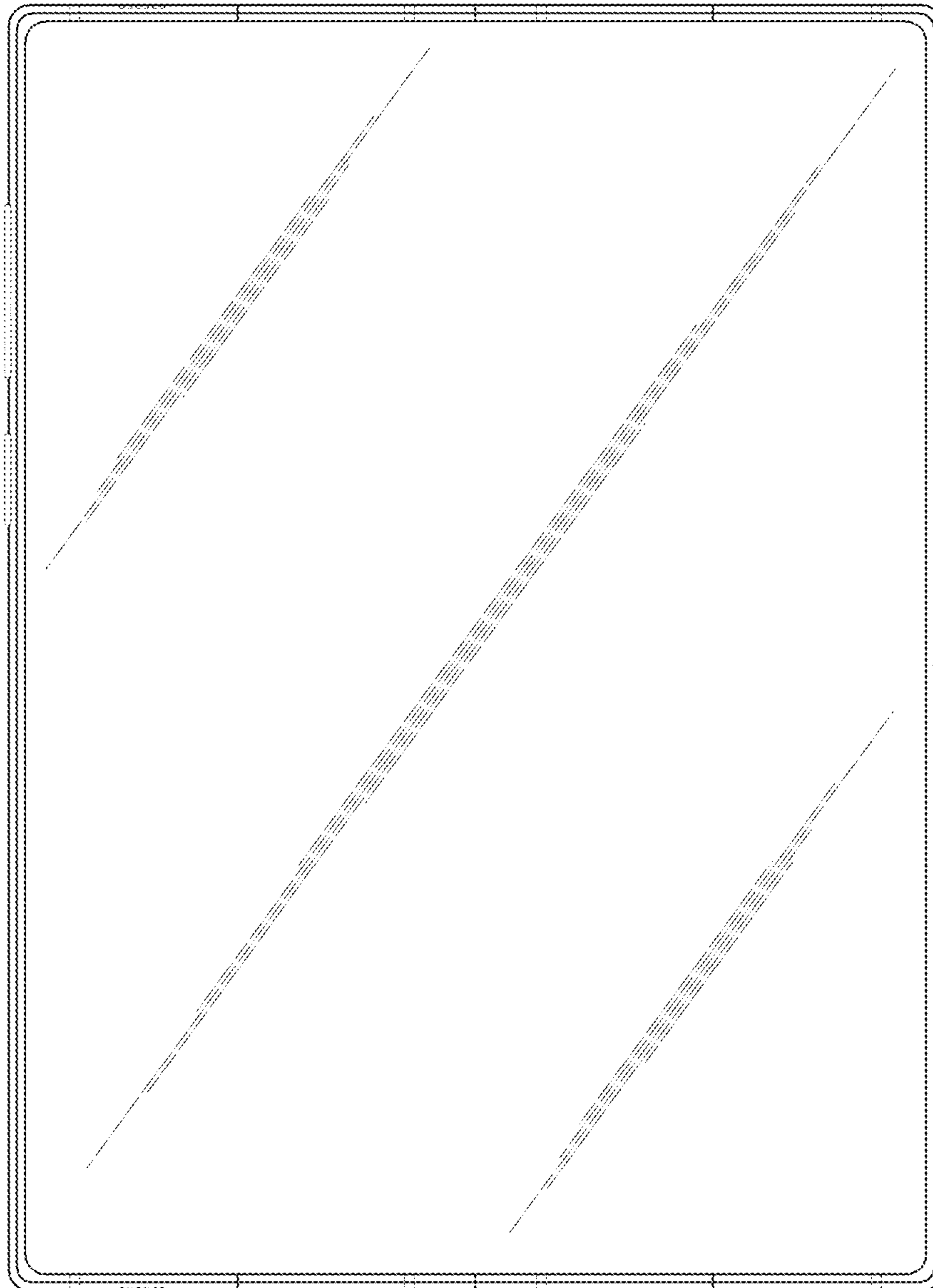

FIG. 38

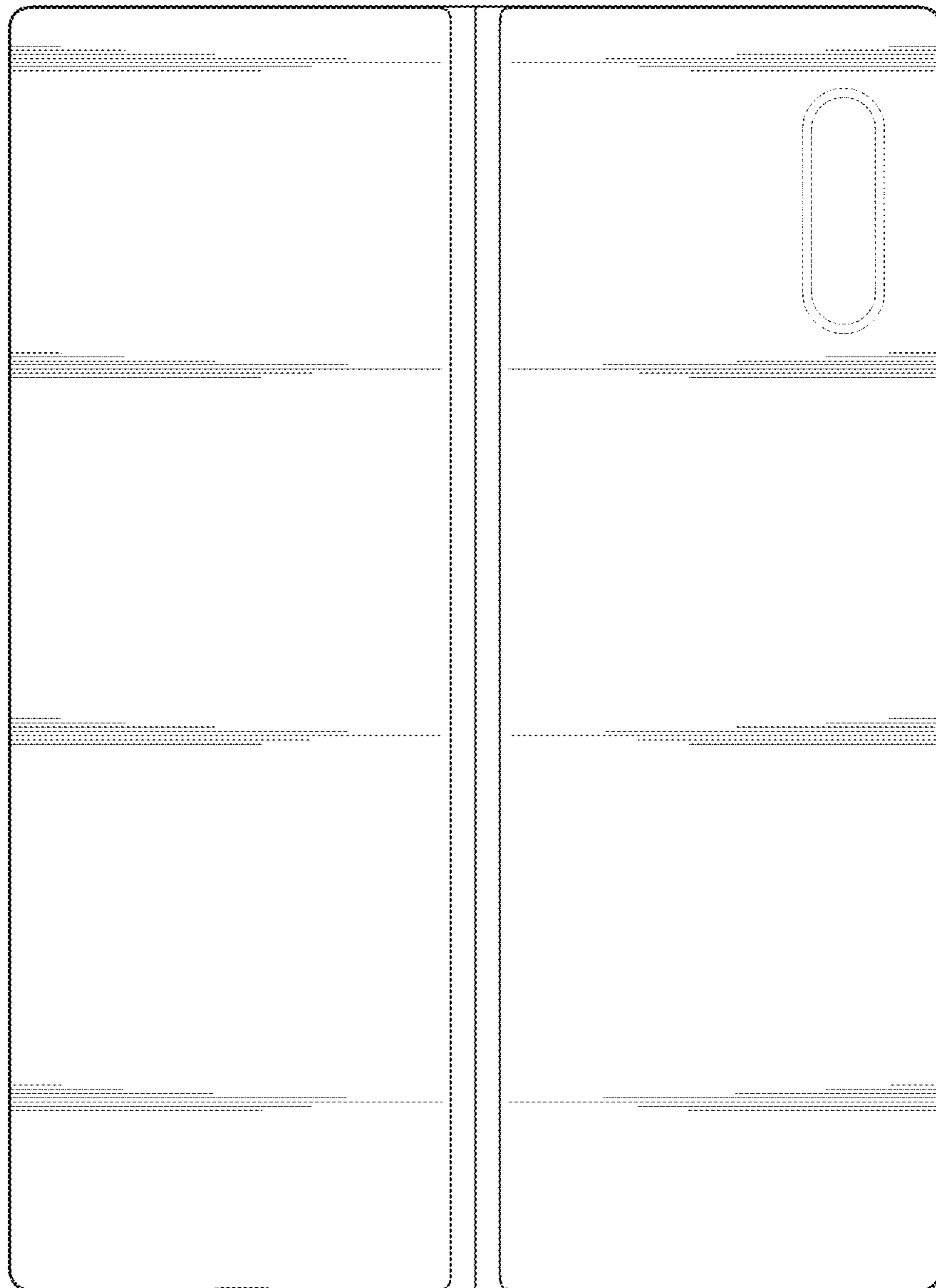

FIG. 39

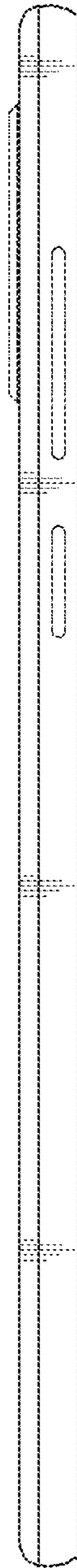

FIG. 40

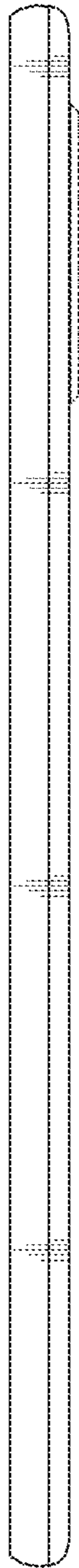

FIG. 41



FIG. 42

