



US00D971161S

(12) **United States Design Patent**
Liu

(10) **Patent No.:** **US D971,161 S**

(45) **Date of Patent:** **** Nov. 29, 2022**

(54) **CHARGING CABLE**

(71) Applicant: **SHENZHEN SHANQIRUI TECHNOLOGY CO., LTD**, Shenzhen (CN)

(72) Inventor: **Donggen Liu**, Fengcheng (CN)

(**) Term: **15 Years**

(21) Appl. No.: **29/824,572**

(22) Filed: **Jan. 26, 2022**

(51) **LOC (13) Cl.** **13-03**

(52) **U.S. Cl.**
USPC **D13/153**

(58) **Field of Classification Search**
USPC D13/153, 147, 133, 137.1-137.4, 107, D13/108, 162; D14/433, 218, 205, 496
CPC A61B 18/14; H01R 31/02; G02B 6/3878
See application file for complete search history.

(56) **References Cited**

U.S. PATENT DOCUMENTS

D819,576 S	6/2018	Hahn	
D896,762 S *	9/2020	Hu	D13/147
D900,754 S *	11/2020	Fu	D13/153
D900,789 S *	11/2020	Chen	D14/218
D901,505 S *	11/2020	Chen	D13/133
D901,506 S *	11/2020	He	D13/133
D906,257 S *	12/2020	Cai	D13/153
D915,297 S *	4/2021	Nauroy	D13/153
D924,841 S *	7/2021	Yuan	D14/205
D925,458 S *	7/2021	Chen	D13/137.2
D925,464 S *	7/2021	Seo	D13/153
D928,727 S *	8/2021	Chen	D13/162
D931,819 S *	9/2021	Wan	D13/147
D935,420 S *	11/2021	Cai	D13/153
D937,215 S *	11/2021	Garrett	D13/133
D946,052 S *	3/2022	Olsson	D14/496
D946,506 S *	3/2022	Cheng	D13/107
D946,508 S *	3/2022	Cheng	D13/107

D953,276 S *	5/2022	Chen	D13/153
D956,697 S *	7/2022	Zhang	D13/147
D956,698 S *	7/2022	Zhang	D13/147
D958,065 S *	7/2022	Kaneda	D13/107
D958,071 S *	7/2022	Yang	D13/108
D958,072 S *	7/2022	Yang	D13/108
D960,164 S *	8/2022	Yang	D14/433
D960,165 S *	8/2022	Yang	D14/433

* cited by examiner

Primary Examiner — Rhea Shields

(57) **CLAIM**

The ornamental design for a charging cable, as shown and described.

DESCRIPTION

FIG. 1 is a front and top perspective view of a charging cable, showing my new design;
 FIG. 2 is a rear and bottom perspective view thereof;
 FIG. 3 is a front elevation view thereof;
 FIG. 4 is a rear elevation view thereof;
 FIG. 5 is a top plan view thereof;
 FIG. 6 is a bottom plan view thereof;
 FIG. 7 is a left side elevation view thereof;
 FIG. 8 is a right side elevation view thereof;
 FIG. 9 is an enlarged view of a portion labeled, 'FIG. 9' in FIG. 1;
 FIG. 10 is an enlarged view of a portion labeled, 'FIG. 10' in FIG. 1;
 FIG. 11 is an enlarged view of a portion labeled, 'FIG. 11' in FIG. 2; and,
 FIG. 12 is an enlarged view of a portion labeled, 'FIG. 12' in FIG. 2.

The broken lines, in the figures illustrate portions of the charging cable that form no part of the claimed design. The dash dot dash lines in FIGS. 1, 2, 9, 10, 11 and 12 are for the purpose of depicting the boundary lines of the enlarged views and form no part of the claimed design.

1 Claim, 12 Drawing Sheets

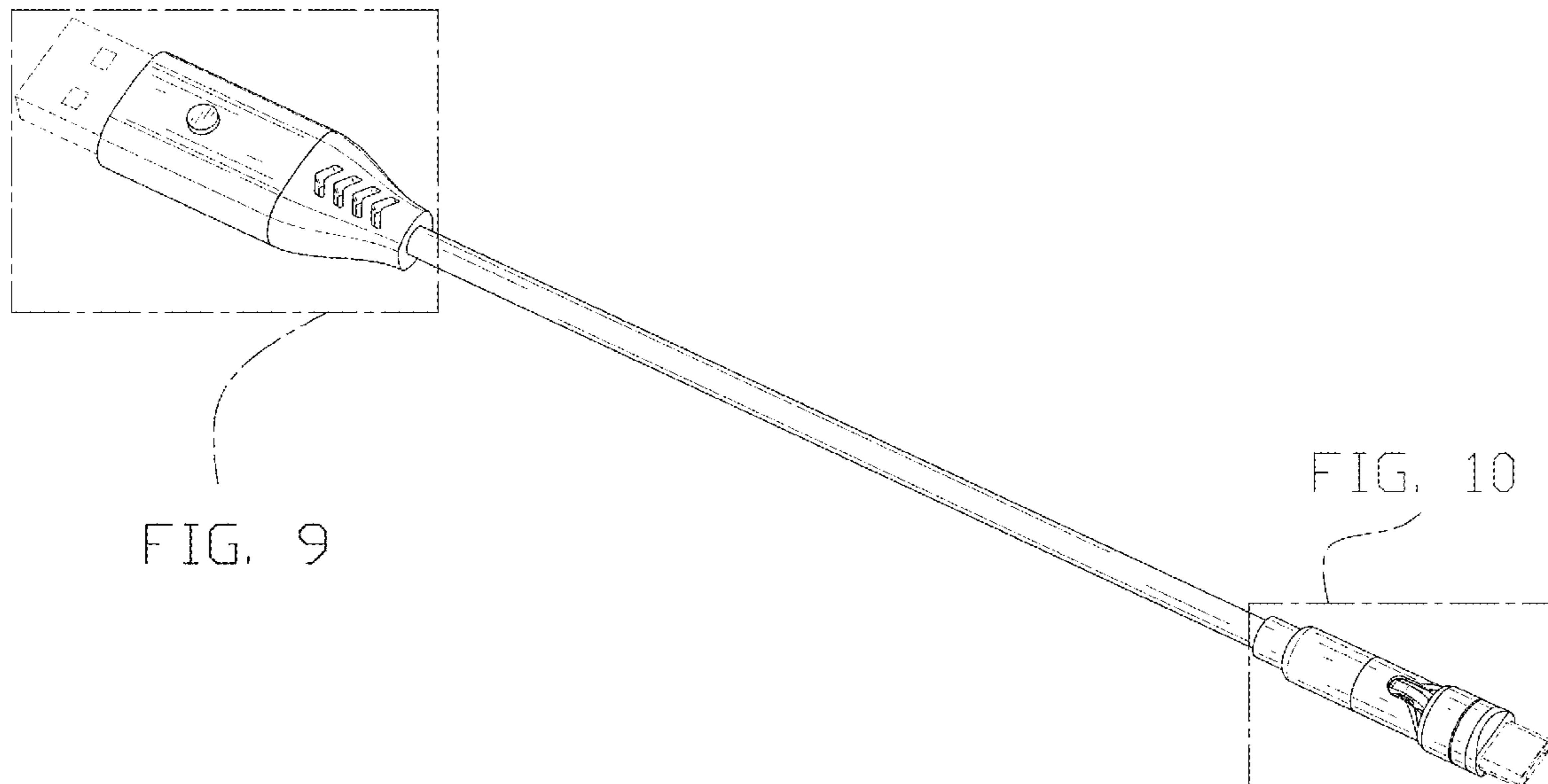

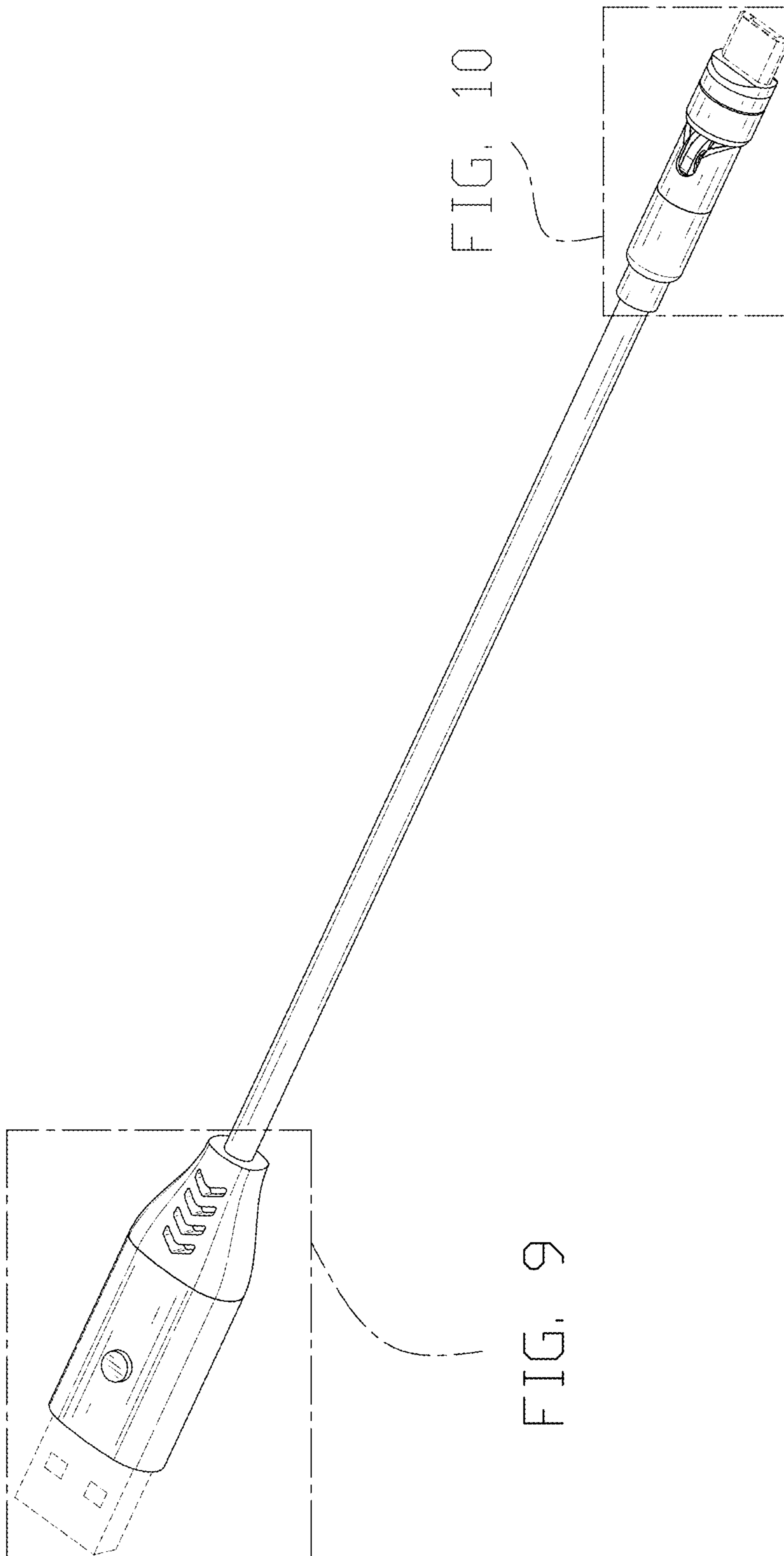
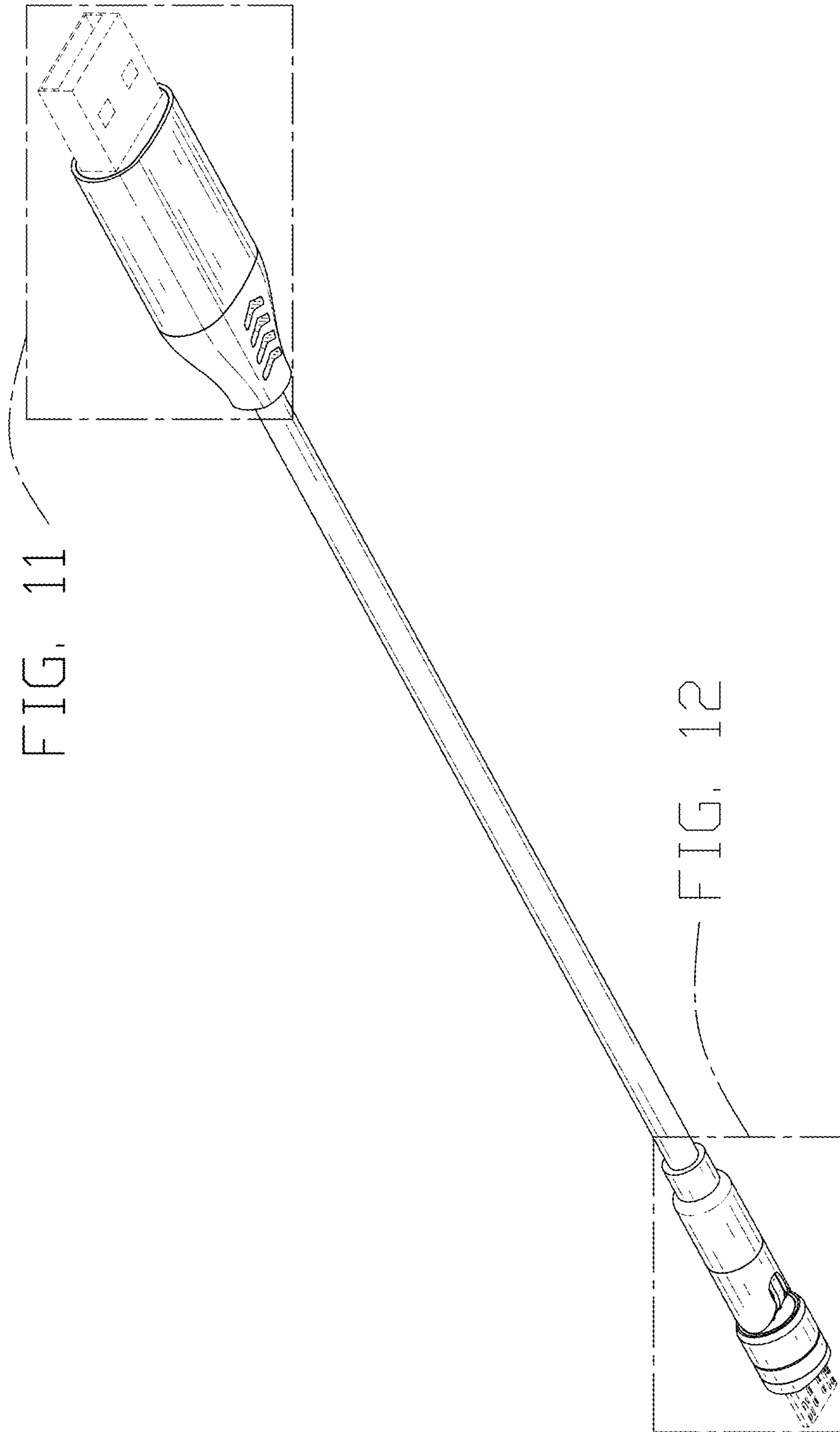

FIG. 1



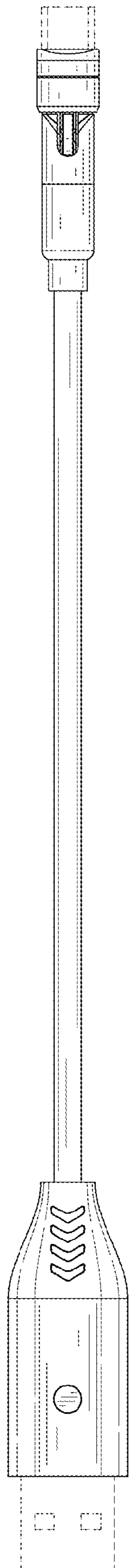

FIG. 3

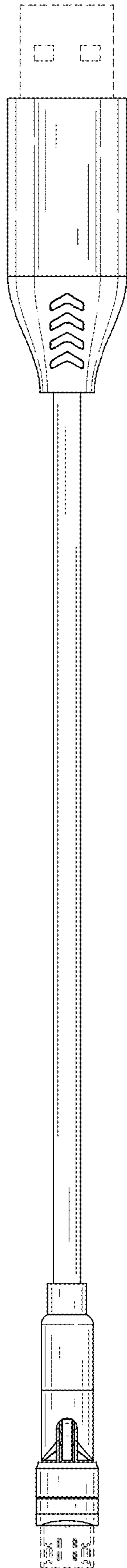

FIG. 4

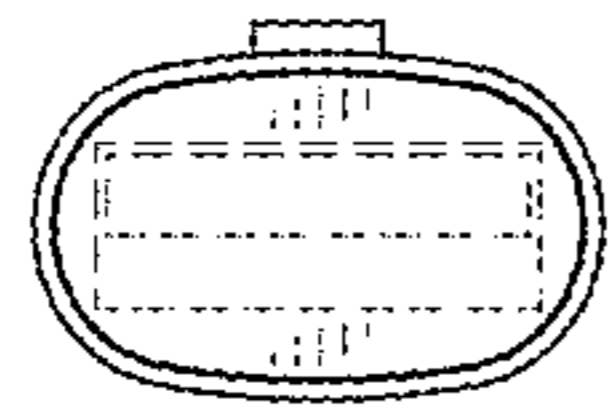

FIG. 5

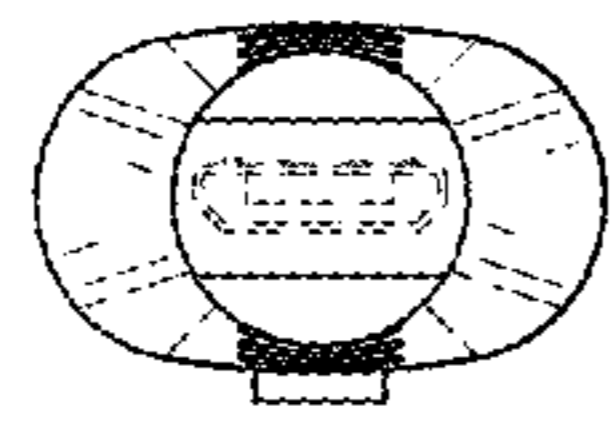

FIG. 6

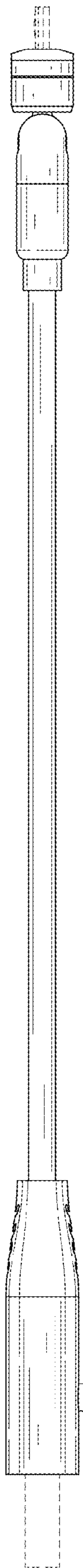

FIG. 7

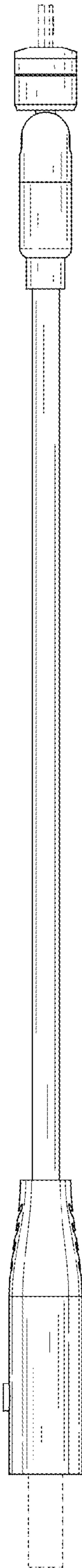

FIG. 8

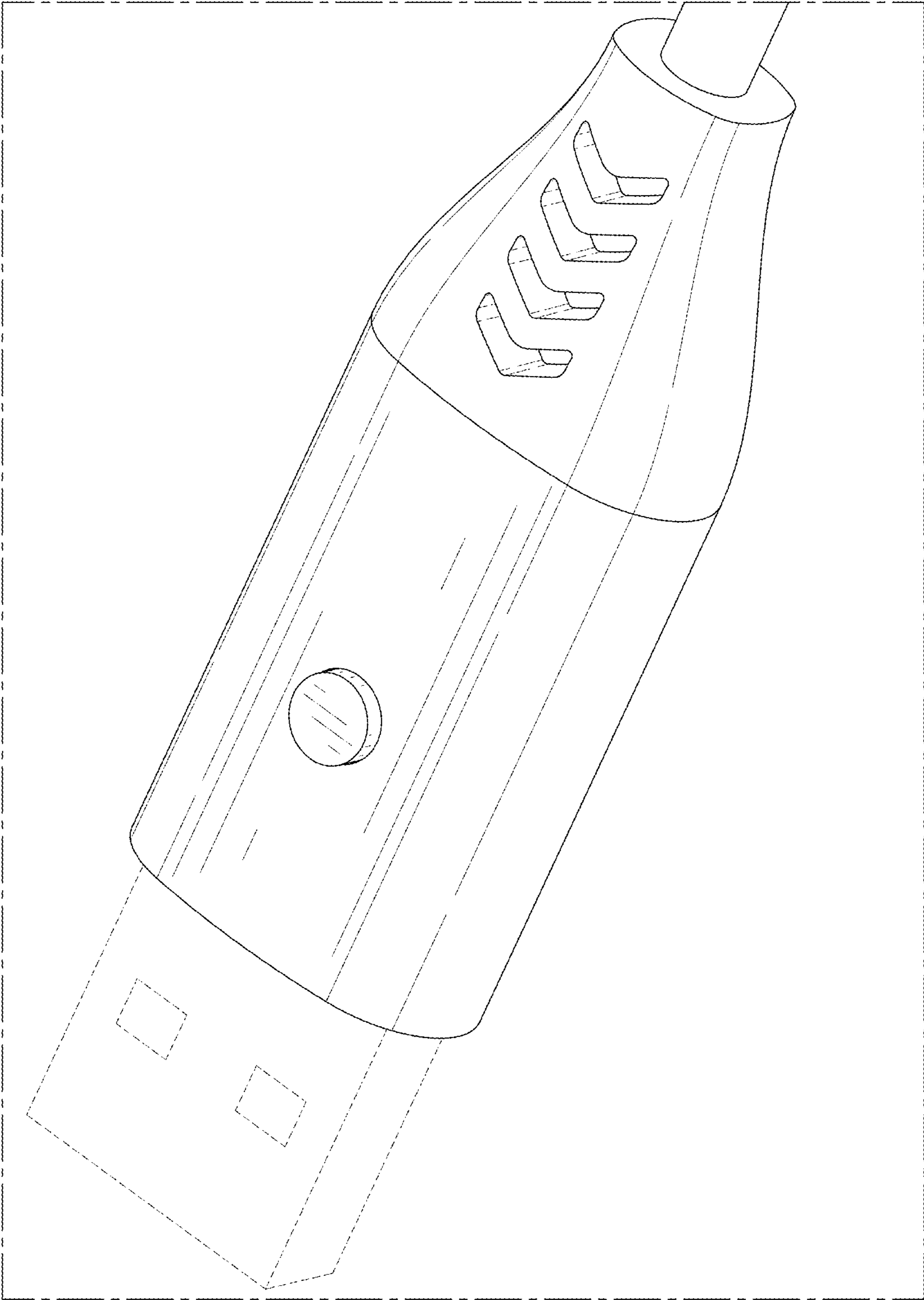

FIG. 9

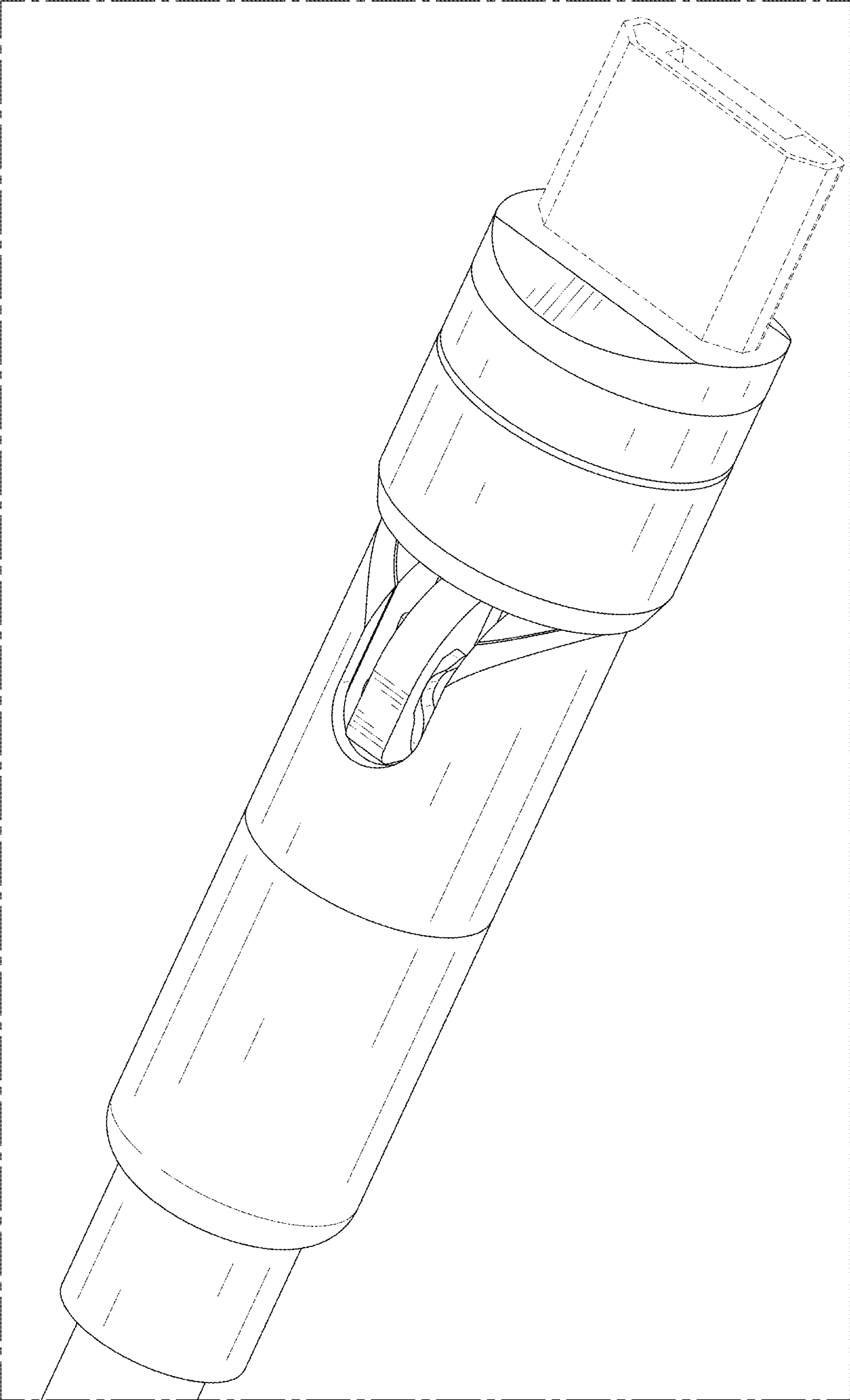

FIG. 10

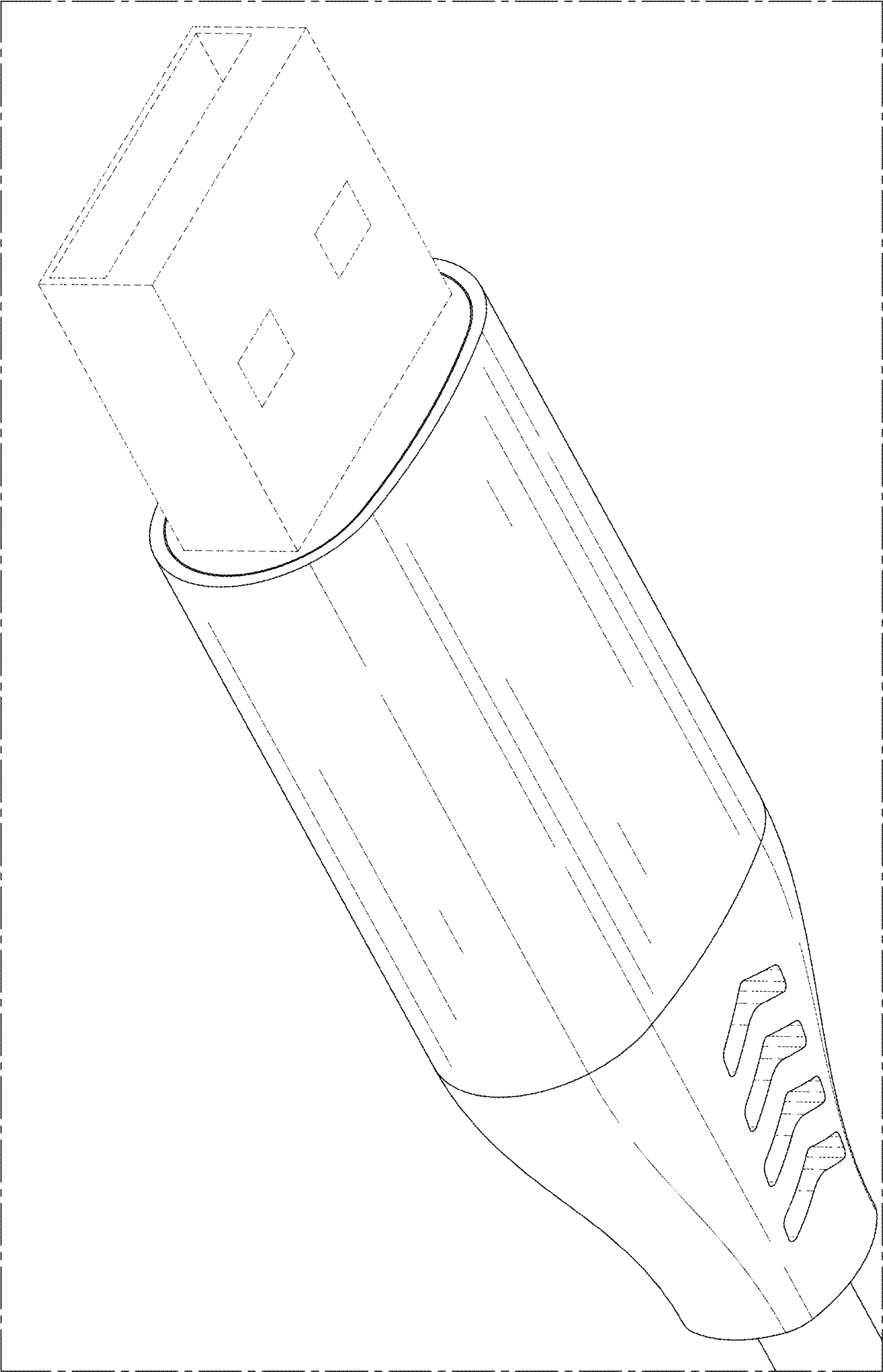

FIG. 11

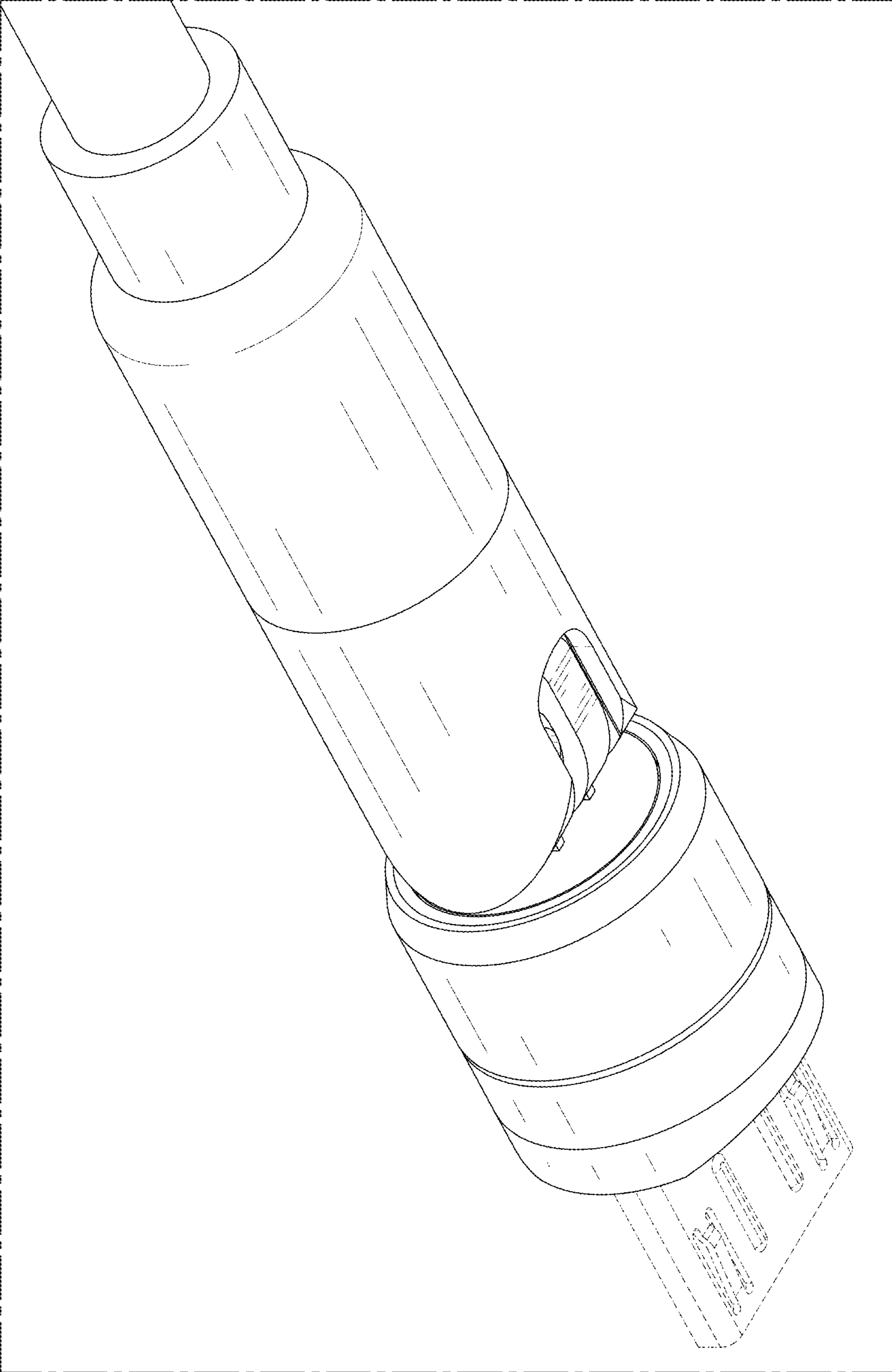

FIG. 12