



US00D971157S

(12) **United States Design Patent** (10) **Patent No.:** **US D971,157 S**  
**Fu** (45) **Date of Patent:** **\*\* Nov. 29, 2022**

- (54) **SOCKET**
- (71) Applicant: **SCHNEIDER ELECTRIC (AUSTRALIA) PTY LTD**, Macquarie Park (AU)
- (72) Inventor: **Jiayu Fu**, Shenzhen (CN)
- (73) Assignee: **Schneider Electric (Australia) PTY LTD**, Macquarie Park (AU)
- (\*\*) Term: **15 Years**
- (21) Appl. No.: **29/805,743**
- (22) Filed: **Aug. 30, 2021**

**Related U.S. Application Data**

- (62) Division of application No. 29/703,888, filed on Aug. 30, 2019.
- (51) **LOC (13) Cl.** ..... **13-03**
- (52) **U.S. Cl.**  
USPC ..... **D13/139.1**
- (58) **Field of Classification Search**  
USPC ..... D13/137.1-137.4, 138.1, 138.2, D13/139.1-139.8, 171, 173, 174, 178, D13/184, 110  
CPC .. H01R 13/639; H01R 13/6392; H01R 13/64; H01R 13/642; H01R 13/648; H01R 13/652; H01R 13/66; H01R 13/6666; H01R 13/6683; H01R 13/68; H01R 13/713; H01R 25/00; H01R 25/003; H01R 25/006; H01R 2103/00; H01R 24/20; H01R 24/22; H01R 24/28; H01R 24/30; H02G 3/12; H02G 3/14; H01H 73/06; H01H 73/08; H01H 71/58; H01H 83/04

See application file for complete search history.

(56) **References Cited**

**U.S. PATENT DOCUMENTS**

- D329,422 S 9/1992 Fujiyoshi
- 6,160,219 A 12/2000 Maltby et al.

6,215,066 B1 4/2001 Kelso et al.  
D512,377 S \* 12/2005 Fort ..... D13/139.3  
(Continued)

**OTHER PUBLICATIONS**

10 Pack Outlet Socket, Decora Duplex Receptacle 15Amp. Ebay. Posted by micmi-com. Posting date: Dec. 2, 2020. Retrieval date: Jun. 23, 2021. Retrieved from internet: <https://www.ebay.com/itm/284100970031> (Year: 2020).

(Continued)

*Primary Examiner* — Mary Shannon Malley  
*Assistant Examiner* — Lee D. Starr  
(74) *Attorney, Agent, or Firm* — Locke Lord LLP

(57) **CLAIM**

The ornamental design for a socket, as shown and described.

**DESCRIPTION**

FIG. 1 is a front view of the socket, showing my new design. FIG. 2 is a back view thereof. FIG. 3 is a bottom view thereof. FIG. 4 is a top view thereof. FIG. 5 is a left side elevational view thereof. FIG. 6 is a right side elevational view thereof. FIG. 7 is a back perspective view thereof; and, FIG. 8 is a front perspective view thereof. The masked areas adjacent to the dash-dot broken lines in the drawings depict portions of the socket that form no part of the claimed design. The dash-dot broken lines define the bounds of the claimed design and form no part thereof. The masked areas adjacent to the broken lines in the drawings form no part of the claimed design. The dash-dot broken lines define the bounds of the claimed design and form no part thereof.

**1 Claim, 4 Drawing Sheets**

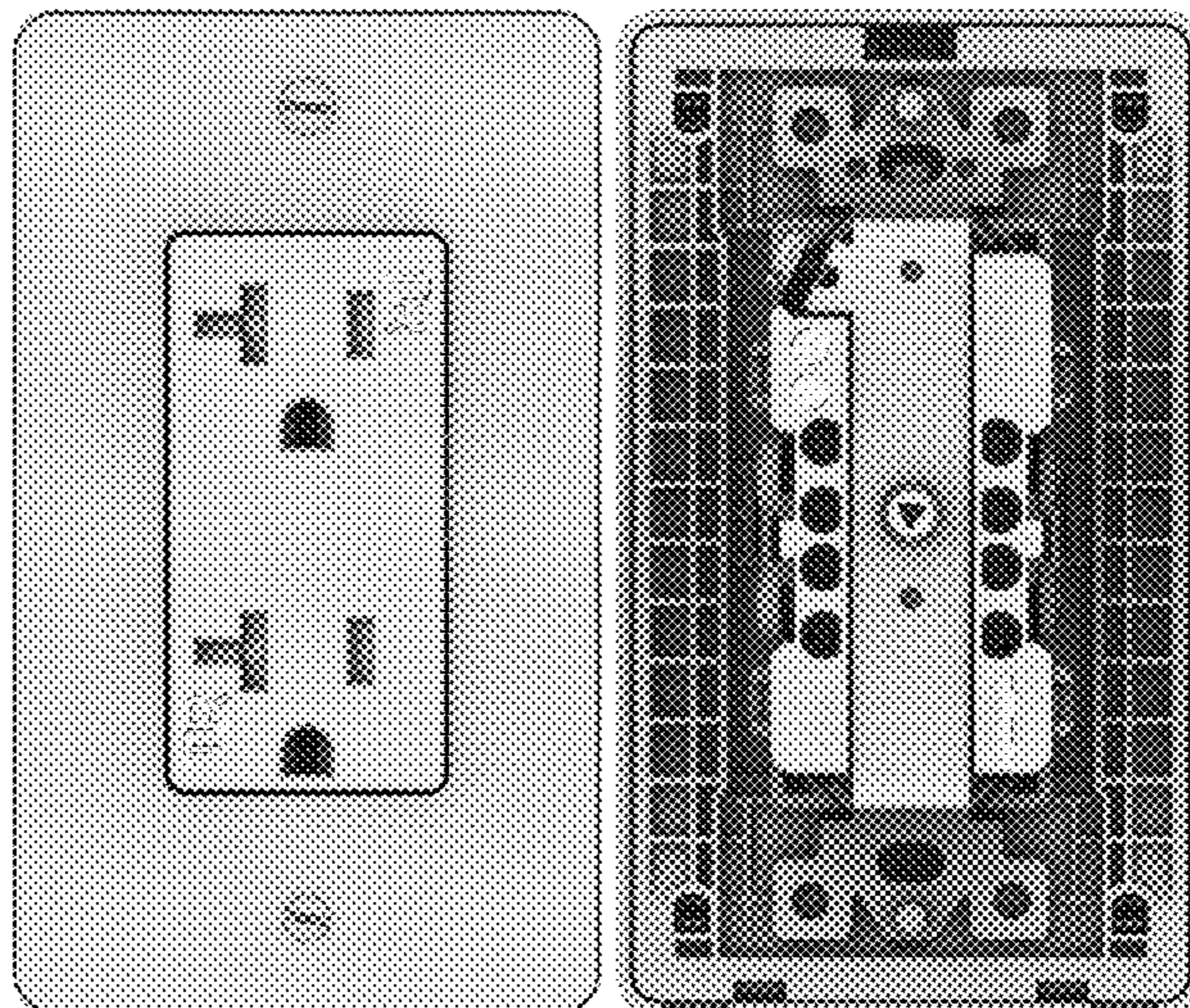

(56)

**References Cited**

U.S. PATENT DOCUMENTS

D558,676 S 1/2008 Fort et al.  
 D571,729 S \* 6/2008 Kidman ..... D13/139.3  
 RE40,600 E 12/2008 Maltby et al.  
 8,029,301 B2 10/2011 Kidman  
 D711,828 S 8/2014 Mozdzer  
 9,379,474 B1 \* 6/2016 McGowan, Jr. ... H01R 13/4534  
 9,666,975 B1 \* 5/2017 Baldwin ..... H02G 3/088  
 D804,429 S \* 12/2017 Baldwin ..... D8/353  
 D826,860 S \* 8/2018 Iaconis ..... D13/139.1  
 D851,602 S 6/2019 Chen  
 D912,627 S 3/2021 Stephens  
 D945,370 S \* 3/2022 Chen ..... D13/139.1  
 2014/0246218 A1 \* 9/2014 Shotey ..... H01R 25/006  
 174/66  
 2016/0315408 A1 10/2016 Levine  
 2018/0375313 A1 \* 12/2018 Misener ..... H02G 3/18

2019/0229478 A1 \* 7/2019 Iaconis ..... H01R 13/701  
 2021/0313787 A1 10/2021 Misener et al.

OTHER PUBLICATIONS

Outlet Socket, Decora Duplex Receptacle, 20 Amp 125 Volt Tamper Resistant. Ebay. Posted by micmi-com. Posting date: Dec. 2, 2020. Retrieval date: Jun. 23, 2021. Retrieved from internet: <<https://www.ebay.com/itm/284101013240>> (Year: 2020).  
 (20 Pack) CML 15 Amp Decor Receptacle Outlet with Screwless Wallplate. Ebay. Posted by nufistore. Posting date: Jun. 7, 2021. Retrieval date: Jun. 23, 2021. Retrieved from internet: <<https://www.ebay.com/itm/284323552737>> (Year: 2021).  
 BESTTEN 20A Wall Receptacle Outlet, Tamper-Resistant. Amazon. Oldest review date: Sep. 3, 2020. Retrieval date: Mar. 23, 2022. Retrieved from internet: <https://www.amazon.com/dp/B07WGCKX1F> (Year: 2020).

\* cited by examiner

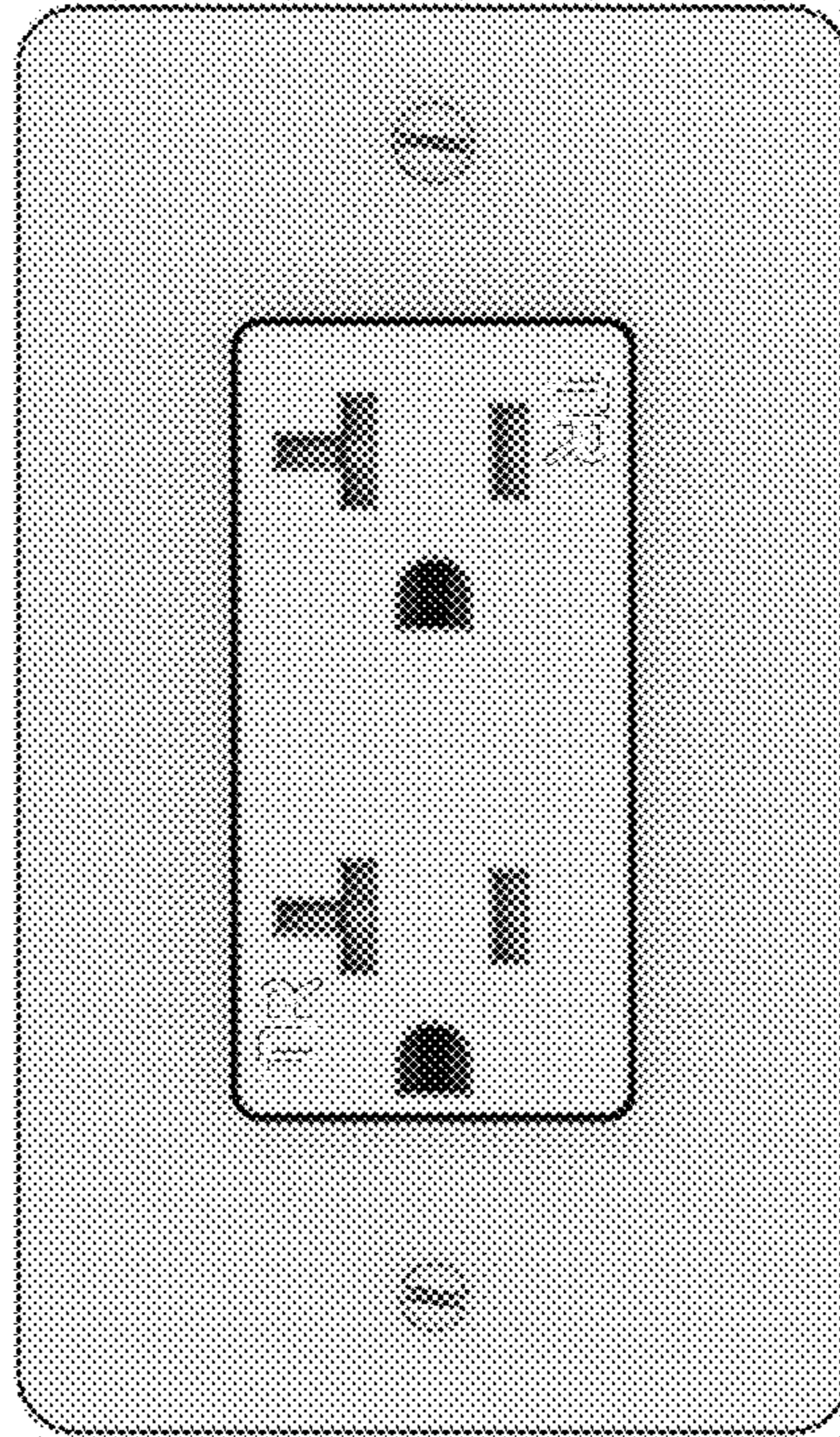

**FIG. 1**

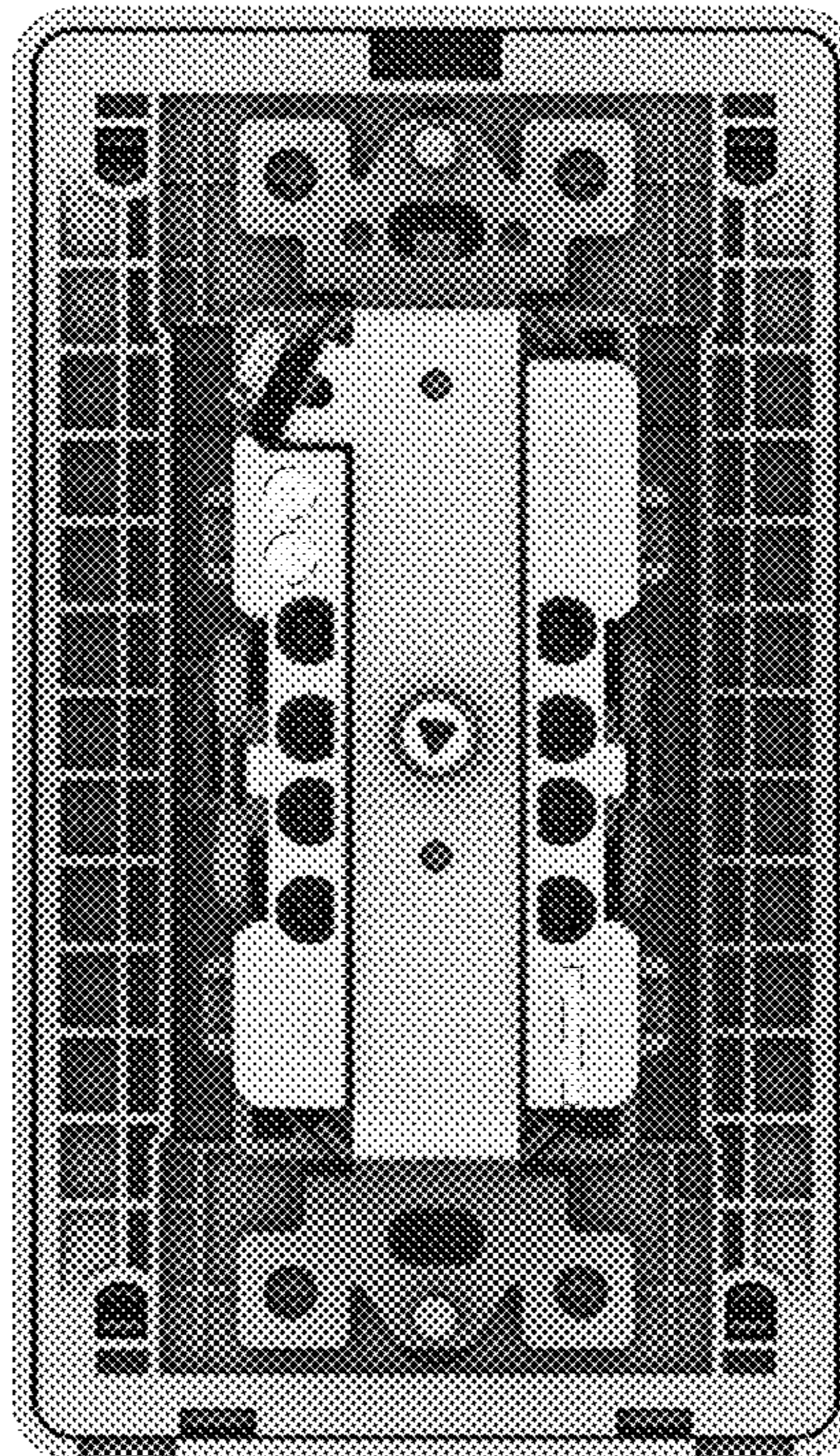

**FIG. 2**

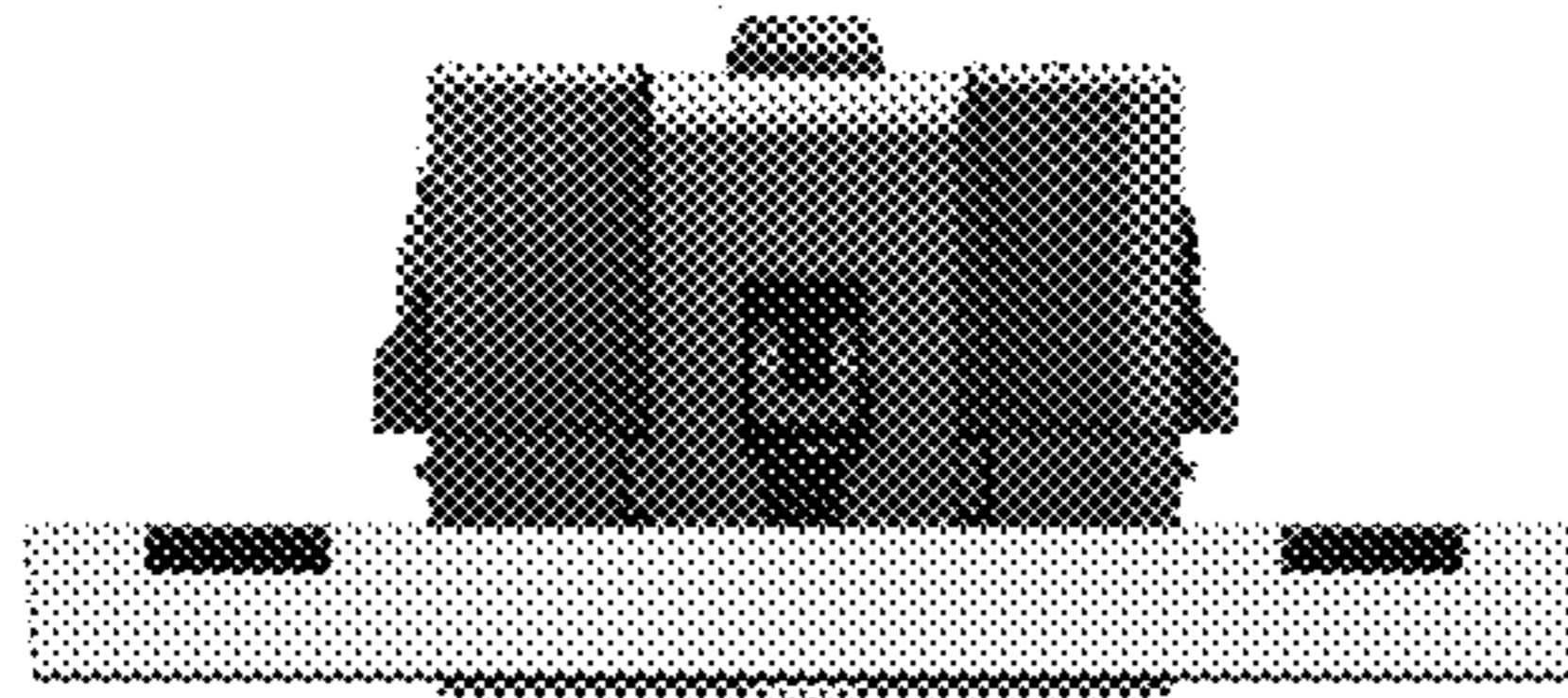

**FIG. 3**

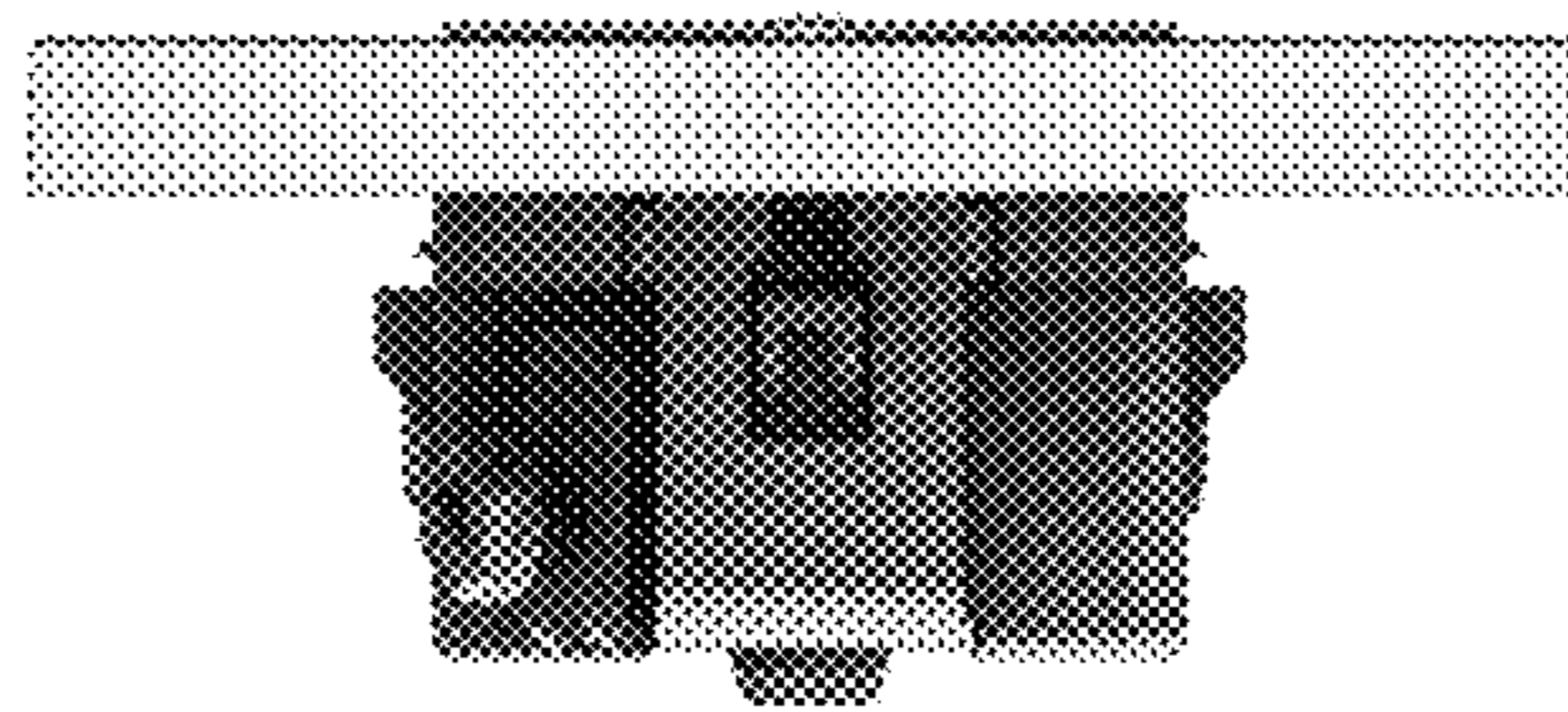

**FIG. 4**

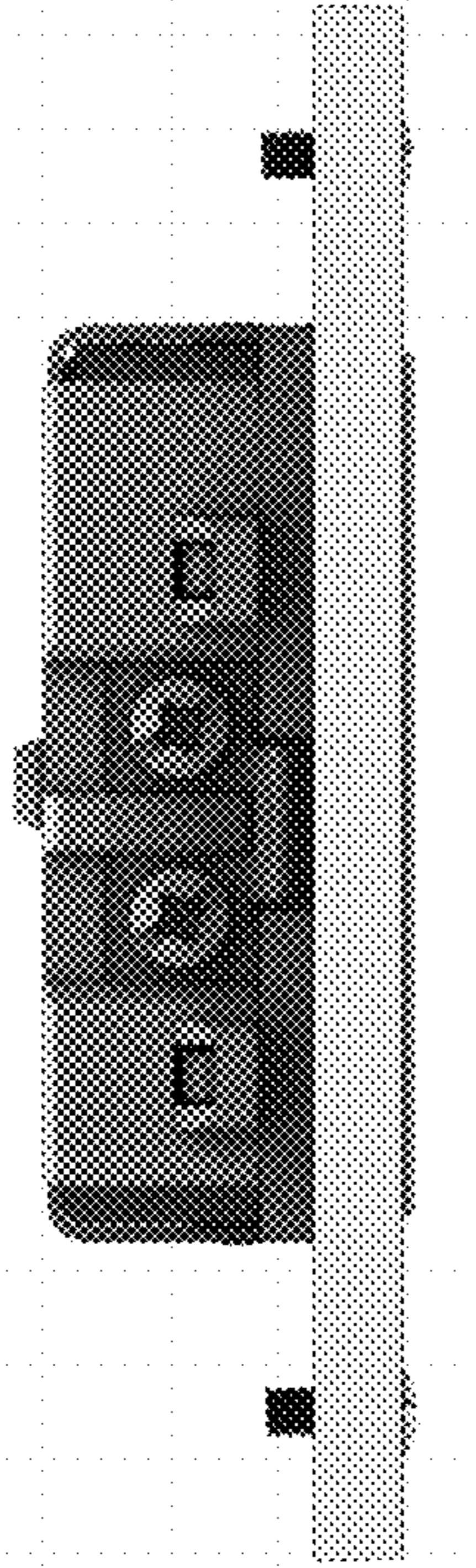

**FIG. 5**

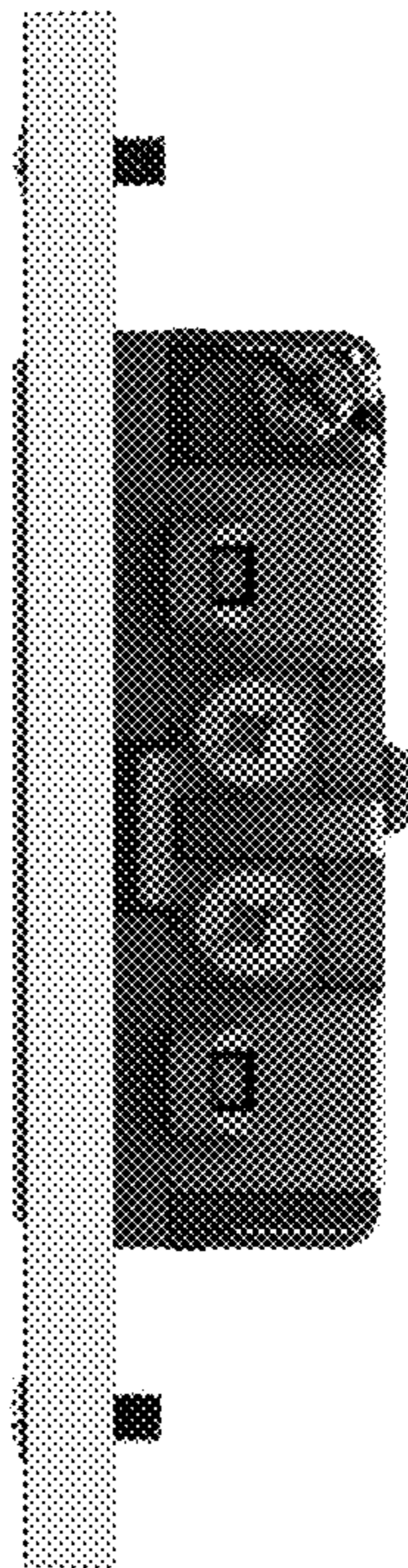

**FIG. 6**

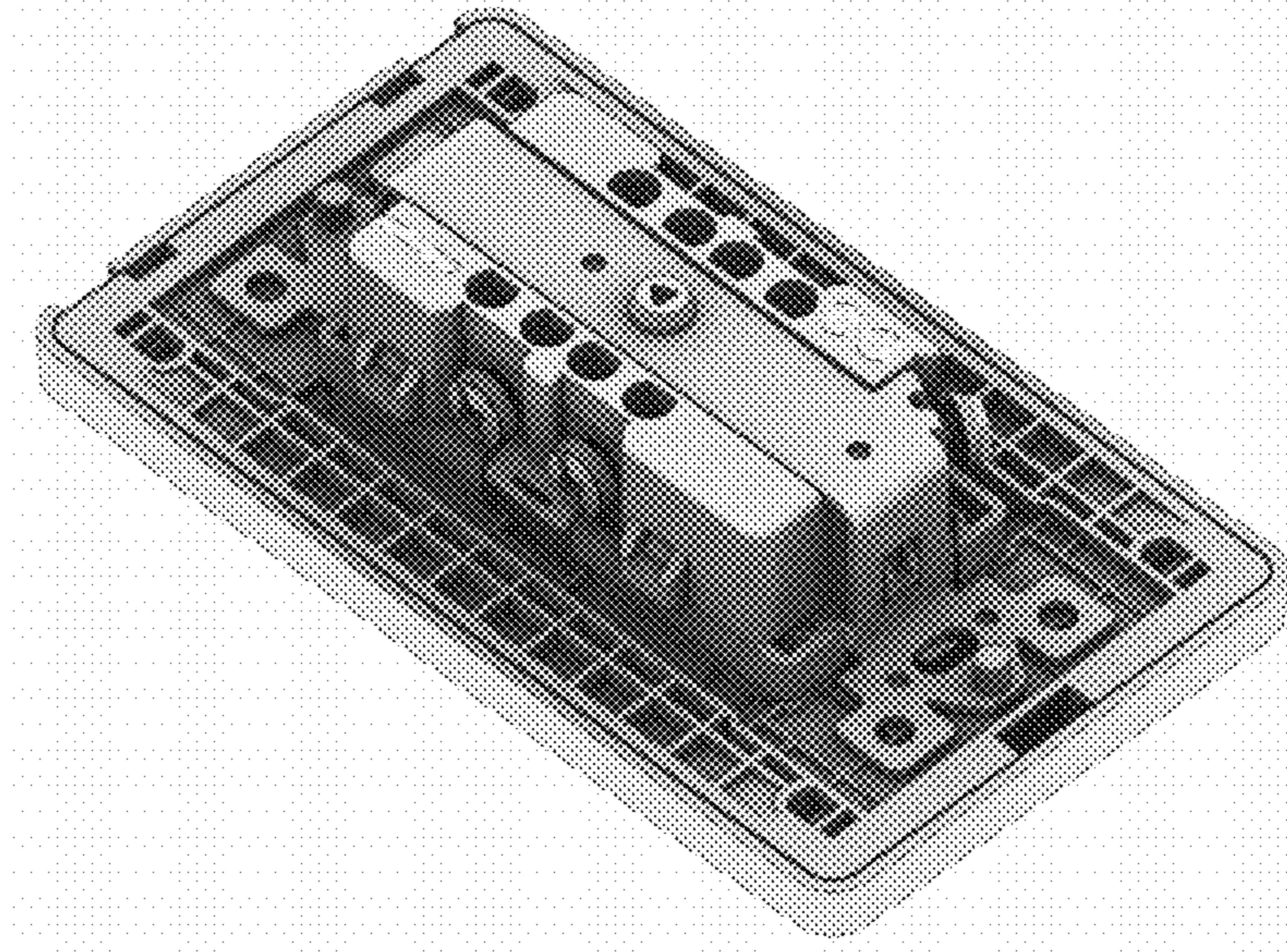

**FIG. 7**

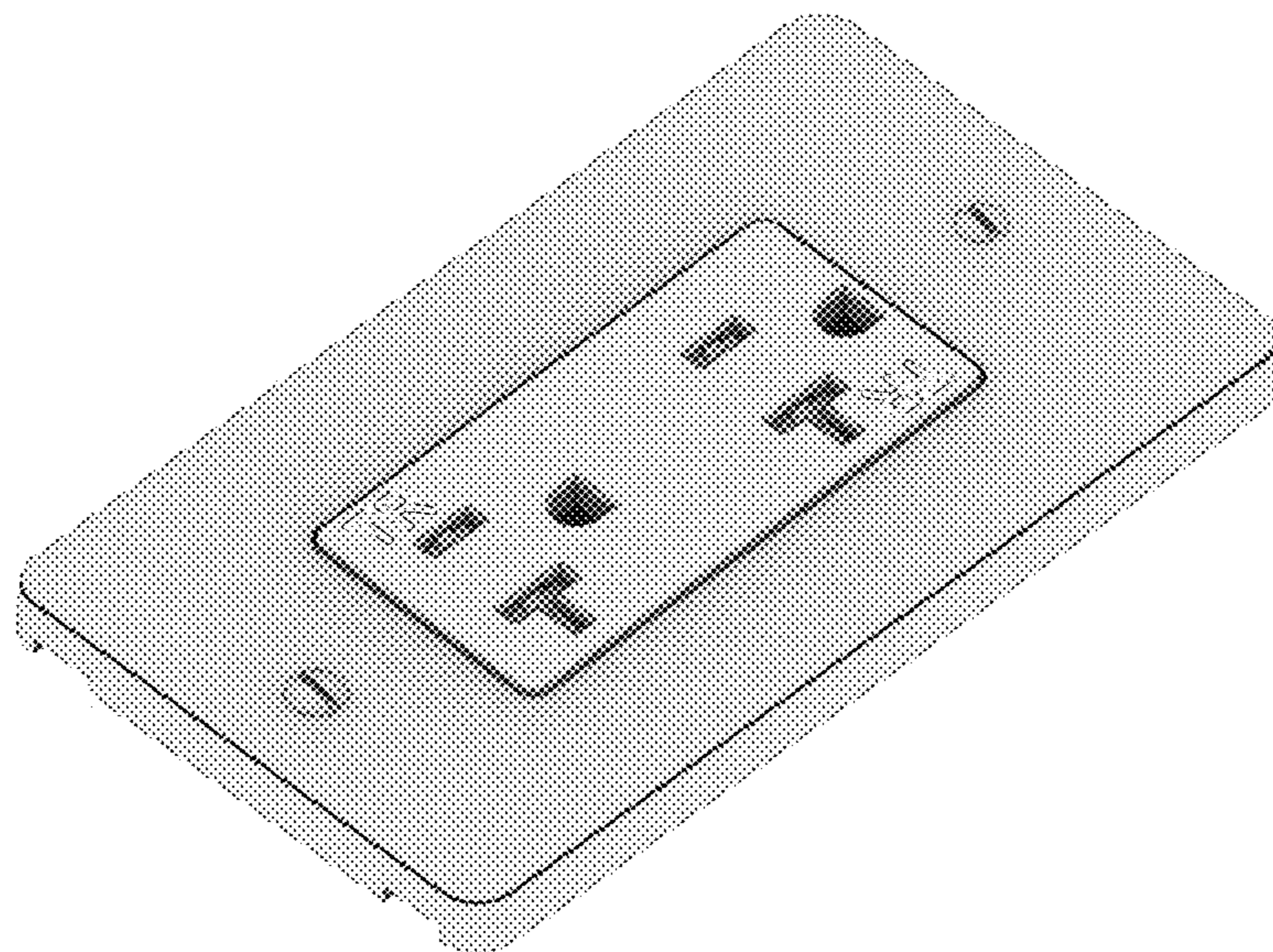

**FIG. 8**