



US00D971064S

(12) **United States Design Patent** (10) **Patent No.:** **US D971,064 S**
Riviere (45) **Date of Patent:** **** Nov. 29, 2022**

(54) **PAIR OF EARRINGS**
(71) Applicant: **Harry Winston SA**, Plan-les-Ouates (CH)
(72) Inventor: **Dominique Riviere**, New York, NY (US)
(73) Assignee: **Harry Winston SA**, Plan-les-Ouates (CH)
(**) Term: **15 Years**

D664,468 S * 7/2012 Gersh D11/89
8,353,181 B2 * 1/2013 Rydlewicz A44C 17/007 D11/90
D691,510 S * 10/2013 Ho D11/56
D726,579 S * 4/2015 Sishodia D11/89
D729,107 S * 5/2015 Riviere D11/42
D753,012 S * 4/2016 Yatsugi-Kang D11/75
(Continued)

(21) Appl. No.: **29/795,980**
(22) Filed: **Jun. 22, 2021**

FOREIGN PATENT DOCUMENTS

CN 306510745 * 5/2021
WO D083684-004 * 11/2014

(30) **Foreign Application Priority Data**

Dec. 28, 2020 (WO) WIPO100582

OTHER PUBLICATIONS

Harry Winston Ruby and Diamond Earrings with AGL Report, available Dec. 6, 2018, online, site visited Jul. 28, 2022. Available online, URL: <https://onlineonly.christies.com/s/christies-jewels-online/harry-winston-ruby-diamond-earrings-agl-report-14/64198> (Year: 2018).*

(51) **LOC (13) Cl.** **11-01**

(Continued)

(52) **U.S. Cl.**
USPC **D11/56; D11/40**

Primary Examiner — W. A. Teddy Falloway

Assistant Examiner — Sarah J Ault

(58) **Field of Classification Search**
USPC ... D11/40-45, 63, 67-69, 75-76, 34, 89, 56
CPC A44C 7/00; A44C 7/001; A44C 7/002;
A44C 7/003; A44C 7/004; A44C 7/005;
A44C 7/006; A44C 7/007; A44C 7/008;
A44C 7/009; A44C 1/00; A44C 17/00;
A44C 17/001; A44C 17/005; A44C
17/007; A44C 17/02; A44C 17/0208

(74) *Attorney, Agent, or Firm* — Blank Rome LLP

See application file for complete search history.

(57) **CLAIM**

The ornamental design for a pair of earrings, as shown and described.

(56) **References Cited**

DESCRIPTION

U.S. PATENT DOCUMENTS

D142,193 S * 8/1945 Katz D11/90
D165,542 S * 12/1951 Philippe D11/78
D196,868 S * 11/1963 Nagy D11/90
D373,551 S * 9/1996 Udko D11/90
D474,992 S * 5/2003 Deorah D11/40
D501,151 S * 1/2005 Tolkowsky D11/90
D659,048 S * 5/2012 Ehrenstrasser D11/89

FIG. 1 is a front view of a pair of earrings of my new design; FIG. 2 is a rear perspective view thereof; FIG. 3 is a left perspective view thereof; FIG. 4 is a right perspective view thereof; FIG. 5 is a top rear perspective view thereof; FIG. 6 is a bottom rear perspective view thereof; FIG. 7 is a front right perspective view thereof; and, FIG. 8 is a rear left perspective view thereof.

1 Claim, 8 Drawing Sheets

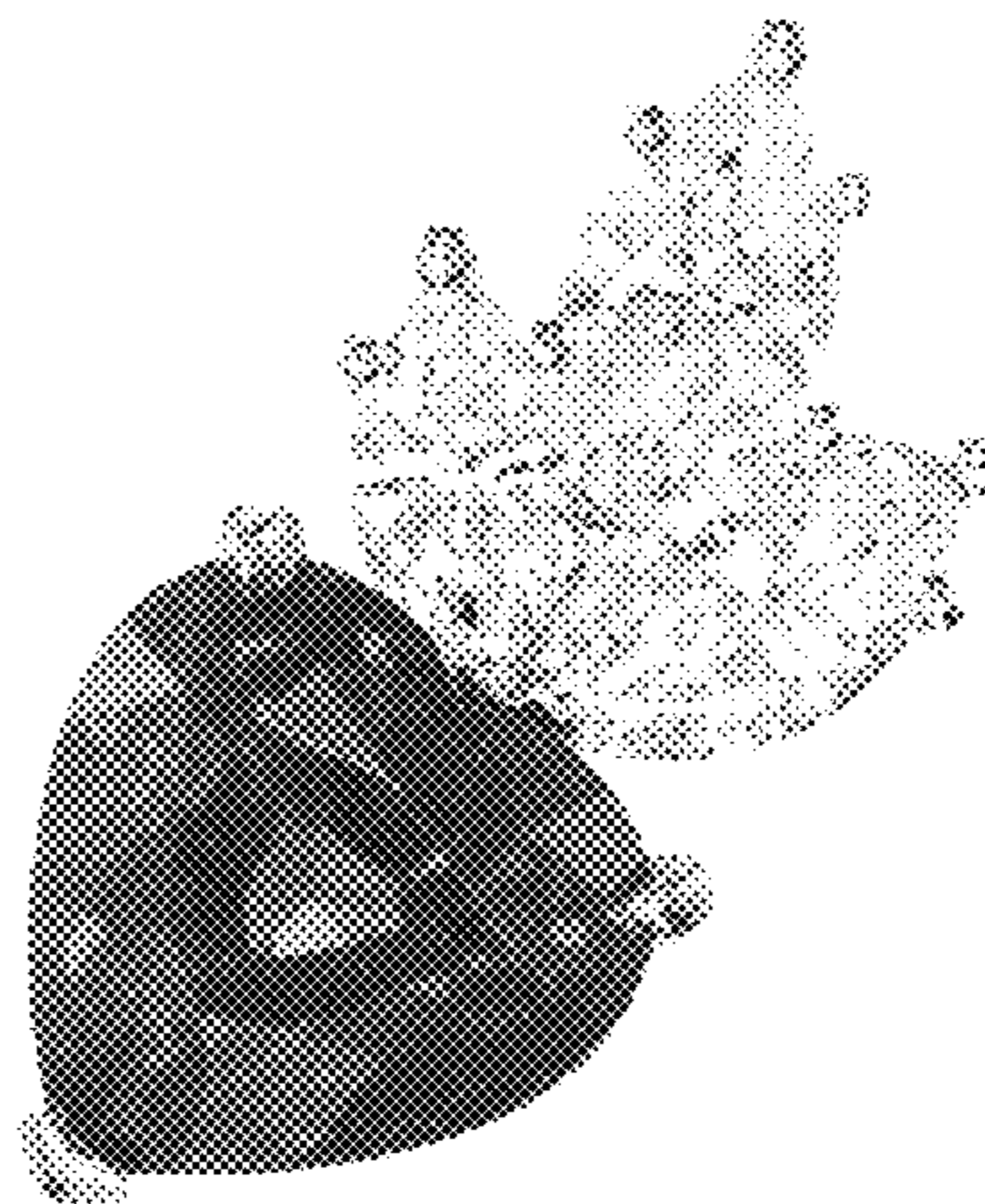

(56)

References Cited

U.S. PATENT DOCUMENTS

D783,442	S	*	4/2017	Yatsugi-Kang	D11/40
D828,210	S	*	9/2018	Wong	D11/34
D828,780	S	*	9/2018	Huang	D11/56
D839,126	S	*	1/2019	Rydlawicz	D11/89
D880,342	S	*	4/2020	Green	D11/103
D903,523	S	*	12/2020	Li	D11/56
D938,853	S	*	12/2021	Abdourahim	D11/42
D938,854	S	*	12/2021	Kwon	D11/42
D939,376	S	*	12/2021	Riviere	D11/42
D942,305	S	*	2/2022	Riviere	D11/42
D946,459	S	*	3/2022	Kwon	D11/34
D952,502	S	*	5/2022	Riviere	D11/34
D954,589	S	*	6/2022	Kwon	D11/34
D955,261	S	*	6/2022	Kwon	D11/42
D955,262	S	*	6/2022	Abdourahim	D11/42
D955,266	S	*	6/2022	Riviere	D11/42

OTHER PUBLICATIONS

Jewellery Insights by Katerina Perez, available Aug. 18, 2021, online, site visited Jul. 28, 2022. Available online, URL: <https://www.katerinaperez.com/articles/harry-winston-all-about-love-jewellery-collection-passion-for-bright-coloured-gemstones> (Year: 2021).*

Milled Milled—Make the Ultimate Commitment with Harry Winston, available May 26, 2021, online, site visited Jul. 28, 2022. Available online, URL: https://milled.com/HarryWinston/make-the-ultimate-commitment-with-harry-winston-bBpL4_upGukzqFyH (Year: 2021).*

* cited by examiner

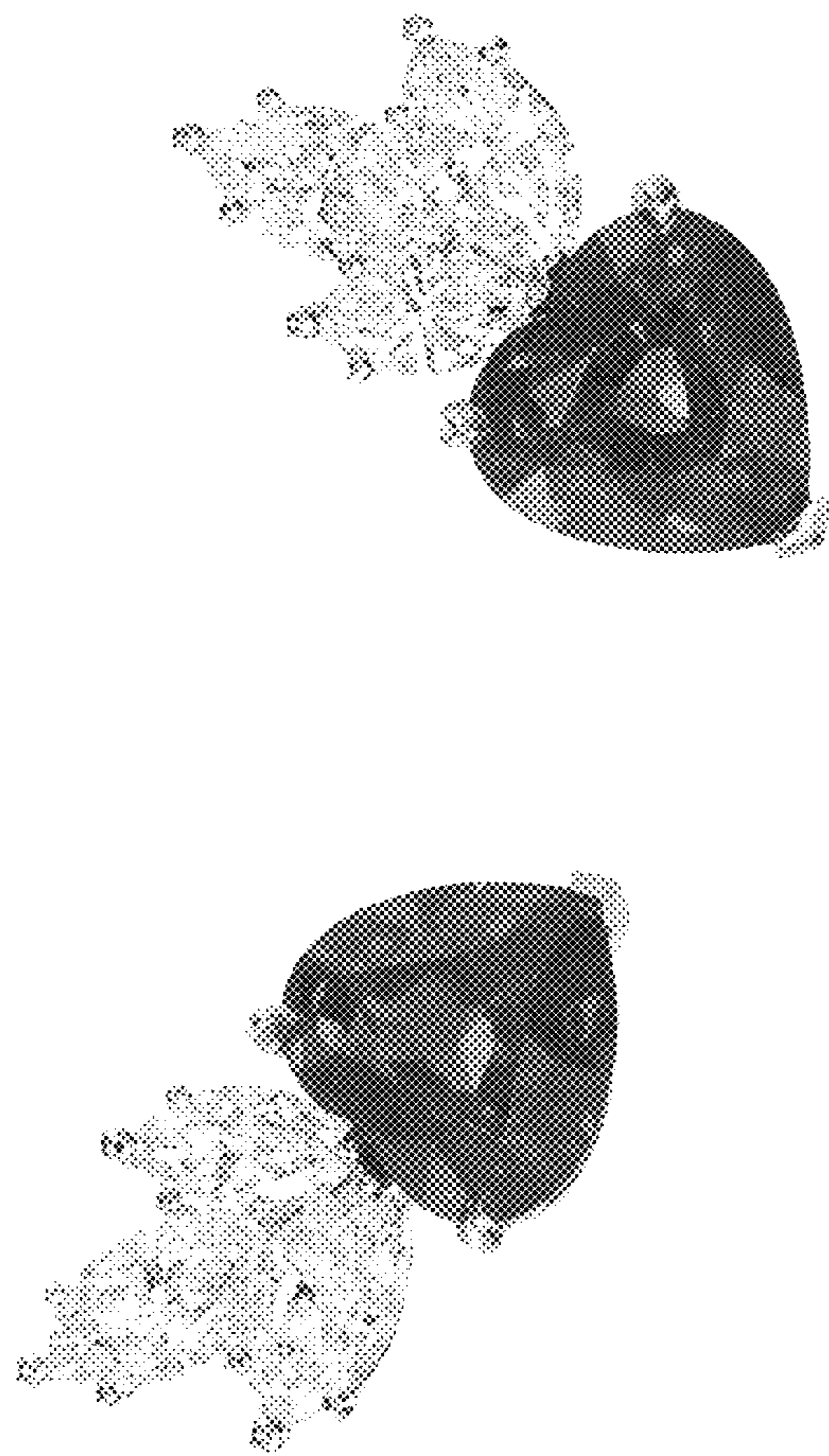

FIG. 1

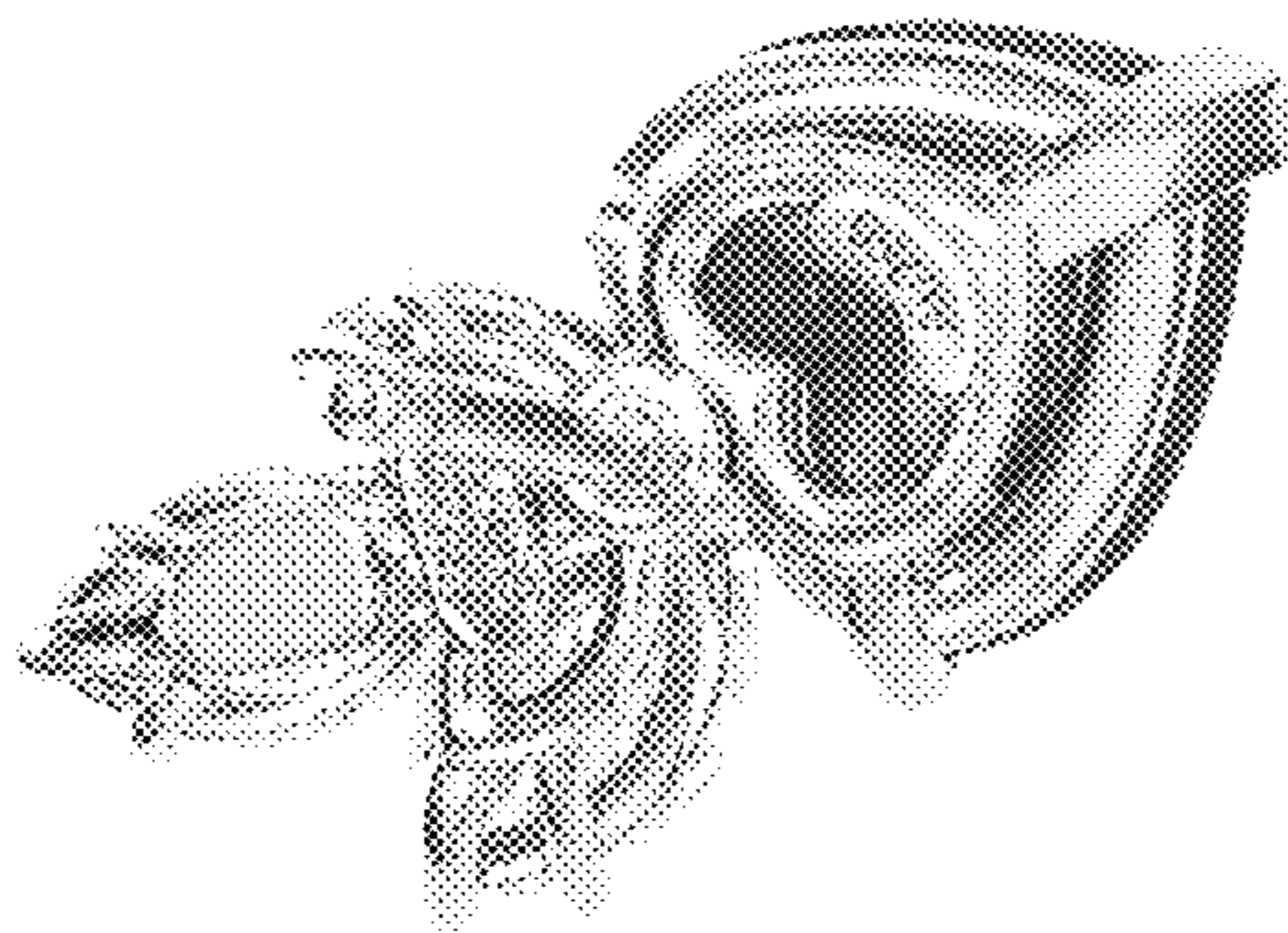
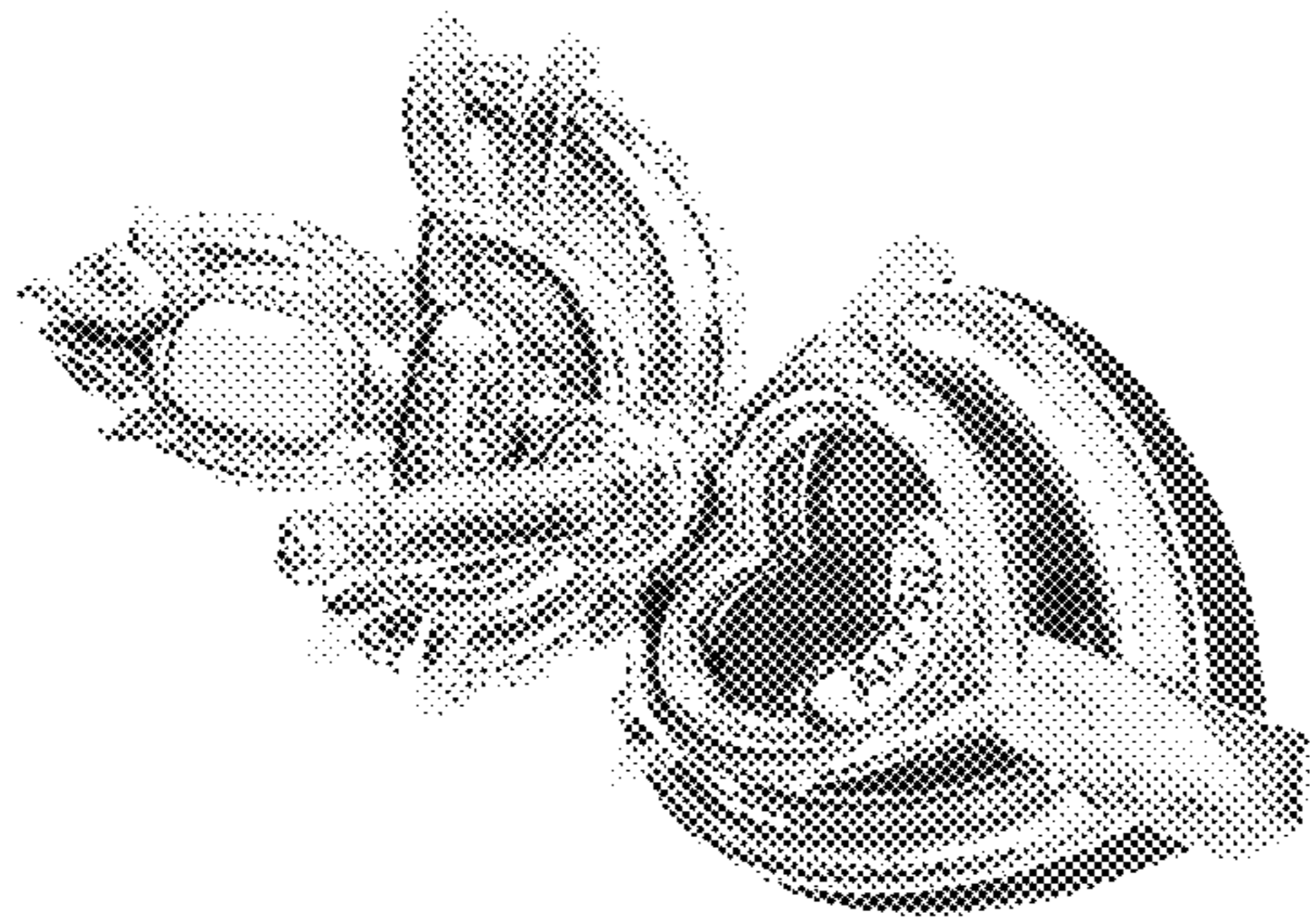

FIG. 2

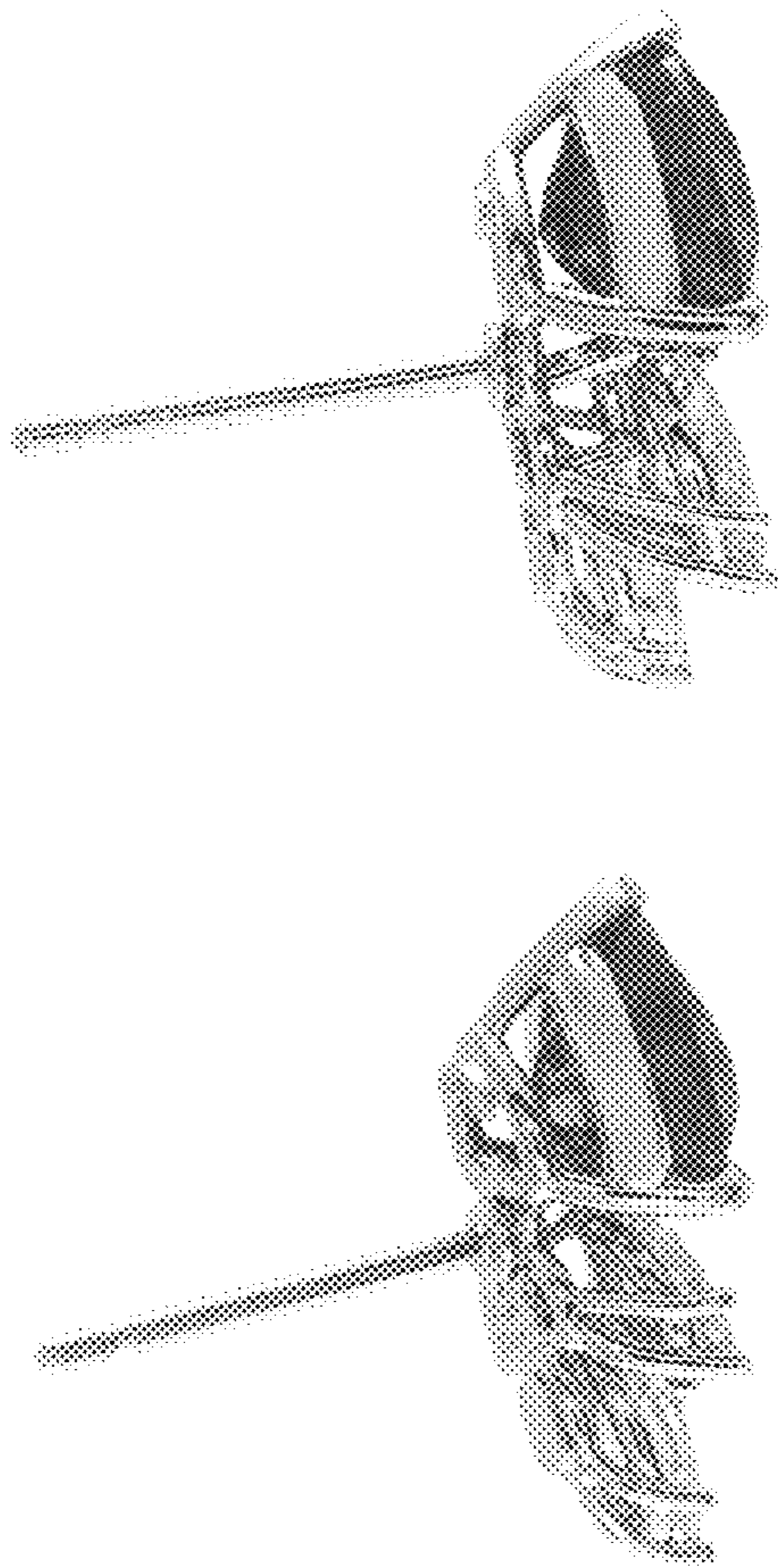

FIG. 3

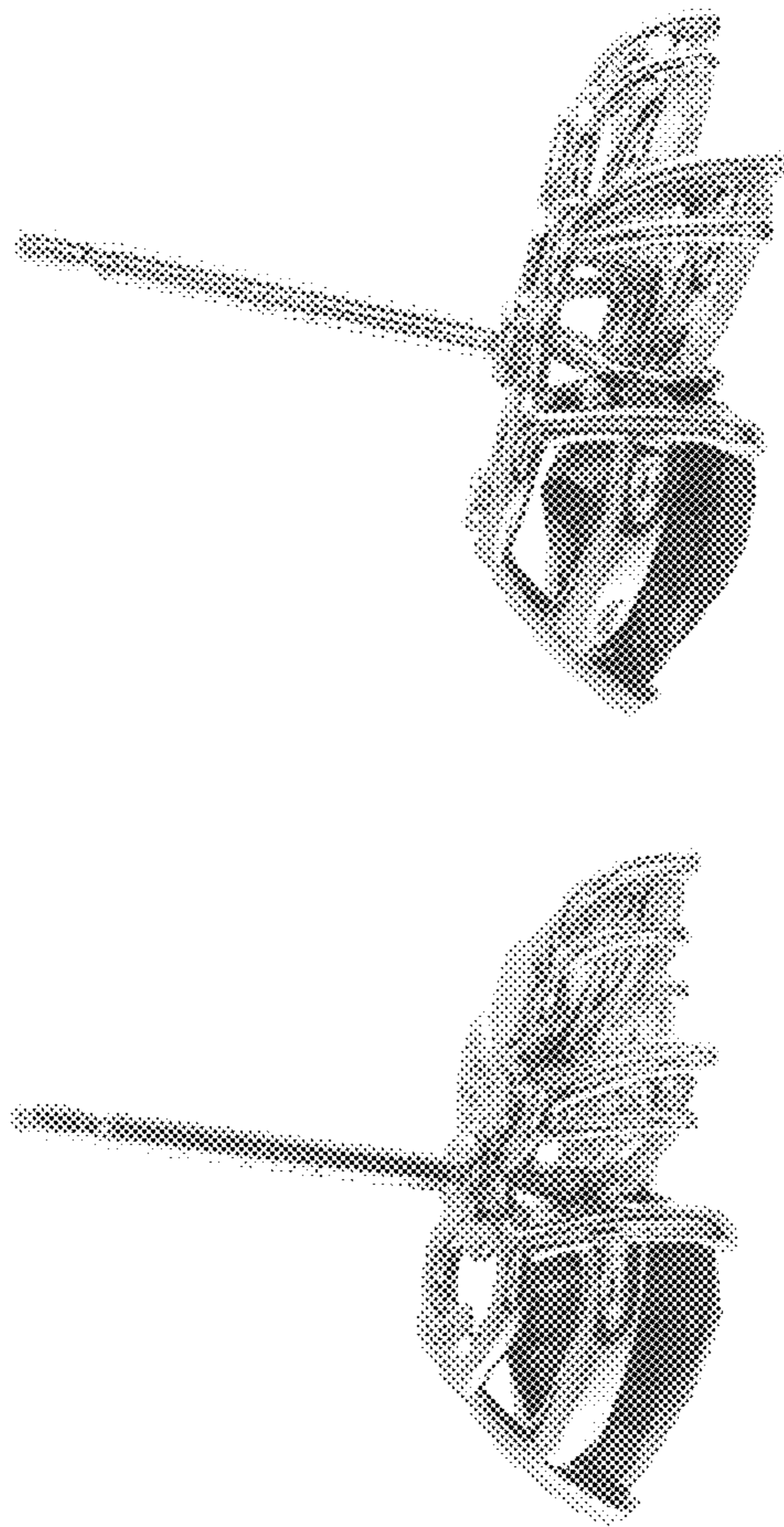

FIG. 4

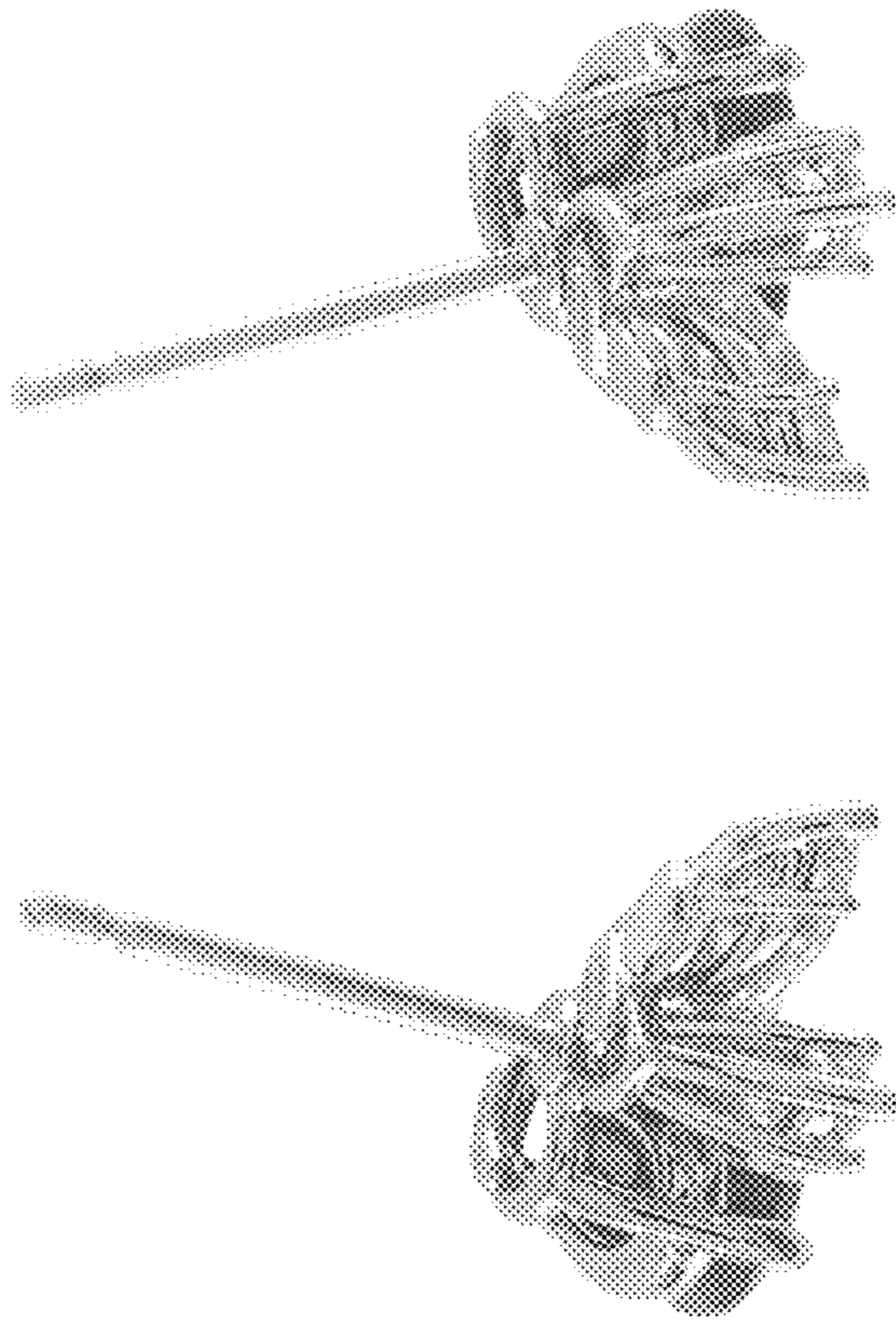

FIG. 5

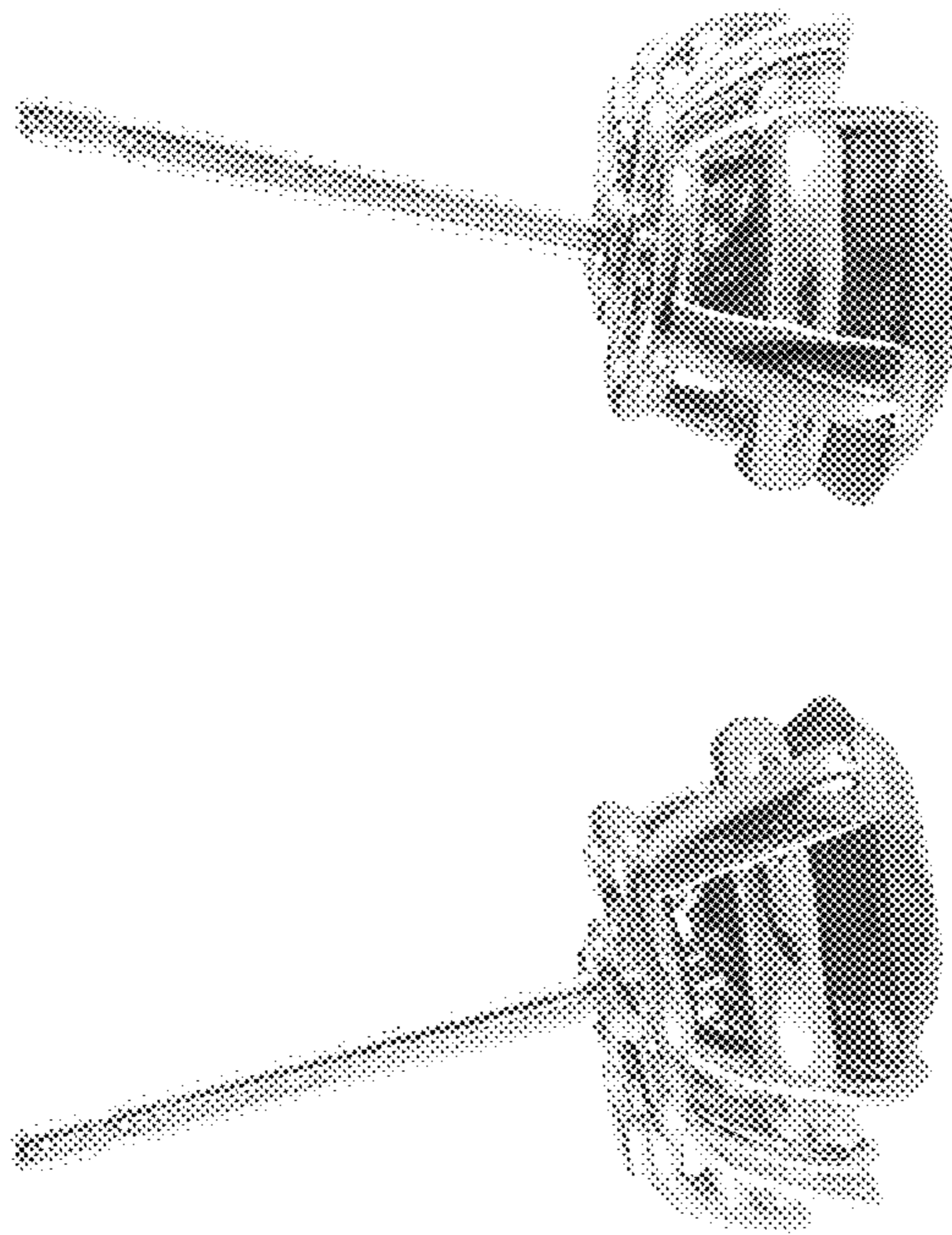

FIG. 6

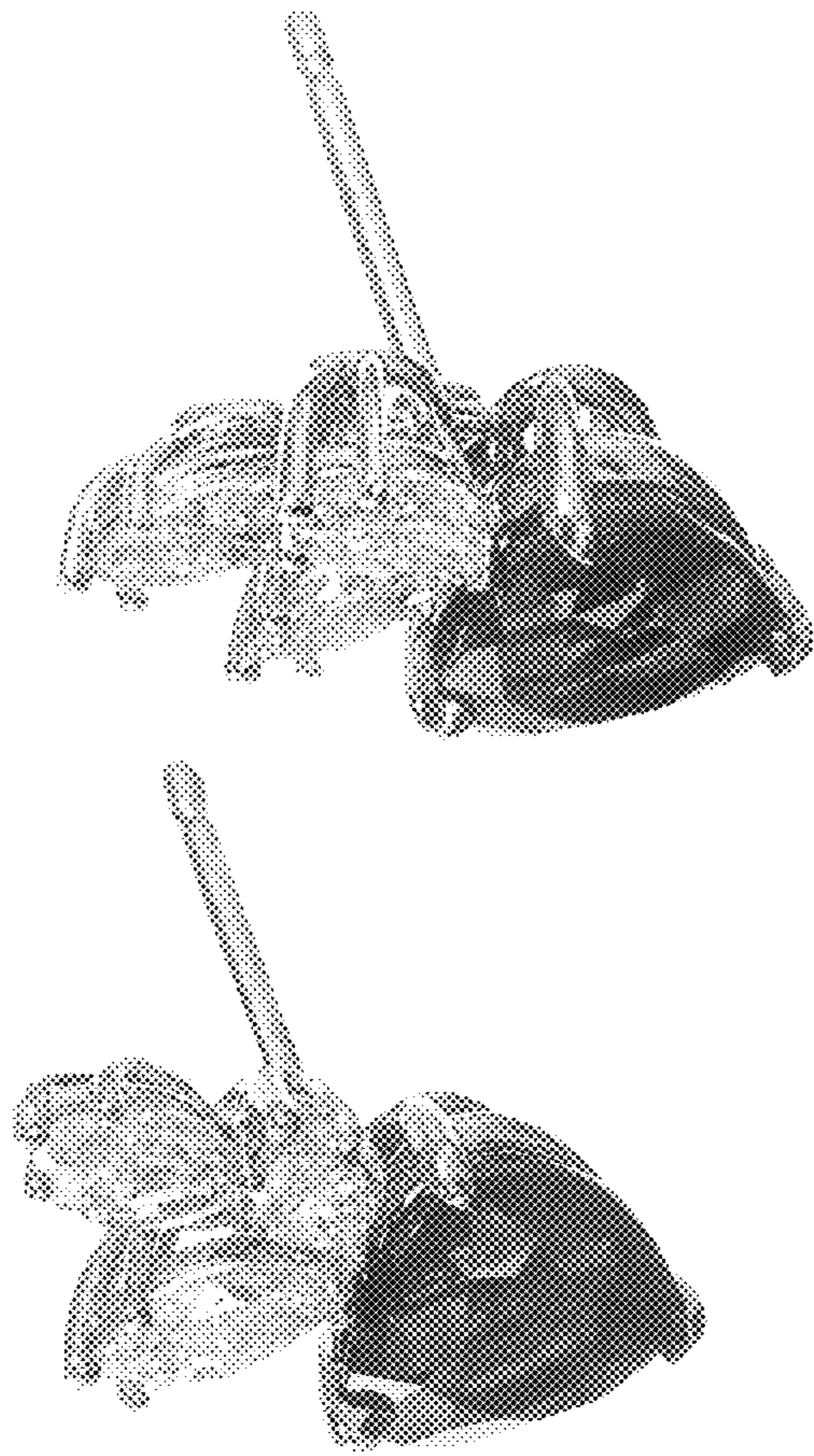

FIG. 7

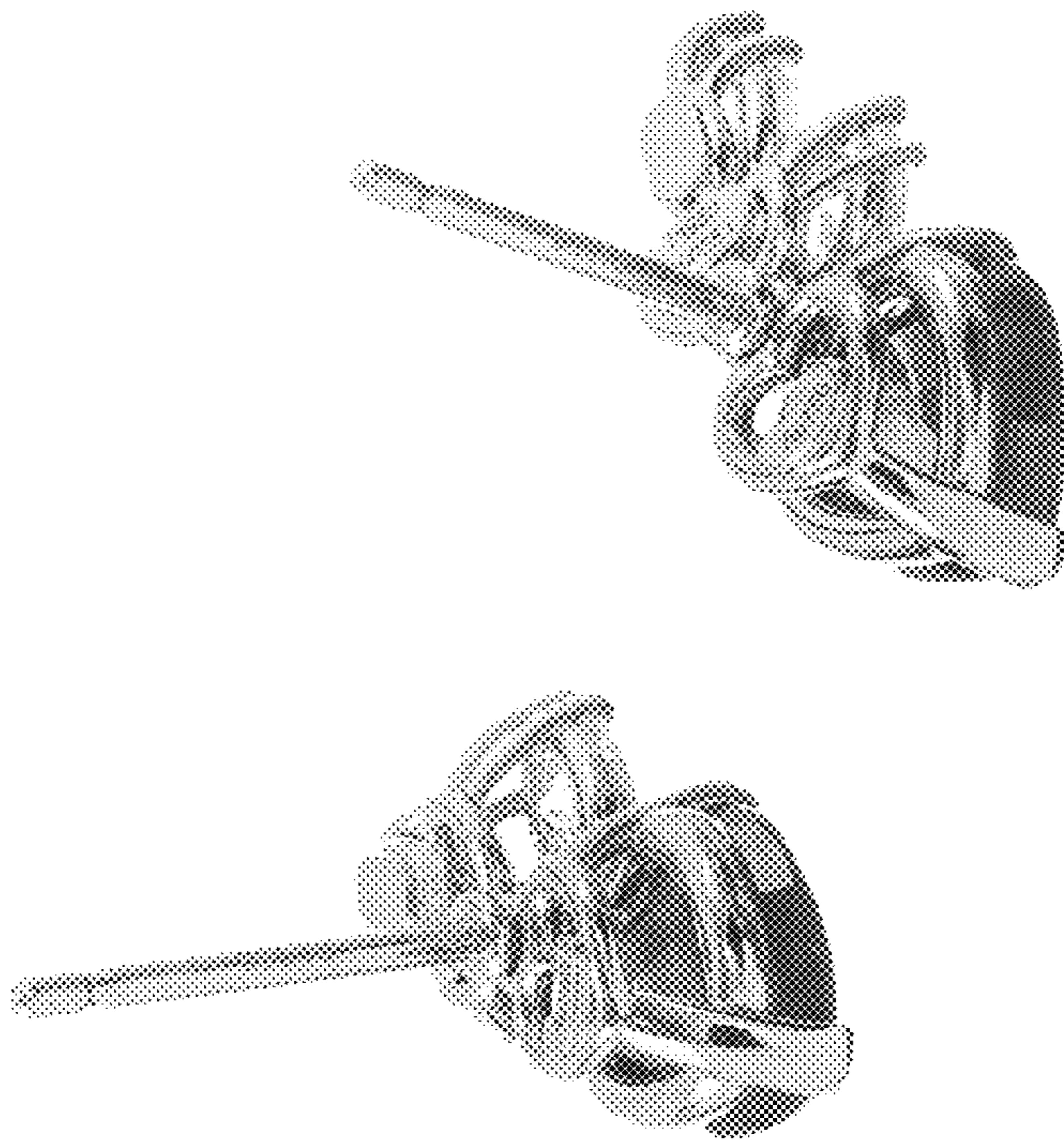

FIG. 8