



US00D971047S

(12) **United States Design Patent** (10) **Patent No.:** **US D971,047 S**
Iida (45) **Date of Patent:** **** Nov. 29, 2022**

(54) **OPERATING PANEL FOR ELEVATOR**

(71) Applicant: **Mitsubishi Electric Corporation,**
Tokyo (JP)

(72) Inventor: **Yuki Iida,** Tokyo (JP)

(73) Assignee: **Mitsubishi Electric Corporation,**
Tokyo (JP)

(**) Term: **15 Years**

(21) Appl. No.: **29/753,488**

(22) Filed: **Sep. 30, 2020**

(30) **Foreign Application Priority Data**

Apr. 6, 2020 (JP) 2020-007210 D

(51) **LOC (13) Cl.** **10-05**

(52) **U.S. Cl.**
USPC **D10/108**

(58) **Field of Classification Search**
USPC D10/108, 106.95; D14/307, 491;
D13/164, 174
See application file for complete search history.

(56) **References Cited**

U.S. PATENT DOCUMENTS

| | | | | |
|--------------|---------|----------------|-------|---------|
| D363,247 S * | 10/1995 | Raymond | | D10/108 |
| D546,724 S * | 7/2007 | Zemp | | D10/108 |
| D587,699 S * | 3/2009 | Corti | | D14/307 |
| D587,700 S * | 3/2009 | Corti | | D14/307 |
| D615,896 S * | 5/2010 | Rusanen | | D10/108 |
| D663,642 S * | 7/2012 | Saikawa | | D13/174 |
| D673,511 S * | 1/2013 | Saikawa | | D13/164 |
| D674,352 S * | 1/2013 | Saikawa | | D13/164 |
| D674,353 S * | 1/2013 | Saikawa | | D13/164 |
| D678,098 S | 3/2013 | Saikawa et al. | | |
| D678,795 S * | 3/2013 | Saikawa | | D13/164 |
| D679,210 S * | 4/2013 | Saikawa | | D13/164 |

| | | | | |
|--------------|---------|---------|-------|---------|
| D679,619 S * | 4/2013 | Saikawa | | D13/164 |
| D681,493 S * | 5/2013 | Saikawa | | D13/164 |
| D696,601 S * | 12/2013 | Saikawa | | D13/164 |
| D699,142 S * | 2/2014 | Saikawa | | D13/164 |

(Continued)

FOREIGN PATENT DOCUMENTS

JP 1434917 S 3/2012

Primary Examiner — George D. Kirschbaum

(74) *Attorney, Agent, or Firm* — Studebaker & Brackett
PC

(57) **CLAIM**

The ornamental design for an operating panel for elevator, as shown and described.

DESCRIPTION

FIG. 1 is a perspective view of an operating panel for elevator, showing my new design;
 FIG. 2 is a front view thereof;
 FIG. 3 is a rear view thereof;
 FIG. 4 is a left side view thereof;
 FIG. 5 is a right side view thereof;
 FIG. 6 is a top view thereof;
 FIG. 7 is a bottom view thereof;
 FIG. 8 is a partially enlarged view taken along line 8-8 of FIG. 2;
 FIG. 9 is a partially enlarged view taken along line 9-9 of FIG. 2;
 FIG. 10 is an enlarged cross-sectional view thereof; taken along line 10-10 of FIG. 8, with the internal system omitted;
 FIG. 11 is an enlarged cross-sectional view thereof; taken along line 11-11 of FIG. 9, with the internal system omitted;
 and,
 FIG. 12 is a front view of the design shown in use.
 The broken line showing of an elevator car in FIG. 9 is included for the purpose of illustrating portions of the “article” and forms no part of the claimed design.

1 Claim, 12 Drawing Sheets

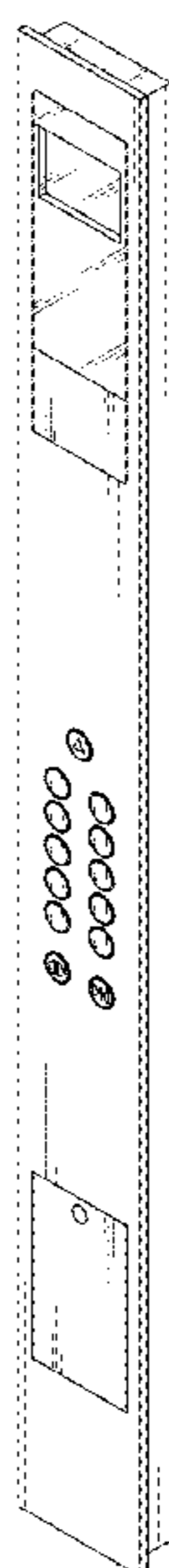

(56)

References Cited

U.S. PATENT DOCUMENTS

| | | | | | | |
|----------|---|---|--------|-----------|-------|---------|
| D701,785 | S | * | 4/2014 | Saikawa | | D10/108 |
| D703,670 | S | * | 4/2014 | Rotsaert | | D14/307 |
| D705,688 | S | * | 5/2014 | Saikawa | | D13/164 |
| D705,689 | S | * | 5/2014 | Saikawa | | D13/164 |
| D721,661 | S | * | 1/2015 | Lofberg | | D13/174 |
| D732,695 | S | * | 6/2015 | Saikawa | | D25/37 |
| D880,327 | S | * | 4/2020 | Costabile | | D10/108 |
| D923,667 | S | * | 6/2021 | Mochizuki | | D15/89 |
| D941,694 | S | * | 1/2022 | Costabile | | D10/108 |
| D949,037 | S | * | 4/2022 | Kollros | | D10/108 |
| D949,728 | S | * | 4/2022 | Kollros | | D10/108 |
| D949,729 | S | * | 4/2022 | Kollros | | D10/108 |
| D957,278 | S | * | 7/2022 | Kollros | | D10/108 |

* cited by examiner

Fig. 1

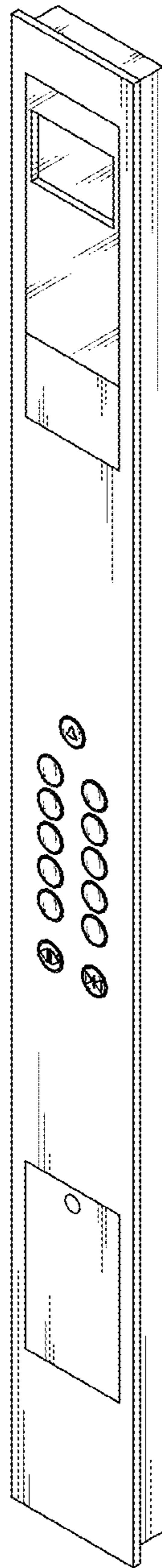

Fig.2

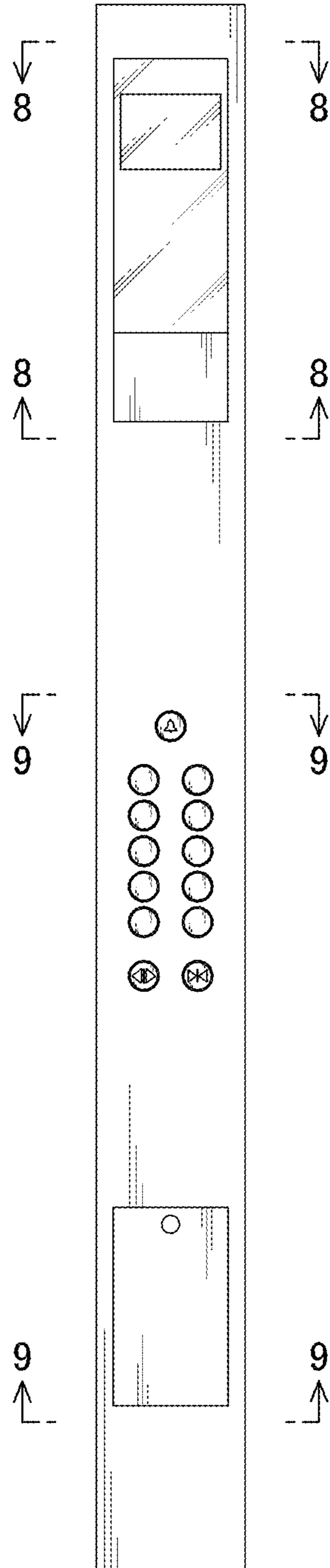

Fig.3

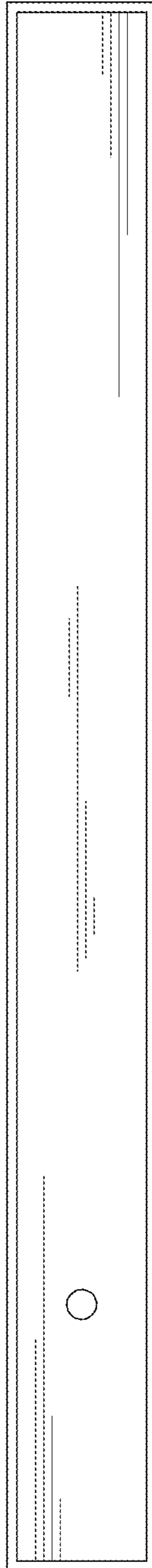

Fig.4

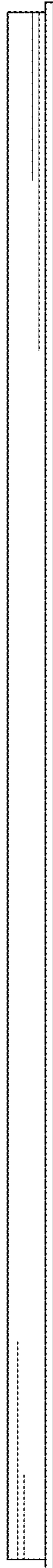

Fig.5

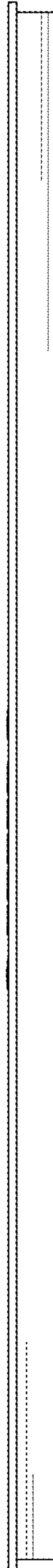

Fig.6

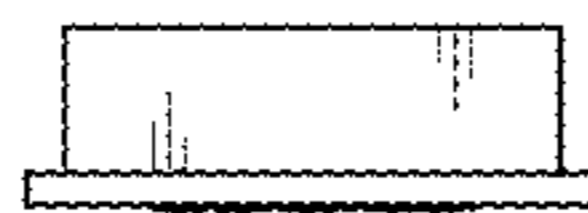
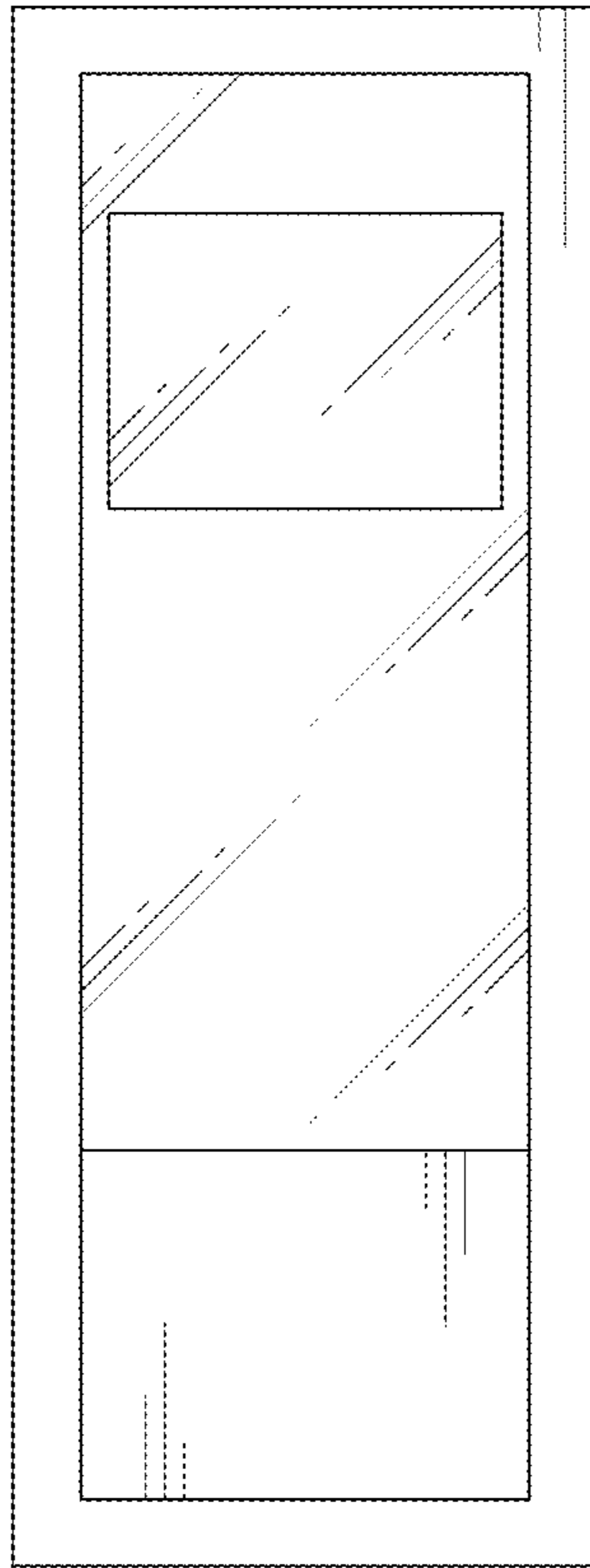

Fig.7



Fig.8

10 ←



10 ←

Fig.9

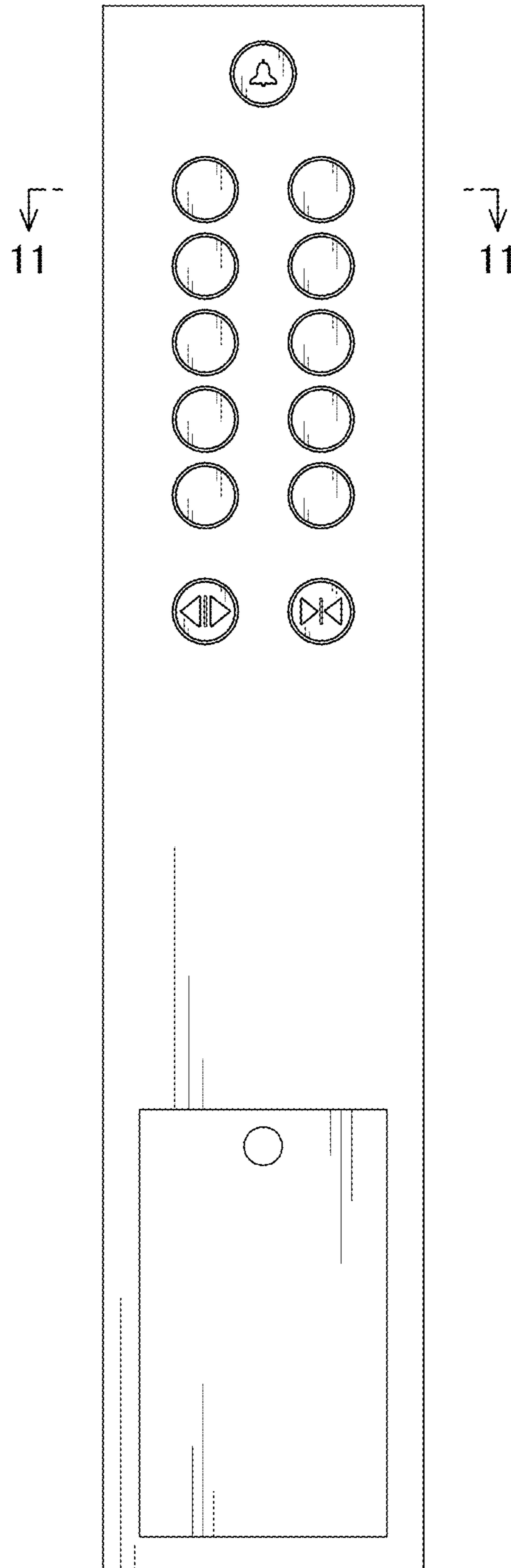

Fig.10

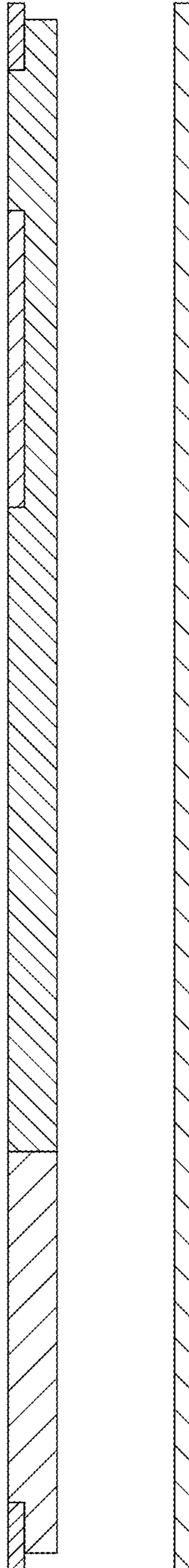

Fig.11

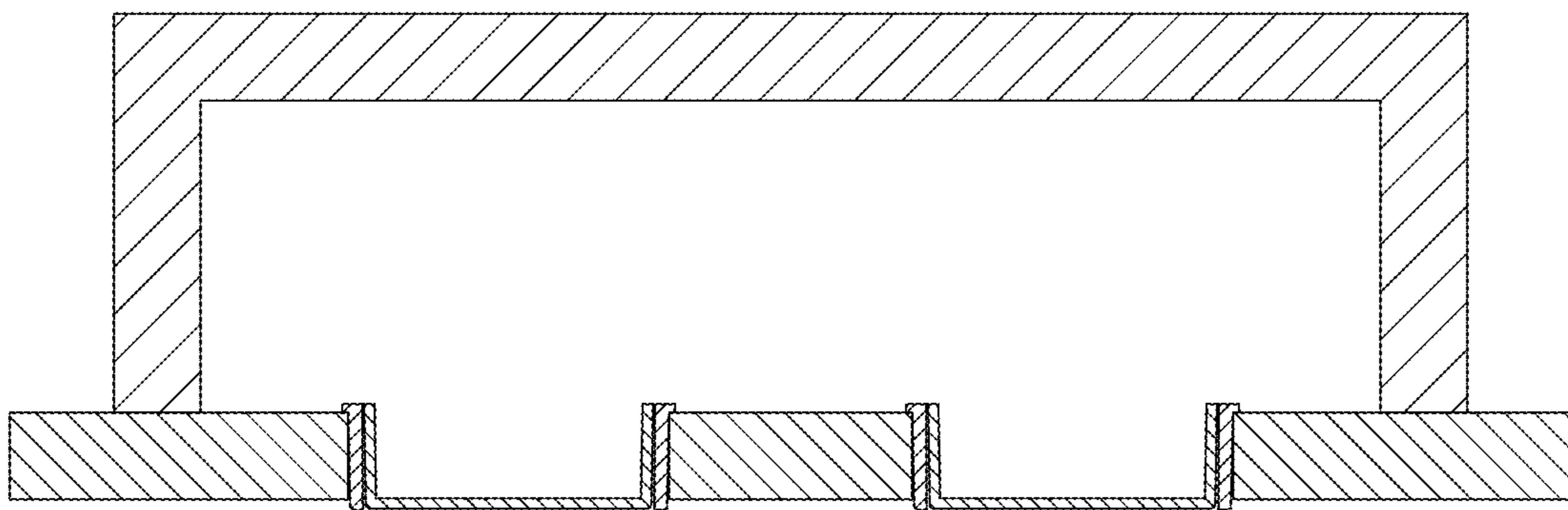

Fig.12

