

US00D971034S

(12) **United States Design Patent** (10) **Patent No.:** **US D971,034 S**
King et al. (45) **Date of Patent:** **** *Nov. 29, 2022**

(54) **PARKING PAY STATION**

(56)

References Cited

(71) Applicant: **IPS Group Inc.**, San Diego, CA (US)

U.S. PATENT DOCUMENTS

(72) Inventors: **David William King**, Rancho Santa Fe, CA (US); **Choor-Hong Tan**, Epping (AU); **Derek Wu**, Strathfield (AU); **David Andrew Jones**, Beecroft (AU)

D161,888 S	2/1951	Wilkin
D246,917 S	1/1978	Sauter
4,615,280 A	10/1986	Shoop et al.
4,754,126 A	6/1988	Caldwell
D331,996 S	12/1992	Fukutake et al.
D336,860 S	6/1993	Clough
D342,209 S	12/1993	Clough
D354,047 S	1/1995	Leggate et al.
D360,734 S	7/1995	Hall
D360,737 S	7/1995	Helbig, Jr.
D375,607 S	11/1996	Hall
D396,655 S	8/1998	Anderson
5,915,246 A	6/1999	Patterson et al.
D412,289 S	7/1999	Winwood
6,029,888 A	2/2000	Harvey
D430,045 S	8/2000	Omuro et al.
D431,788 S	10/2000	Tuxen et al.
D437,468 S	2/2001	Fukutake et al.
D447,519 S	9/2001	Pinchuk et al.
D448,910 S	10/2001	Kit
D450,253 S	11/2001	Marguet
D454,421 S	3/2002	Jeon
D460,005 S	7/2002	Jacquet
D472,362 S	3/2003	Zerman et al.
6,527,172 B1	3/2003	Lewis et al.
D481,516 S	10/2003	Magee
D485,417 S	1/2004	Magee
D488,280 S	4/2004	Zerman
D492,080 S	6/2004	Magee
D492,081 S	6/2004	Magee
D494,730 S	8/2004	Magee
D497,814 S	11/2004	Odinotski et al.
D505,240 S	5/2005	Swaine et al.
D505,765 S	5/2005	Swaine et al.
D510,751 S	10/2005	Magee et al.
7,004,385 B1	2/2006	Douglass
7,040,534 B2 *	5/2006	Turocy G07F 19/202 902/8
D530,880 S	10/2006	Magee et al.
7,131,576 B2	11/2006	Utz et al.
D538,505 S	3/2007	Kang
7,222,782 B2	5/2007	Lute, Jr. et al.
7,347,368 B1	3/2008	Gravelle et al.
D570,920 S	6/2008	Choi
7,419,091 B1	9/2008	Scanlon
D579,795 S	11/2008	Martinez et al.
7,445,144 B2	11/2008	Schlabach et al.
D582,125 S	12/2008	Kang et al.
D592,825 S	5/2009	Kang et al.

(73) Assignee: **IPS GROUP INC.**, San Diego, CA (US)

(*) Notice: This patent is subject to a terminal disclaimer.

(**) Term: **15 Years**

(21) Appl. No.: **29/700,893**

(22) Filed: **Aug. 6, 2019**

(51) **LOC (13) Cl.** **10-03**

(52) **U.S. Cl.**

USPC **D10/42**; D99/28; D18/4.4; D18/4.6

(58) **Field of Classification Search**

USPC D99/28, 34, 35, 36, 43, 99; D10/40, 41, D10/42; D14/300, 301, 302, 305, 307, D14/900-902; D21/324, 325, 329, 369, D21/370; D18/3.1, 3.2, 3.3, 4.1, 4.2, 4.3, D18/4.4, 4.5, 4.6, 11, 12, 12.1, 12.2, D18/12.3; 705/16, 17, 18, 42, 43, 44, 45; 235/379, 380, 381; 194/205; 109/1 R, 109/1 V, 2, 23, 24.1, 25, 58, 58.5, 66; 52/36.1; 101/66

CPC .. G06Q 20/10; G06Q 20/108; G06Q 20/1085; G06Q 20/18; G07D 1/00; G07D 1/02; G07D 1/04; G07D 1/06; G07D 11/00; G07D 9/002; G07D 9/04; G07F 19/20; G07F 19/201; G07F 19/202; G07F 19/203; G07F 19/204; G07F 19/205; G07F 19/21; G07F 19/00; G07F 7/04; G07F 5/00; G07F 1/00; E05G 7/001

See application file for complete search history.

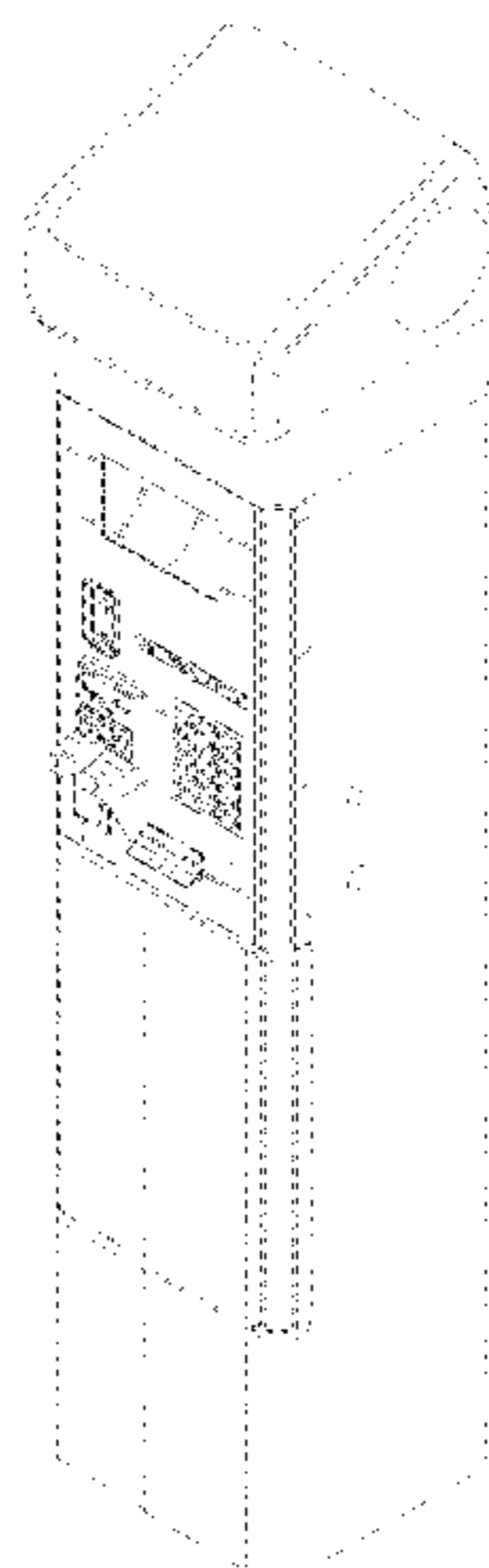

US D971,034 S

7,533,802 B1	5/2009	McGinley et al.		D863,075 S *	10/2019	MacKay	D10/42
D596,373 S	7/2009	Kang et al.		D863,076 S *	10/2019	MacKay	D10/42
D596,374 S	7/2009	Kang		D863,987 S *	10/2019	MacKay	D10/42
7,575,166 B2	8/2009	McNamara		D863,988 S *	10/2019	MacKay	D10/42
7,611,045 B1	11/2009	Lute et al.		D879,404 S *	3/2020	Morishita	D99/28
7,624,919 B2	12/2009	Meek et al.		D883,605 S *	5/2020	Lee	D99/28
7,699,224 B2	4/2010	Mole		RE48,566 E *	5/2021	MacKay	G09F 23/00 D10/42
D615,274 S	5/2010	Kim et al.		2004/0016796 A1 *	1/2004	Hanna	G07D 11/14 705/64
7,717,327 B2	5/2010	Gomes et al.		2004/0059693 A1	3/2004	Hausen et al.	
7,726,558 B1	6/2010	Lute et al.		2004/0262379 A1 *	12/2004	Gomes	G07F 17/0014 235/379
D625,305 S	10/2010	Bleck		2005/0029340 A1	2/2005	Ferraro	
D629,585 S	12/2010	Bleck et al.		2006/0152385 A1 *	7/2006	Mandy	G07F 17/24 340/932.2
D632,740 S	2/2011	Adeline		2007/0046651 A1	3/2007	Sinclair et al.	
7,891,546 B1	2/2011	Steinbach et al.		2007/0276724 A1	11/2007	Catt et al.	
D645,223 S	9/2011	Bleck		2008/0257965 A1	10/2008	Klein et al.	
D652,872 S	1/2012	Mougin et al.		2008/0265019 A1	10/2008	Artino et al.	
D653,014 S	1/2012	Rohan		2008/0296365 A1	12/2008	Schliebe	
D653,420 S	1/2012	Rohan		2009/0057398 A1	3/2009	Douglass et al.	
D653,421 S	1/2012	Rohan		2010/0161489 A1	6/2010	Goodall et al.	
D653,424 S	1/2012	Rohan		2010/0187300 A1	7/2010	Ramachandran et al.	
8,181,857 B1	5/2012	Lute et al.		2010/0241564 A1	9/2010	Miller et al.	
D672,525 S	12/2012	Lee et al.		2010/0243729 A1	9/2010	Russell et al.	
D674,985 S	1/2013	Lee		2011/0133613 A1	6/2011	Descamps et al.	
D677,035 S	2/2013	Lee		2011/0320243 A1	12/2011	Khan	
D677,714 S	3/2013	Helgesson et al.		2012/0286036 A1	11/2012	Jones et al.	
D680,156 S	4/2013	Hernandez et al.		2014/0165885 A1	6/2014	Denny et al.	
D681,717 S	5/2013	Helgesson et al.					
D682,504 S	5/2013	Lee et al.					
D691,165 S	10/2013	Attoma					
D693,983 S	11/2013	Budde et al.					
8,573,484 B1	11/2013	Irudayam et al.					
D696,484 S	12/2013	Lee					
D696,485 S	12/2013	Lee					
D702,913 S	4/2014	Budde					
D702,914 S	4/2014	Budde					
D716,515 S	10/2014	Cha					
D722,740 S	2/2015	Budde					
D724,290 S	3/2015	Cha et al.					
D724,811 S	3/2015	Reitinger					
D724,812 S	3/2015	Cha et al.					
D725,504 S	3/2015	McEneaney et al.					
D728,190 S	4/2015	Sheley					
D732,263 S	6/2015	Budde et al.					
D735,437 S	7/2015	Randall et al.					
D735,438 S	7/2015	Randall et al.					
D735,440 S	7/2015	Randall et al.					
D735,963 S	8/2015	Randall et al.					
D735,965 S	8/2015	Randall et al.					
D739,637 S	9/2015	Randall					
D739,638 S	9/2015	Randall					
D739,639 S	9/2015	Randall					
D741,040 S	10/2015	Budde et al.					
D742,090 S	10/2015	Randall					
D743,956 S *	11/2015	Kraft	D14/307				
D746,015 S	12/2015	King et al.					
D748,364 S	1/2016	King et al.					
D748,888 S	2/2016	King et al.					
D749,290 S	2/2016	Pollmann					
D762,040 S	7/2016	King et al.					
D769,570 S	10/2016	Kraft et al.					
D769,571 S	10/2016	Lee et al.					
D769,572 S	10/2016	Park et al.					
D779,771 S	2/2017	King et al.					
D779,772 S	2/2017	King et al.					
D779,773 S	2/2017	King et al.					
D779,774 S *	2/2017	King	D99/28				
D781,024 S	3/2017	King et al.					
D791,621 S	7/2017	Loye et al.					
D792,049 S *	7/2017	Oh	D99/28				
D795,523 S	8/2017	King et al.					
D802,874 S	11/2017	King et al.					
D802,875 S	11/2017	King et al.					
D802,876 S	11/2017	King et al.					
D802,877 S	11/2017	King et al.					
D802,878 S	11/2017	King et al.					
9,842,455 B2 *	12/2017	MacKay	G07F 17/248				
D813,059 S *	3/2018	MacKay	D99/28				
D832,553 S *	10/2018	Angelopoulos	D99/28				
D863,074 S *	10/2019	MacKay	D10/42				

FOREIGN PATENT DOCUMENTS

AT	507762	A1	7/2010
CA	2517717	A1	9/2004
EP	1227448	A2	7/2002
FR	2928678	A1	9/2009
FR	2979726	A1	3/2013
JP	3441832	B2	9/2003
JP	4247079	B2	4/2009
JP	5238316	B2	7/2013
WO	WO-02084600	A1	10/2002
WO	WO-03065322	A1	8/2003
WO	WO-2010062105	A2	6/2010
WO	WO-2014127384	A1	8/2014

OTHER PUBLICATIONS

Parking Pay Stations, <https://www.cityofcocoabeach.com/642/Parking-Pay-Stations>, retrieved on Jun. 10, 2021. (Year: 2021).*

No change for car park charge? Just RingGo, <https://www.northern-times.co.uk/news/no-change-for-car-park-charge-just-ringgo-140901/>, Jul. 6, 2017 (Year: 2017).*

Co-pending U.S. Appl. No. 16/441,800, filed Jun. 14, 2019.

Co-pending U.S. Appl. No. 29/700,889, filed Aug. 6, 2018.

Co-pending U.S. Appl. No. 29/700,891, filed Aug. 6, 2019.

Co-pending U.S. Appl. No. 29/700,892, filed Aug. 6, 2019.

Co-pending U.S. Appl. No. 29/700,894, filed Aug. 6, 2019.

E-Bay: Amano McGann MSM Metric Elite LS Solar Electric Parking Lot Credit Pay Station, 5 pages. www.ebay.com/itm/363873148900 (2022).

Nebraska Innovation Campus: Additional way to pay metered street parking at NIC, <https://innovate.unl.edu/news/additional-way-pay-metered-street-parking-nic>, 2 pages(2022).

* cited by examiner

Primary Examiner — Elizabeth J Oswecki
(74) *Attorney, Agent, or Firm* — Wilson Sonsini Goodrich & Rosati

(57) CLAIM

The ornamental design for a parking pay station, as shown and described.

DESCRIPTION

FIG. 1 is a top front right perspective view of a parking pay station, showing our new design;

FIG. 2 is a top back left perspective view thereof;

FIG. 3 is a front elevational view thereof;

FIG. 4 is a back elevational view thereof;

FIG. 5 is a left side elevational view thereof;

FIG. 6 is a right side elevational view thereof; and,

FIG. 7 is a top plan view thereof.

The broken lines shown in the drawings represent portions of the parking pay station that form no part of the claimed design. The letters, number, and symbols on the buttons and panels shown in FIGS. 1 and 3 and the small circles in FIG. 7 are in broken lines and form no part of the claimed design.

1 Claim, 7 Drawing Sheets

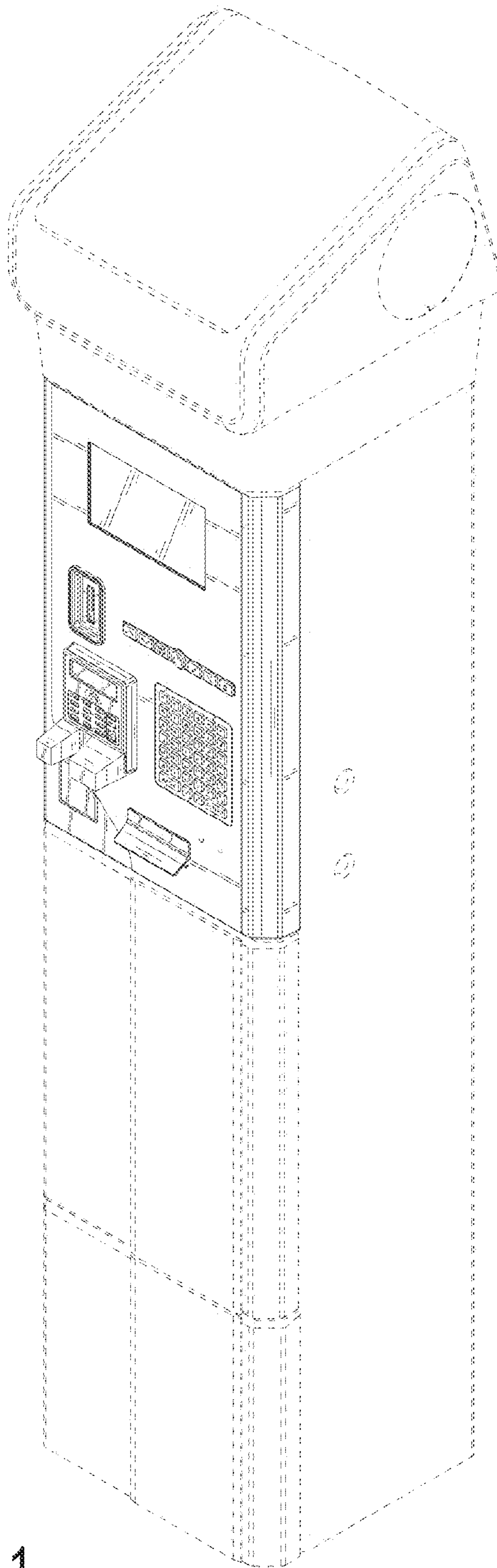

FIG. 1

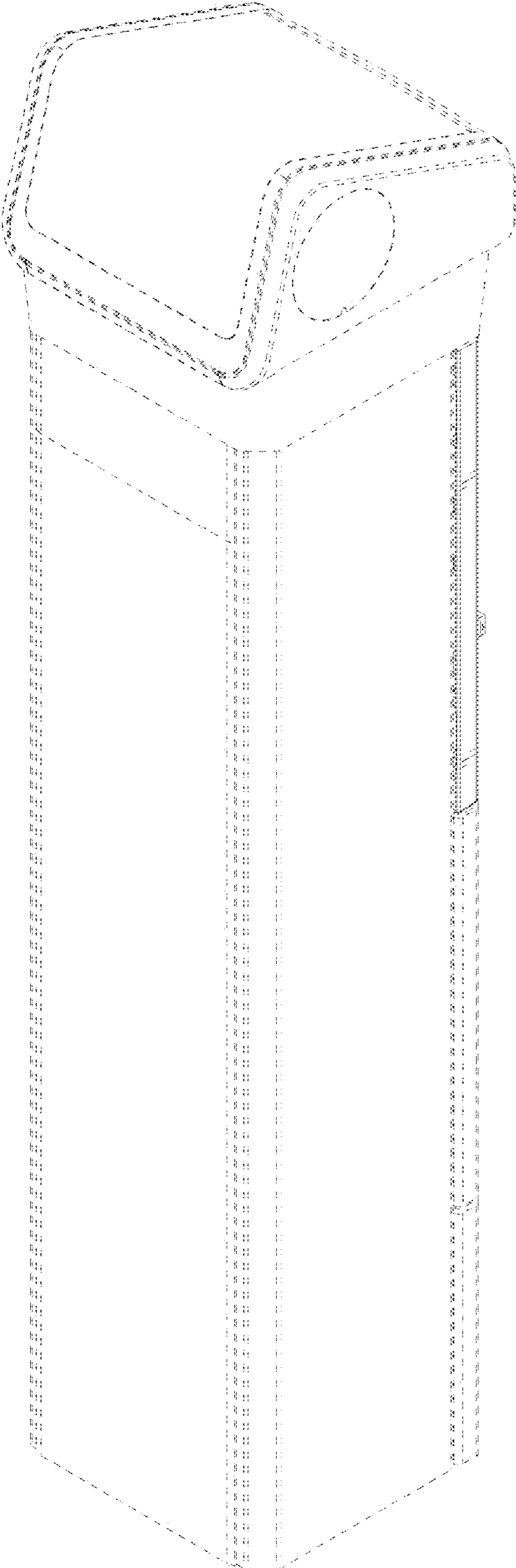

FIG. 2

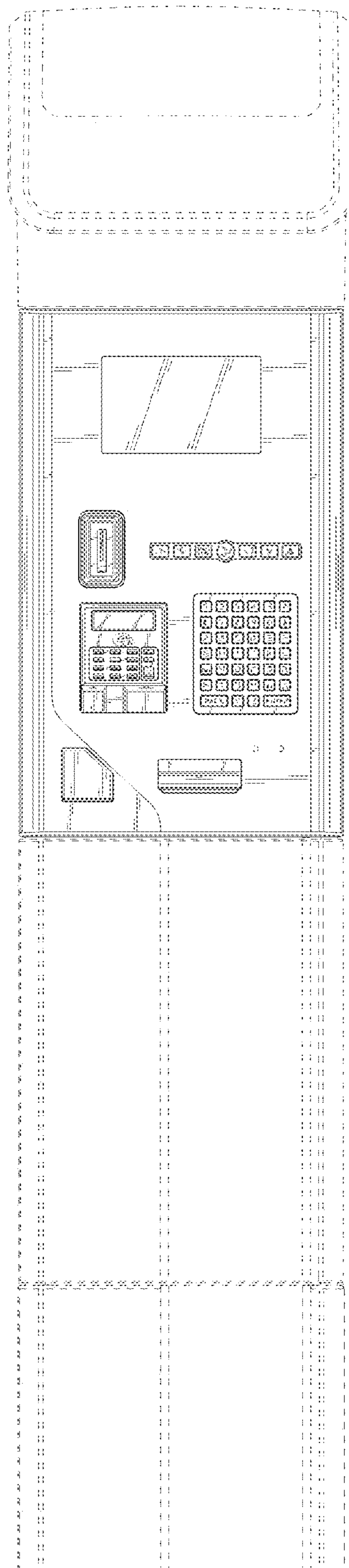

FIG. 3

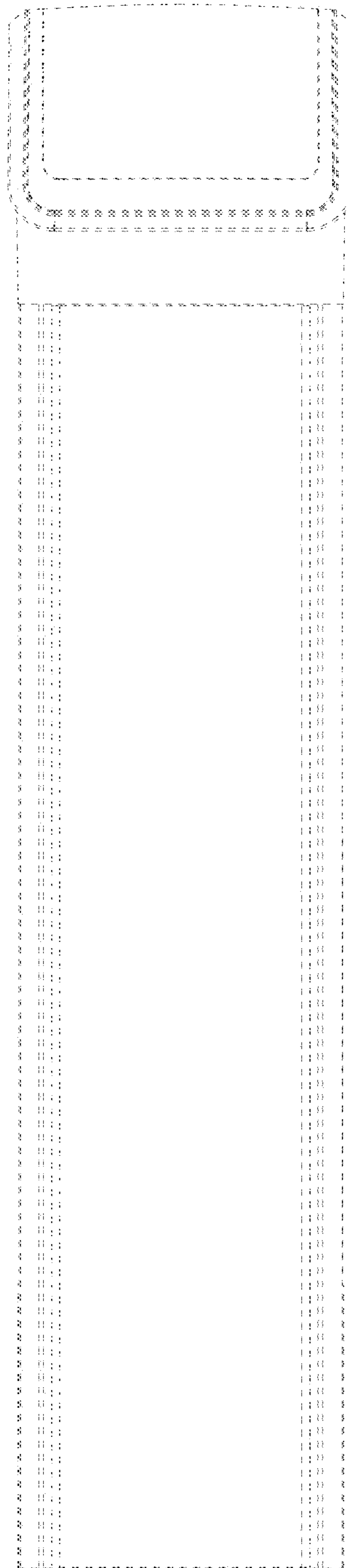

FIG. 4

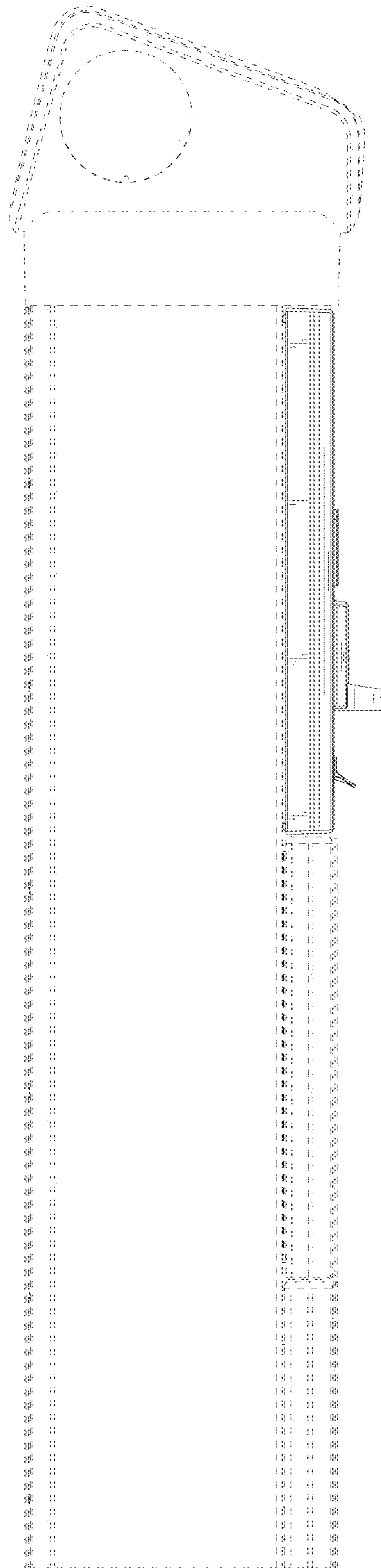

FIG. 5

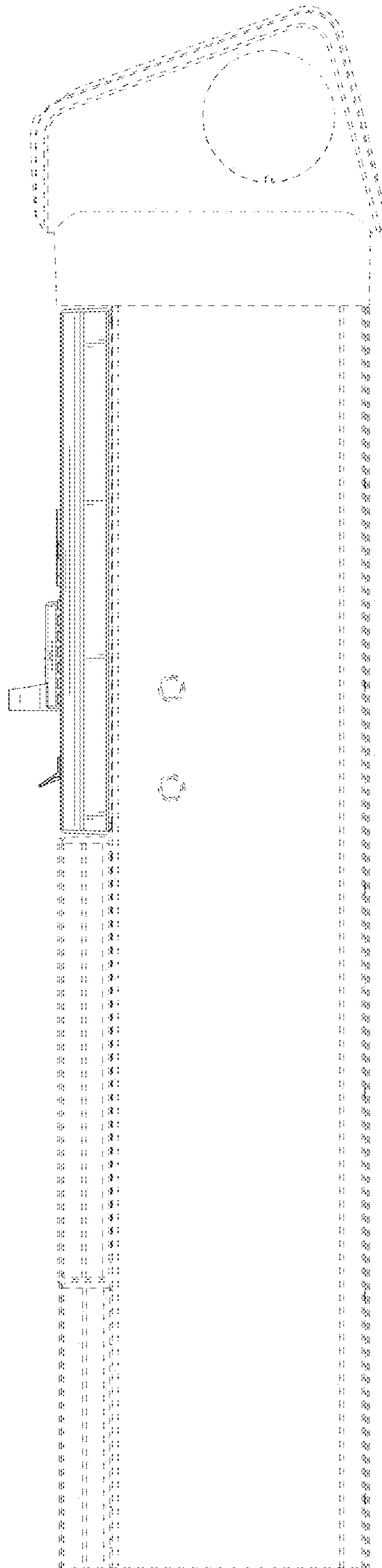

FIG. 6

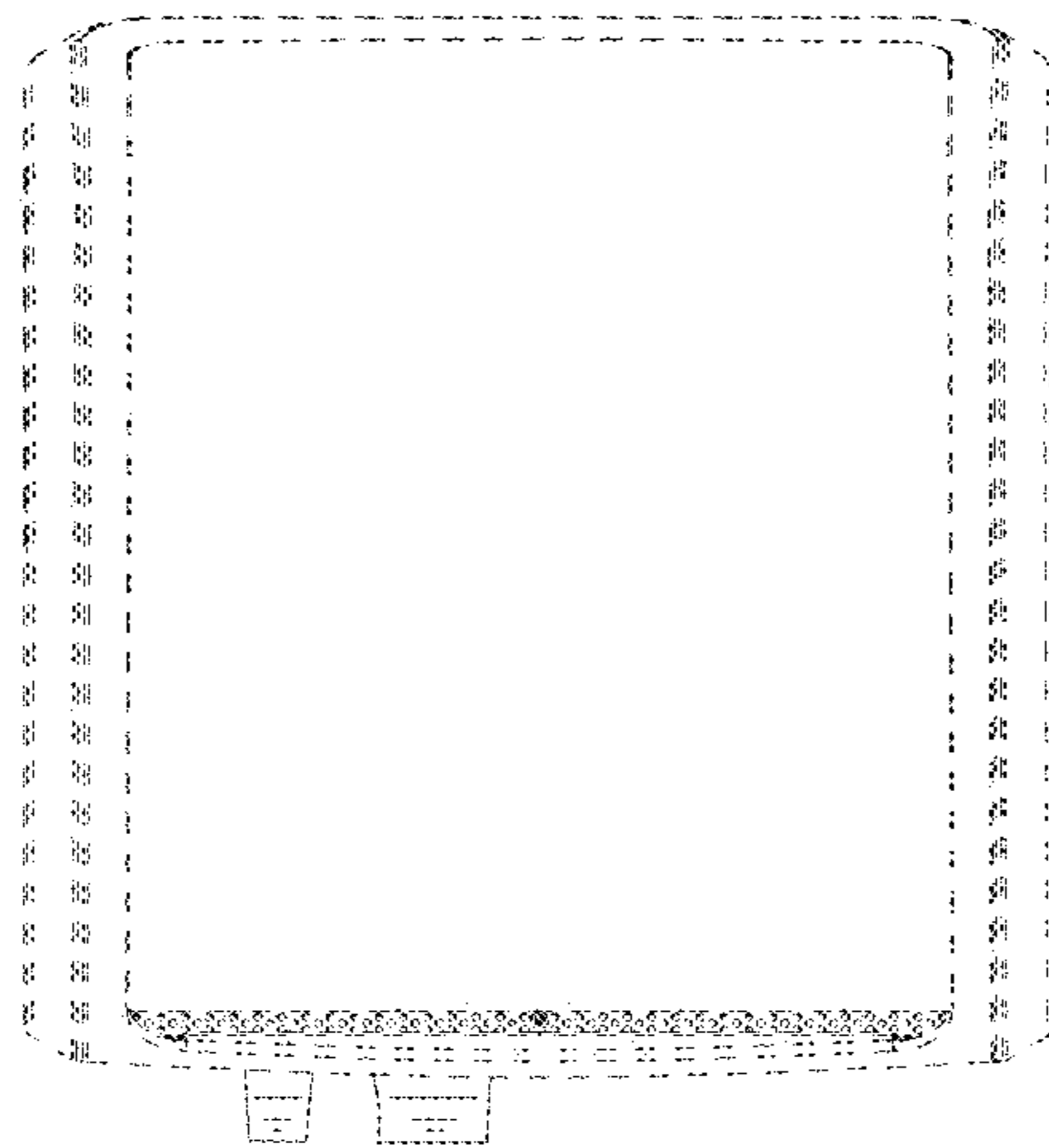

FIG. 7