



US00D970982S

(12) **United States Design Patent** (10) **Patent No.:** **US D970,982 S**  
**Ren** (45) **Date of Patent:** **\*\* Nov. 29, 2022**

(54) **BUTTER KNIFE**

(71) Applicant: **Song Ren**, Xuzhou (CN)

(72) Inventor: **Song Ren**, Xuzhou (CN)

(\*\*) Term: **15 Years**

(21) Appl. No.: **29/831,378**

(22) Filed: **Mar. 18, 2022**

(51) **LOC (13) Cl.** ..... **07-03**

(52) **U.S. Cl.**

USPC ..... **D7/649**; D7/401.2

(58) **Field of Classification Search**

USPC ..... D7/393–395, 401.2, 642–652, 664, 693,  
D7/695–696; D8/10, 93, 97–100, 107,  
D8/300, 321; D22/117–118, 149

CPC ..... A01B 1/20; A01B 1/22; A22C 25/006;  
A22C 25/025; A47G 21/005; A47G  
21/06; A47G 21/065; A61B 17/3211;  
A61B 17/3213; B21D 53/64; B25G 3/36;  
B26B 1/00; B26B 1/08; B26B 1/10;  
B26B 3/00; B26B 3/02; B26B 3/03;  
B26B 3/04; B26B 3/06; B26B 3/08;  
B26B 5/00; B26B 5/001; B26B 5/007;  
B26B 7/00; B26B 7/005; B26B 9/00;  
B26B 9/02; B26B 11/00; B26B 11/006;  
B26B 17/00; B26B 17/006; B26B 29/02

See application file for complete search history.

(56) **References Cited**

**U.S. PATENT DOCUMENTS**

1,426,085 A \* 8/1922 Kohn ..... A47G 21/005  
D7/688  
2,435,351 A \* 2/1948 Hay ..... A22C 25/025  
452/103  
D457,220 S \* 5/2002 Huckaba ..... D22/149  
D581,730 S \* 12/2008 Epstein ..... D7/401.2

D583,632 S \* 12/2008 Qualtieri ..... D7/650  
D692,731 S \* 11/2013 Solari ..... D7/649  
D696,083 S \* 12/2013 Hollinger ..... D7/649  
D766,670 S \* 9/2016 Delgado Carmona ..... D7/649  
D774,846 S 12/2016 Pantschenko et al.  
D822,444 S \* 7/2018 McGuyer ..... D7/669  
10,369,710 B2 \* 8/2019 Myvett ..... B26B 11/006  
D875,484 S \* 2/2020 Workman ..... D7/650  
D917,984 S \* 5/2021 Wang ..... D7/649

**OTHER PUBLICATIONS**

Elifana Butter Knife Spreader. Date First Available on Amazon.com  
Jul. 28, 2020. <https://www.amazon.com/dp/B08Z3KXKSH/ref> (Year:  
2020).\*

\* cited by examiner

*Primary Examiner* — Ricky Pham

(57) **CLAIM**

The ornamental design for a butter knife, as shown and  
described.

**DESCRIPTION**

FIG. 1 is a front and top perspective view of a butter knife,  
showing my new design;  
FIG. 2 is a front elevation view thereof;  
FIG. 3 is a rear elevation view thereof;  
FIG. 4 is a left side elevation view thereof;  
FIG. 5 is a right side elevation view thereof;  
FIG. 6 is a top plan view thereof;  
FIG. 7 is a bottom plan view thereof; and,  
FIG. 8 is an enlarged view of a portion labeled, 'FIG. 8' in  
FIG. 1.

The dash dot dash lines in FIGS. 1 and 8 are for the purpose  
of depicting the boundary lines of the enlarged view and  
form no part of the claimed design.

**1 Claim, 8 Drawing Sheets**

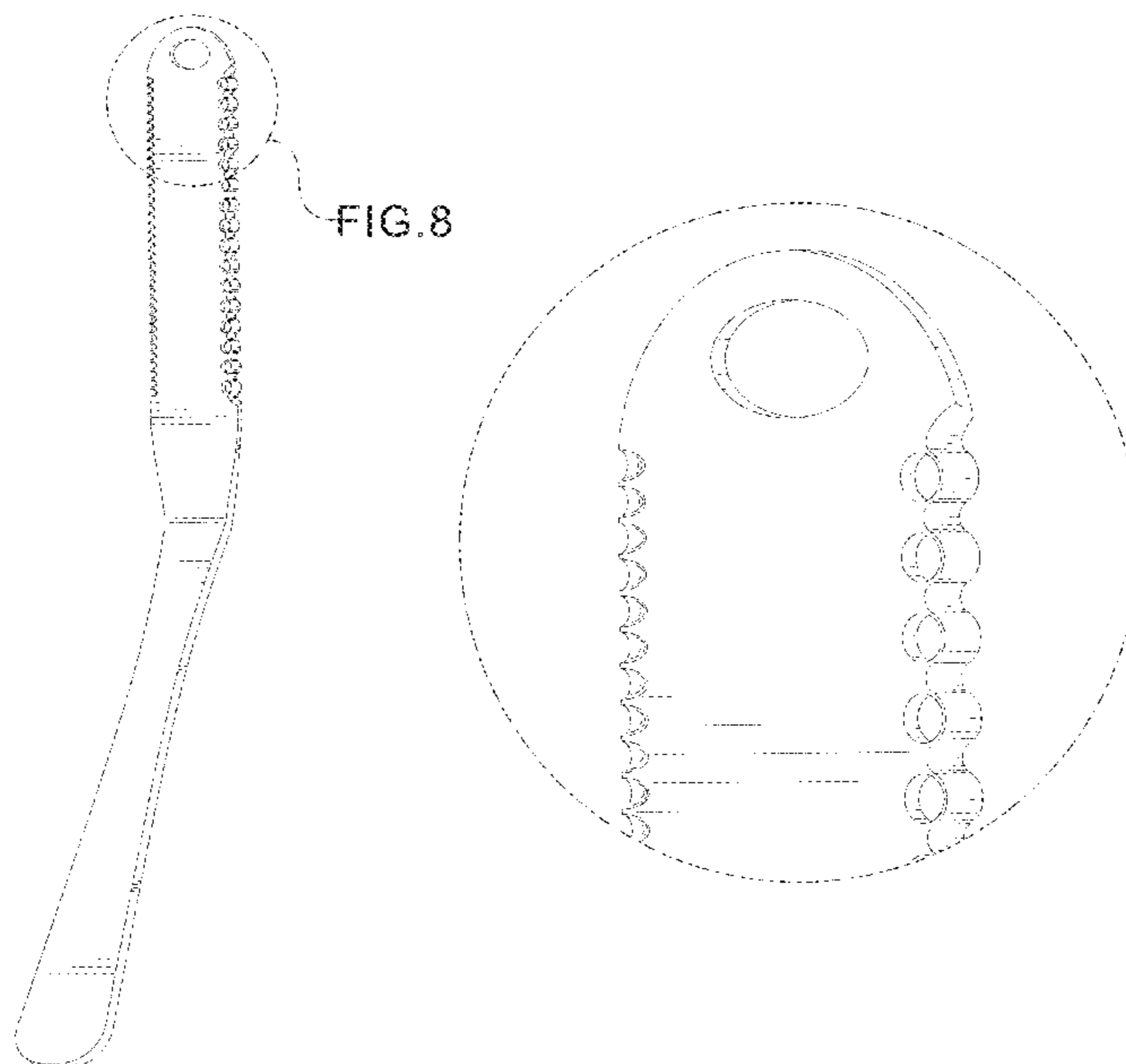

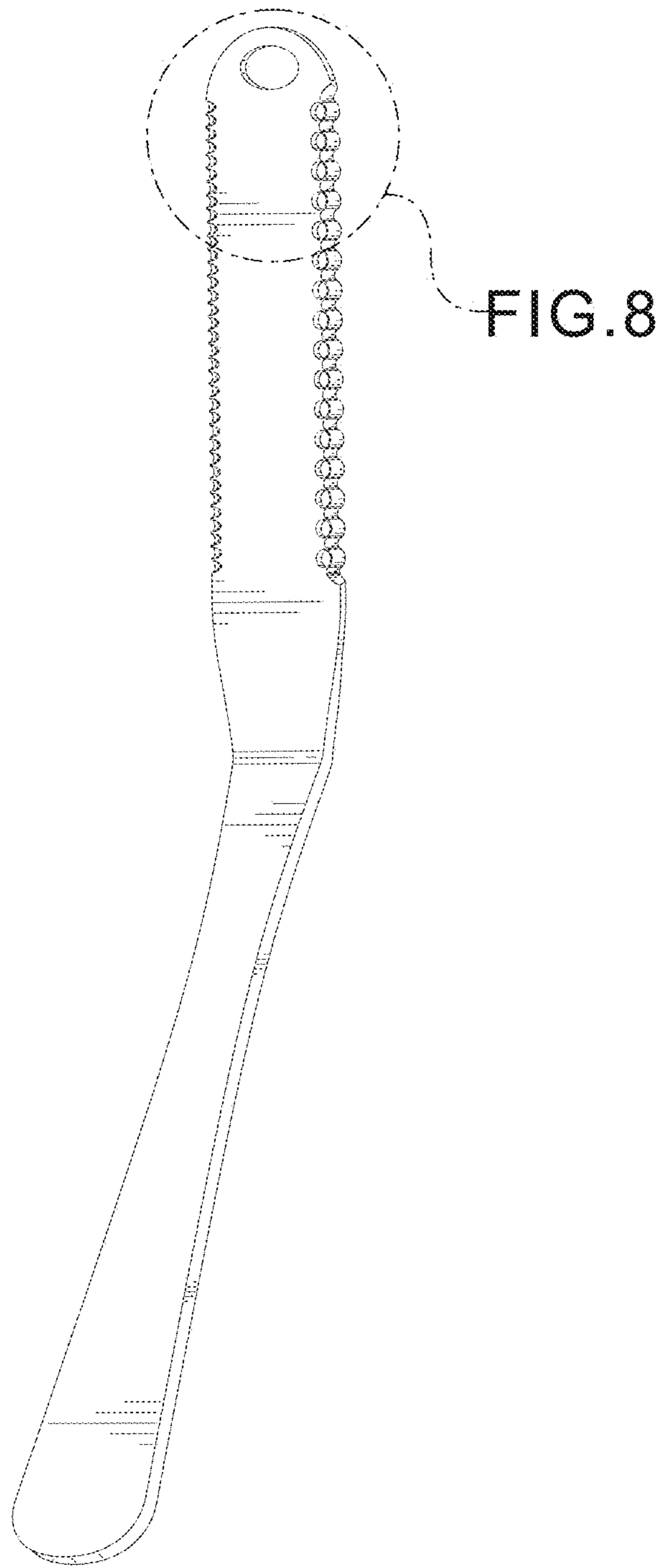

FIG. 1

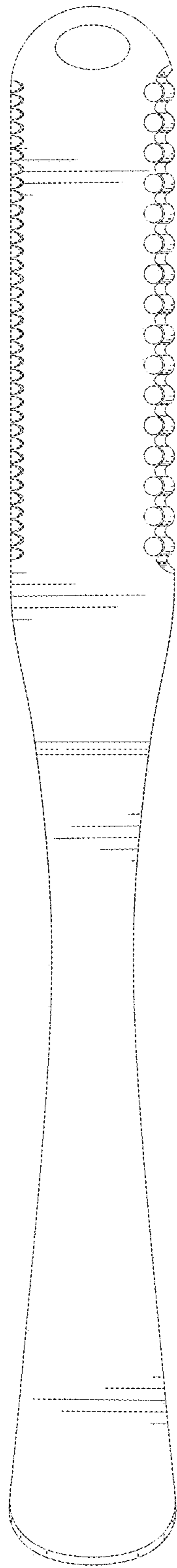

FIG. 2

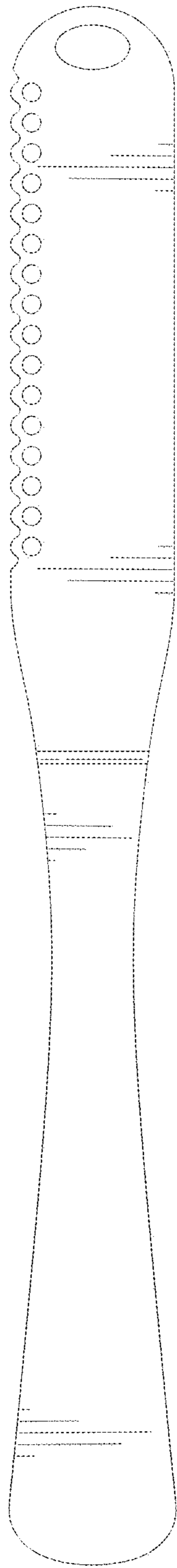

FIG. 3

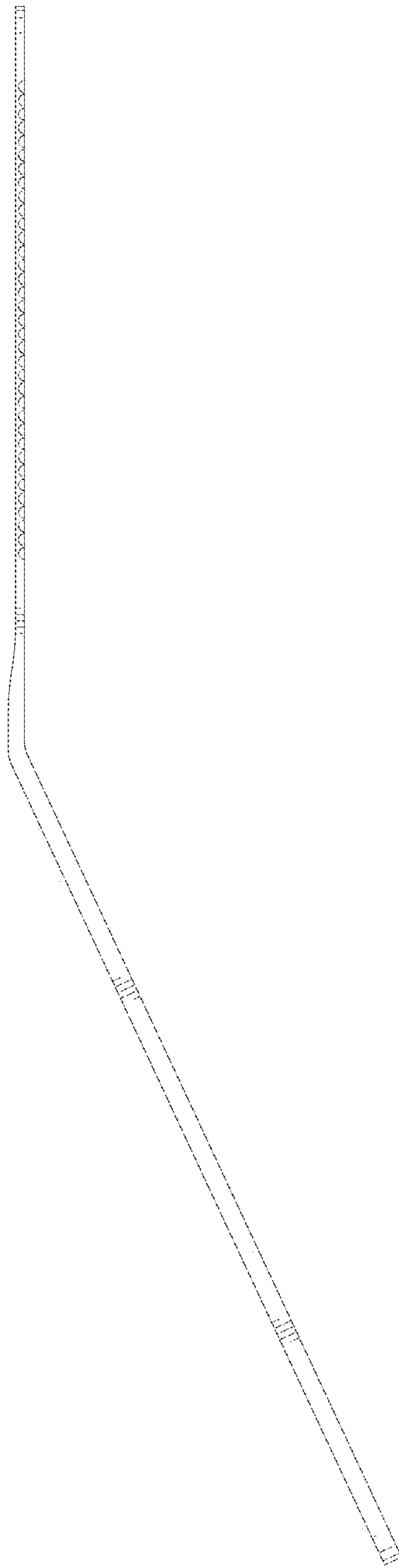

FIG. 4

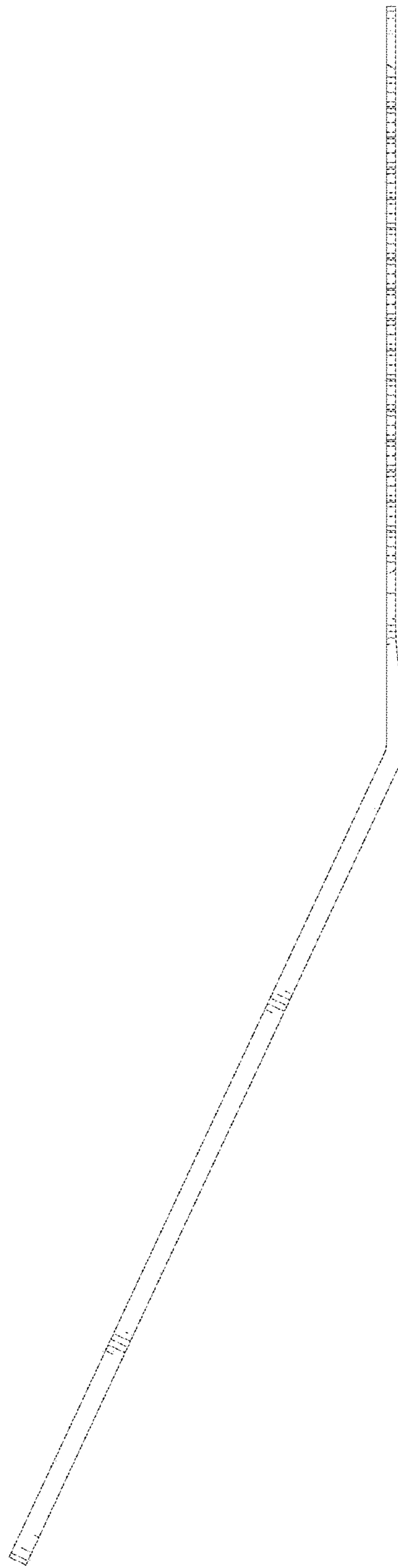

FIG. 5

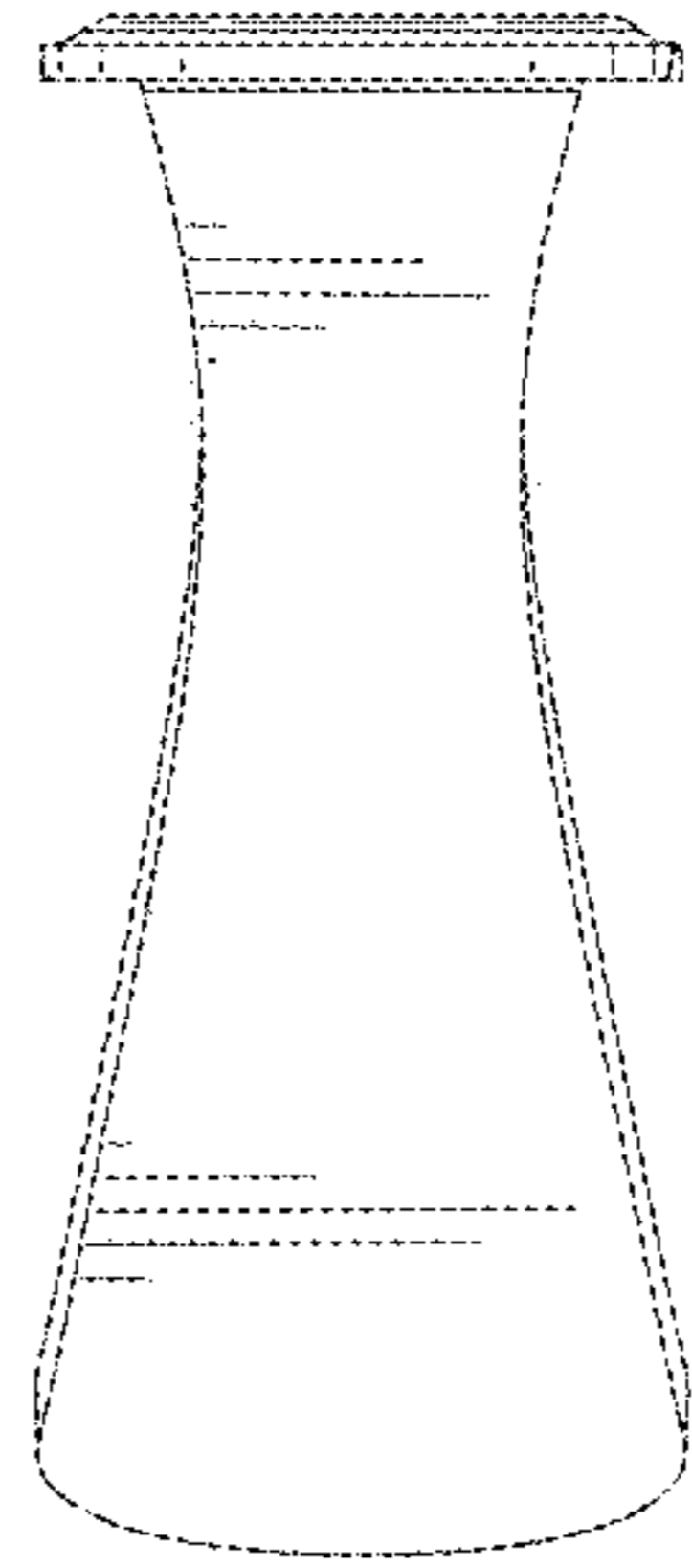

FIG. 6

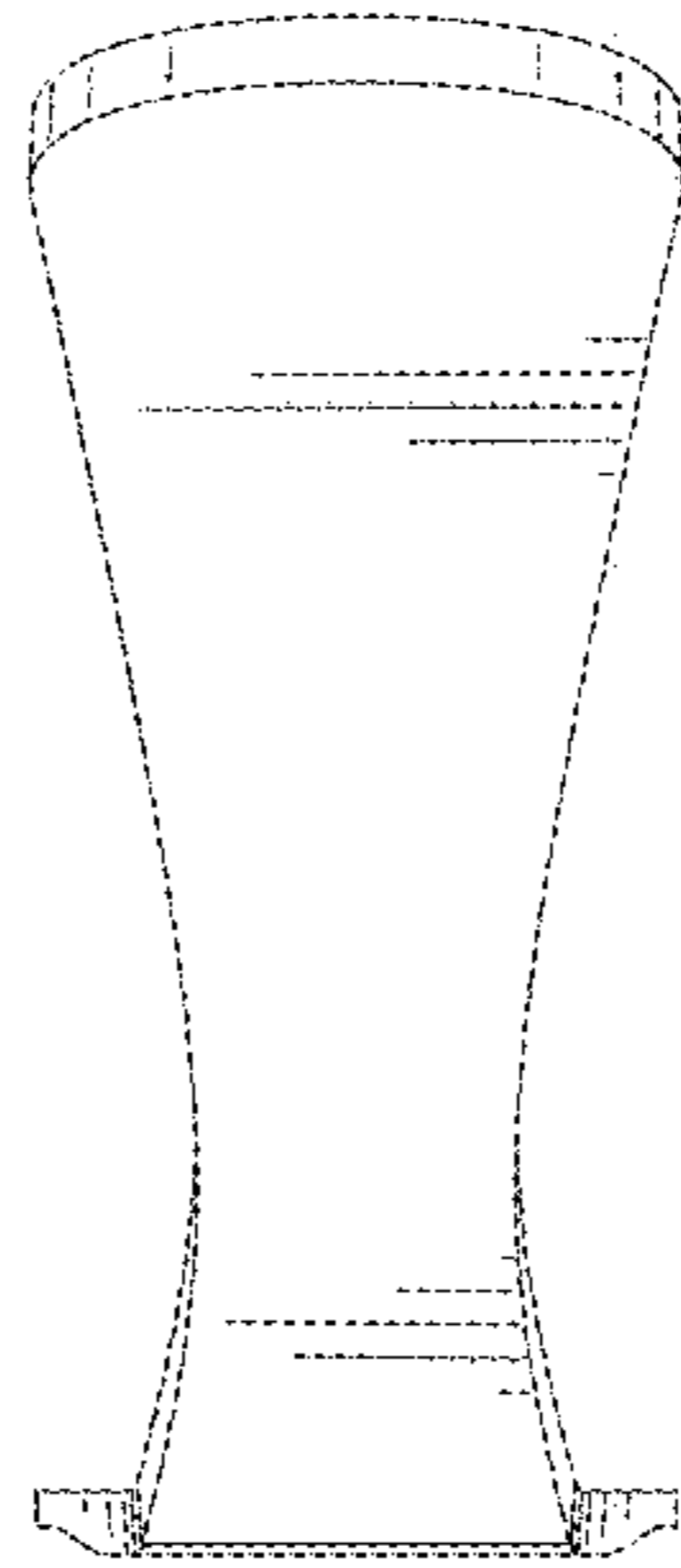

FIG. 7



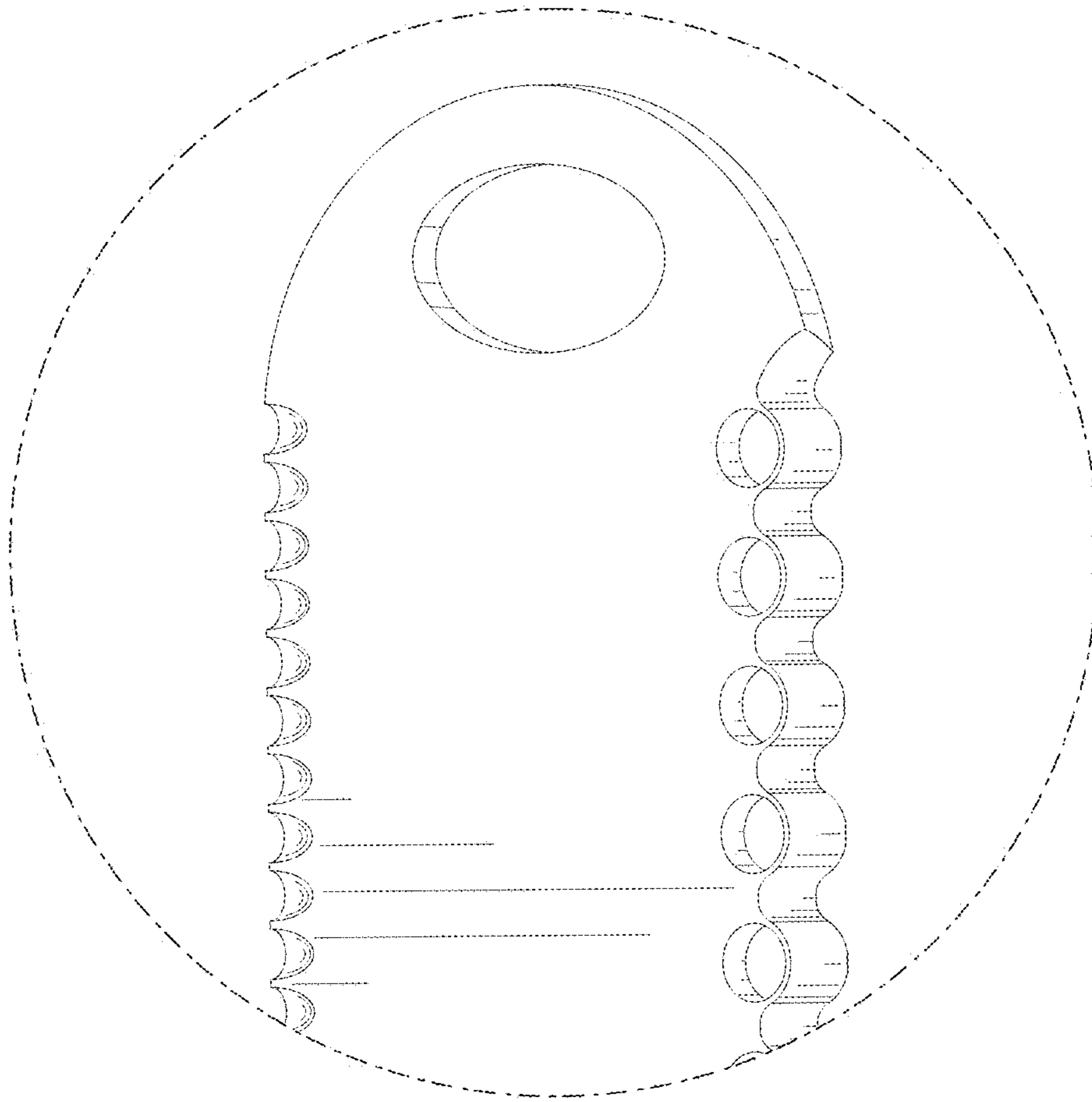

FIG. 8