

US00D970956S

(12) **United States Design Patent**  
**Moretti**

(10) **Patent No.:** **US D970,956 S**

(45) **Date of Patent:** **\*\* Nov. 29, 2022**

(54) **OVEN COOKING**

(71) Applicant: **MORETTI FORNI S.P.A.**, Mondolfo (IT)

(72) Inventor: **Mario Moretti**, Pesaro (IT)

(\*\*) Term: **15 Years**

(21) Appl. No.: **35/513,009**

(22) Filed: **Oct. 29, 2021**

(80) **Hague Agreement Data**

Int. Filing Date: **Oct. 29, 2021**

Int. Reg. No.: **DM/217463**

Int. Reg. Date: **Oct. 29, 2021**

Int. Reg. Pub. Date: **Nov. 26, 2021**

(51) **LOC (13) Cl.** ..... **07-02**

(52) **U.S. Cl.**  
USPC ..... **D7/339**

(58) **Field of Classification Search**

USPC ..... D7/323, 328-334, 339-349, 390, D7/402-406; D8/300-306

CPC . A21B 2/00; A47J 37/00; A47J 37/042; A47J 37/06; A47J 37/0611; A47J 37/0623; A47J 37/0704; A47J 37/0754; A47J 37/079; A47J 37/08; A47J 37/0807; A47J 37/0814; A47J 37/0835; A47J 37/0842; A47J 37/085; A47J 37/0864; A47J 37/0878; A47J 37/0885; A47J 37/0892; F24B 1/202; F24C 7/00; F24C 7/002; F24C 7/046; F24C 7/067; F24C 15/02; F24C 15/04; F24C 15/10; F24C 15/102

See application file for complete search history.

(56) **References Cited**

**U.S. PATENT DOCUMENTS**

1,796,033 A \* 3/1931 Lee ..... F24B 1/202 D7/332

4,510,854 A \* 4/1985 Robertson ..... A47J 37/042 99/481

D493,328 S \* 7/2004 Wood ..... D7/332  
D637,860 S \* 5/2011 Petty ..... D7/333  
8,490,614 B1 \* 7/2013 Gregory ..... A47J 37/0754 126/41 R  
8,833,360 B2 \* 9/2014 Knight ..... F24B 1/202 126/21 A  
D715,084 S \* 10/2014 Hill ..... D7/332  
D720,569 S \* 1/2015 Hill ..... D7/334  
9,351,607 B2 \* 5/2016 Pothetes ..... A47J 37/0704  
9,907,435 B2 \* 3/2018 Kohler ..... A47J 37/0623  
D842,636 S \* 3/2019 Nilssen ..... D7/332  
D942,796 S \* 2/2022 Jiang ..... D7/339  
2012/0073557 A1 \* 3/2012 Knight ..... A47J 37/079 126/19 R

\* cited by examiner

*Primary Examiner* — Ricky Pham

(57) **CLAIM**

The ornamental design for an oven (cooking), as shown and described.

**DESCRIPTION**

1. Oven (cooking)
  2. Oven (cooking)
    - 1.1 : Perspective
    - 1.2 : Front
    - 1.3 : Right
    - 1.4 : Back
    - 1.5 : Left
    - 1.6 : Top
    - 1.7 : Bottom
    - 2.1 : Perspective
    - 2.2 : Front
    - 2.3 : Right
    - 2.4 : Back
    - 2.5 : Left
    - 2.6 : Top
    - 2.7 : Bottom
- Modular cooking oven of the electrical type.

**1 Claim, 14 Drawing Sheets**

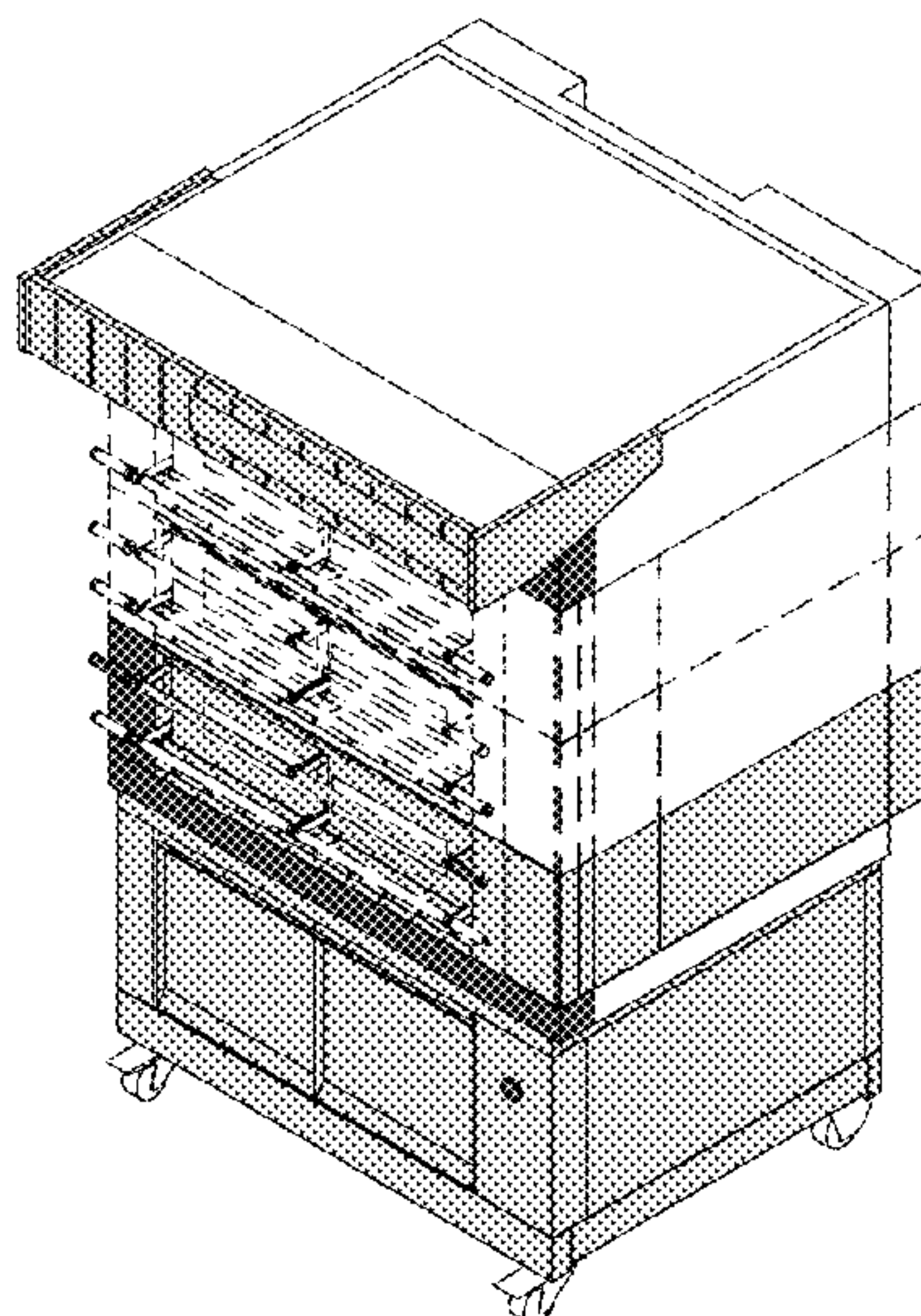

1.1

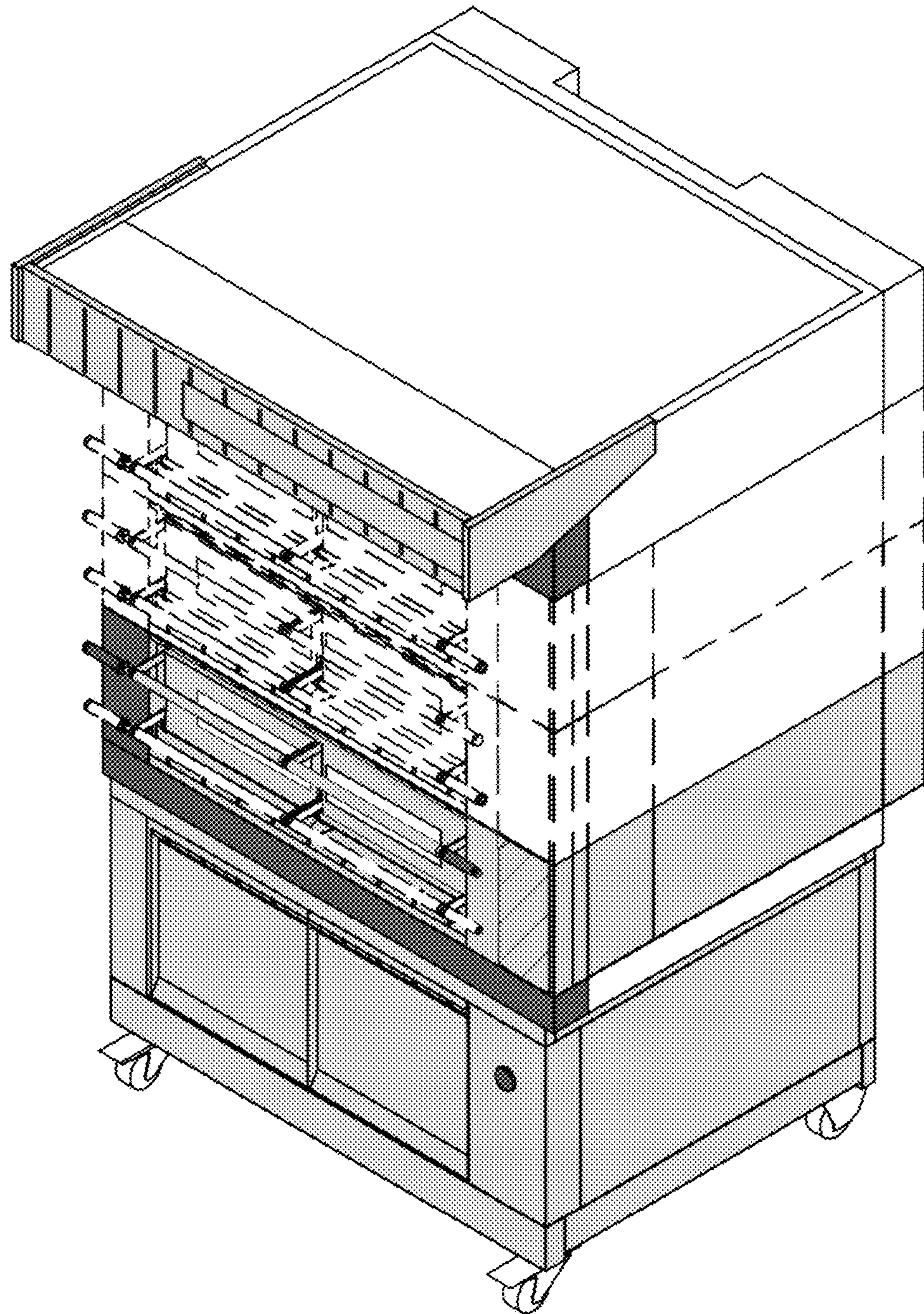



1.2

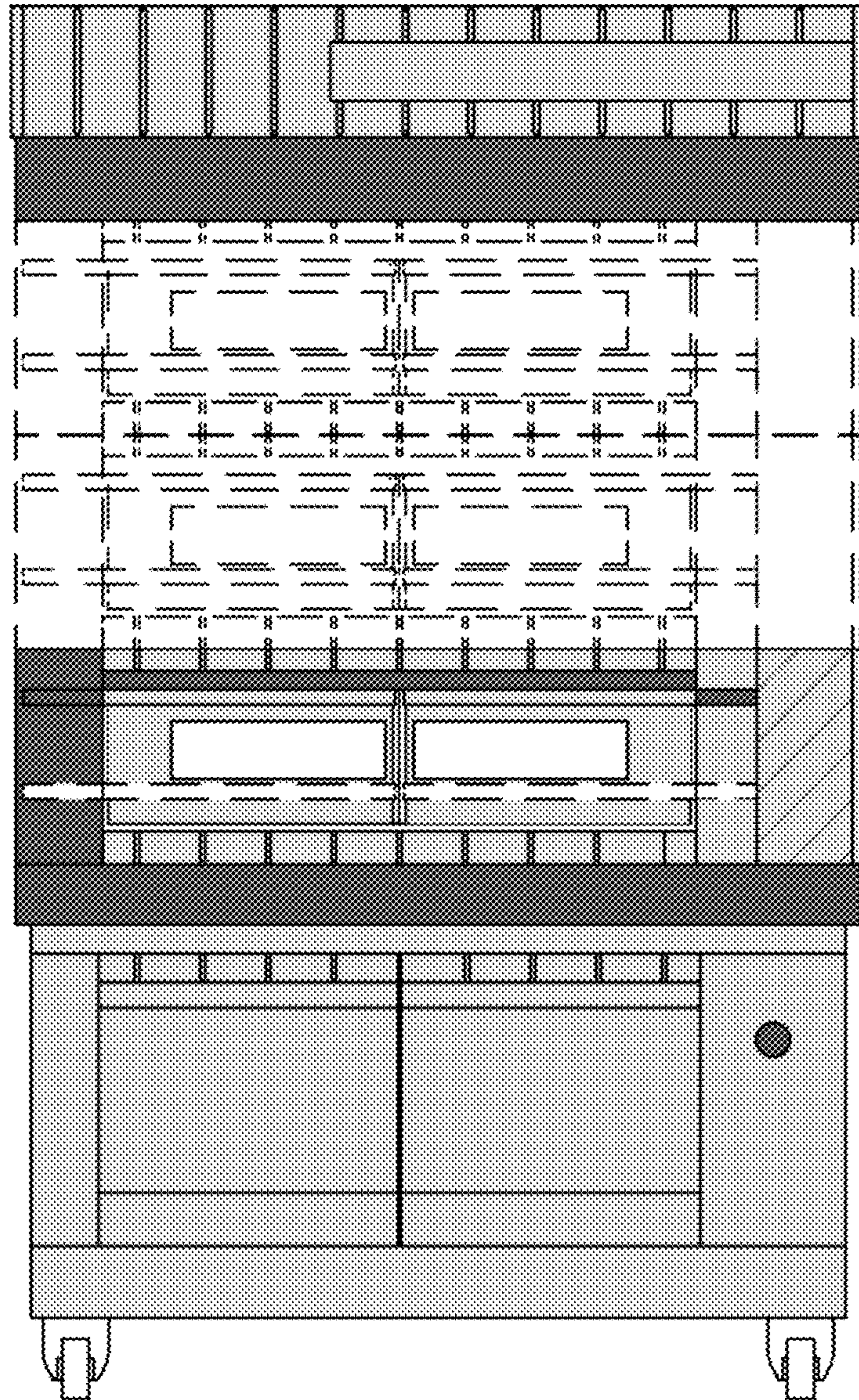

1.3

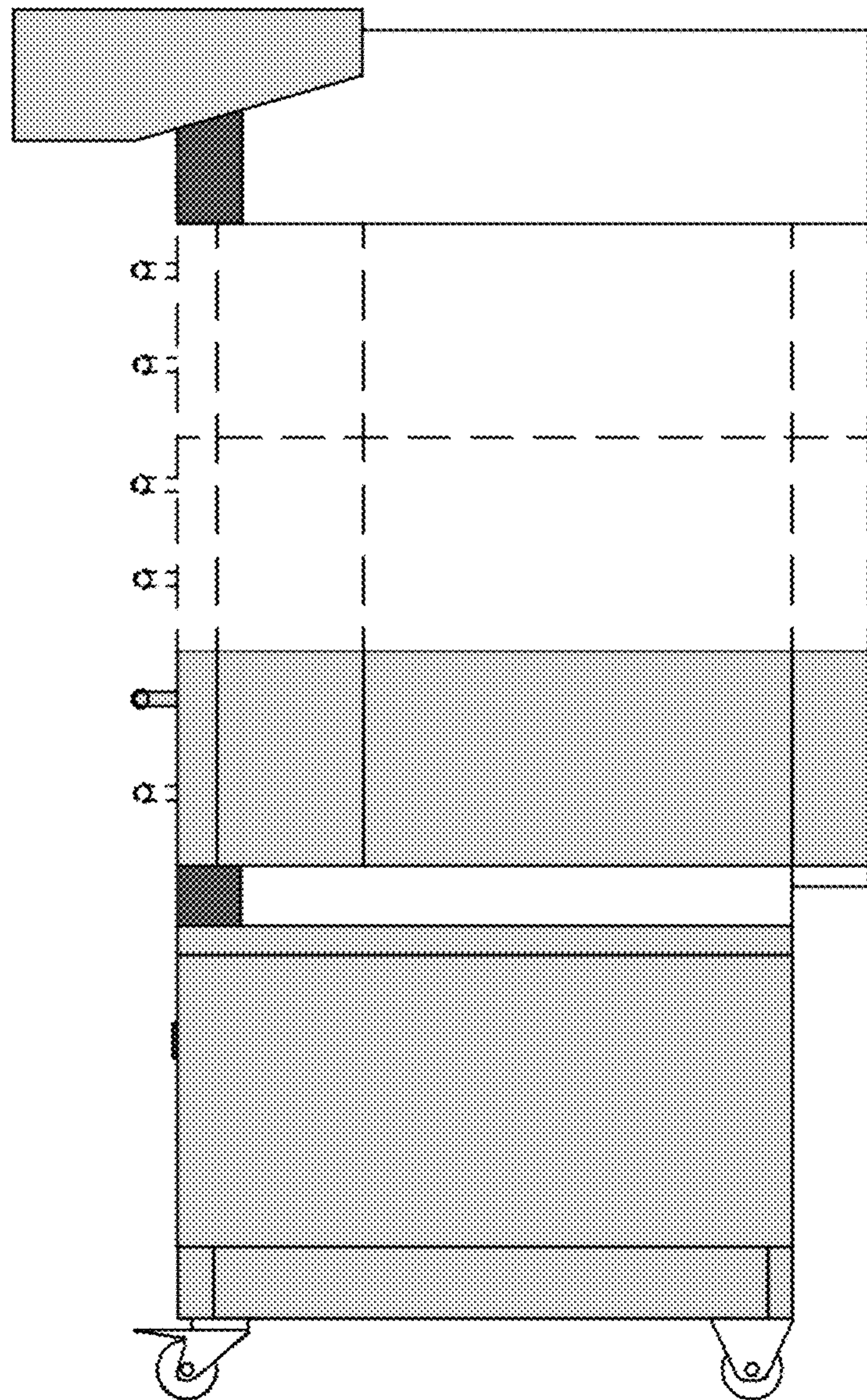



1.4

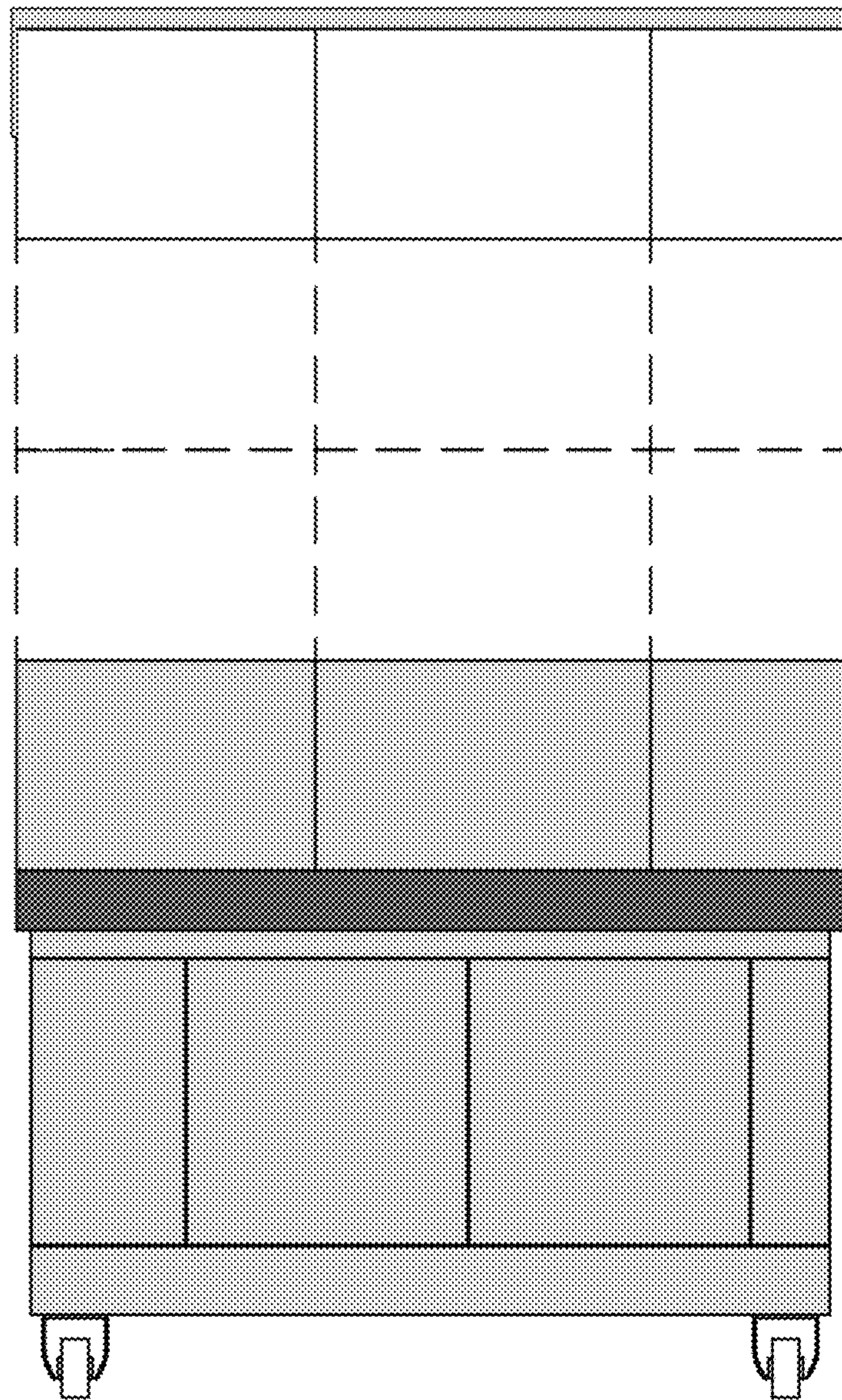

1.5

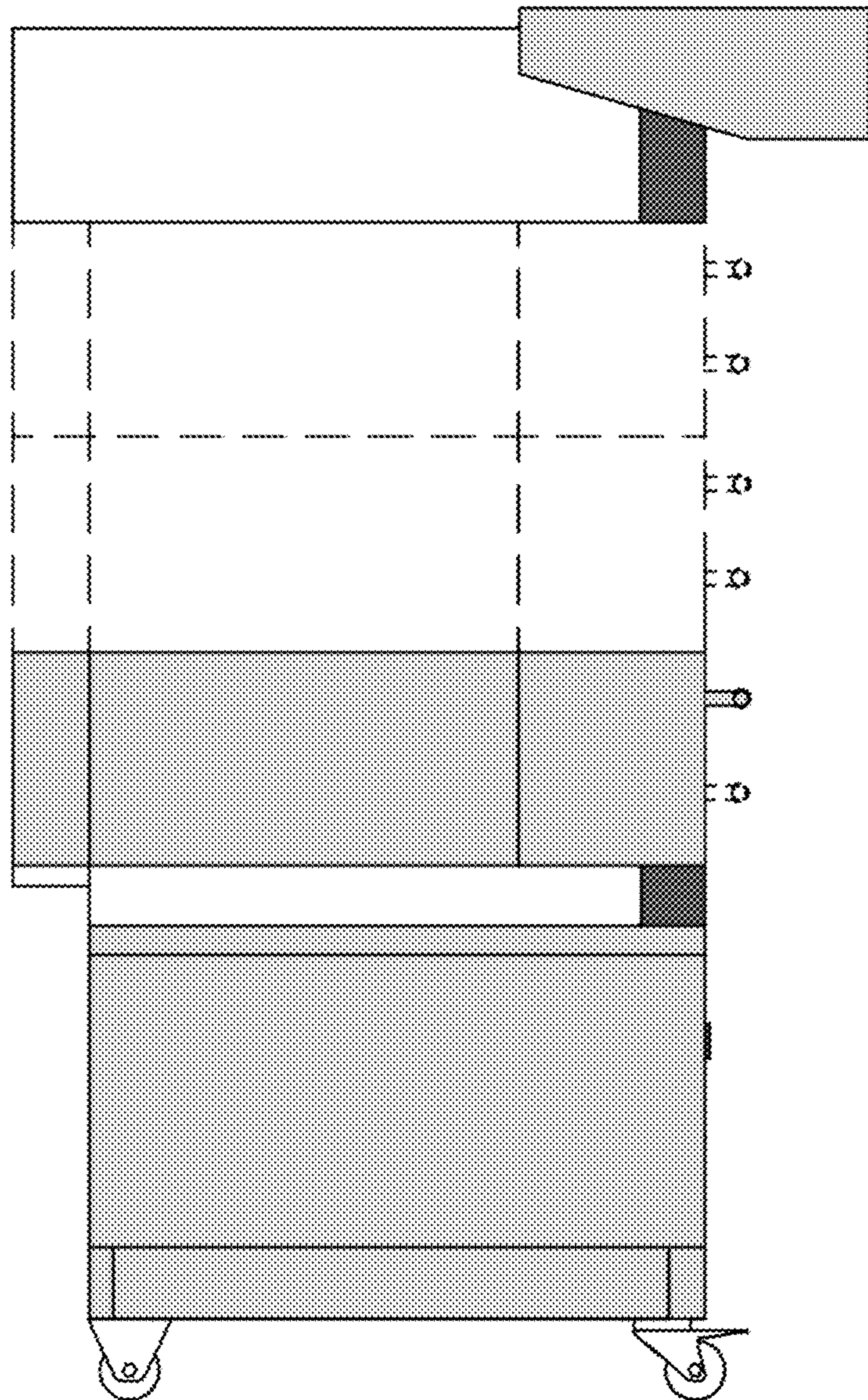

1.6

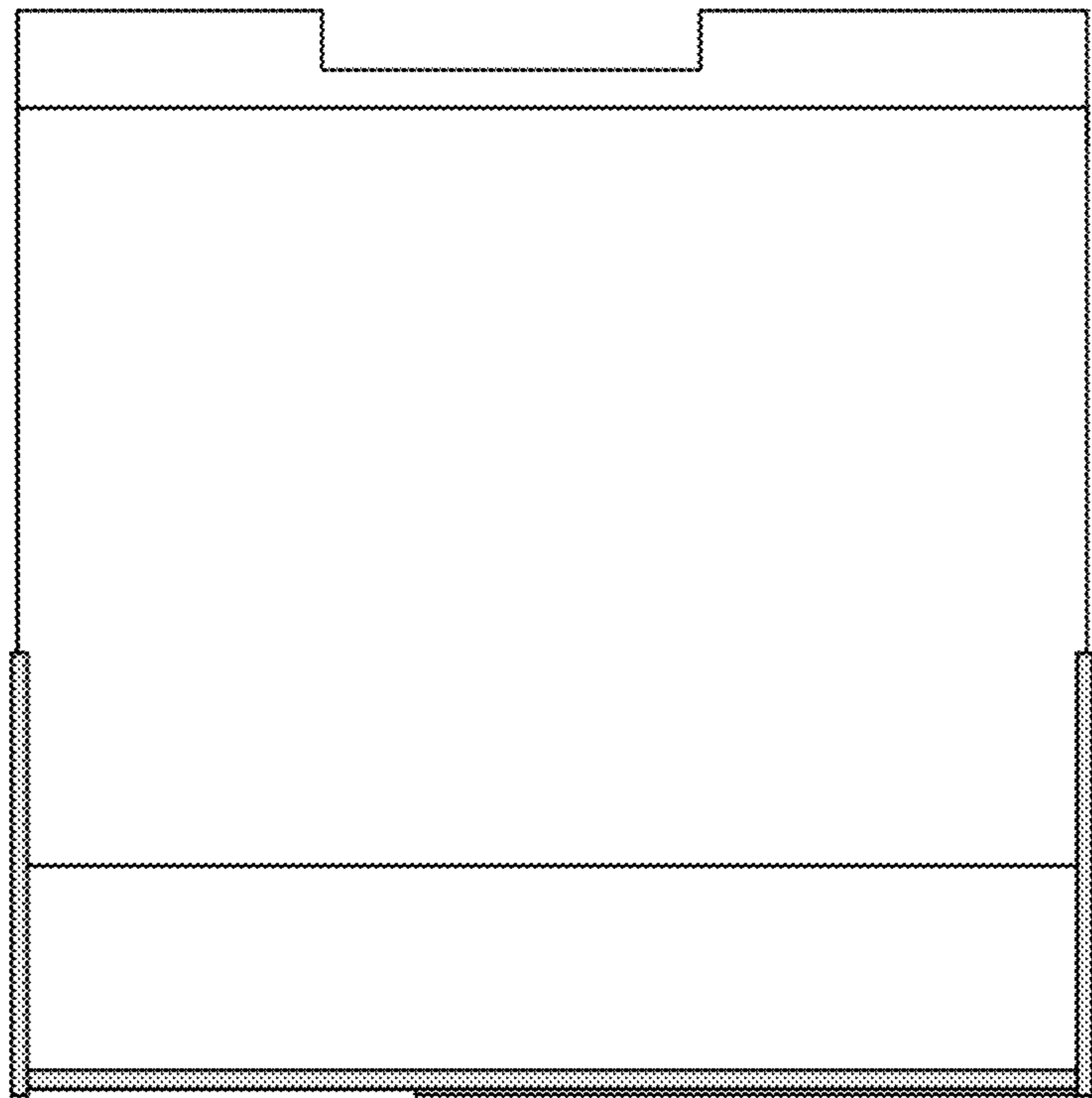

1.7

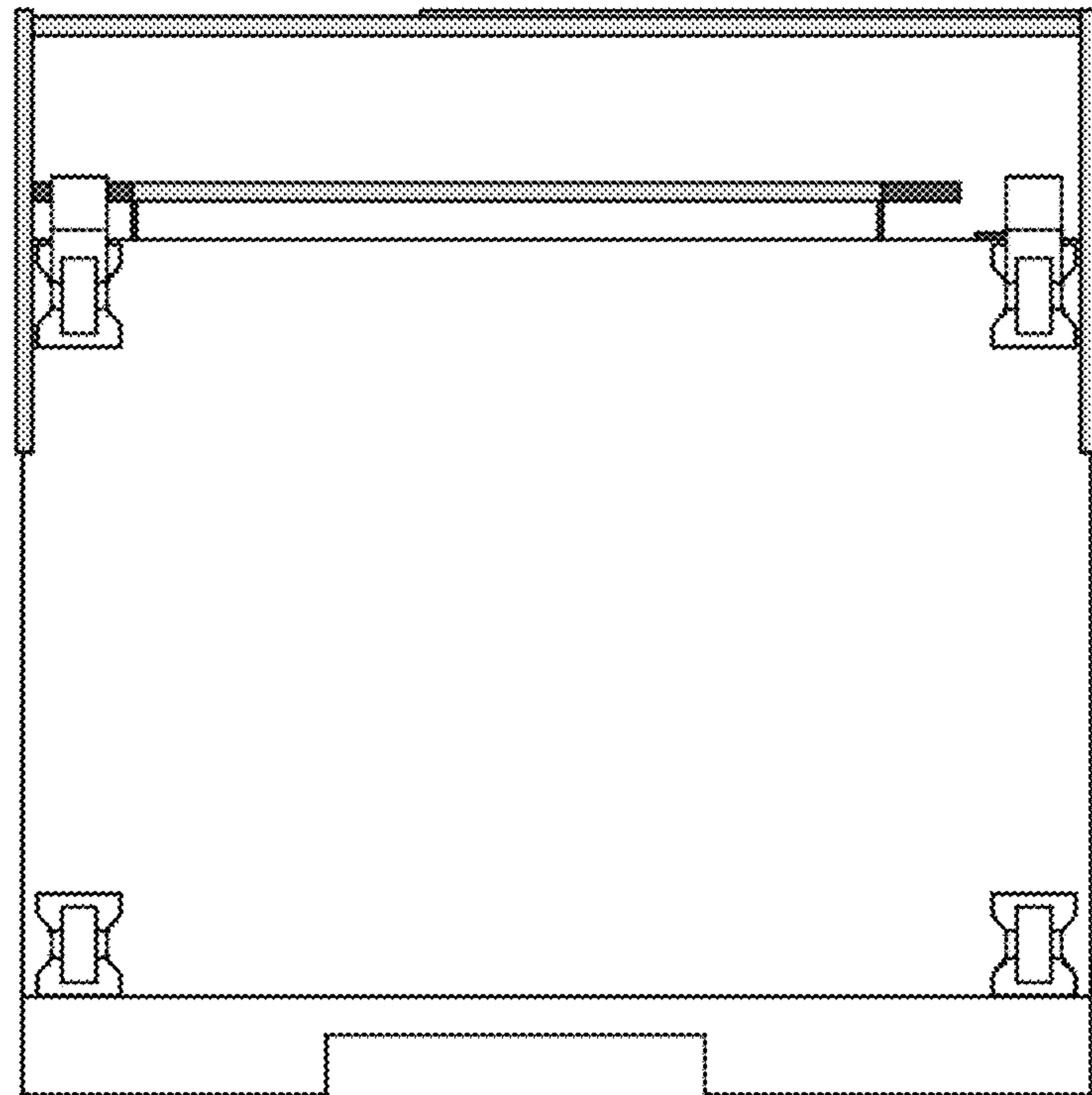



2.1

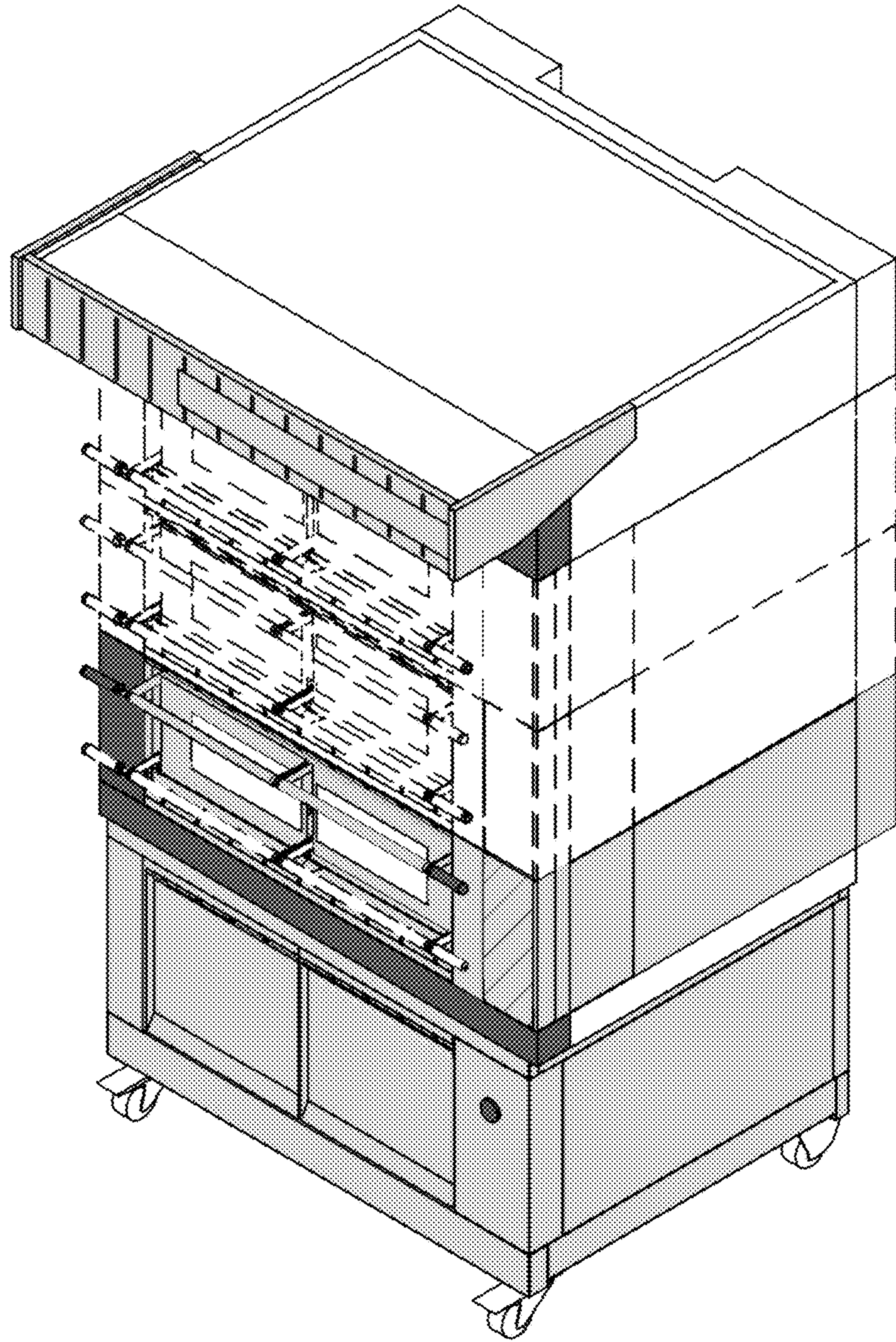



2.2

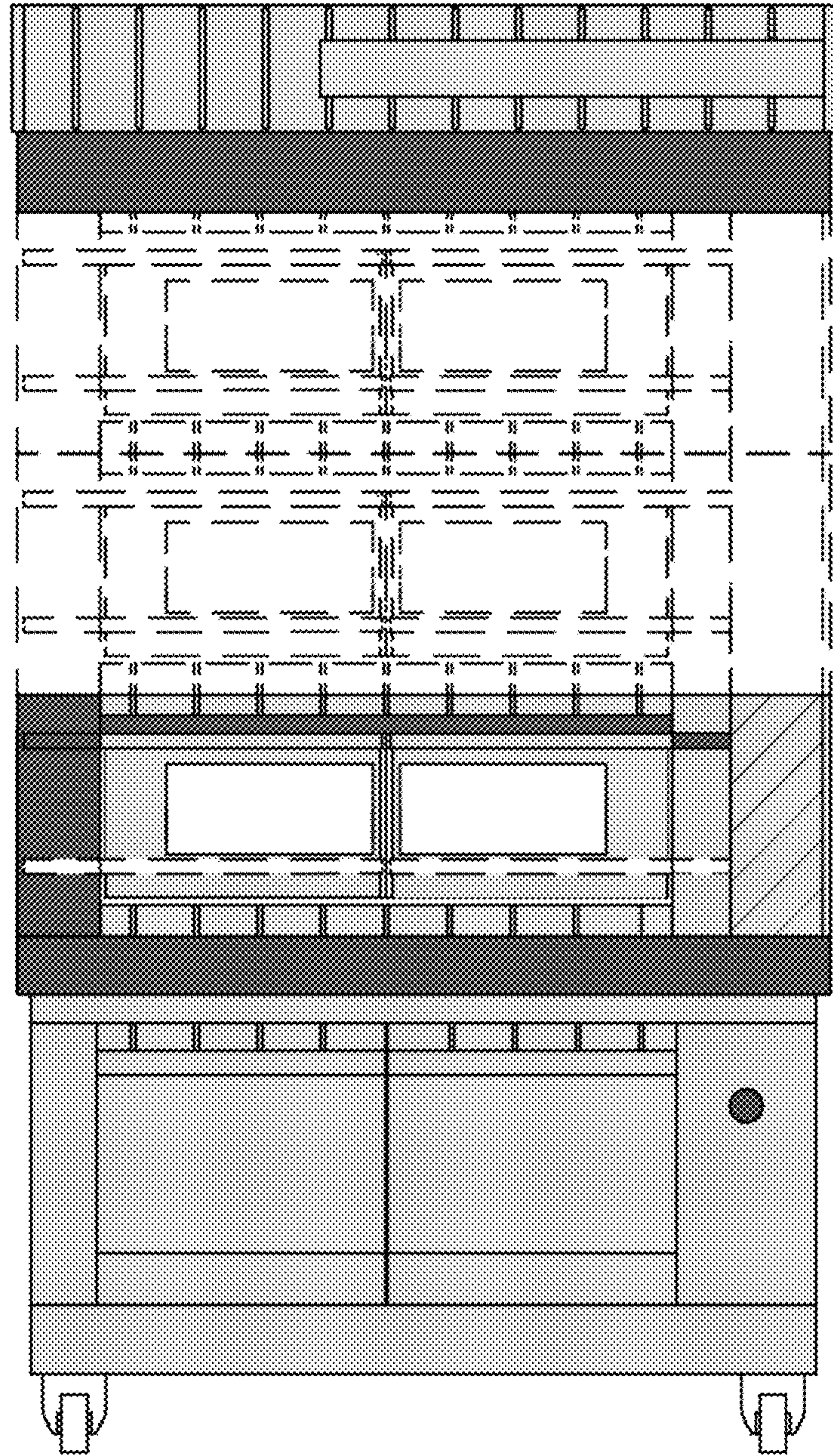

2.3

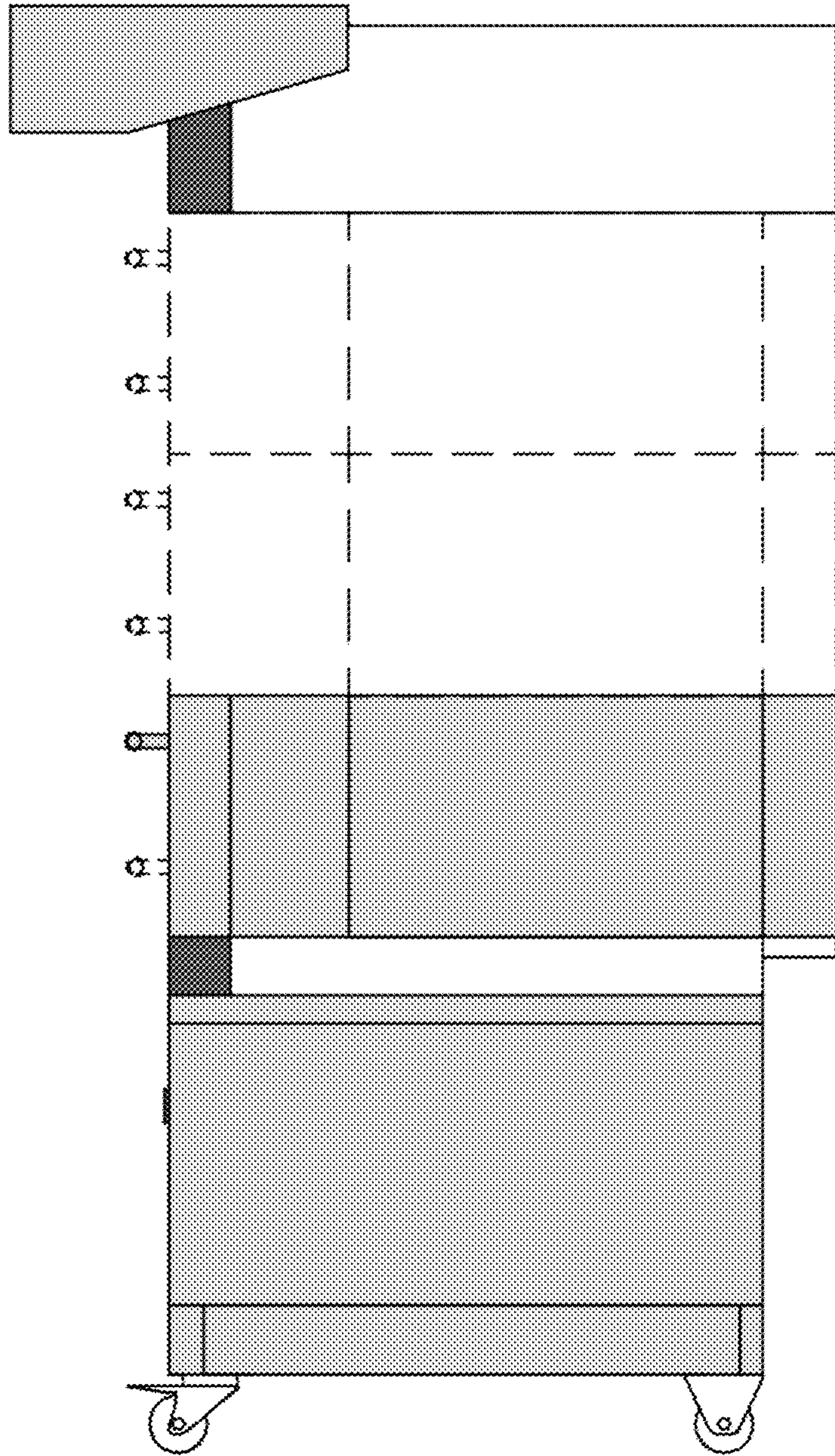



2.4

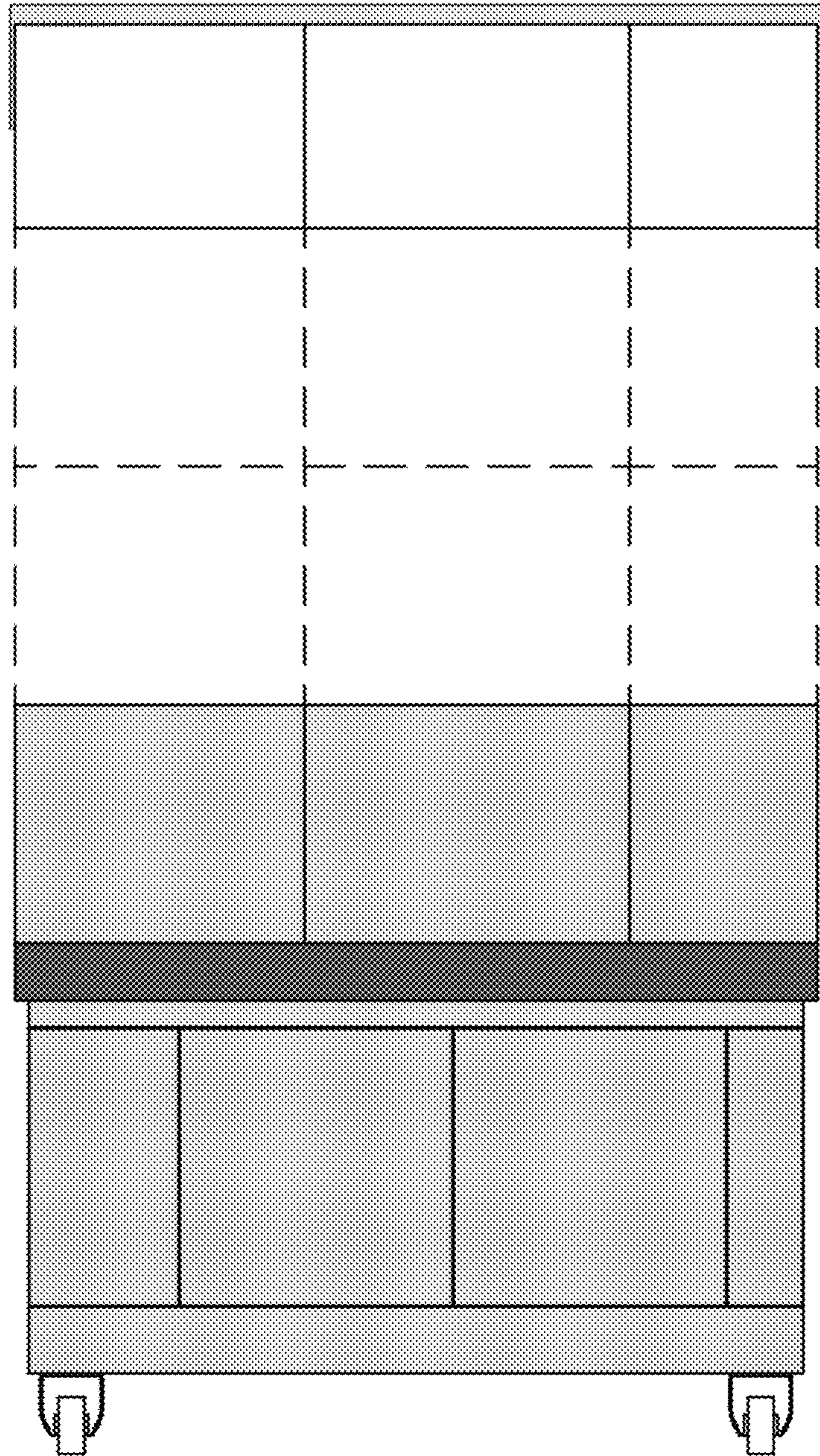

2.5

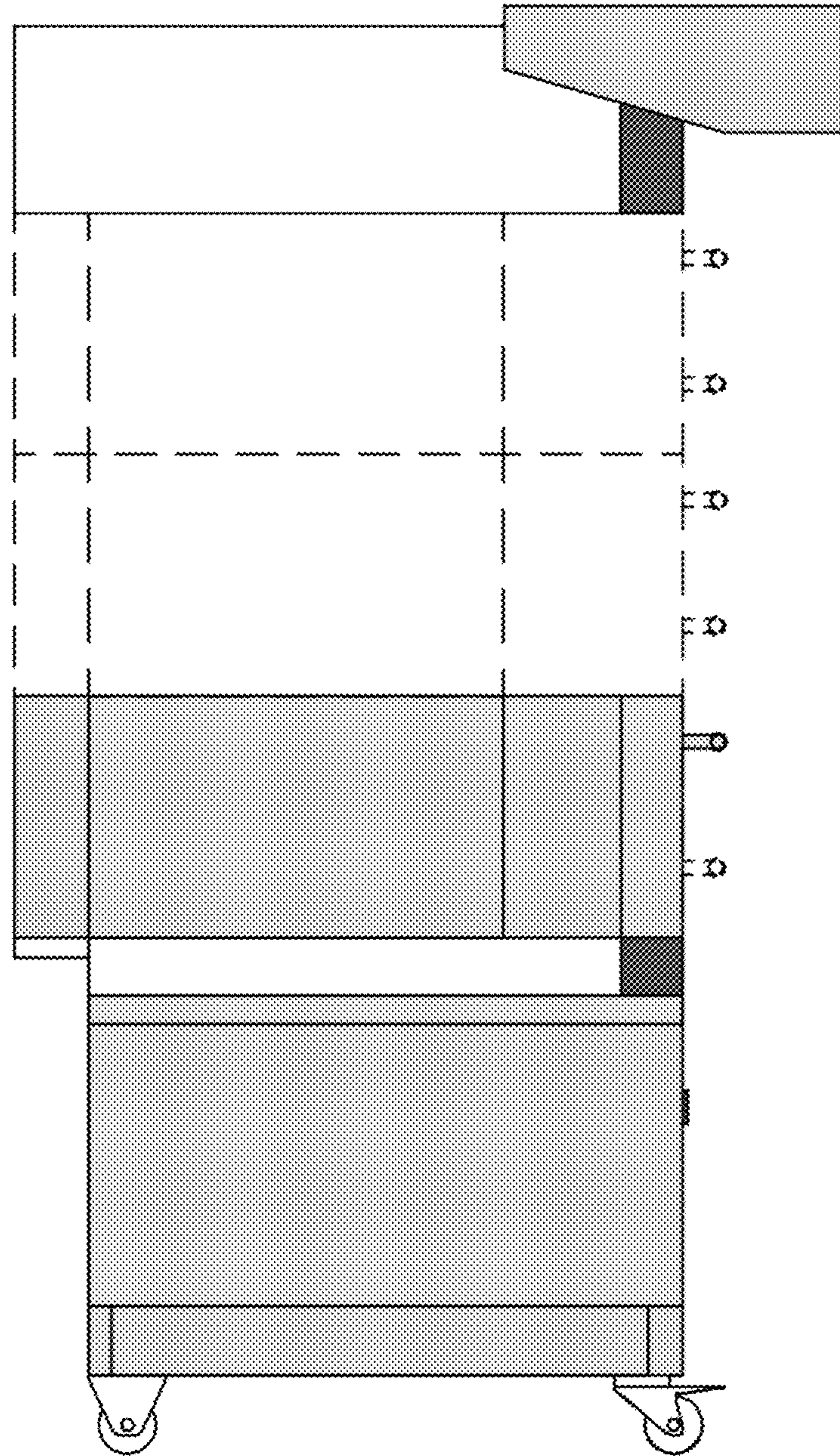

2.6

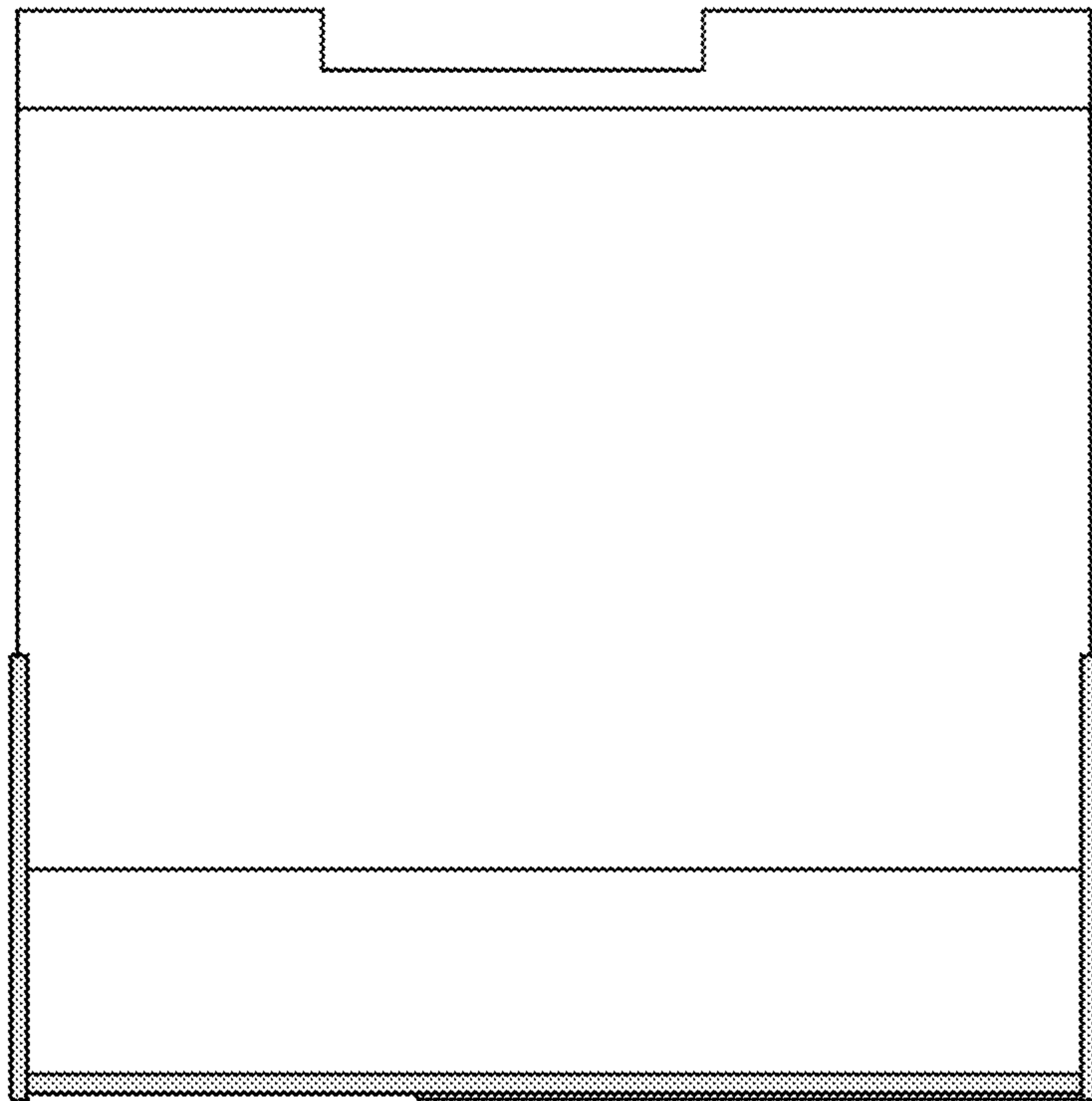



2.7

