



US00D970908S

(12) **United States Design Patent**  
**Liang**

(10) **Patent No.:** **US D970,908 S**

(45) **Date of Patent:** **\*\* Nov. 29, 2022**

- (54) **TOWEL HOOK**
- (71) Applicant: **Guangzhou Dihe Technology Co., LTD.**, Guangzhou (CN)
- (72) Inventor: **Meiling Liang**, Luoding (CN)
- (73) Assignee: **Guangzhou Dihe Technology Co., LTD.**, Guangzhou (CN)
- (\*\*) Term: **15 Years**
- (21) Appl. No.: **29/828,193**
- (22) Filed: **Feb. 24, 2022**
- (51) **LOC (13) Cl.** ..... **06-08**
- (52) **U.S. Cl.**  
USPC ..... **D6/323**
- (58) **Field of Classification Search**  
USPC ..... D6/315, 317-320, 323, 326, 328, 672;  
D8/367, 372, 373, 380  
CPC ..... A47G 1/00; A47G 25/00; A47G 25/06;  
A47G 25/10; A47G 25/28; A47G 25/30;  
A47G 25/32; A47G 25/68  
See application file for complete search history.

- D839,721 S \* 2/2019 Downey ..... D8/367
- D867,771 S 11/2019 Zhong
- D887,254 S \* 6/2020 Bond ..... D8/367
- D906,097 S \* 12/2020 Krull ..... D8/367
- D935,312 S \* 11/2021 Zhou ..... D8/367

**OTHER PUBLICATIONS**

Taozun Adhesive Hook, available in Amazon.com.uk, first available date of Aug. 22, 2021, site visited on Jul. 27, 2022, URL:https://www.amazon.co.uk/Taozun-Adhesive-Hook-Sticky-Hooks/dp/B099WYSR3H?th=1 (Year: 2021).\*

Yigii Adhesive Towel Hooks, available in Amazon.com, first available date of Mar. 7, 2022, site visited on Jul. 20, 2022, URL:https://www.amazon.com/dp/B09TZXSXTXM/ (Year: 2022).\*

\* cited by examiner

*Primary Examiner* — Mary Ann Calabrese

*Assistant Examiner* — Mark David Wolfley

(74) *Attorney, Agent, or Firm* — ScienBiziP, P.C.

(57) **CLAIM**

The ornamental design for a towel hook, as shown and described.

(56) **References Cited**

**U.S. PATENT DOCUMENTS**

- D322,361 S \* 12/1991 Goodman ..... D8/367
- 6,789,773 B2 \* 9/2004 Holland ..... A47G 25/0607  
248/307
- D566,532 S \* 4/2008 Wolff ..... D8/367
- D761,093 S \* 7/2016 Liu ..... D8/367
- D767,907 S \* 10/2016 Goodman ..... D6/323
- D769,702 S \* 10/2016 Kuniyoshi ..... D8/367
- D811,201 S \* 2/2018 Berger ..... D8/367
- D811,862 S \* 3/2018 Berger ..... D8/367
- D812,453 S \* 3/2018 Berger ..... D8/367
- D812,454 S \* 3/2018 Berger ..... D8/367
- D821,184 S \* 6/2018 Berger ..... D8/367
- D839,632 S 2/2019 Downey et al.

**DESCRIPTION**

FIG. 1 is a front, right, top perspective view of a towel hook, showing my design.

FIG. 2 is a rear, left, bottom perspective view thereof.

FIG. 3 is a front elevation view thereof.

FIG. 4 is a rear elevation view thereof.

FIG. 5 is a left side elevation view thereof.

FIG. 6 is a right side elevation view thereof.

FIG. 7 is a top plan view thereof; and,

FIG. 8 is a bottom plan view thereof.

**1 Claim, 8 Drawing Sheets**

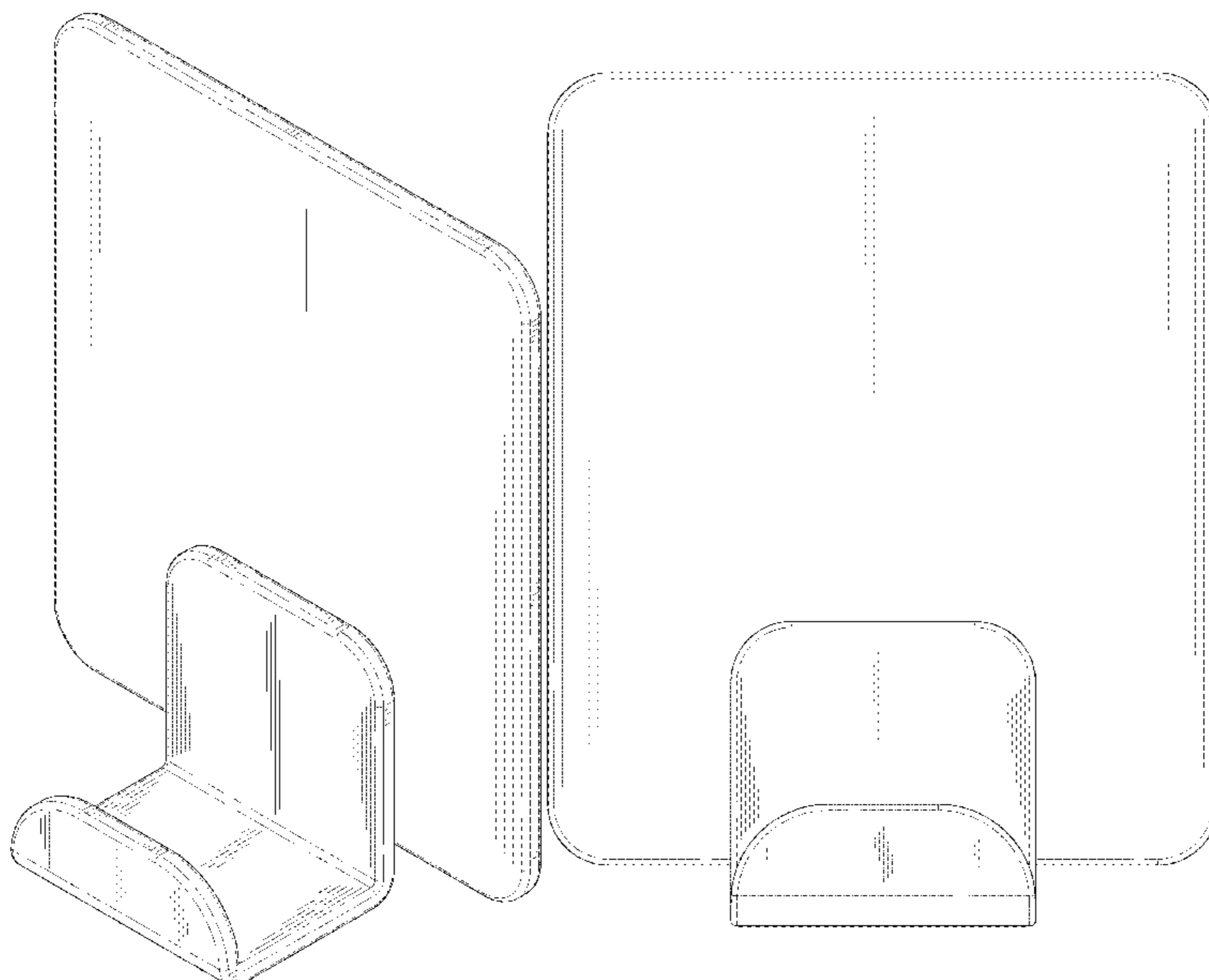

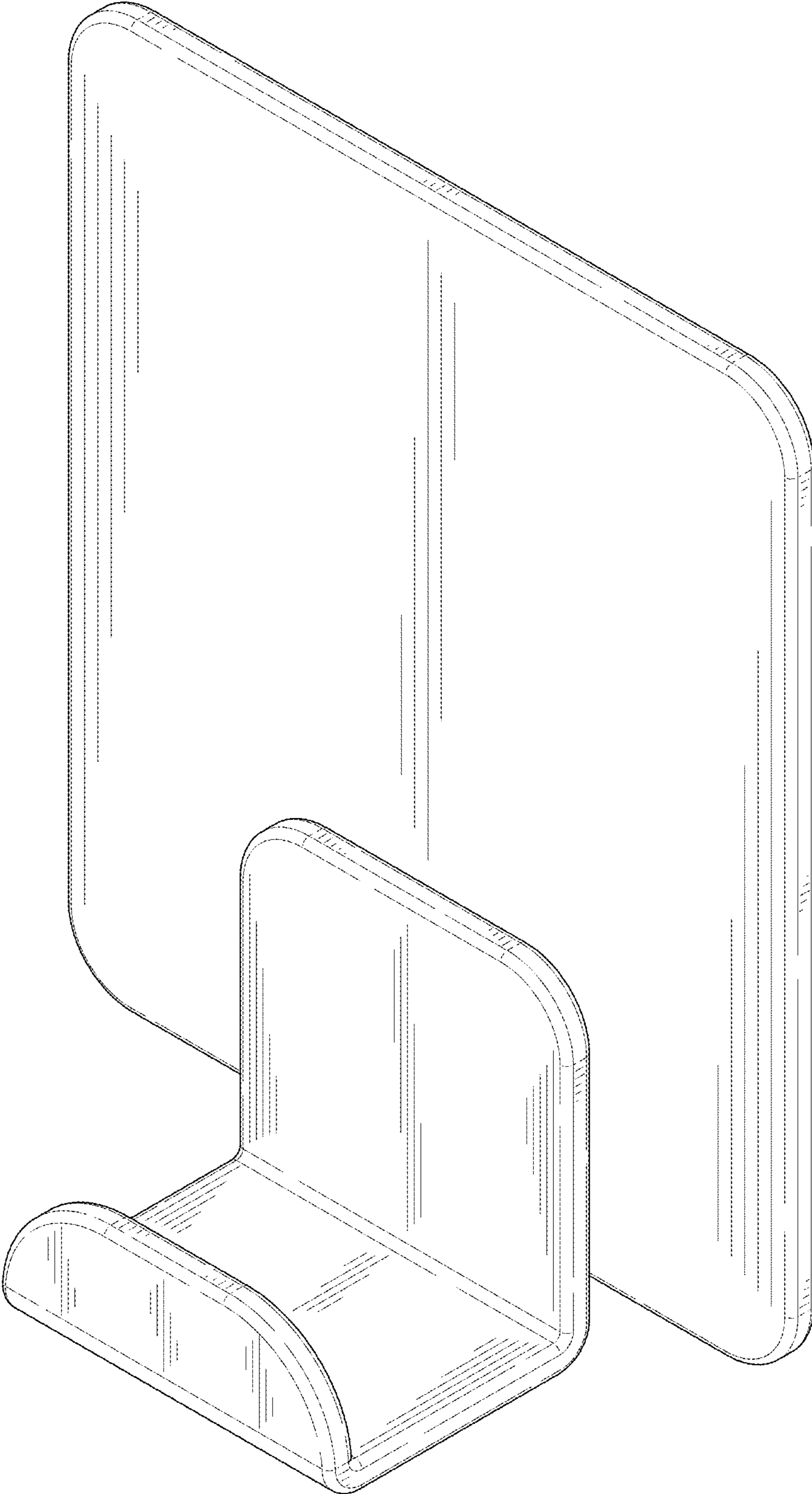

FIG. 1

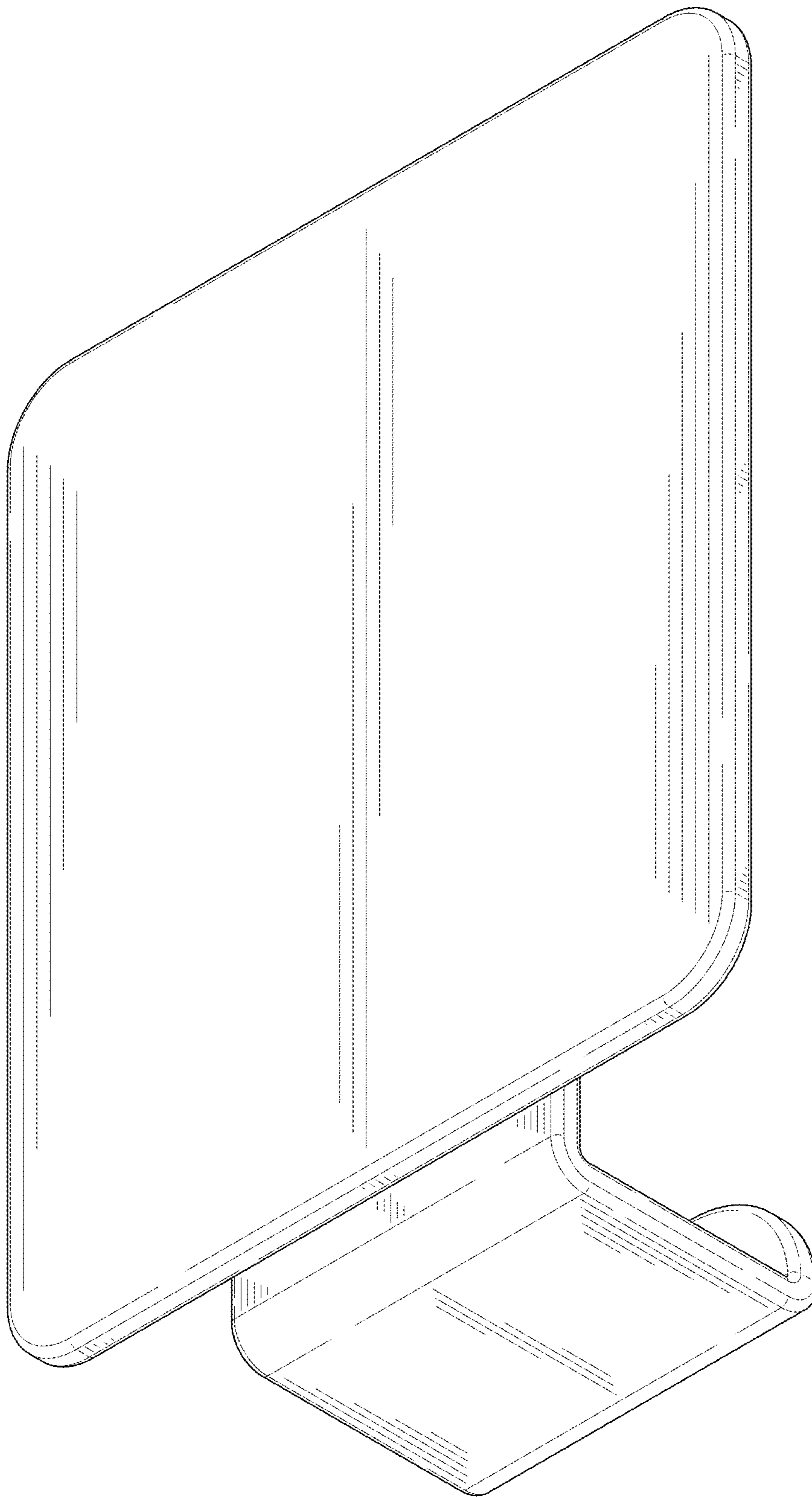

FIG. 2

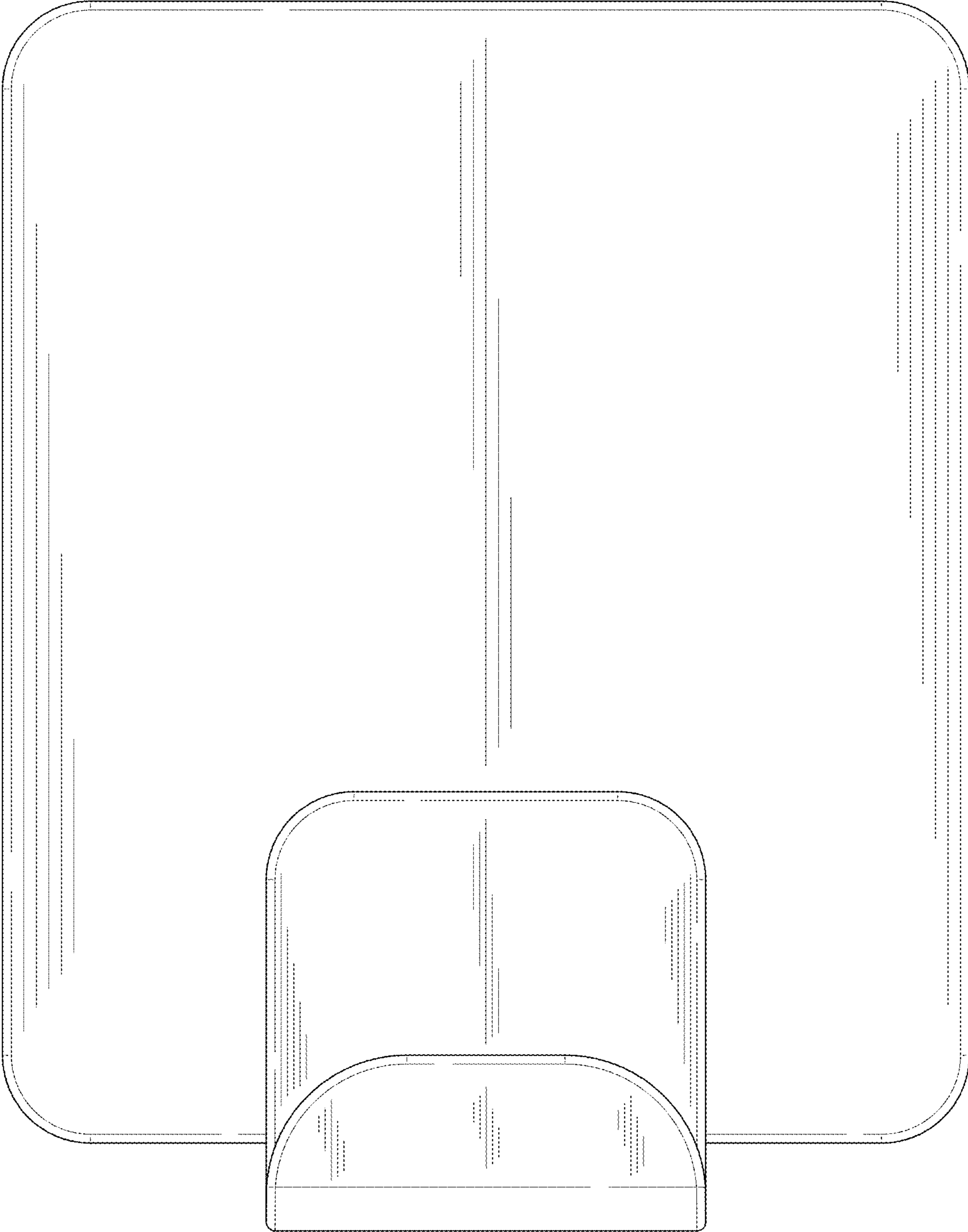

FIG. 3

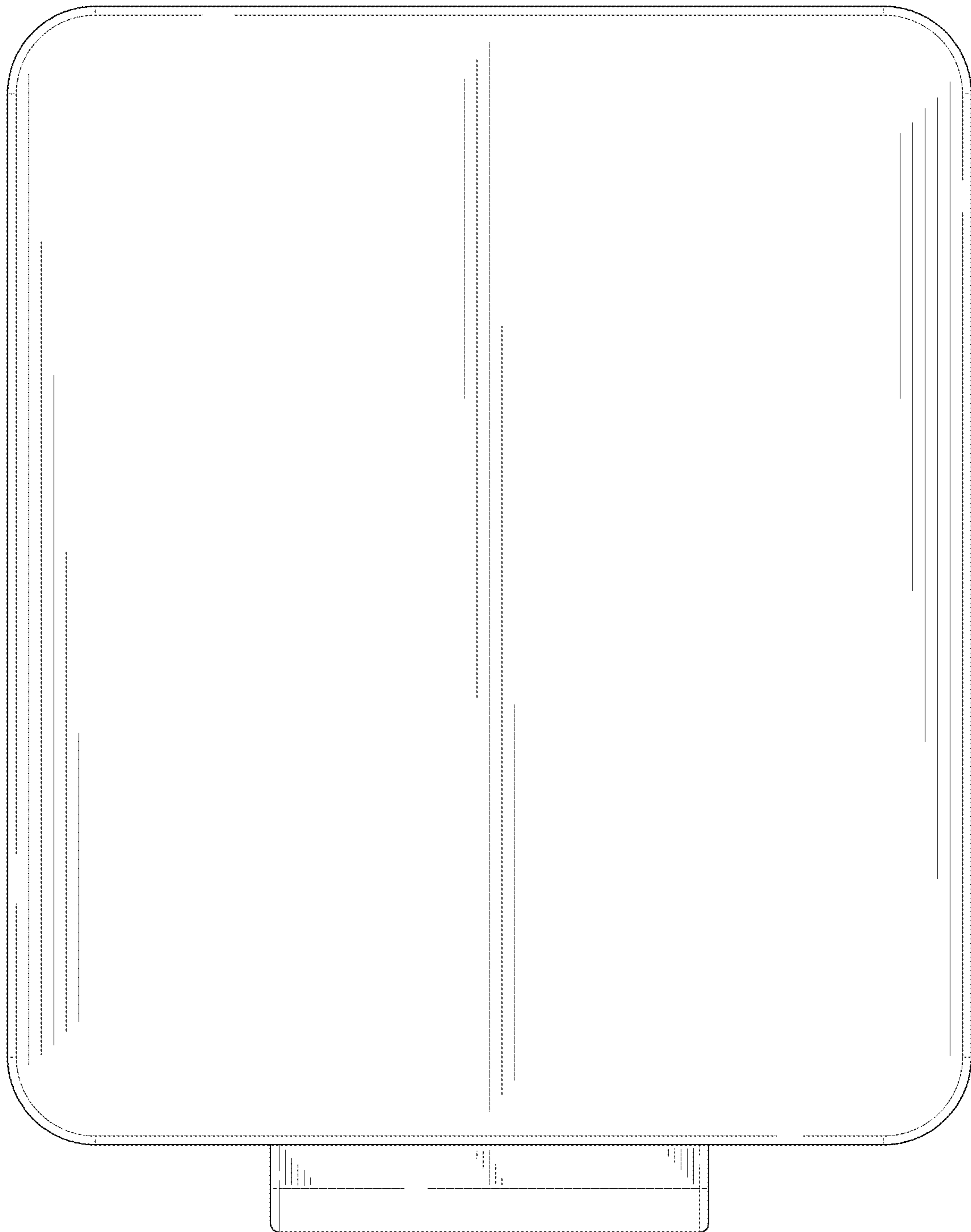

FIG. 4

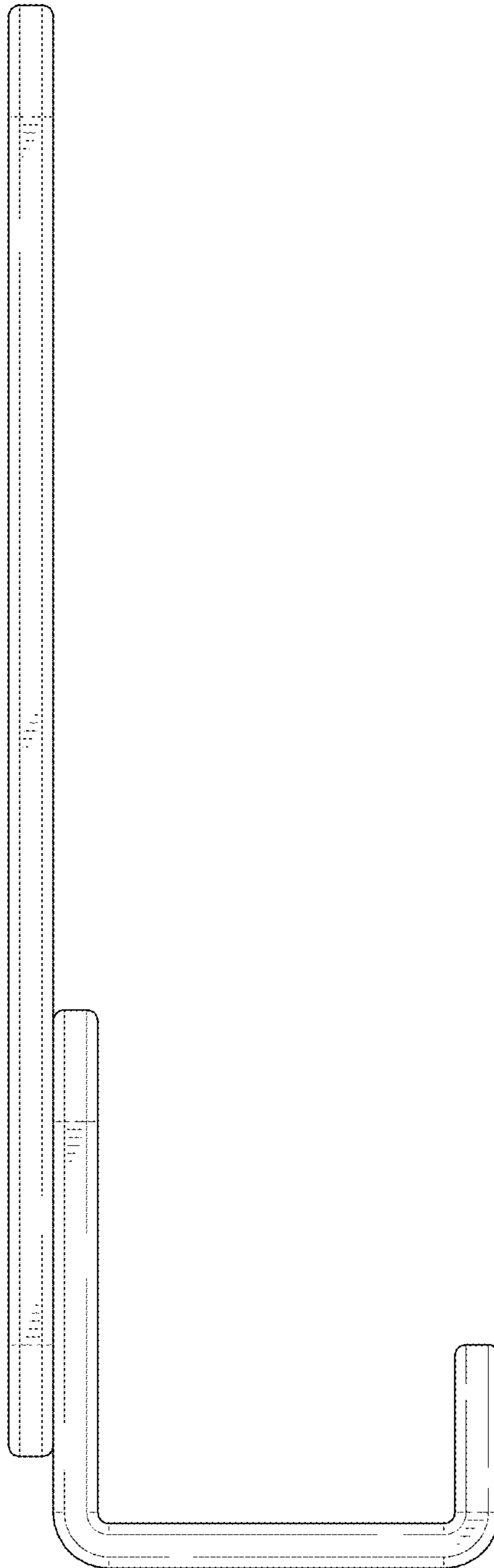

FIG. 5

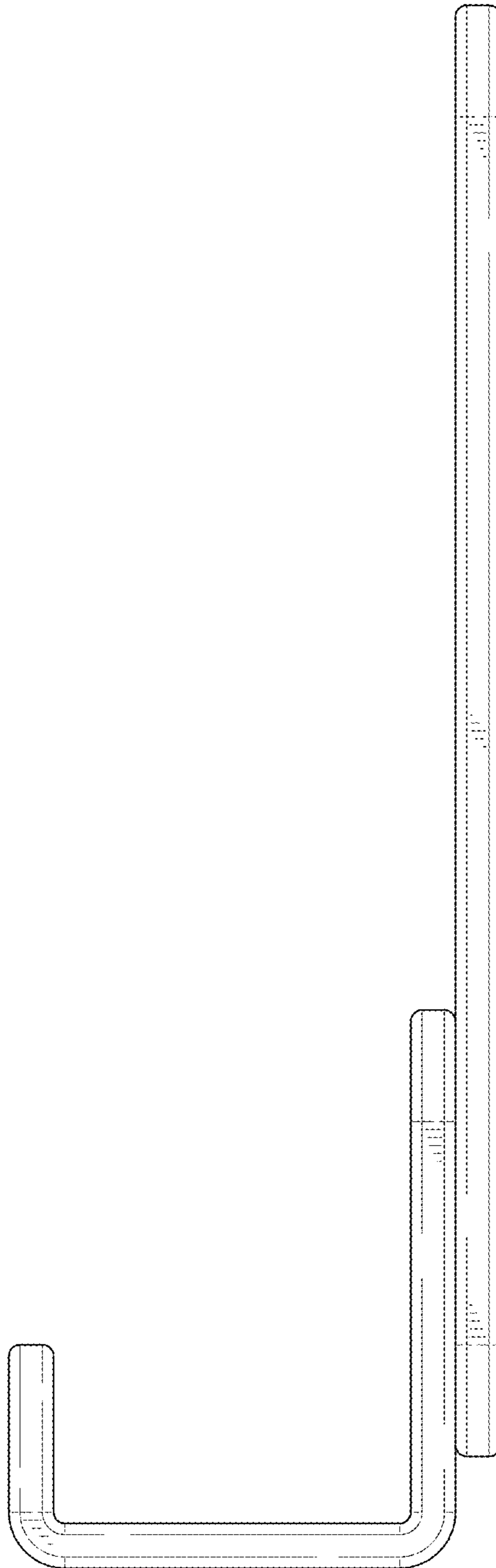

FIG. 6

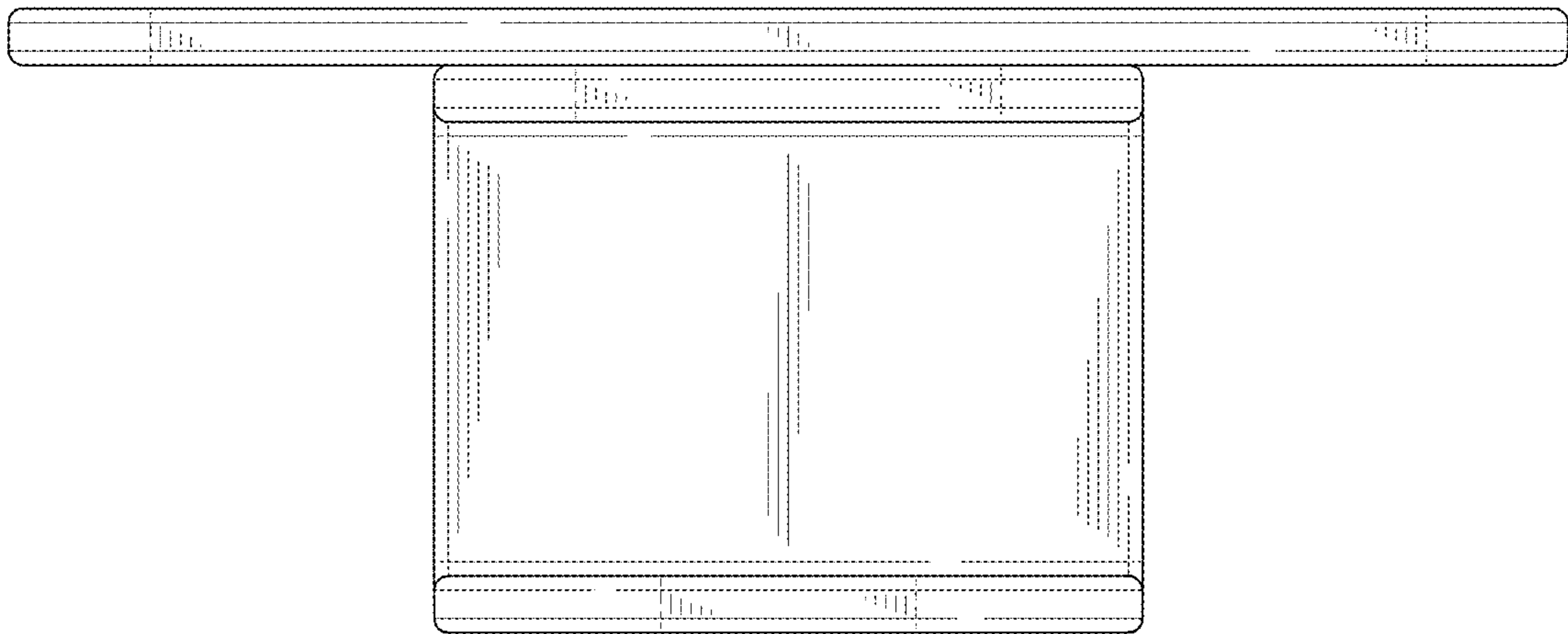

FIG. 7



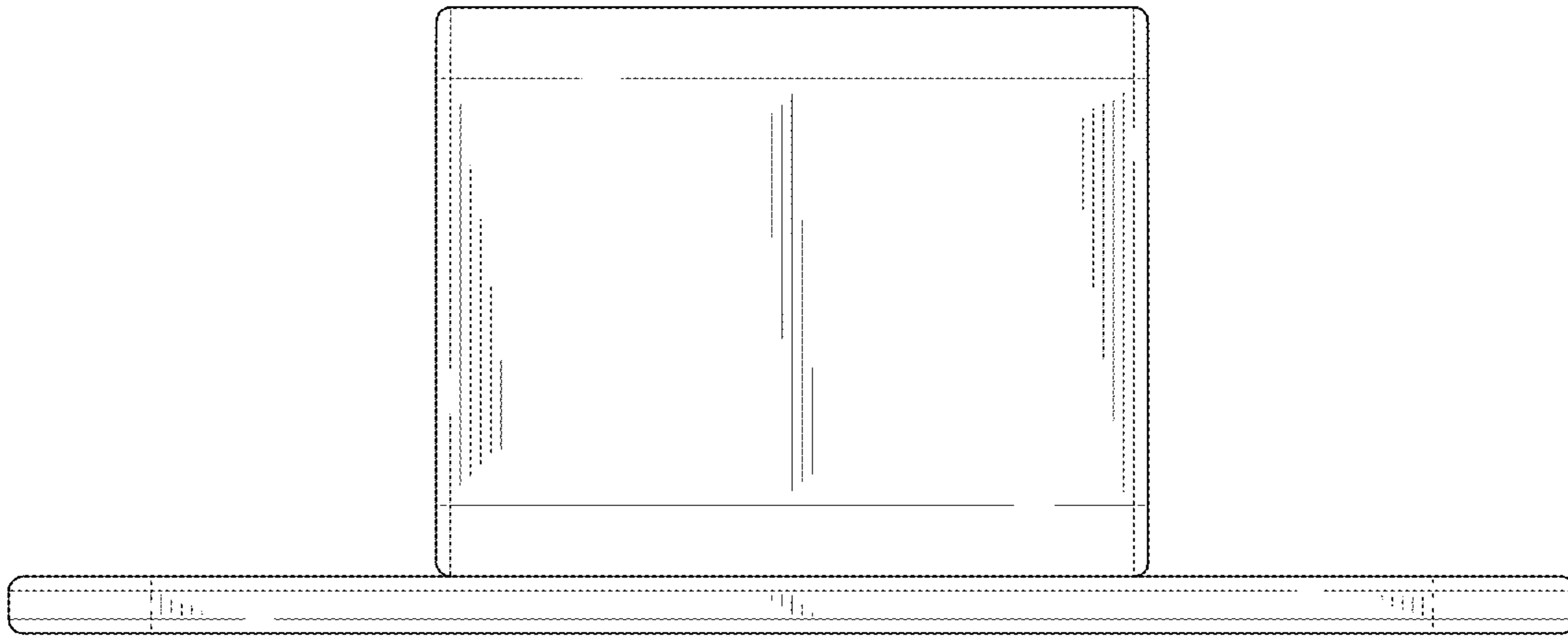

FIG. 8