



US00D970851S

(12) **United States Design Patent** (10) **Patent No.:** **US D970,851 S**
Mozafari (45) **Date of Patent:** **** Nov. 29, 2022**

(54) **PANTS WITH INTEGRATED REMOVABLE WAISTPACK**

<https://www.dillards.com/p/the-north-face-active-trail-high-rise-waist-pack-tight/512254276> (Year: 2021).*

(Continued)

(71) Applicant: **The North Face Apparel Corp.**,
Wilmington, DE (US)

Primary Examiner — Richard E Chilcot

(72) Inventor: **Niloufar Mozafari**, Los Angeles, CA
(US)

(74) *Attorney, Agent, or Firm* — Smith, Gambrell &
Russell LLP

(73) Assignee: **The North Face Apparel Corp.**,
Wilmington, DE (US)

(57) **CLAIM**

The ornamental design for the assembly of pants with integrated removable waistpack, as shown and described.

(**) Term: **15 Years**

DESCRIPTION

(21) Appl. No.: **29/721,177**

FIG. 1 shows a front, right-side perspective view of the pants with integrated removable waistpack.

(22) Filed: **Jan. 17, 2020**

FIG. 2 shows a front view of the assembly of FIG. 1.

(51) **LOC (13) Cl.** **02-02**

FIG. 3 shows a left-side view of the assembly of FIG. 1.

(52) **U.S. Cl.**

FIG. 4 shows a back view of the assembly of FIG. 1.

USPC **D2/742**

FIG. 5 shows a right-side view of the assembly of FIG. 1.

(58) **Field of Classification Search**

USPC D2/742, 704, 712, 744, 747; D3/226

FIG. 6 shows a top view of the assembly of FIG. 1.

(Continued)

FIG. 7 shows a bottom view of the assembly of FIG. 1.

(56) **References Cited**

FIG. 8 shows a front, right-side perspective view of the pants with integrated removable waistpack with the waistpack removed from the assembly for clarity of disclosure.

U.S. PATENT DOCUMENTS

297,268 A * 4/1884 Kepley A45C 1/04
224/587

FIG. 9 shows a front view of the pants of FIG. 8.

2,004,477 A 6/1935 Mather

(Continued)

FIG. 10 shows a left-side view of the pants of FIG. 8.

FOREIGN PATENT DOCUMENTS

CN 203087561 7/2013

CN 206137263 5/2017

(Continued)

FIG. 11 shows a back view of the pants of FIG. 8.

FIG. 12 shows a right-side view of the pants of FIG. 8.

FIG. 13 shows a top view of the pants of FIG. 8.

FIG. 14 shows a bottom view of the pants of FIG. 8.

FIG. 15 shows a left-side perspective view of the pants with integrated removable waistpack with the waistpack only shown removed from the assembly for clarity of disclosure; and,

OTHER PUBLICATIONS

The North Face Active Trail High Rise Waist Pack Tight. Oldest review: Feb. 2021 (“8 months ago”) [visited: Oct. 4, 2021] URL:

FIG. 16 shows a front view of the waistpack from FIG. 15.

The broken lines form no part of the claimed design and illustrate an environment for the portion illustrated with solid lines. The lower leg, interior and buckle regions of the pants with integrated removable waistpack, shown in broken lines, are not part of the claimed design.

1 Claim, 9 Drawing Sheets

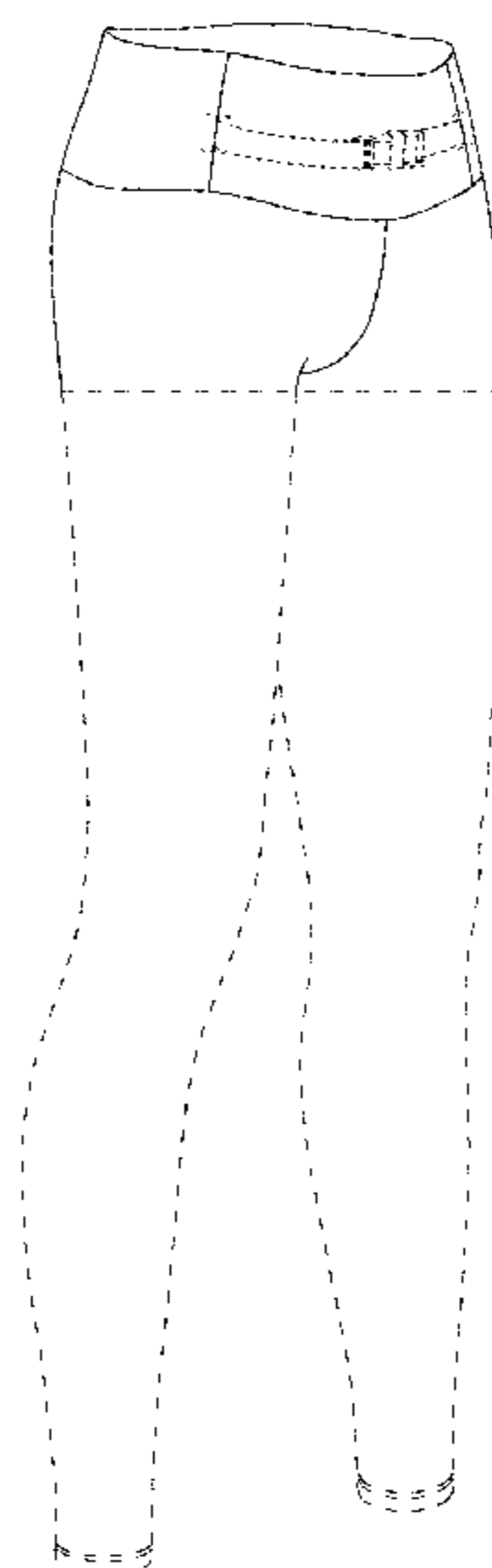

(52) **U.S. Cl.**
CPC A41D 1/06 (2013.01)

(58) **Field of Classification Search**
CPC ... A41D 1/06; A41D 1/08; A41D 1/12; A41D 1/067; A41D 13/0012; A41D 13/0015; A41D 13/129; A41D 27/00; A41D 27/20; A41D 27/205; A41D 2300/322; A41F 9/00; A41F 7/00; A45F 3/14; A45F 2003/144

See application file for complete search history.

(56) **References Cited**

U.S. PATENT DOCUMENTS

D333,570	S	*	3/1993	Murray	D3/226
D334,471	S	*	4/1993	Yerby	D3/226
D371,905	S	*	7/1996	Kopel	D3/226
D374,983	S	*	10/1996	Brucki	D3/226
5,561,865	A	*	10/1996	Fjelstul	A41D 1/06 2/227
D383,889	S	*	9/1997	Gallegos	D2/738
5,669,884	A	*	9/1997	Bennes et al.		
5,836,671	A	*	11/1998	Chien	A45F 3/04 362/84
D408,628	S	*	4/1999	Fusco	D3/226
D426,058	S	*	6/2000	Gaines	D3/215
D458,021	S	*	6/2002	Willows	D3/226
D613,500	S	*	4/2010	Overton	A45F 3/14 D3/226
D613,501	S	*	4/2010	Overton	D3/226
D618,907	S	*	7/2010	Overton	A45F 3/14 D3/226
D641,539	S	*	7/2011	Zarabi	D2/701
D653,028	S	*	1/2012	Willows	D3/226
8,104,654	B2		1/2012	Overton		
D683,521	S	*	6/2013	Garcia	D2/742
9,021,615	B2		5/2015	Cockram		
D731,753	S	*	6/2015	Mahtani	D2/742
D737,049	S	*	8/2015	Seip	D3/226
9,295,289	B2		3/2016	James		
D793,665	S	*	8/2017	Perez	D2/742
D802,915	S	*	11/2017	Willows	D3/226
D812,348	S	*	3/2018	McManus	D2/742
D816,303	S	*	5/2018	Diakonov	D2/857
9,961,947	B2		5/2018	Cockram		
D827,252	S	*	9/2018	Salamat	D2/731
D831,341	S	*	10/2018	Pomerantz	D3/226
D835,402	S	*	12/2018	Pomerantz	D3/226
D839,591	S	*	2/2019	Yamanaka	D3/226

10,194,704	B2	*	2/2019	Nygaard	A41D 1/06
D842,585	S	*	3/2019	Do	D2/731
D857,339	S	*	8/2019	Holmes	D2/742
10,542,816	B1	*	1/2020	Newton	A45F 3/14
D882,248	S	*	4/2020	Dumas	D3/226
D883,661	S	*	5/2020	Olsen	D3/226
D886,414	S	*	6/2020	Landry	D2/731
D893,134	S	*	8/2020	Long	D2/731
D907,332	S	*	1/2021	Liu	D2/742
D909,010	S	*	2/2021	Long	D2/731
10,973,270	B2	*	4/2021	Marshall	A45F 3/005
D928,506	S	*	8/2021	Sandoval	D3/226
2005/0261113	A1		11/2005	Wilkinson		
2008/0190980	A1		8/2008	Overton		
2009/0205096	A1	*	8/2009	Seemann	A41D 15/04 2/4
2019/0335833	A1	*	11/2019	Kelley	A41F 9/007
2019/0350274	A1	*	11/2019	Winget	A41B 11/14
2020/0187573	A1	*	6/2020	Junod	A41D 13/0058
2020/0245704	A1	*	8/2020	Hogberg	A41F 9/00
2020/0352267	A1	*	11/2020	Lazic	A41F 9/00
2021/0022423	A1	*	1/2021	Cox	A41F 9/02
2021/0219701	A1	*	7/2021	Mozafari	A41F 9/02
2021/0235780	A1	*	8/2021	Prinzing	A41D 27/205

FOREIGN PATENT DOCUMENTS

CN	305133705	*	12/2018
CN	306427565	*	4/2021
EM	003825405-0006	*	3/2017
EM	008039564-0001	*	7/2020
JP	2010100978		5/2010
JP	D1678626	*	7/2020
KR	300961048.0000	*	6/2018
KR	301082188.0000	*	11/2020

OTHER PUBLICATIONS

Black Leggings w/ Neon Fanny Pack. Published: Oct. 2, 2018 [visited: Oct. 4, 2021] URL: <https://sportvivos.com/female-activewear/black-leggings-w-neon-fanny-pack/> (Year: 2018).*

Ibeauti Yoga Pants. First available: Aug. 7, 2019 [visited: Oct. 4, 2021] URL: <https://www.amazon.com/Ibeauti-Running-Pockets-Leggings-Workout/dp/B07W6P4J9G> (Year: 2019).*

Level Terrain Flipbelt Crops, first available: Apr. 6, 2021 [visited: Oct. 4, 2021] URL: https://www.amazon.com/Level-Terrain-Crops-Waist-X-Large/dp/B076FFX2BB?ref_=ast_sto_dp&th=1&psc=1 (Year: 2021).*

International Search Report and Written Opinion for PCT Application No. PCT/US2020/038844, dated Oct. 5, 2020, 9 pages.

* cited by examiner

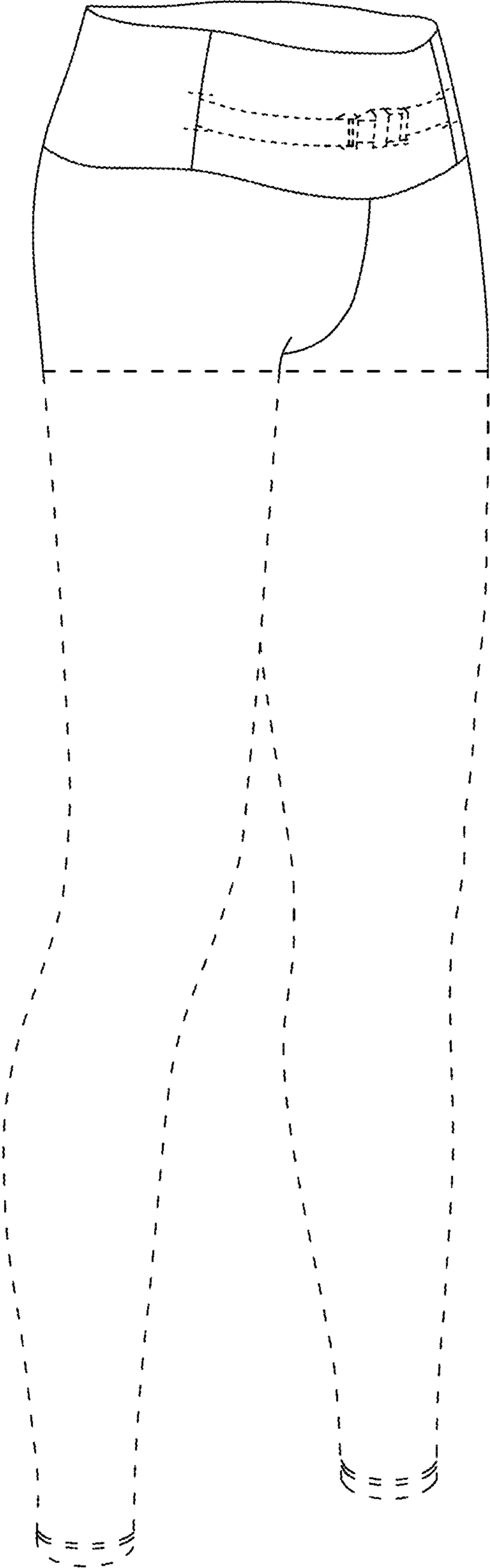

FIG. 1

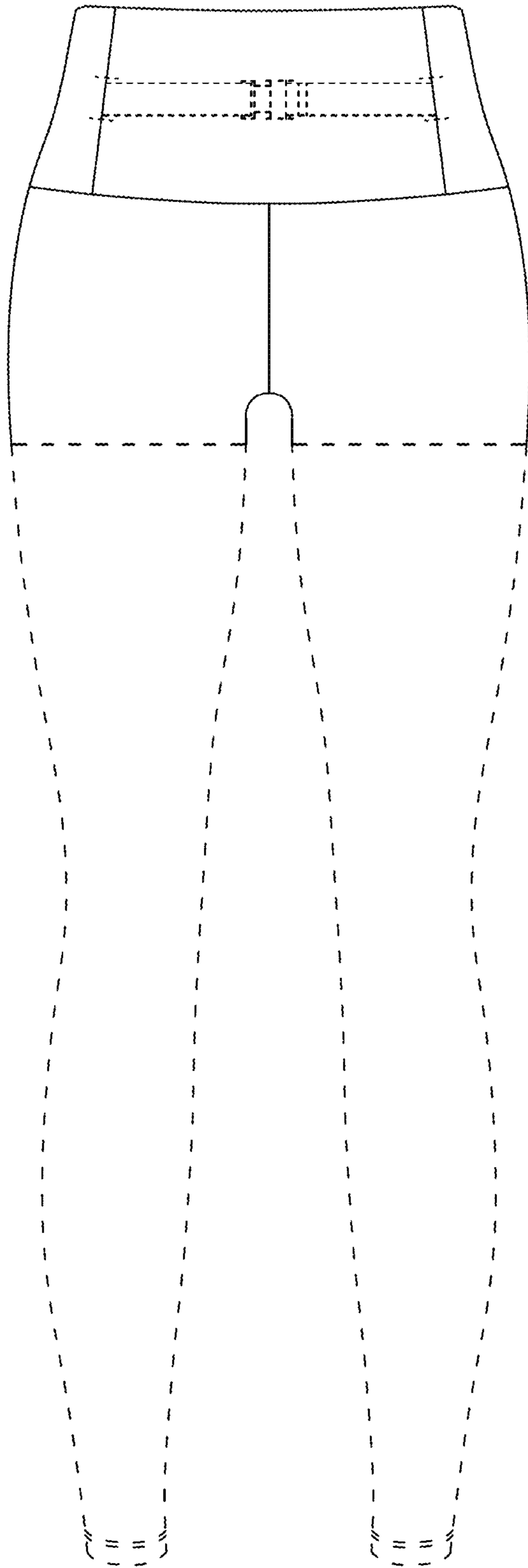

FIG. 2

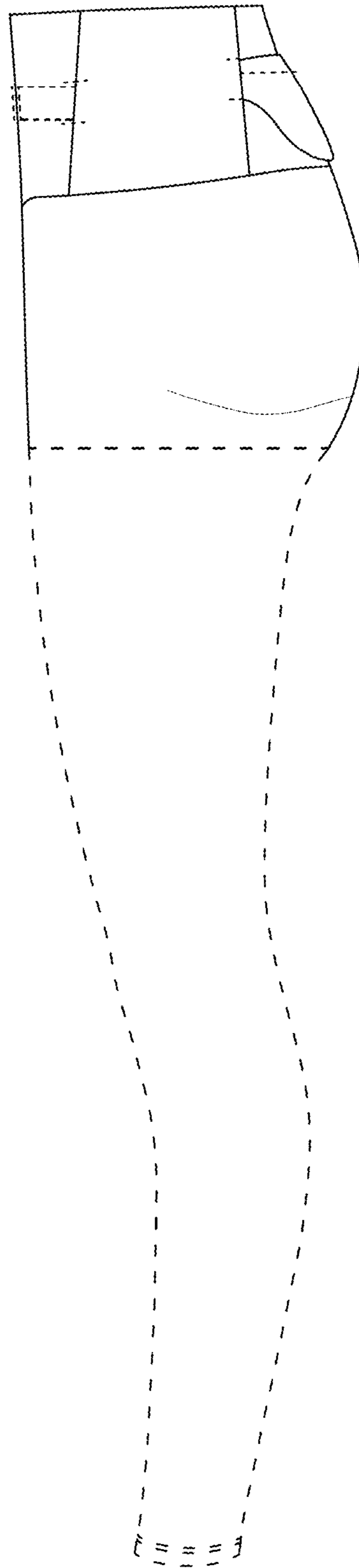

FIG. 3

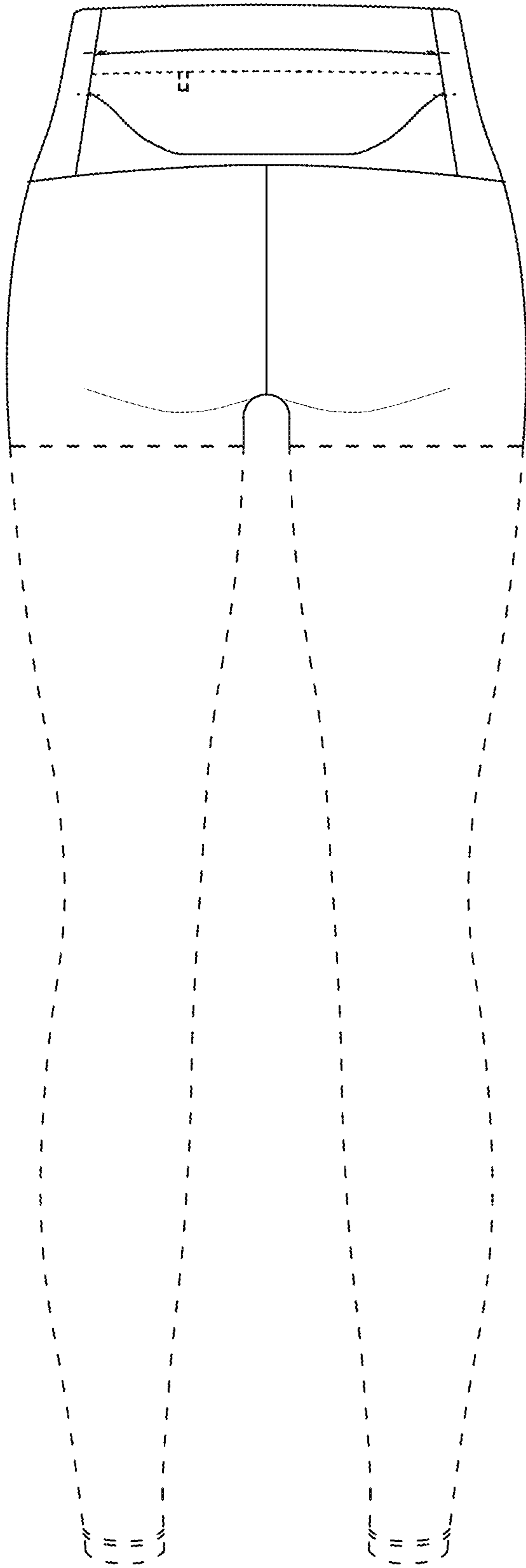

FIG. 4

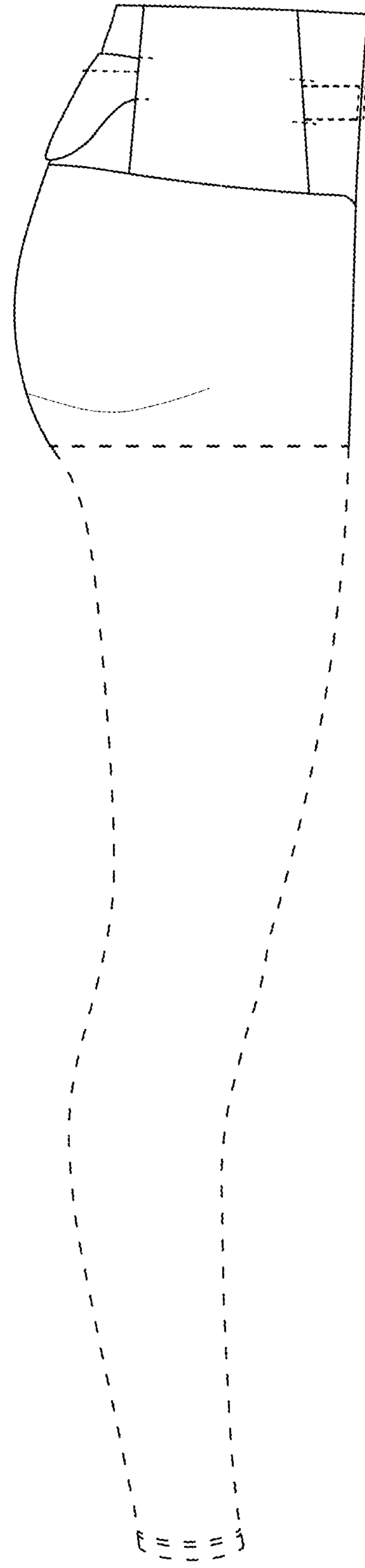

FIG. 5

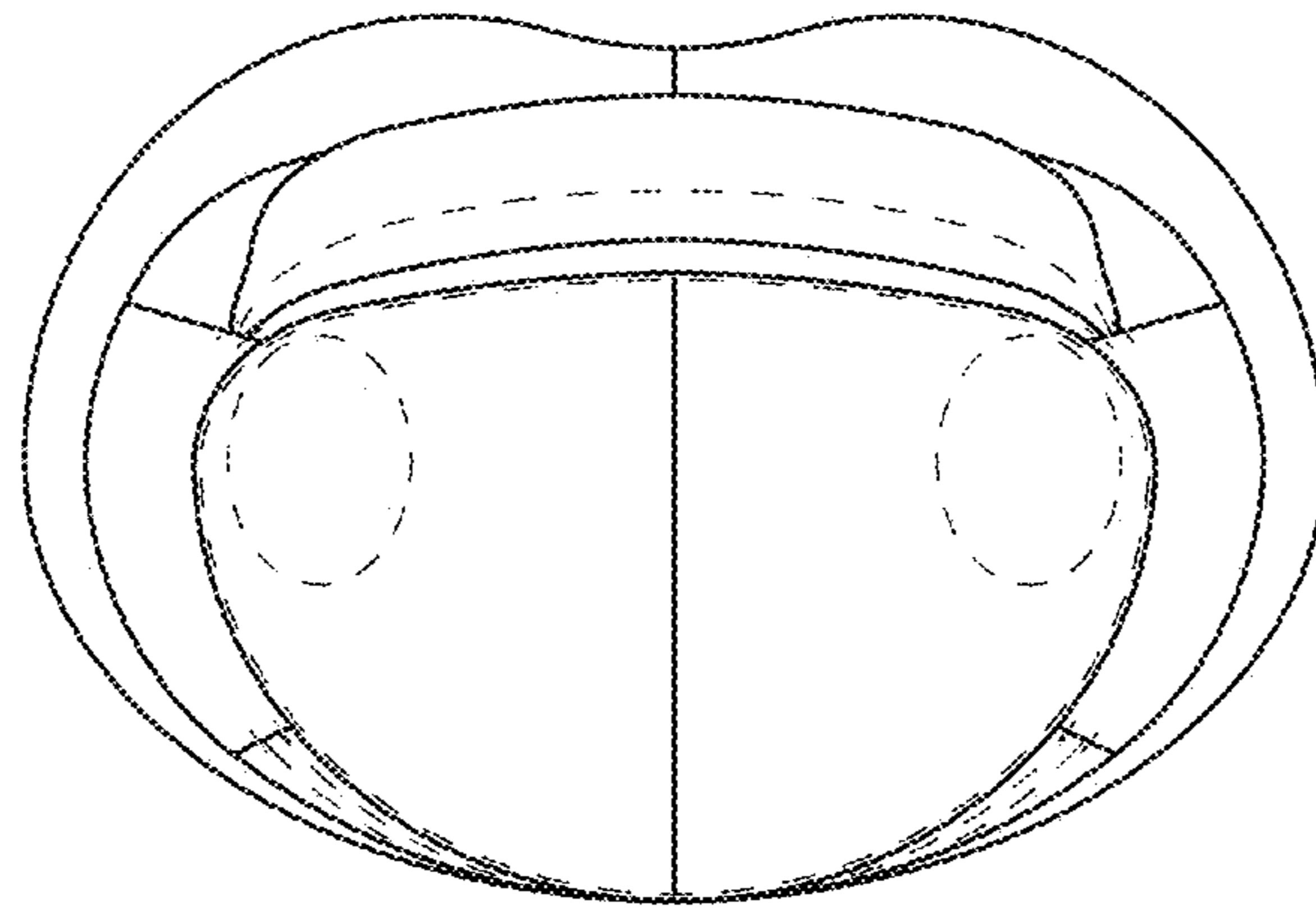

FIG. 6

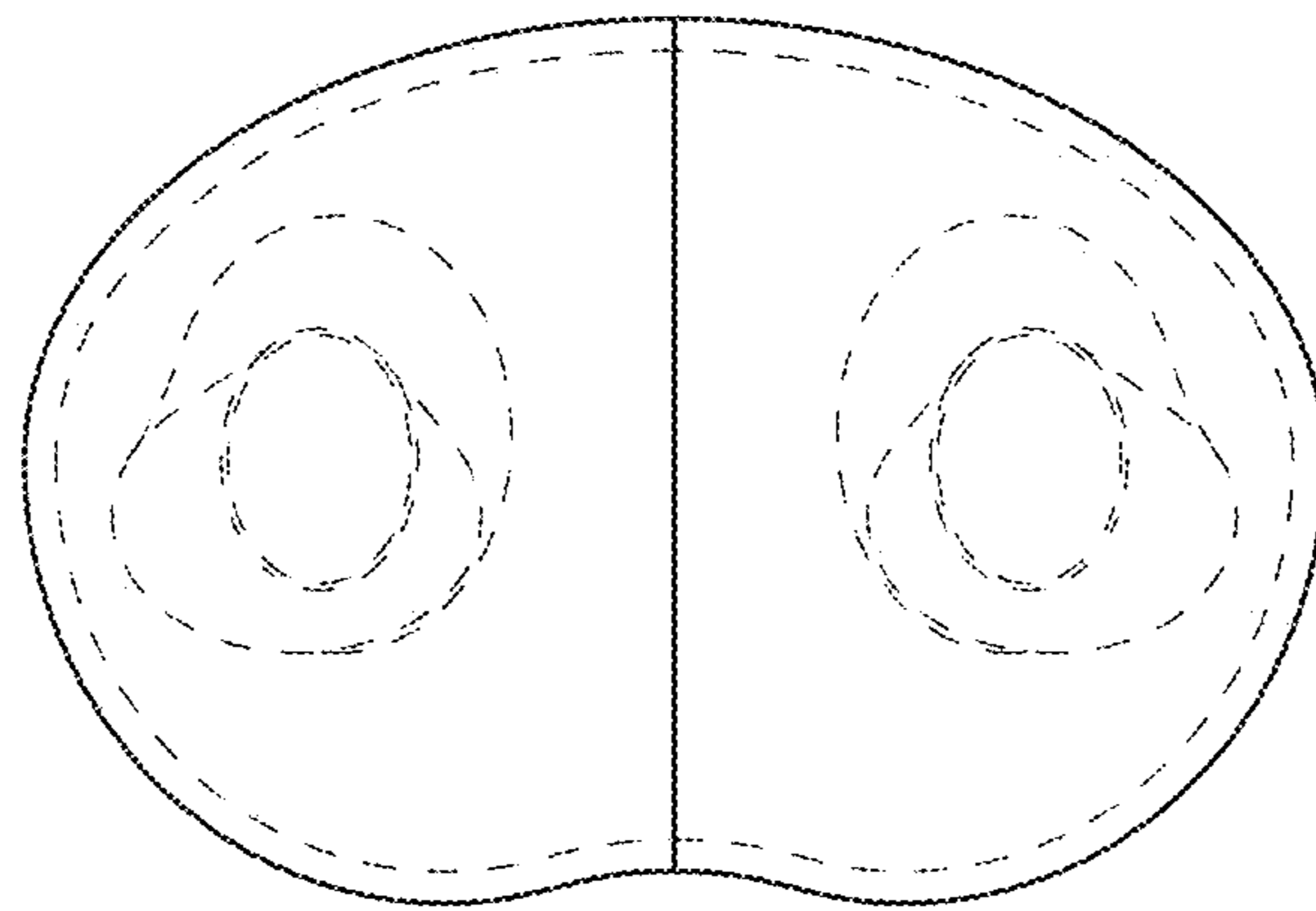

FIG. 7

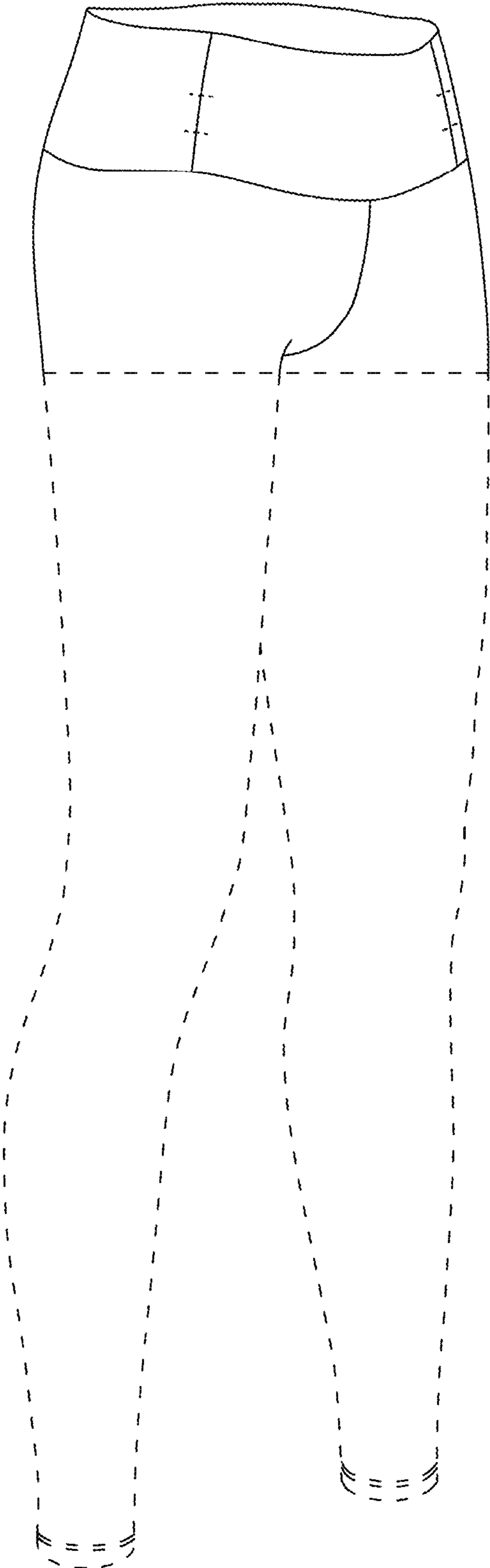

FIG. 8

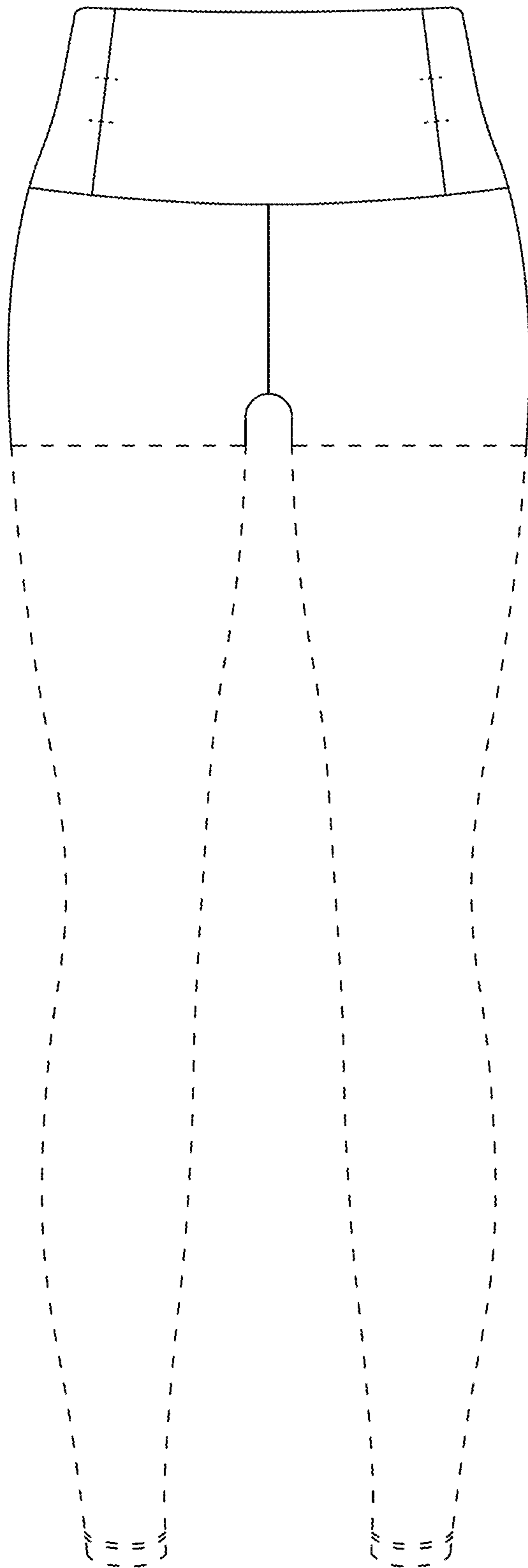

FIG. 9

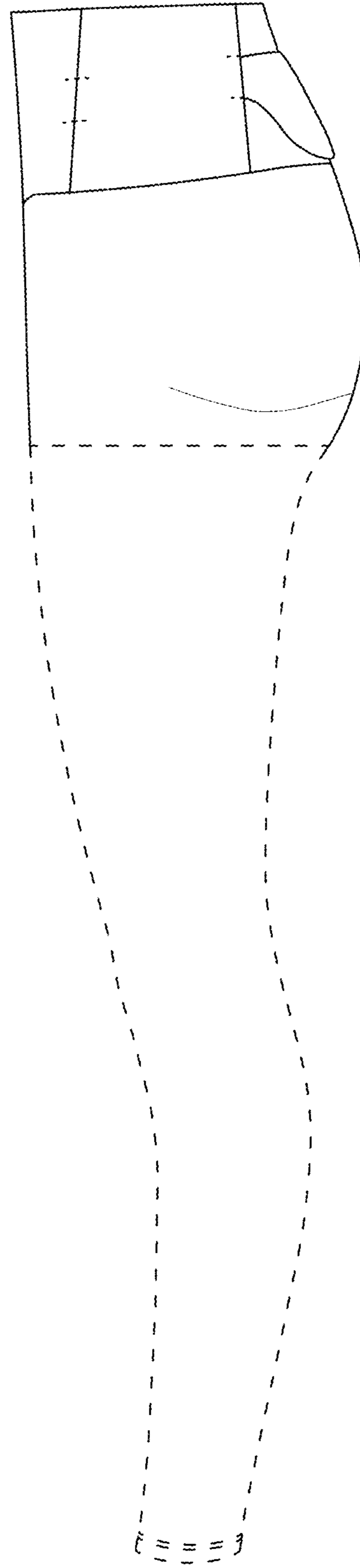

FIG. 10

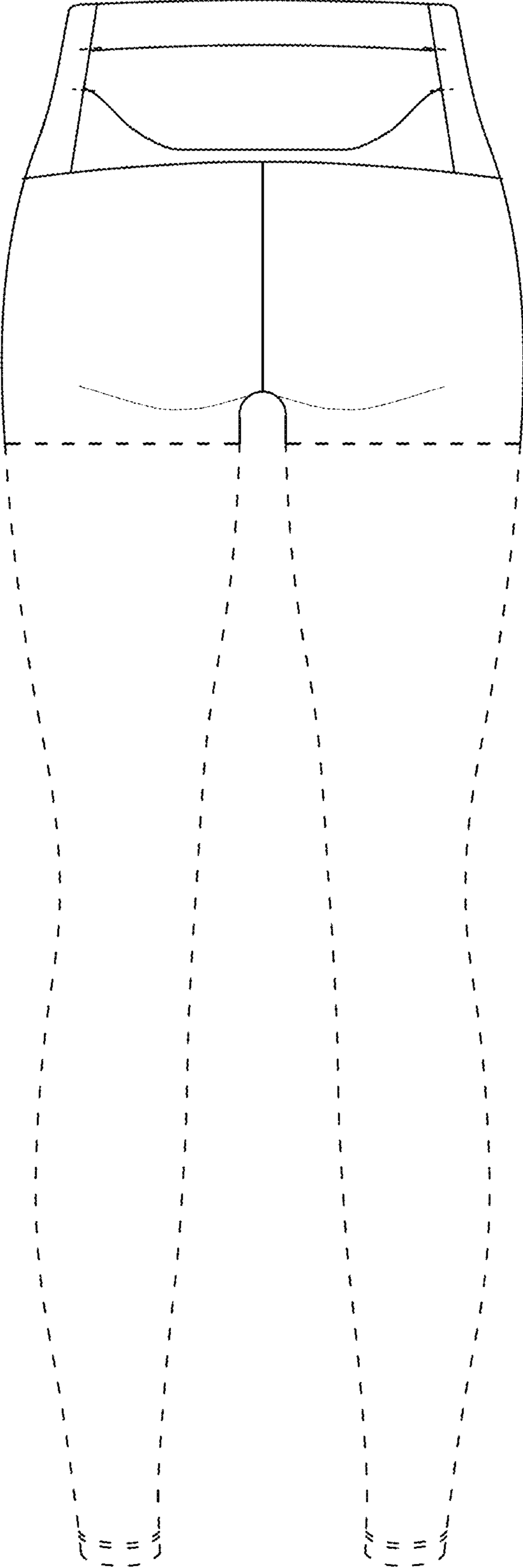

FIG. 11

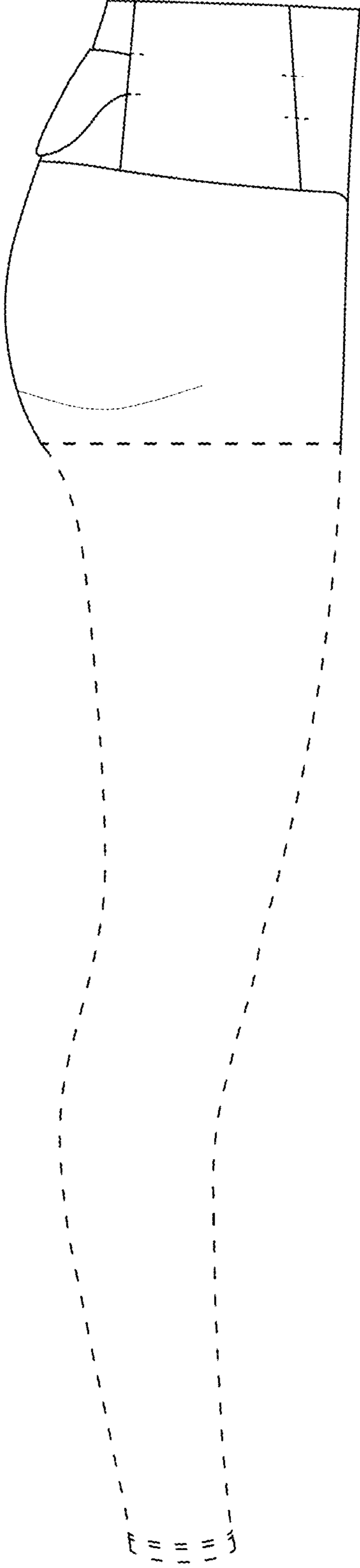

FIG. 12

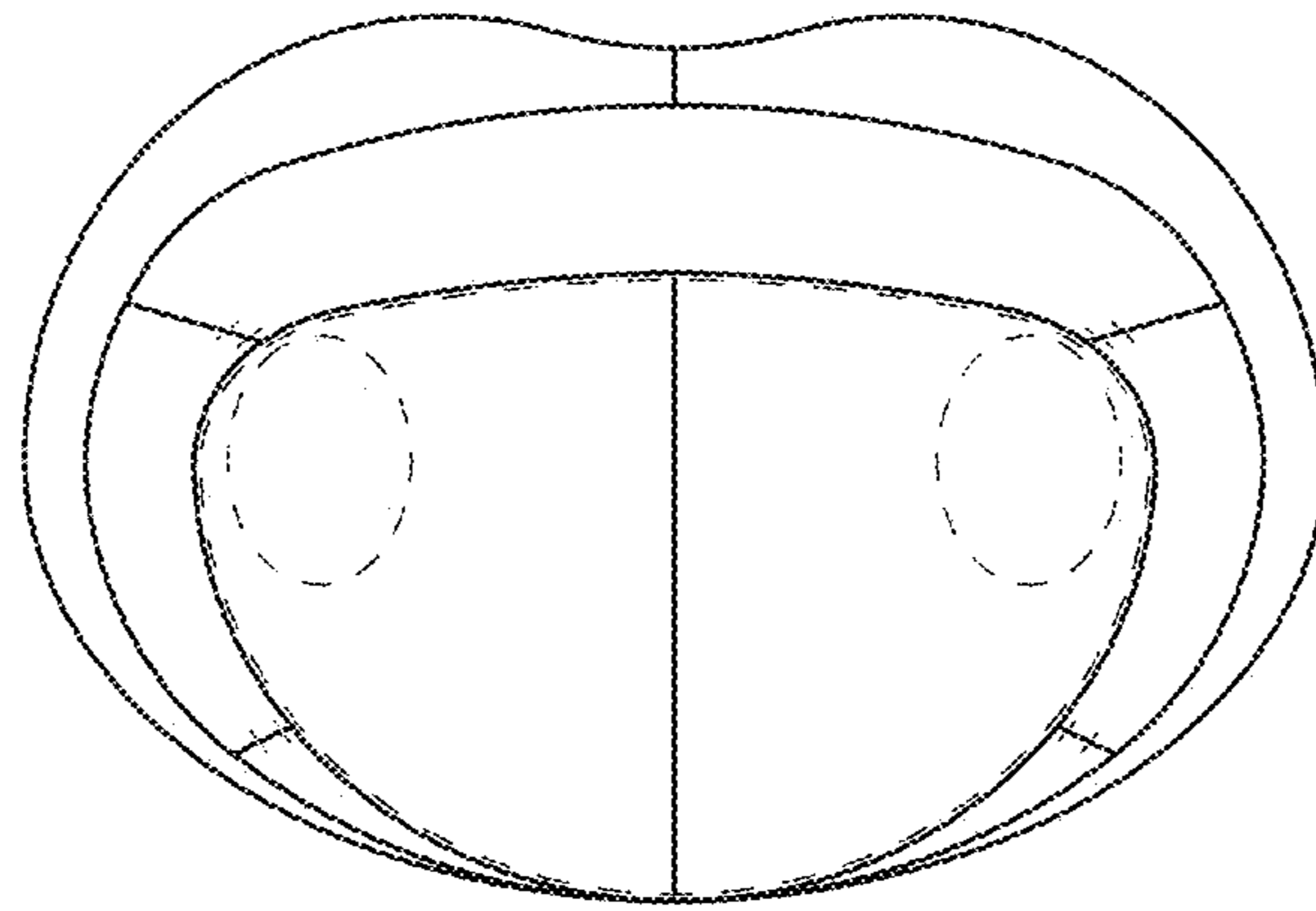

FIG. 13

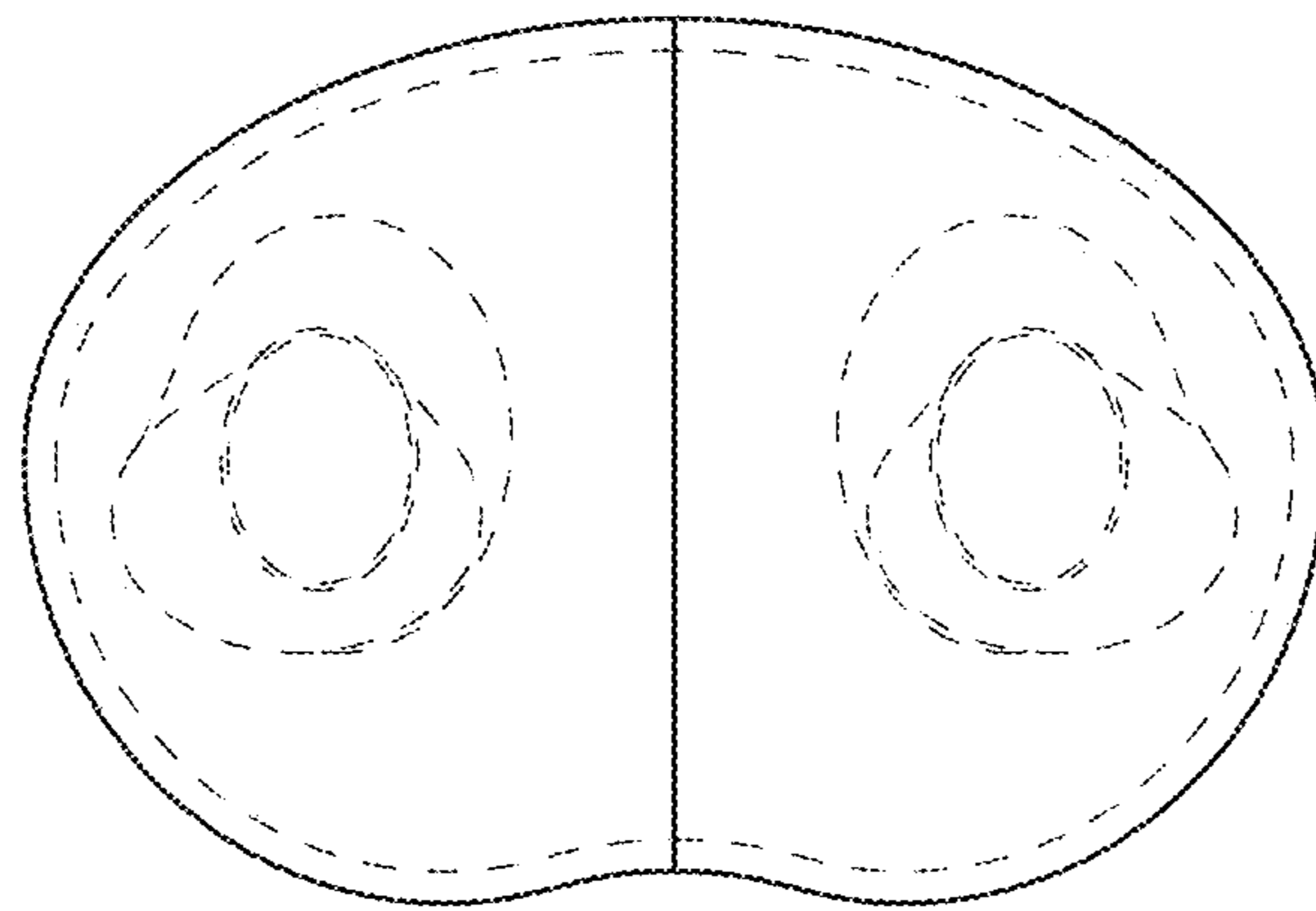

FIG. 14

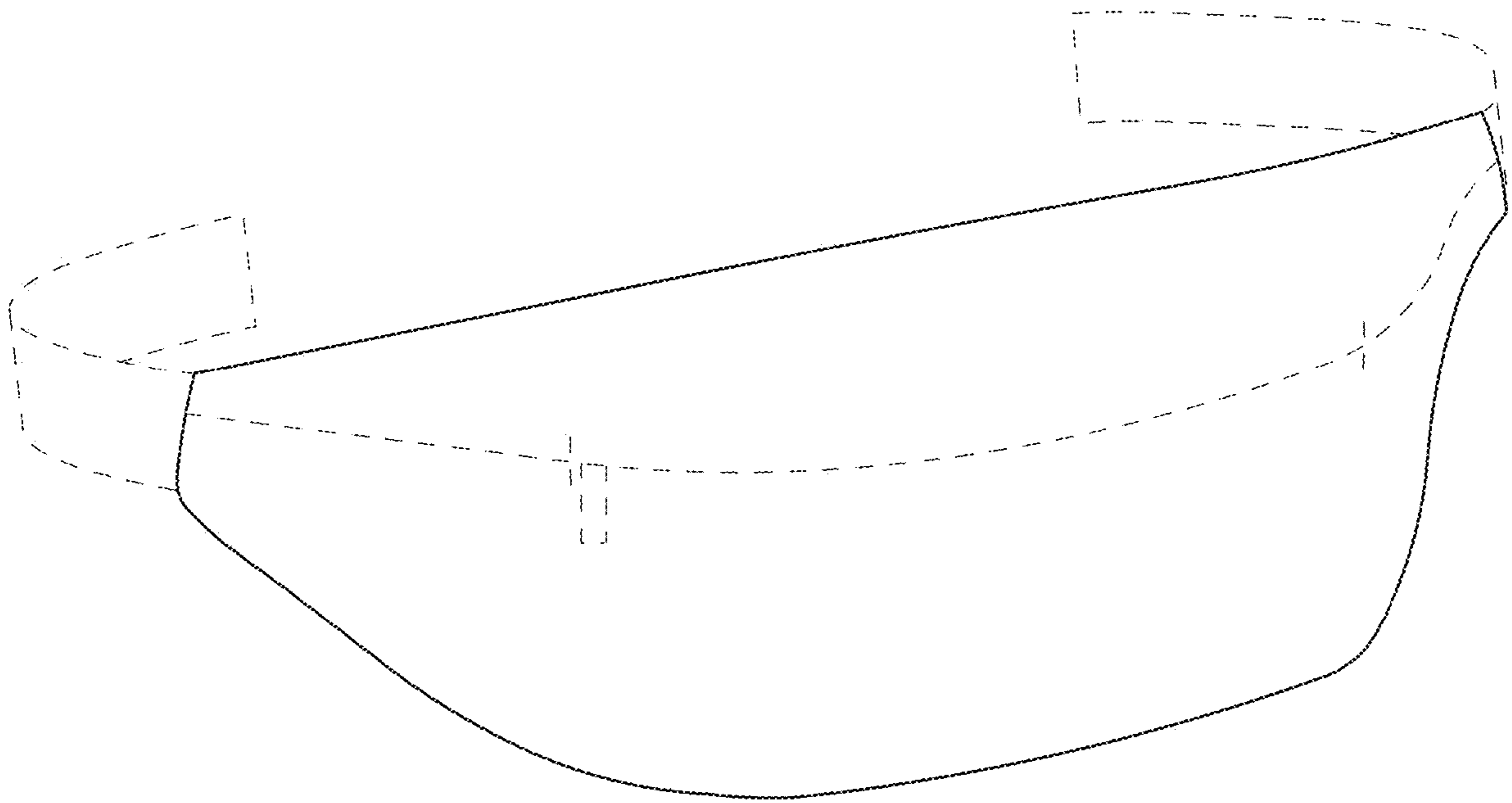

FIG. 15

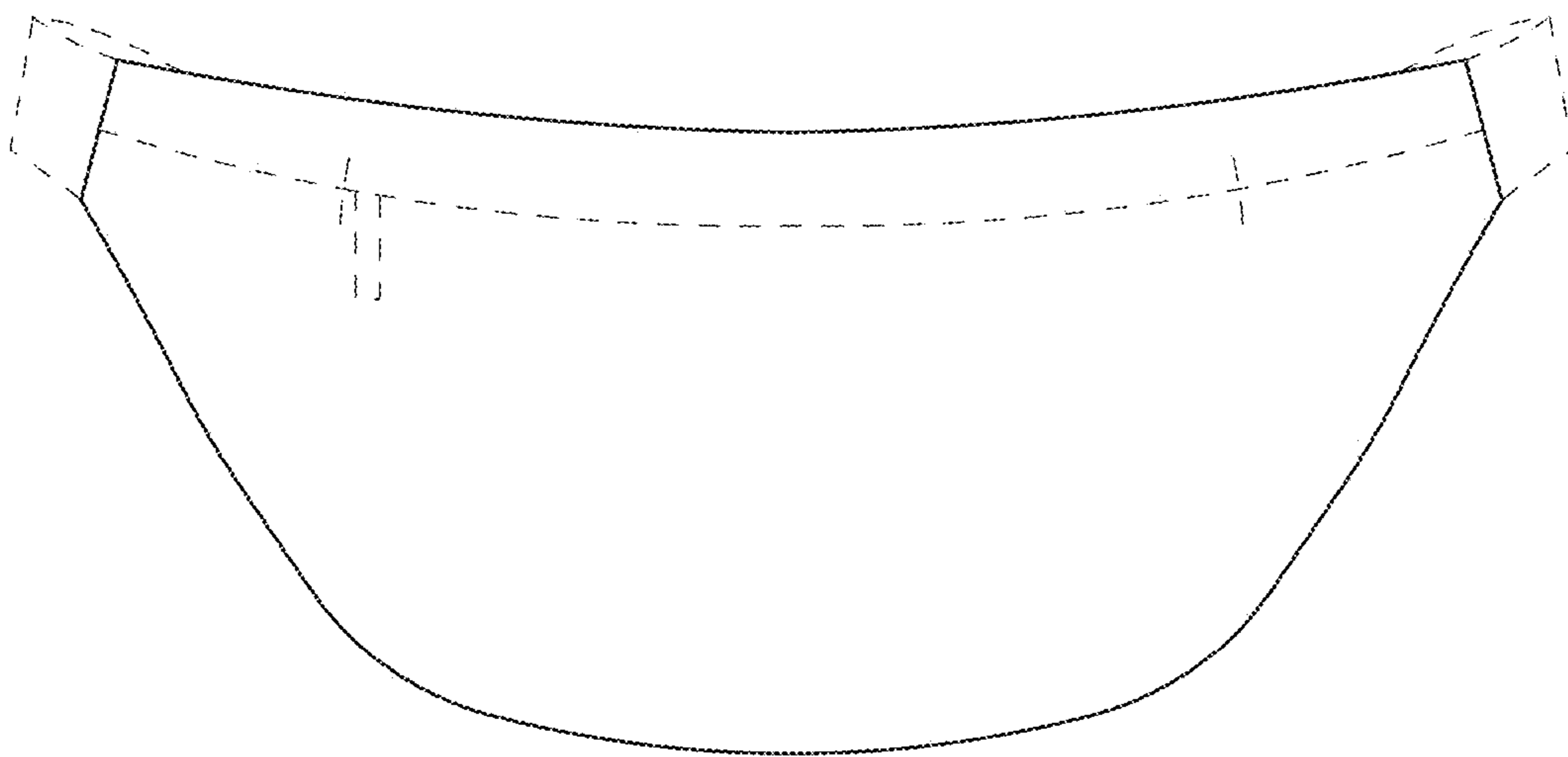

FIG. 16