



US00D970760S

(12) **United States Design Patent** (10) **Patent No.:** **US D970,760 S**  
**Li** (45) **Date of Patent:** **\*\* Nov. 22, 2022**

(54) **LAMP**

(71) Applicant: **JIANGXI AOSAI OPTOELECTRONICS CO., LTD.,**  
Ganzhou (CN)

(72) Inventor: **Chazhao Li,** Ganzhou (CN)

(73) Assignee: **JIANGXI AOSAI OPTOELECTRONICS CO., LTD.,**  
Ganzhou (CN)

(\*\*) Term: **15 Years**

(21) Appl. No.: **29/845,427**

(22) Filed: **Jul. 7, 2022**

**Related U.S. Application Data**

(63) Continuation-in-part of application No. 29/845,243,  
filed on Jul. 6, 2022.

(51) **LOC (13) Cl.** ..... **26-04**

(52) **U.S. Cl.**  
USPC ..... **D26/25**

(58) **Field of Classification Search**  
USPC ..... D26/1, 24, 25, 27, 77, 113, 118  
(Continued)

(56) **References Cited**

**U.S. PATENT DOCUMENTS**

D370,984 S \* 6/1996 Stencil ..... D26/25  
5,601,361 A \* 2/1997 Lawrence ..... F21S 4/10  
362/238

(Continued)

**FOREIGN PATENT DOCUMENTS**

GB 6128163 \* 4/2021  
GB 6128164 \* 4/2021

(Continued)

**OTHER PUBLICATIONS**

HeKation Net Mesh String Lights, available in <https://www.amazon.com/>, posted: Aug. 25, 2021 [online], [site visited Sep. 20, 2022], Internet URL: [https://www.amazon.com/Waterproof-Lighting-Outdoor-Christmas-Decorative/dp/B09GVKZPHQ/ref=asc\\_df\\_B09GVKZPHQ/?tag=hyprod-20&linkCod%E2%80%A6](https://www.amazon.com/Waterproof-Lighting-Outdoor-Christmas-Decorative/dp/B09GVKZPHQ/ref=asc_df_B09GVKZPHQ/?tag=hyprod-20&linkCod%E2%80%A6) (Year: 2021).\*

(Continued)

*Primary Examiner* — Samantha Wood

*Assistant Examiner* — Alex T. Milbrath

(74) *Attorney, Agent, or Firm* — Daniel M. Cohn;  
Howard M. Cohn

(57) **CLAIM**

The ornamental design for a lamp, as shown and described.

**DESCRIPTION**

FIG. 1 is a perspective view of a lamp showing my new design;

FIG. 2 is another perspective view thereof;

FIG. 3 is a front elevational view thereof;

FIG. 4 is a rear elevational view thereof;

FIG. 5 is a left side elevational view thereof;

FIG. 6 is a right side elevational view thereof;

FIG. 7 is a top plan view thereof;

FIG. 8 is a bottom plan view thereof;

FIG. 9 is a perspective view of the lamp where the lamp is in a configuration of use; and,

FIG. 10 is an enlarged view of portion 10 shown in FIG. 1.

The lamp are shown with symbolic breaks in its length and the appearance of any portion of the lamp between the break lines form no part of the claimed design. The dash-dash in the drawings depict portions of the lamp that form no part of the claimed design. The dot-dash broken lines represent the boundary of the enlarged portion and form no part of the claimed design.

**1 Claim, 10 Drawing Sheets**

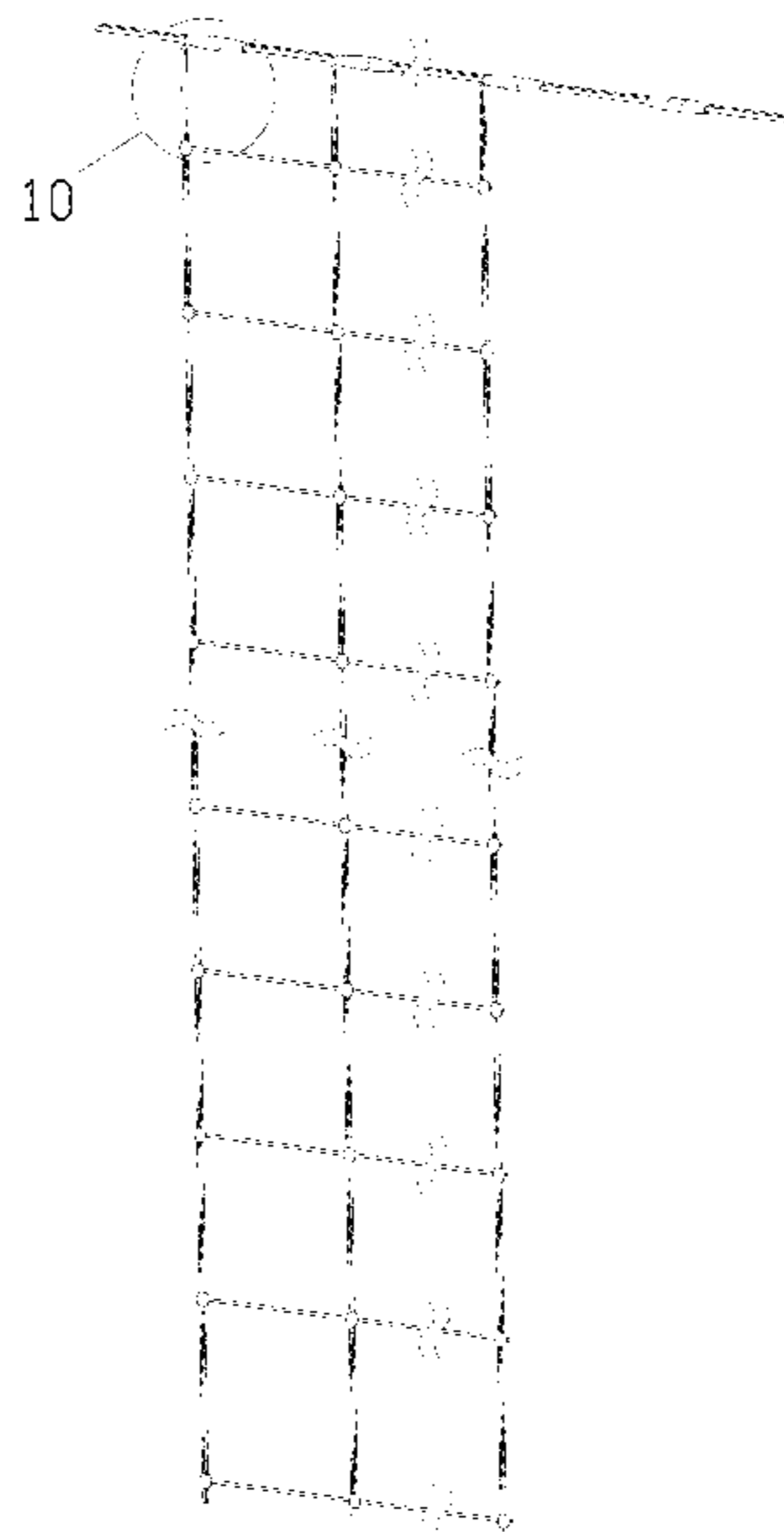

(58) **Field of Classification Search**

CPC ..... F21S 4/00; F21S 4/10; F21S 4/15; F21S 4/20; F21S 13/14; F21V 21/00; F21V 21/008; F21V 23/00; F21W 2121/00; F21W 2121/04

See application file for complete search history.

2014/0313726 A1\* 10/2014 Chiang ..... F21V 23/007  
362/249.16  
2015/0078000 A1\* 3/2015 Chen ..... F21S 4/15  
362/249.16  
2017/0114967 A1\* 4/2017 Chen ..... F21V 23/06

FOREIGN PATENT DOCUMENTS

GB 6128184 \* 4/2021  
GB 6128191 \* 4/2021  
GB 6137032 \* 5/2021

(56)

**References Cited**

U.S. PATENT DOCUMENTS

5,951,146 A \* 9/1999 Lin ..... F21S 4/10  
362/249.15  
6,135,616 A \* 10/2000 Rahman ..... H05B 47/155  
362/249.15  
6,267,486 B1 \* 7/2001 Tai ..... F21V 21/088  
362/249.15  
D690,038 S \* 9/2013 Colbert, Jr. .... D26/25  
D875,973 S \* 2/2020 Zhou ..... D26/25  
D910,890 S 2/2021 Yang  
D914,927 S 3/2021 Liu  
D915,643 S \* 4/2021 Liang ..... D26/25  
11,231,151 B1 \* 1/2022 Liu ..... F21S 4/15  
D947,419 S \* 3/2022 He ..... D26/1  
D951,496 S \* 5/2022 Xiao ..... D26/25  
D952,196 S \* 5/2022 Xu ..... D26/25  
D953,585 S \* 5/2022 Lin ..... D26/25  
D961,123 S \* 8/2022 Bai ..... D26/25  
D962,494 \* 8/2022 Zheng ..... D26/1  
2003/0071580 A1 \* 4/2003 Chang ..... F21S 4/15  
315/185 S  
2004/0136191 A1 \* 7/2004 Bluford ..... F21S 4/10  
362/249.19

OTHER PUBLICATIONS

Gresonic Net Mesh Lights, available in <https://www.amazon.com/>, posted: Aug. 21, 2020 [online], [site visited Sep. 20, 2022], Internet URL: [https://www.amazon.com/dp/B08GFQM33R/ref=sspa\\_dk\\_detail\\_3?pd\\_rd\\_i=B08GFQM33R&pd\\_rd\\_w=PRbmT&content-id=amzn1.sym.3481f441-61a%E2%80%A6](https://www.amazon.com/dp/B08GFQM33R/ref=sspa_dk_detail_3?pd_rd_i=B08GFQM33R&pd_rd_w=PRbmT&content-id=amzn1.sym.3481f441-61a%E2%80%A6) (Year: 2020).\*

Qeaeer Electric Fence Netting, available in <https://www.amazon.com/>, posted: May 27, 2022 [online], [site visited Sep. 20, 2022], Internet URL: [https://www.amazon.com/dp/B0B2J1J1KW/ref=sspa\\_dk\\_detail\\_4?pf\\_rd\\_p=bff6e147-54ad-4be3-b4ea-ec19ea6167f7&pf\\_rd\\_r=3F5J6XR06E1TPJJ1B1%E2%80%A6](https://www.amazon.com/dp/B0B2J1J1KW/ref=sspa_dk_detail_4?pf_rd_p=bff6e147-54ad-4be3-b4ea-ec19ea6167f7&pf_rd_r=3F5J6XR06E1TPJJ1B1%E2%80%A6) (Year: 2022).\*

Farmly Portable Electric Fencing Net, available in <https://www.amazon.com/>, posted: Jun. 15, 2019 [online], [site visited Sep. 20, 2022], Internet URL: [https://www.amazon.com/dp/B07R9HQ6VH/ref=sspa\\_dk\\_detail\\_2?pd\\_rd\\_i=B07R9HQ6VH&pd\\_rd\\_w=bzfAF&content-id=amzn1.sym.46bad5f6-1f0a-%E2%80%A6/10](https://www.amazon.com/dp/B07R9HQ6VH/ref=sspa_dk_detail_2?pd_rd_i=B07R9HQ6VH&pd_rd_w=bzfAF&content-id=amzn1.sym.46bad5f6-1f0a-%E2%80%A6/10) (Year: 2019).\*

\* cited by examiner

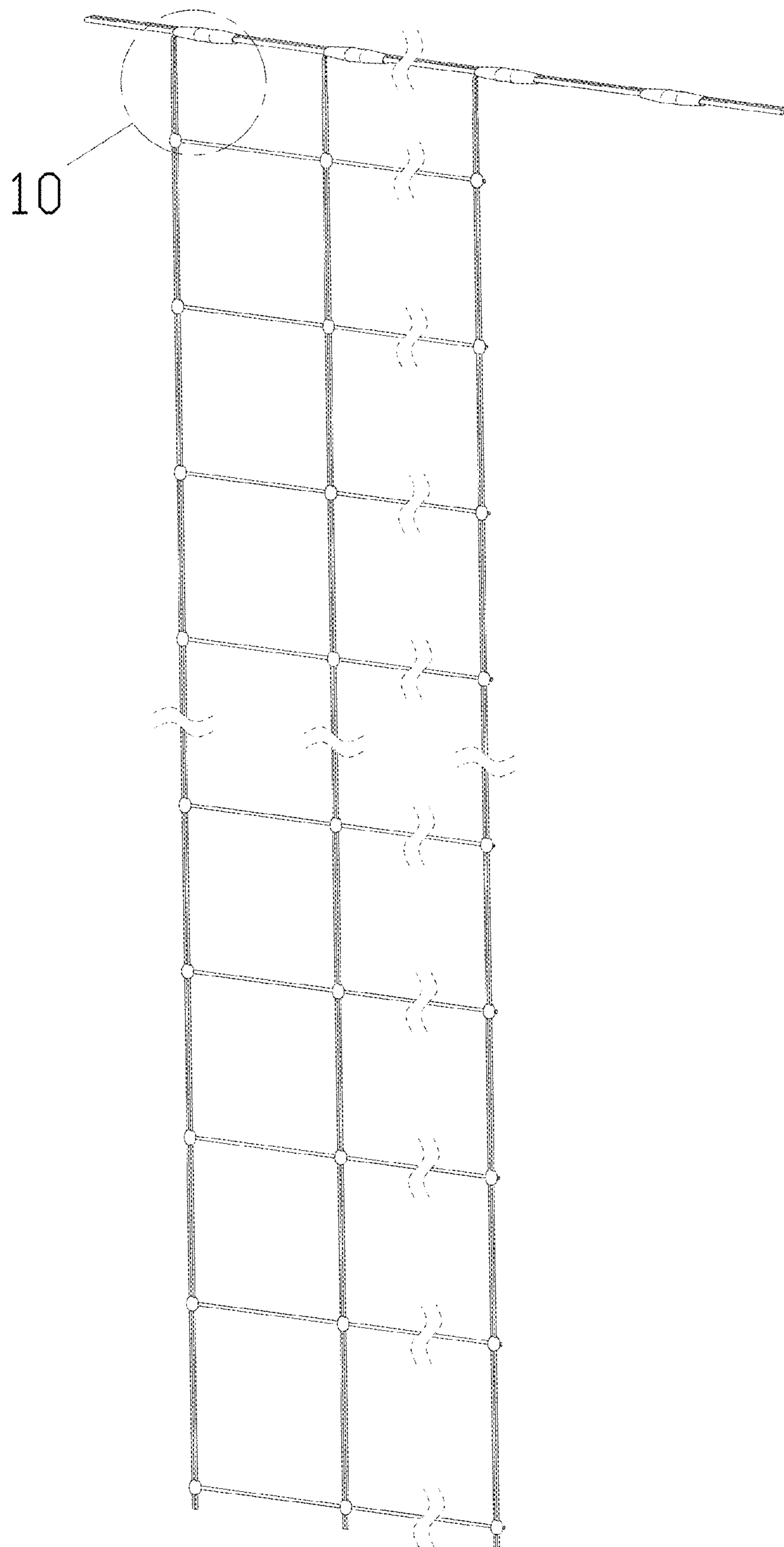

FIG. 1

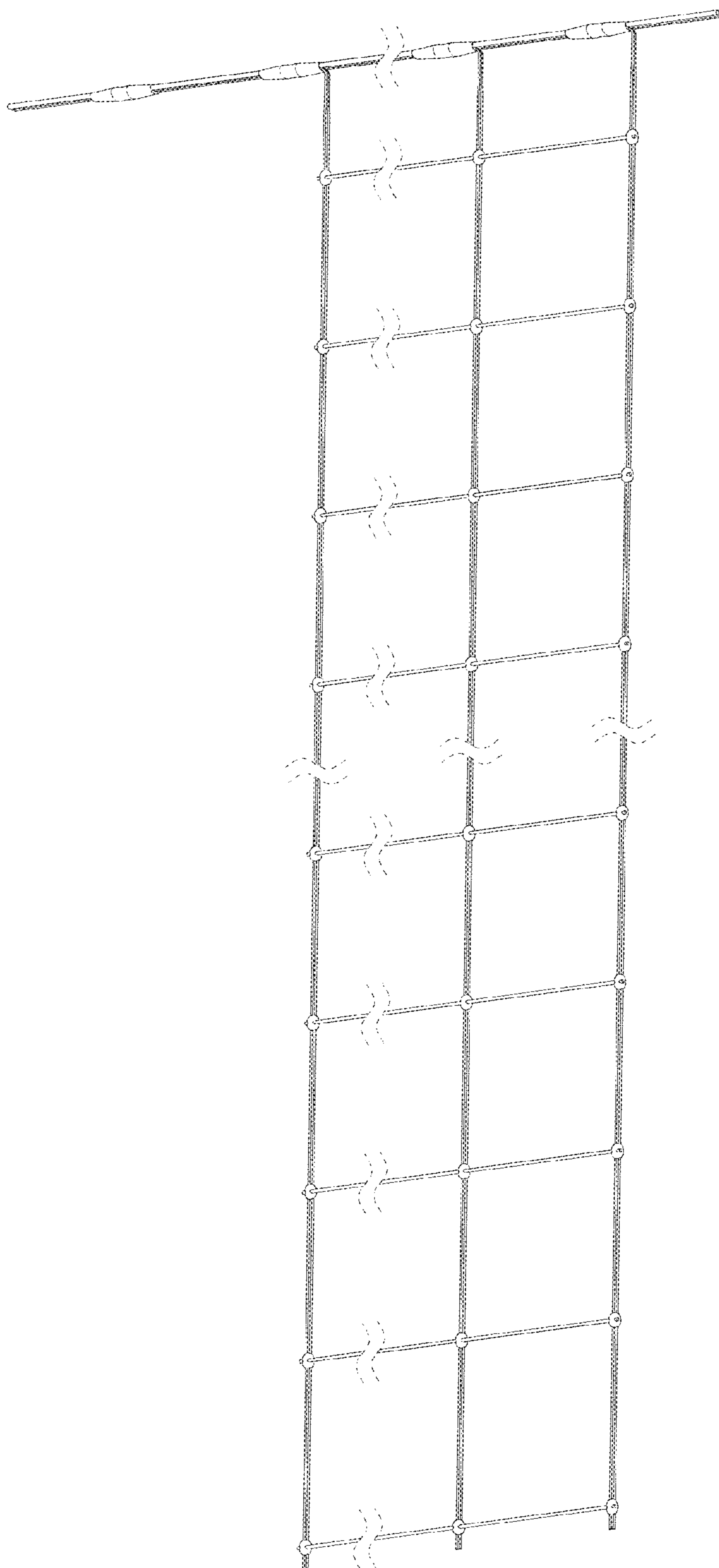

FIG. 2

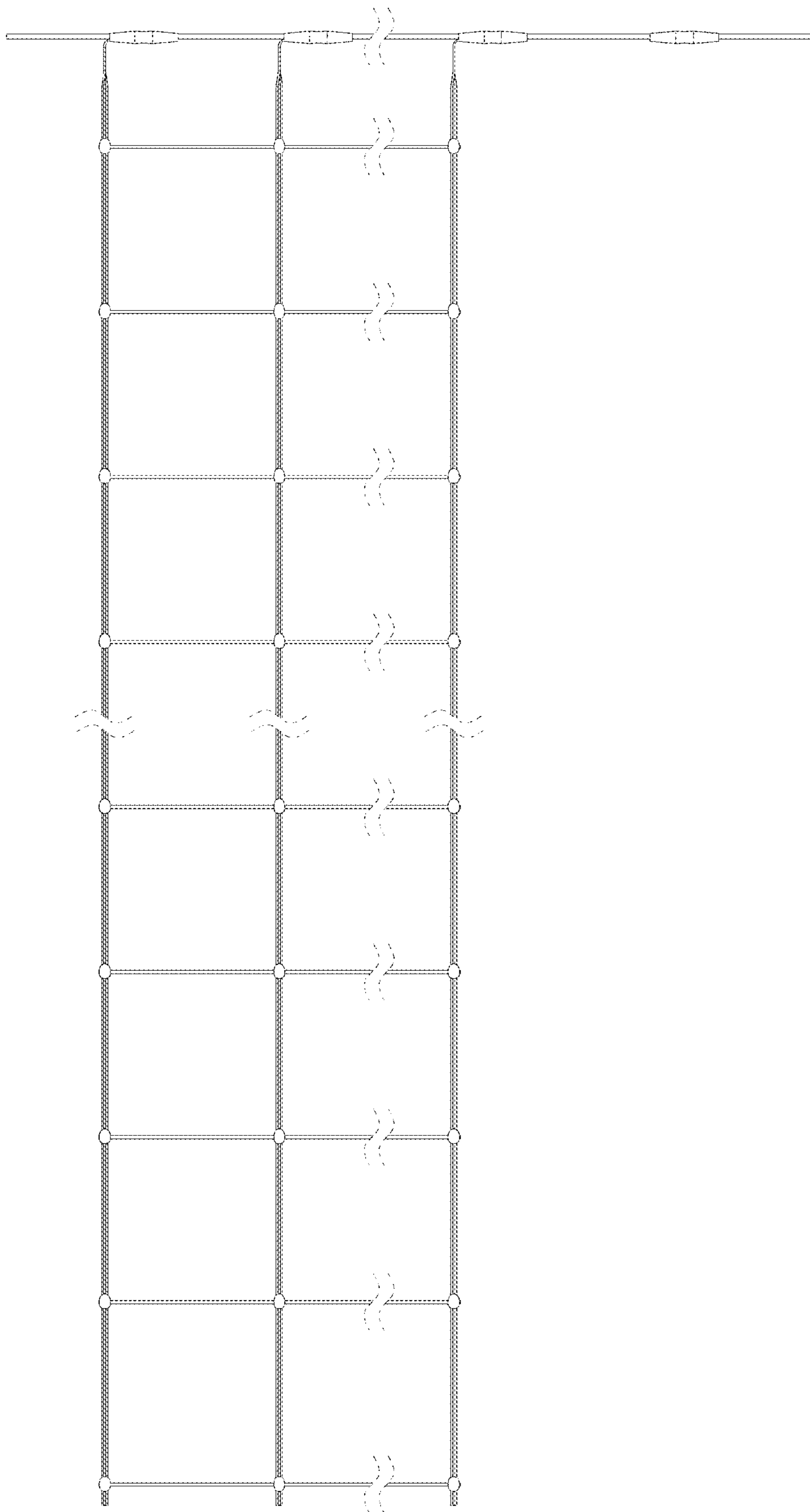

FIG. 3

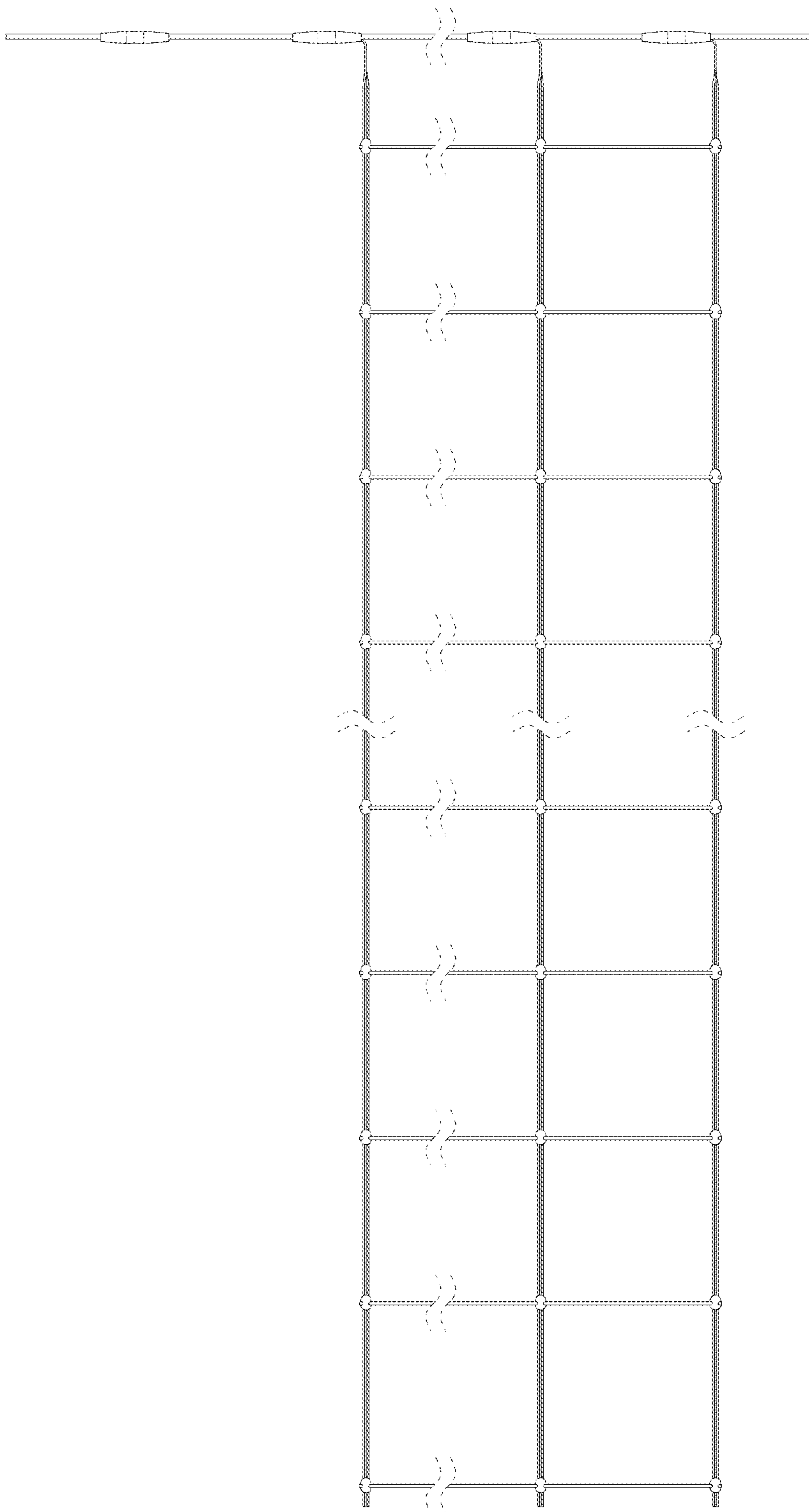

FIG. 4

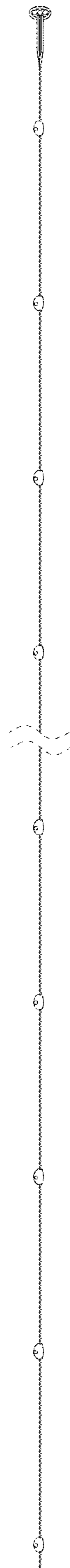

FIG. 5

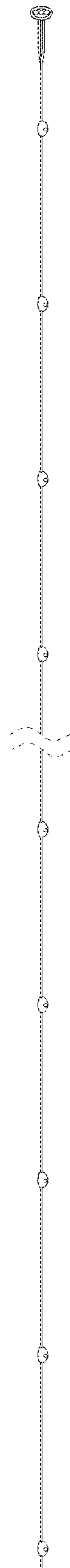

FIG. 6



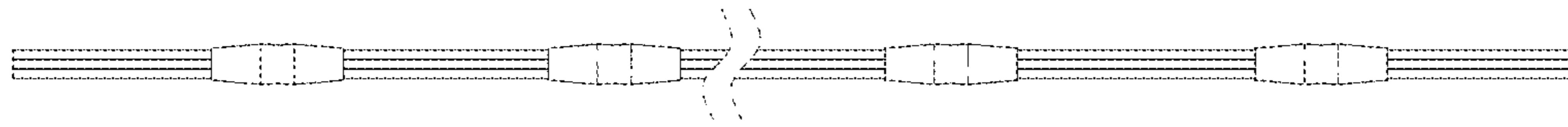

FIG. 7

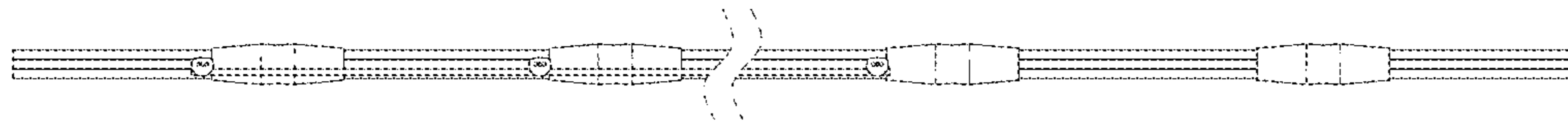

FIG. 8

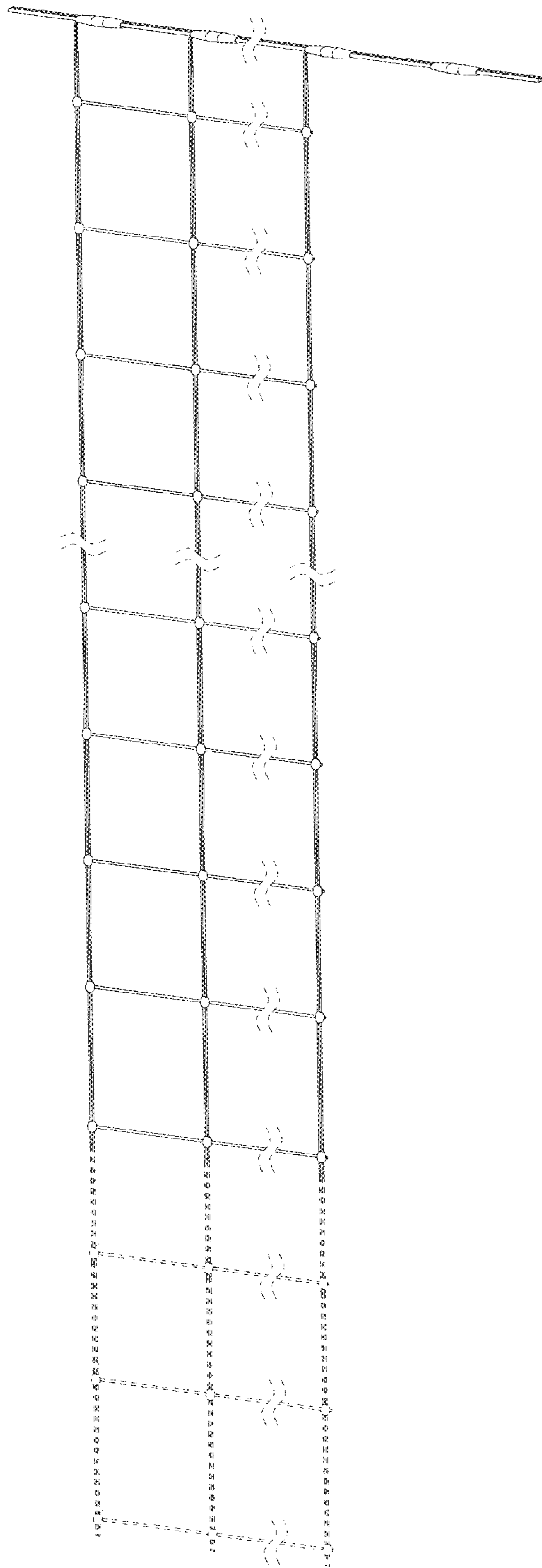

FIG. 9

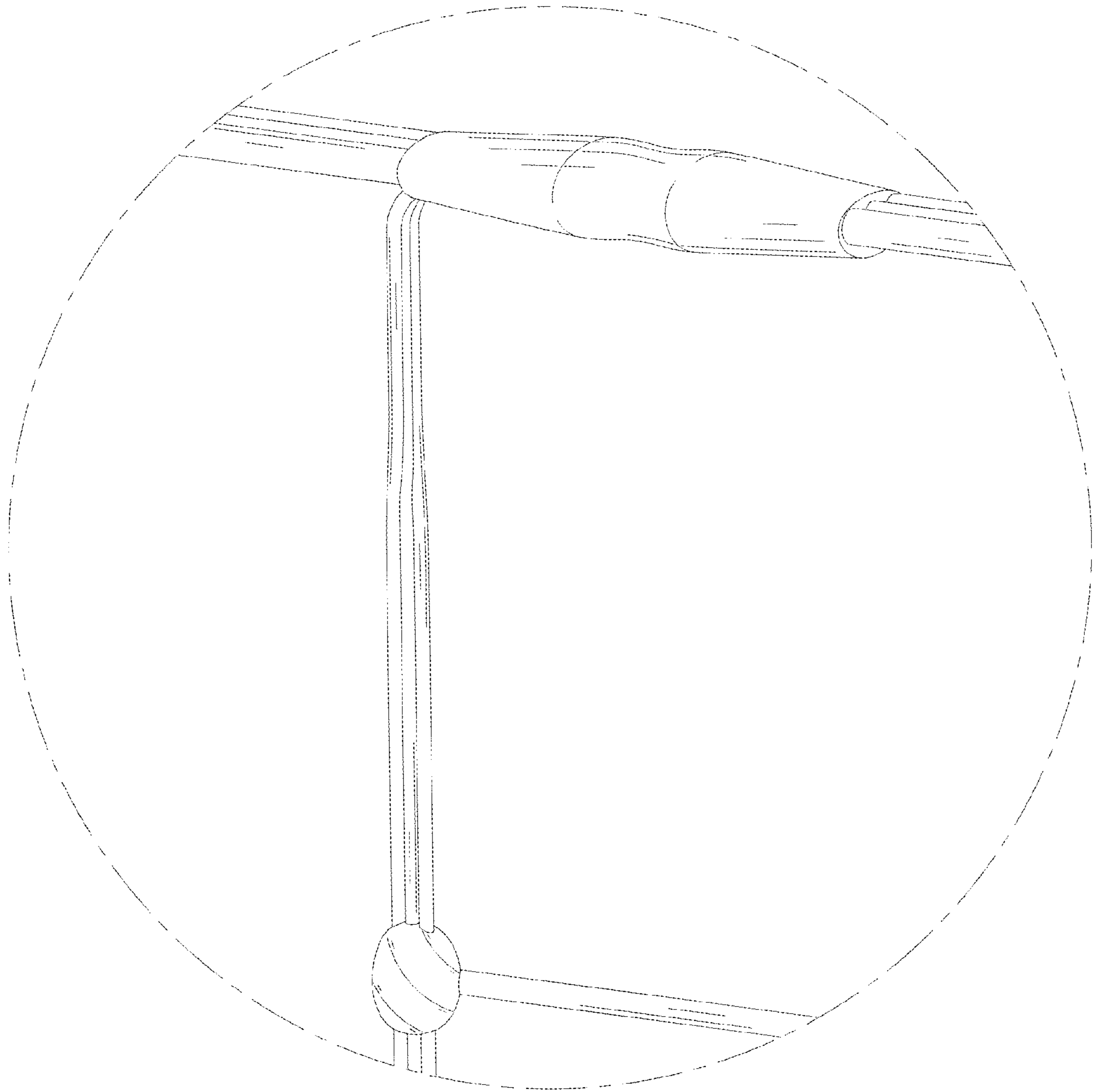

FIG. 10