



US00D970673S

(12) **United States Design Patent** (10) **Patent No.:** **US D970,673 S**
Guo (45) **Date of Patent:** **** Nov. 22, 2022**

(54) **TENT**
(71) Applicant: **Jintong Guo**, Xiamen (CN)
(72) Inventor: **Jintong Guo**, Xiamen (CN)
(**) Term: **15 Years**

(21) Appl. No.: **29/784,118**
(22) Filed: **May 18, 2021**
(51) **LOC (13) Cl.** **21-04**
(52) **U.S. Cl.**
USPC **D21/834**
(58) **Field of Classification Search**
USPC D21/834-839
CPC E04H 15/00; E04H 15/18; E04H 15/32;
E04H 15/58
See application file for complete search history.

(56) **References Cited**

U.S. PATENT DOCUMENTS

514,726	A *	2/1894	Ormsby	E04H 15/00 135/160
1,691,411	A *	11/1928	Roth	E04H 15/44 135/117
1,940,981	A *	12/1933	Tomlins	E04H 15/58 135/117
3,536,083	A *	10/1970	Reynolds	E04H 15/324 135/132
D224,761	S *	9/1972	Pohl et al.	D21/834
D224,850	S *	9/1972	Enzel et al.	D21/838
D369,638	S *	5/1996	Smith	D21/834
D601,653	S	10/2009	Kirkham		
D624,623	S	9/2010	Viglione		
D651,678	S	1/2012	Muggleton		
D682,381	S *	5/2013	Napieraj	D21/834
D695,375	S	12/2013	Jin		
9,371,664	B2 *	6/2016	Verheist	E04H 15/08
9,869,110	B2 *	1/2018	Krenzel	E04H 15/50
10,253,521	B2 *	4/2019	Choi	E04H 15/32

D919,734	S *	5/2021	Shields	D21/837
2004/0238021	A1 *	12/2004	Holub	E04H 15/30 135/97
2012/0186618	A1 *	7/2012	Arredondo	E04H 15/42 135/96

OTHER PUBLICATIONS

https://www.amazon.com/dp/B08FY9X73N?ref=myi_title_dp; Aug. 14, 2020.
https://www.amazon.com/dp/B08MDTJTZP?ref=myi_title_dp; Aug. 14, 2020.
https://www.amazon.com/dp/B08N1KM51Y?ref=myi_title_dp; Aug. 14, 2020.
https://www.amazon.com/dp/B091YZJZL9?ref=myi_title_dp; Aug. 14, 2020.
https://www.amazon.com/dp/B08ZSTR7L7?ref=myi_title_dp; Aug. 14, 2020.

(Continued)

Primary Examiner — Cynthia M. Chin
(74) *Attorney, Agent, or Firm* — Rumit Ranjit Kanakia

(57) **CLAIM**

The ornamental design for a tent, as shown and described.

DESCRIPTION

FIG. 1 is a front perspective view of a tent showing my new design;
FIG. 2 is a front view thereof;
FIG. 3 is a back view thereof;
FIG. 4 is a right-side view thereof;
FIG. 5 is a left-side view thereof;
FIG. 6 is a top view thereof;
FIG. 7 is a bottom view thereof; and,
FIG. 8 is another perspective view thereof, showing the tent in a partially closed configuration.

1 Claim, 5 Drawing Sheets

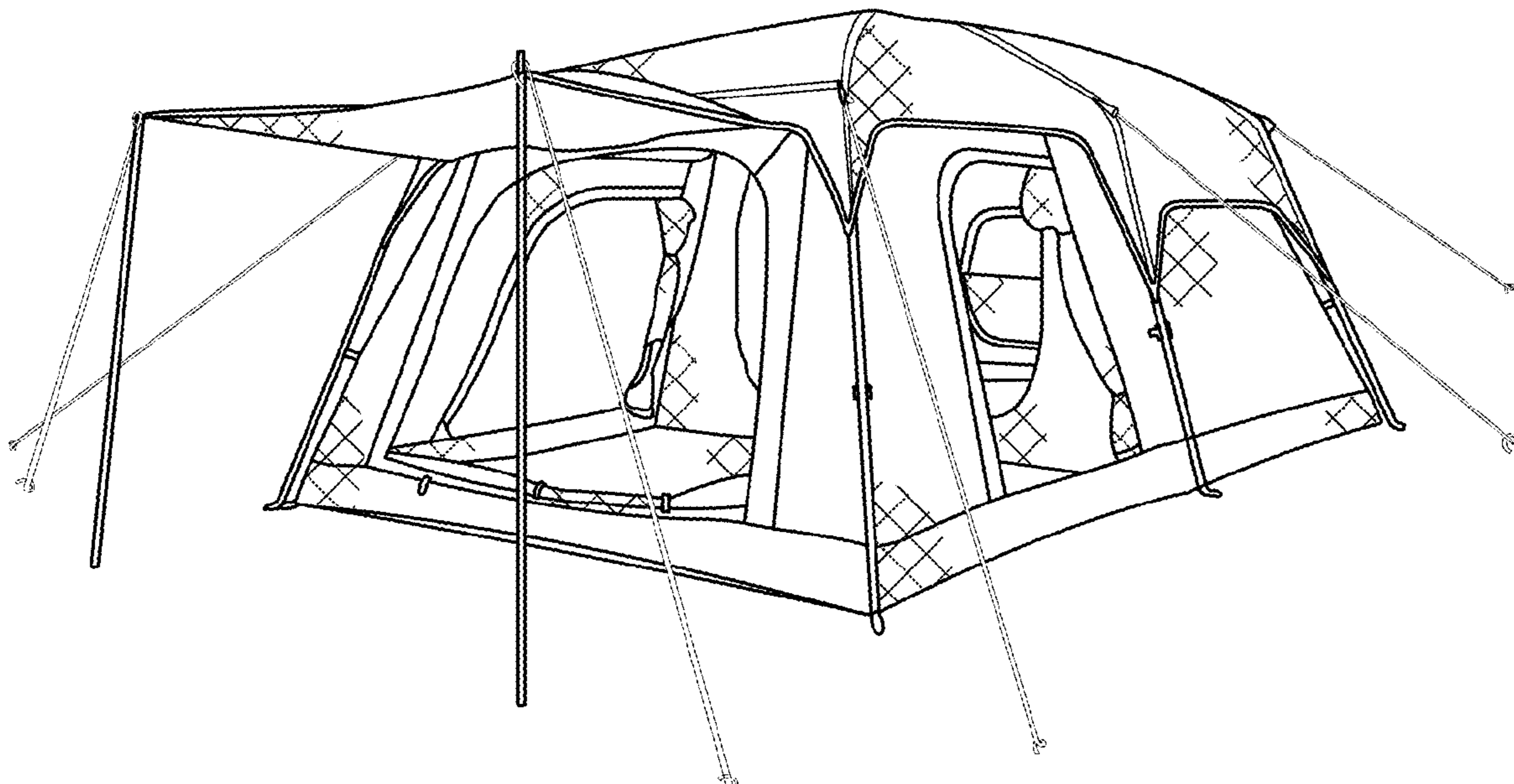

(56)

References Cited

OTHER PUBLICATIONS

https://www.amazon.com/dp/B08ZS3PX5K?ref=myi_title_dp; Aug. 14, 2020.

Tent,KTT Large Tent 8-10 Person,Family Cabin Tents,2 Rooms,Straight Wall,3 Doors and 3 Windows with Mesh,Waterproof,Double Layer,Big Tent for Outdoor,Picnic,Camping,Family,Friends Gathering,amazon.com,Aug. 14, 2022, https://www.amazon.com/dp/B08FY9X73N?ref=myi_title_dp (Last accessed: Aug. 17, 2022).

Tent,KTT Large Tent 8-10 Person,Family Cabin Tents,2 Rooms,Straight Wall,3 Doors and 3 Windows with Mesh,Waterproof, Double Layer,Big Tent for Outdoor,Picnic,Camping,Family,Friends Gathering,amazon.com, Nov. 2, 2022, https://www.amazon.com/dp/B08MDTJTZP?ref=myi_title_dp&th=1 (Last accessed: Aug. 17, 2022).

Tent,KTT Extra Large Tent 12 Person(Style-B),Family Cabin Tents,2 Rooms,Straight Wall,3 Doors and 3 Windows with Mesh,Waterproof,Double Layer,Big Tent for Outdoor,Picnic,Camping,Family,Friends Gathering, amazon.com, May 1, 2021, https://www.amazon.com/dp/B08N1KM51Y?ref=myi_title_dp&th=1 (Last accessed: Aug. 17, 2022).

Tent,KTT Large Tent 8-10 Person,Family Cabin Tents,2 Rooms,Straight Wall,3 Doors and 3 Windows with Mesh,Waterproof,Double Layer,Big Tent for Outdoor,Picnic,Camping,Family,Friends Gathering,amazon.com,Apr. 7, 2021, https://www.amazon.com/dp/B091YZJZL9?ref=myi_title_dp (Last accessed: Aug. 17, 2022).

Tent,KTT Large Tent 4-6 Person,Family Cabin Tents,Straight Wall,3 Doors and 3 Windows with Mesh,Waterproof,Big Tent for Outdoor,Picnic,Camping,Family,Friends Gathering . . . amazon.com, Feb. 28, 2022, https://www.amazon.com/dp/B09FQ6RCGY?ref=myi_title_dp&th=1 (Last accessed: Aug. 17, 2022).

* cited by examiner

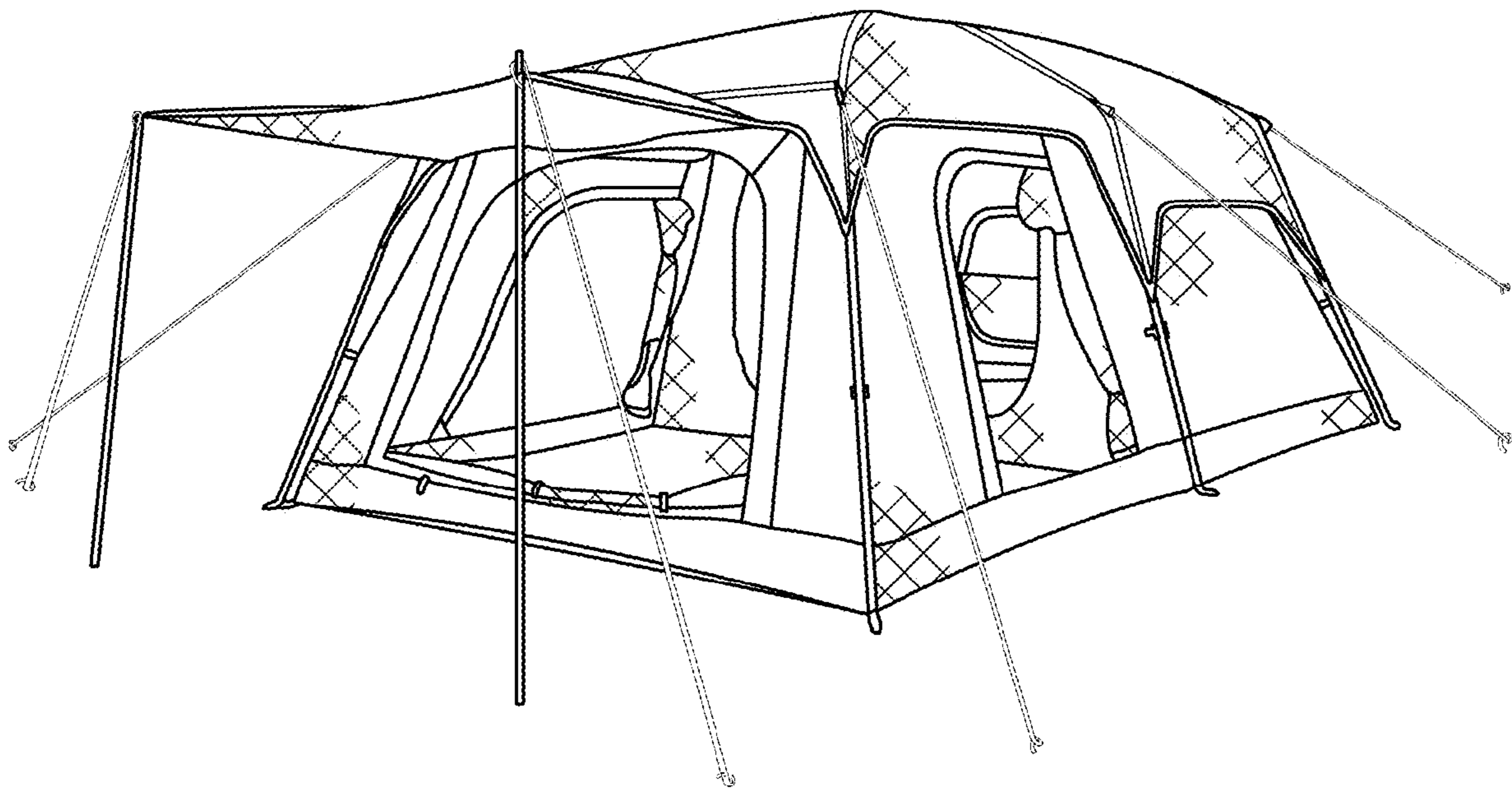

FIG. 1

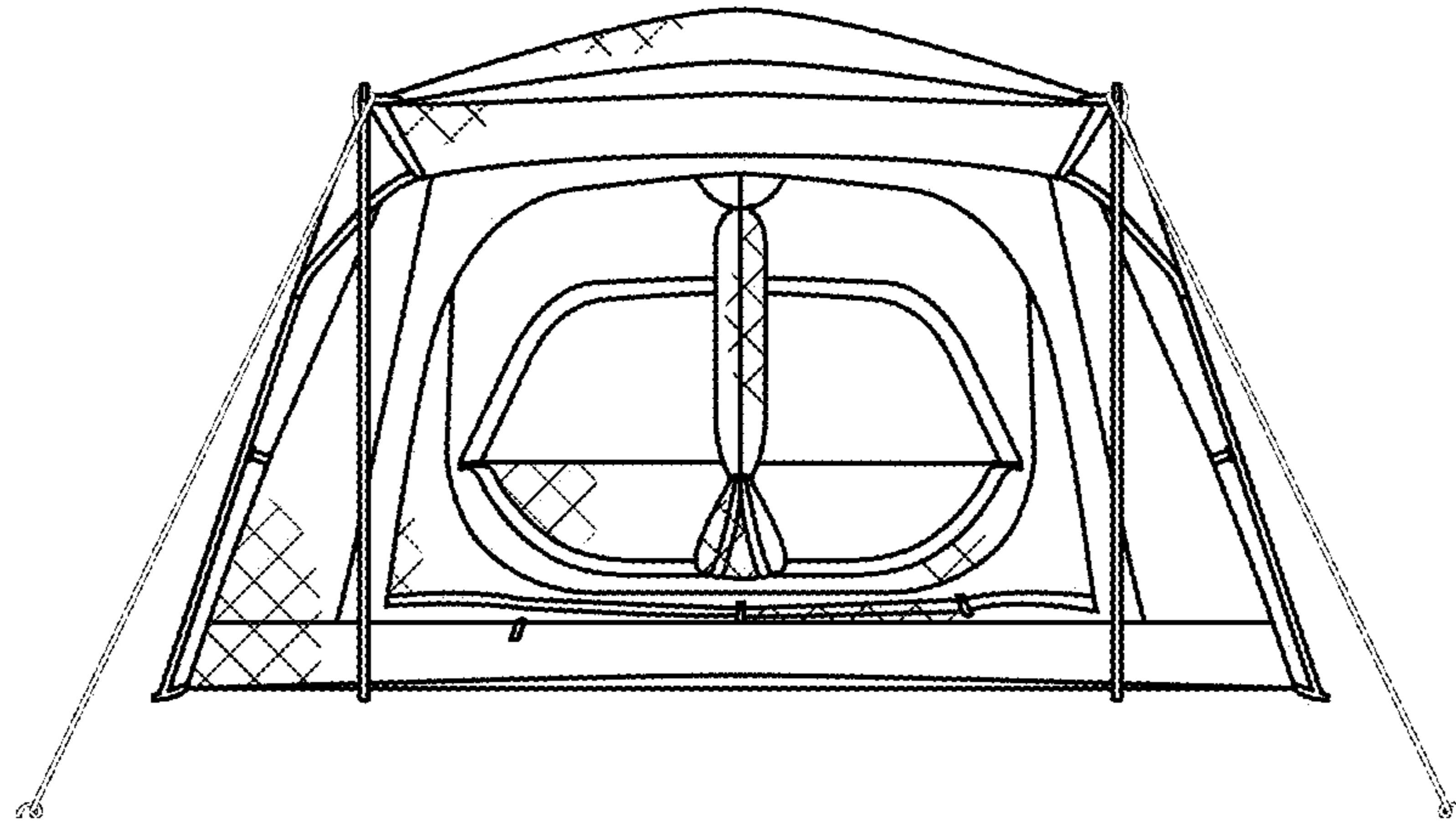

FIG. 2

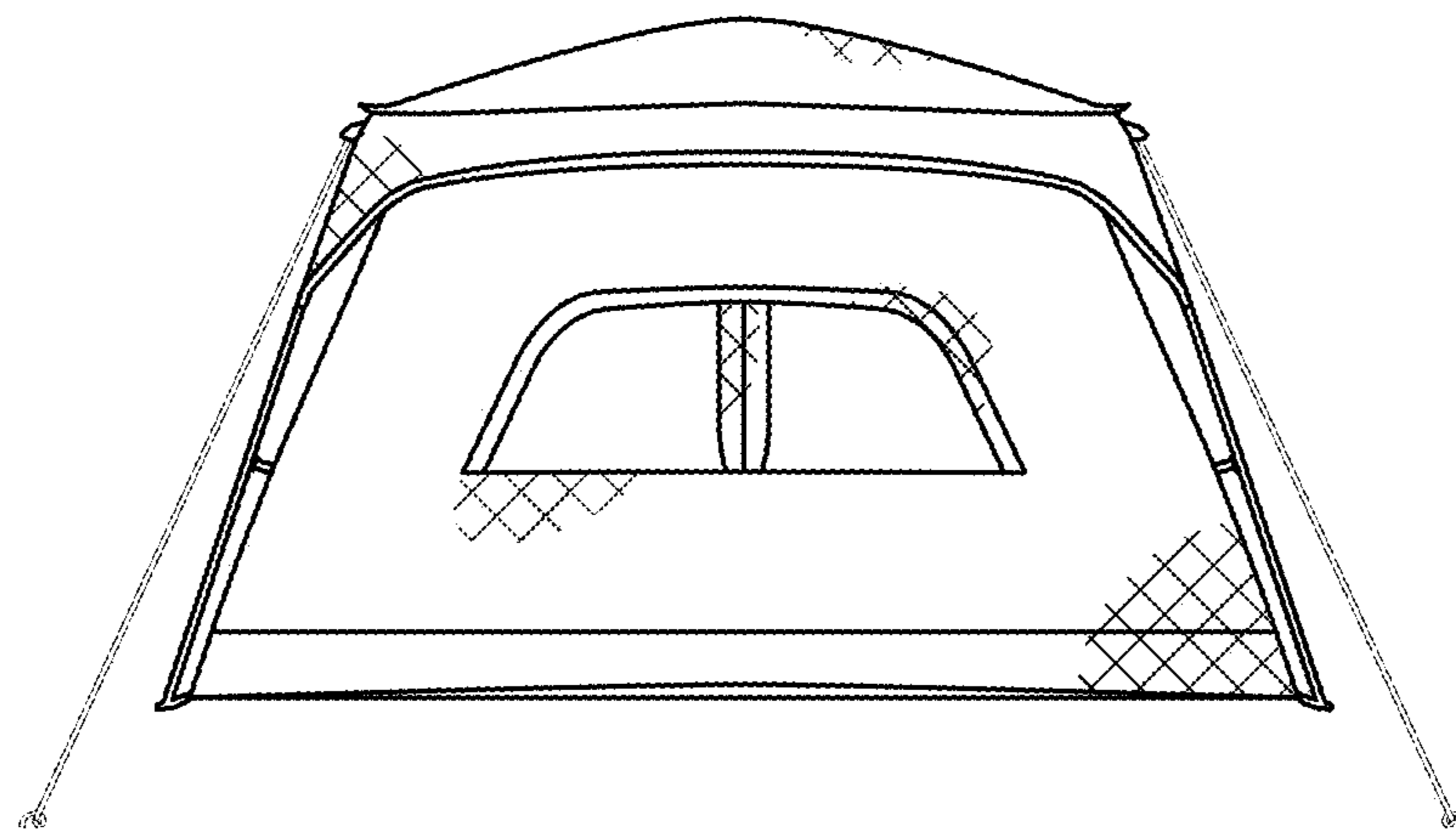

FIG. 3

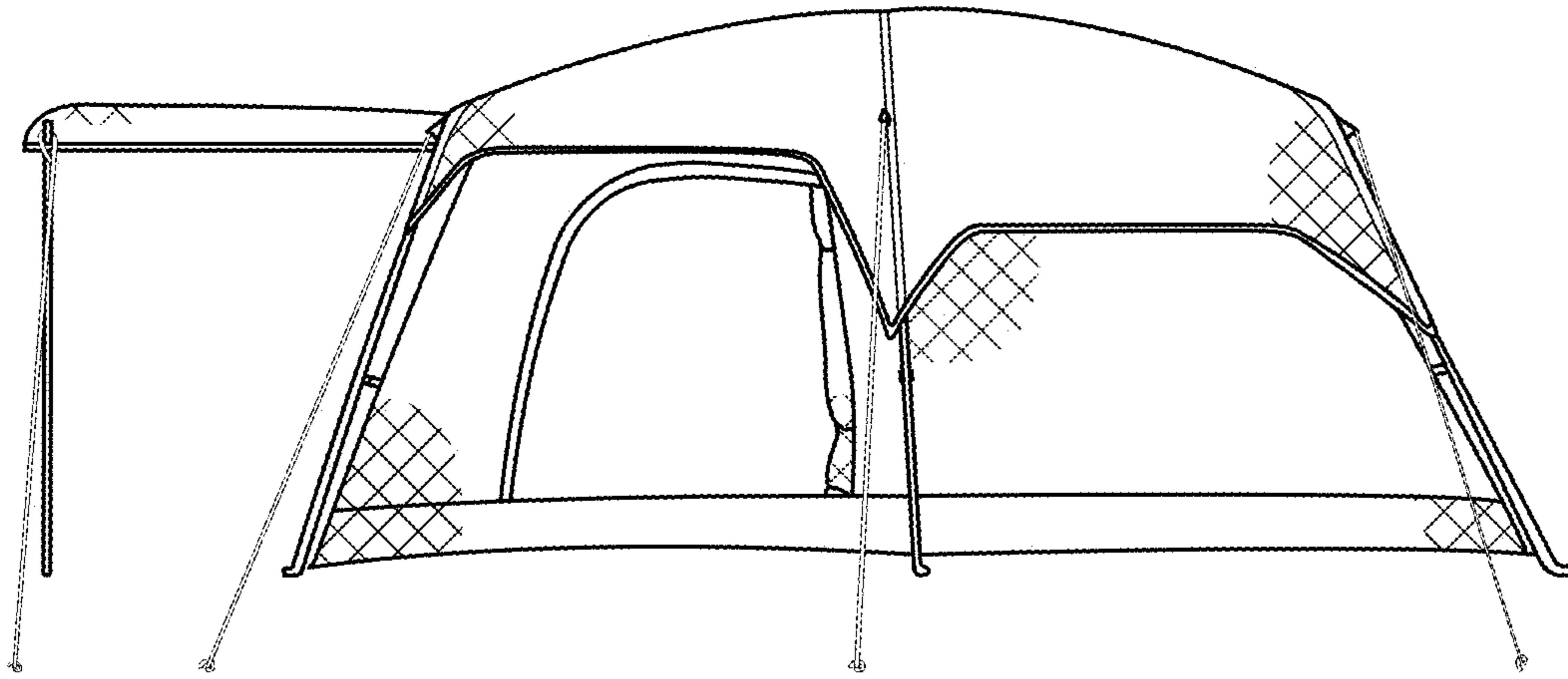

FIG. 4

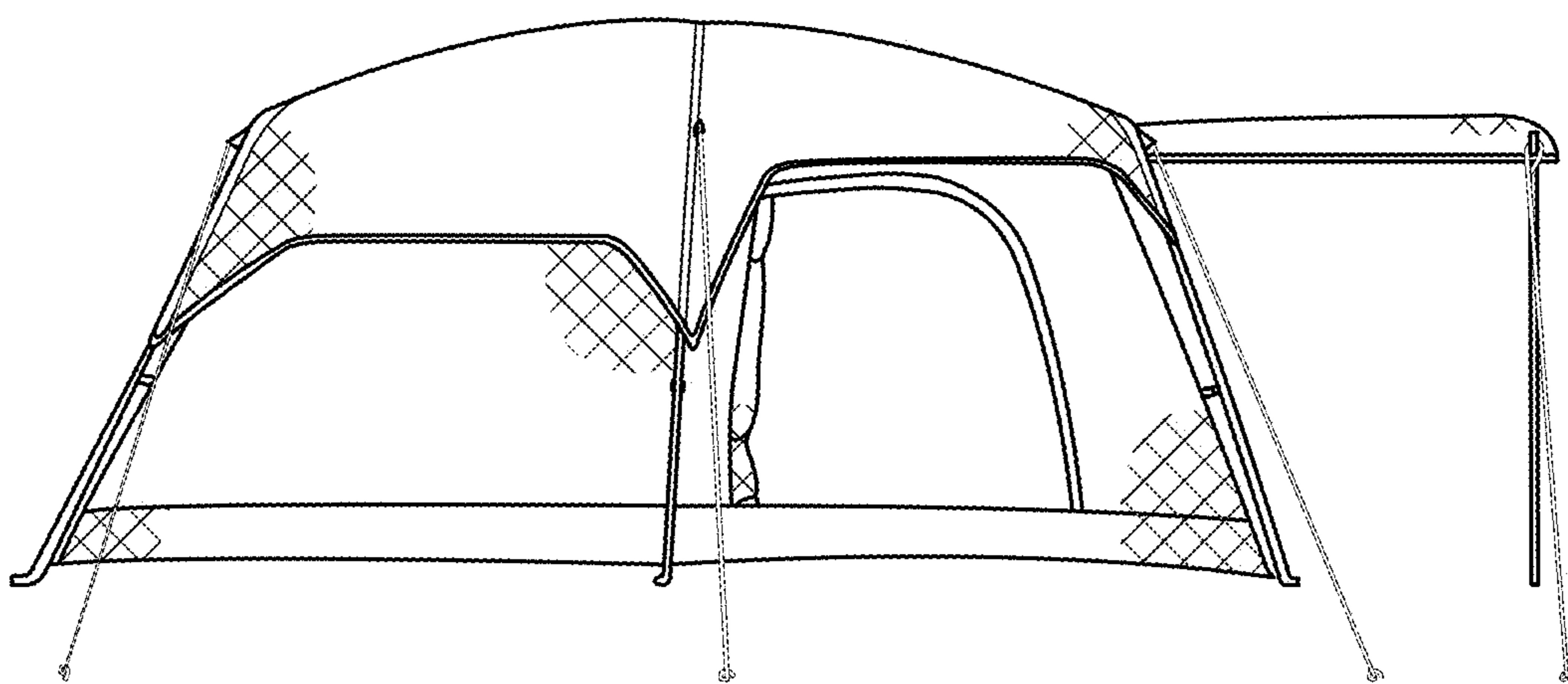

FIG. 5

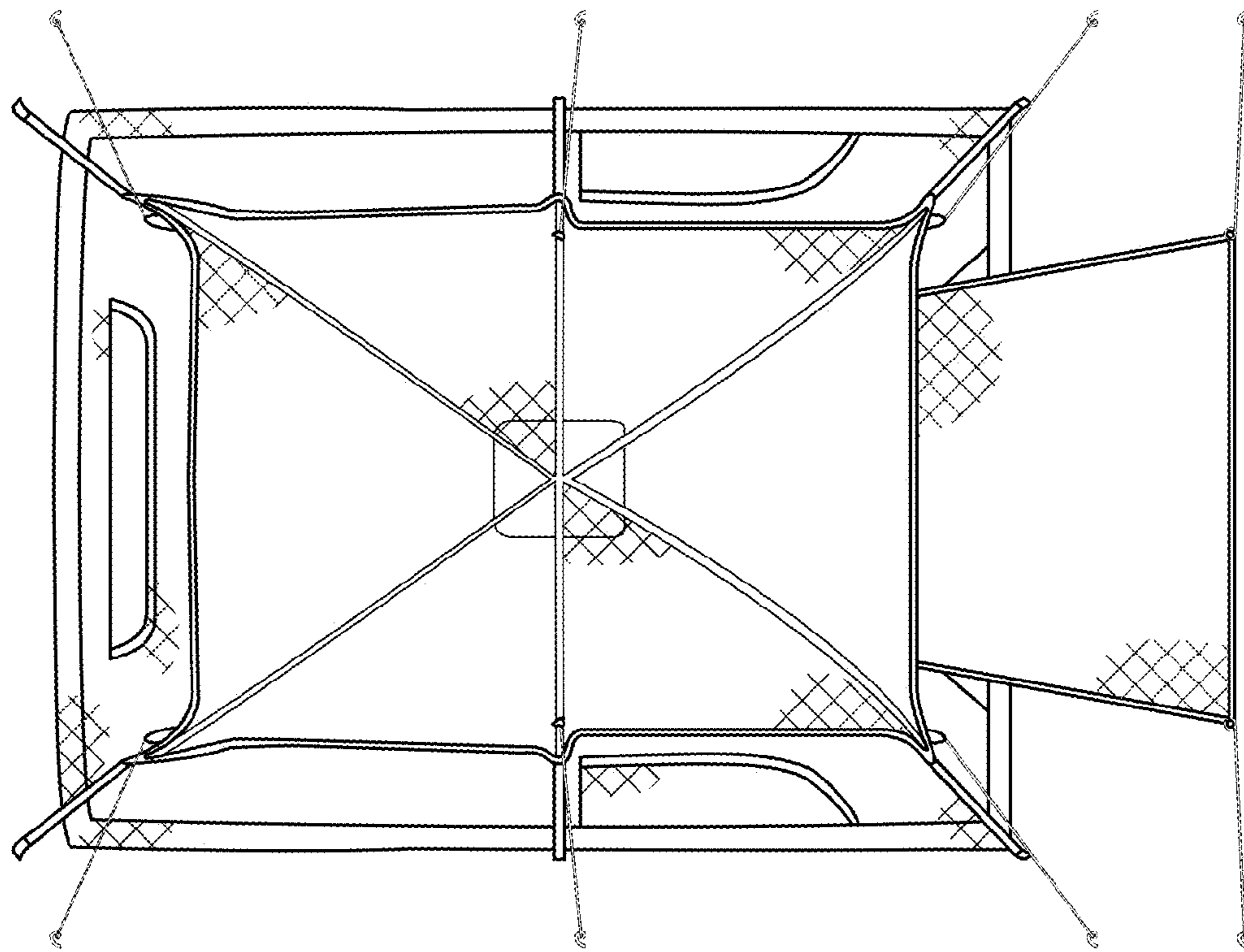

FIG. 6

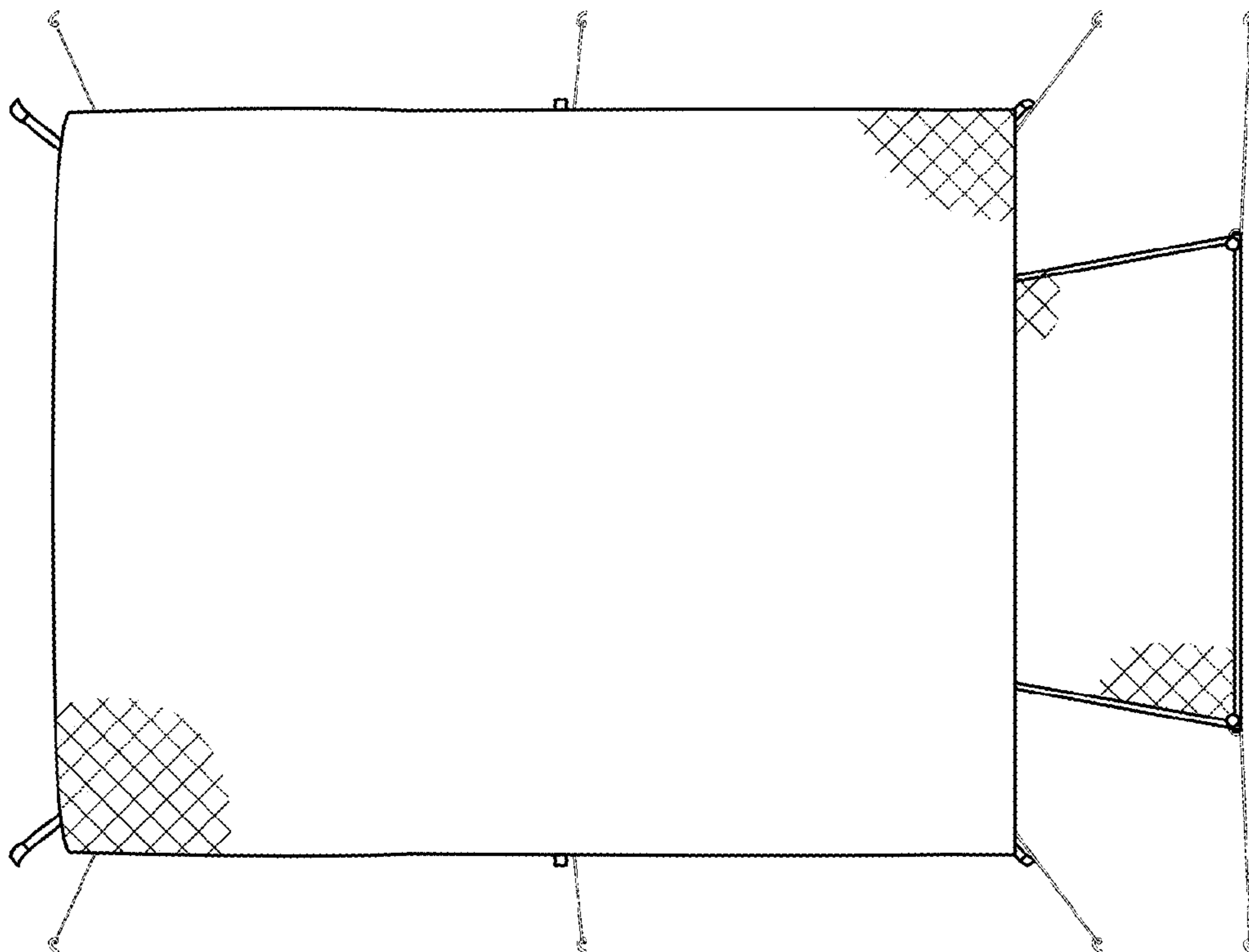

FIG. 7

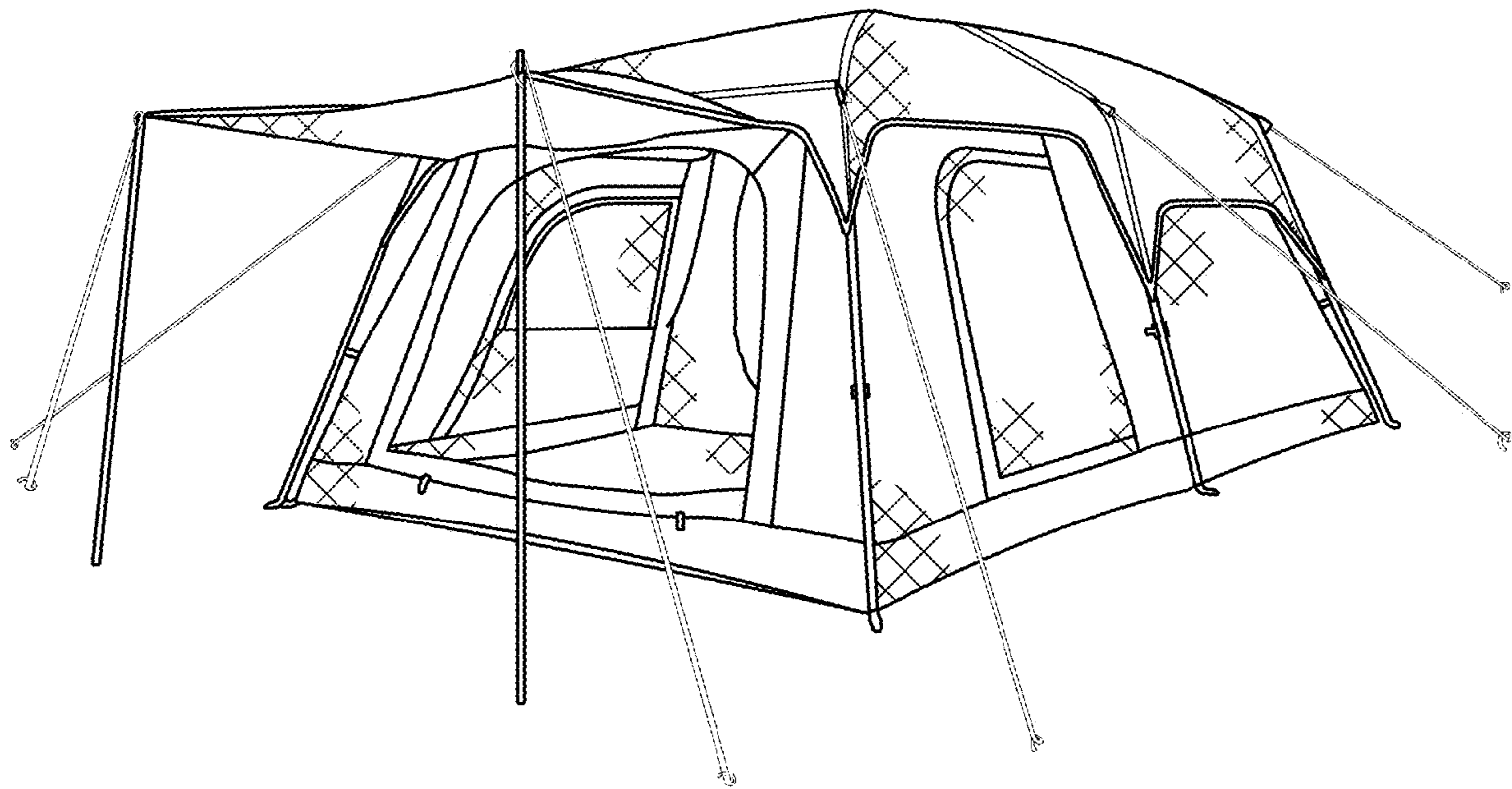

FIG. 8