



US00D970619S

(12) **United States Design Patent** (10) **Patent No.:** **US D970,619 S**  
**Ochs** (45) **Date of Patent:** **\*\* Nov. 22, 2022**

(54) **LUMINESCENT SIGN**  
(71) Applicant: **WELCOME TO THE BARK SIDE LLC**, Alpharetta, GA (US)  
(72) Inventor: **Stephen Ochs**, Atlanta, GA (US)  
(73) Assignee: **WELCOME TO THE BARK SIDE LLC**, Alpharetta, GA (US)

1,480,019 A 1/1924 Simpson  
1,501,102 A 7/1924 Duncan et al.  
1,509,014 A 9/1924 Young  
1,524,446 A 1/1925 Meacher  
1,570,980 A 1/1926 Wiegand  
1,672,285 A \* 6/1928 Schaefer ..... G09F 13/26  
313/515  
1,972,155 A \* 9/1934 McMaster ..... G09F 13/24  
40/406  
2,041,135 A \* 5/1936 Kaufman ..... G09F 13/24  
40/406

(\*\*) Term: **15 Years**  
(21) Appl. No.: **29/770,721**  
(22) Filed: **Feb. 16, 2021**

(Continued)

**Related U.S. Application Data**

(62) Division of application No. 29/668,101, filed on Oct. 26, 2018, now Pat. No. Des. 921,755.  
(51) **LOC (13) Cl.** ..... **20-03**  
(52) **U.S. Cl.**  
USPC ..... **D20/10; D20/19**  
(58) **Field of Classification Search**  
USPC ..... D6/325, 328; D8/315, 316, 354, 366,  
D8/371, 373, 380, 381, 400; D20/10, 12,  
D20/17, 19, 29, 30, 39, 42-44, 99;  
D25/119  
CPC ..... G09F 2007/1813; G09F 2007/1817; G09F  
2007/1821; G09F 2007/1826; G09F  
2007/1847; G09F 2007/186; G09F  
2007/1869; G09F 7/20; G09F 2007/1804;  
G09F 2007/183  
See application file for complete search history.

**OTHER PUBLICATIONS**

Bark, posted at whatnowatlanta.com, posted on Oct. 13, 2020, site visited Apr. 7, 2022. online, available from internet: <https://whatnowatlanta.com/fetch-park-buckhead-village-opening-winter-2021/> (Year: 2020).\*

(Continued)

*Primary Examiner* — Catherine Ho  
(74) *Attorney, Agent, or Firm* — Smith, Gambrell & Russell; Ryan A. Varnum

(57) **CLAIM**

The ornamental design for a luminescent sign, as shown and described.

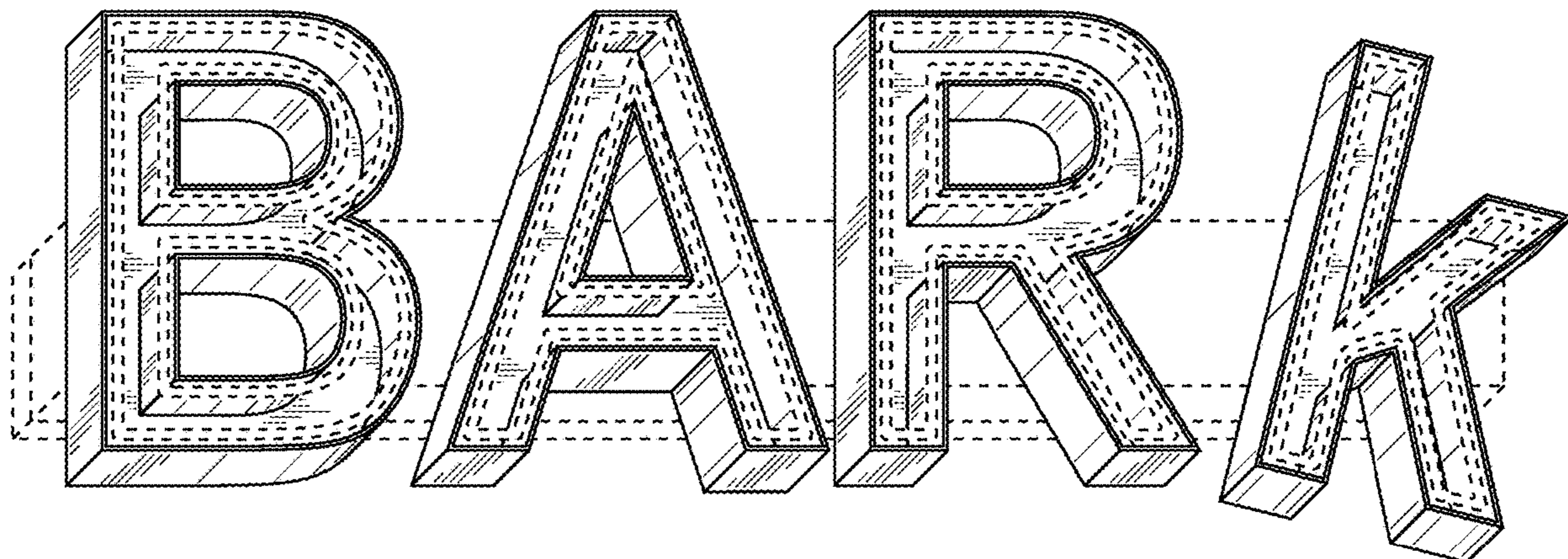
**DESCRIPTION**

FIG. 1 is a front perspective view of a luminescent sign showing my new design;  
FIG. 2 is a front view thereof;  
FIG. 3 is a back view thereof;  
FIG. 4 is a left-side view thereof;  
FIG. 5 is a right-side view thereof;  
FIG. 6 is a top view thereof; and,  
FIG. 7 is a bottom view thereof.

The dashed broken lines depict portions of the luminescent sign which form no part of the claimed design.

(56) **References Cited**  
U.S. PATENT DOCUMENTS  
1,341,251 A \* 5/1920 Arnold ..... G09F 7/08  
40/619  
1,346,499 A \* 7/1920 Limpert ..... G09F 13/0404  
40/579

**1 Claim, 7 Drawing Sheets**



(56)

References Cited

U.S. PATENT DOCUMENTS

2,066,549 A \* 1/1937 Tilles ..... H01R 33/02  
336/107  
2,119,157 A \* 5/1938 Fodor ..... G09F 13/26  
40/545  
2,130,023 A \* 9/1938 Owen ..... G09F 13/02  
40/563  
2,130,752 A \* 9/1938 Wagner ..... G09F 7/08  
40/576  
2,135,859 A \* 11/1938 Swanson ..... G02B 6/0001  
40/619  
2,165,835 A \* 7/1939 Brady ..... G09F 13/06  
359/545  
2,177,641 A \* 10/1939 Evans ..... G09F 13/00  
362/812  
2,186,982 A \* 1/1940 Mansell ..... G09F 13/26  
428/426  
2,220,618 A \* 11/1940 Tschopp ..... G09F 13/00  
248/50  
2,243,816 A \* 5/1941 Hammer ..... G09F 13/04  
362/311.03  
2,276,114 A \* 3/1942 Sture ..... G02B 6/0001  
40/619  
2,276,185 A \* 3/1942 Gauthier ..... G02B 6/0091  
40/619  
2,310,600 A \* 2/1943 Robinson ..... G09F 13/16  
362/334  
2,365,076 A \* 12/1944 Haywood, Jr. .... G02B 6/0001  
40/618  
2,405,266 A \* 8/1946 McFall ..... G09F 13/00  
40/620  
2,424,169 A \* 7/1947 Hoffman ..... G09F 13/00  
362/812  
2,488,169 A \* 11/1949 Browner ..... G09F 13/26  
313/325  
2,560,117 A \* 7/1951 Mallary ..... G02B 6/0091  
40/616  
2,603,898 A \* 7/1952 Patterson, Jr. .... G09F 13/00  
362/277  
2,637,926 A \* 5/1953 Anderson ..... G02B 6/0091  
439/208

2,823,474 A \* 2/1958 Hotchner ..... G09F 13/00  
40/545  
2,923,080 A \* 2/1960 Spangler ..... G09F 13/0404  
D18/26  
3,221,432 A \* 12/1965 Gold ..... G09F 13/0404  
D18/26  
3,254,436 A \* 6/1966 Bank ..... G09F 13/0404  
D18/24  
3,406,475 A 10/1968 O'Donnell  
3,550,298 A \* 12/1970 O'Neill ..... G09F 13/0404  
40/545  
3,755,943 A \* 9/1973 Cesarotti ..... G09F 13/0404  
40/552  
D247,070 S 1/1978 Mihojevich  
4,951,405 A \* 8/1990 Sabala ..... G09F 9/305  
40/551  
5,099,593 A 3/1992 Hannula  
5,146,704 A 9/1992 Dugan  
5,832,642 A \* 11/1998 Dalton ..... G09F 13/18  
362/812  
D863,443 S \* 10/2019 Smith ..... D20/42  
D921,755 S \* 6/2021 Ochs ..... D20/10  
2005/0060922 A1 \* 3/2005 Nimmer ..... G09F 9/313  
40/606.01  
2014/0369041 A1 12/2014 Fallon  
2019/0160512 A1 5/2019 Lim  
2020/0138003 A1 5/2020 Shoemaker, Jr.

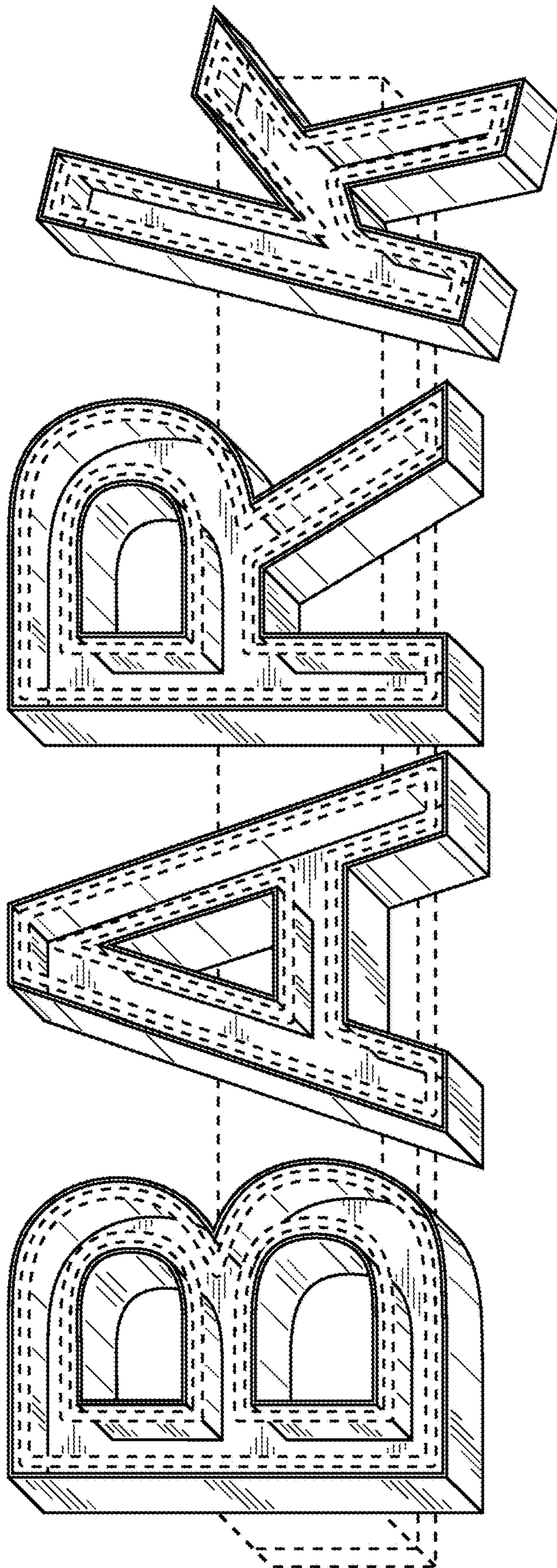
OTHER PUBLICATIONS

Fetch, posted at [ajc.com](https://www.ajc.com), posted on Oct. 13, 2020, site visited Apr. 7, 2022. online, available from internet: <https://www.ajc.com/things-to-do/atlanta-restaurant-blog/off-leash-dog-park-bar-fetch-to-open-in-buckhead-in-2021/KVSPQV2YUFELFKOQIT54O7WZNA/> (Year: 2020).\*

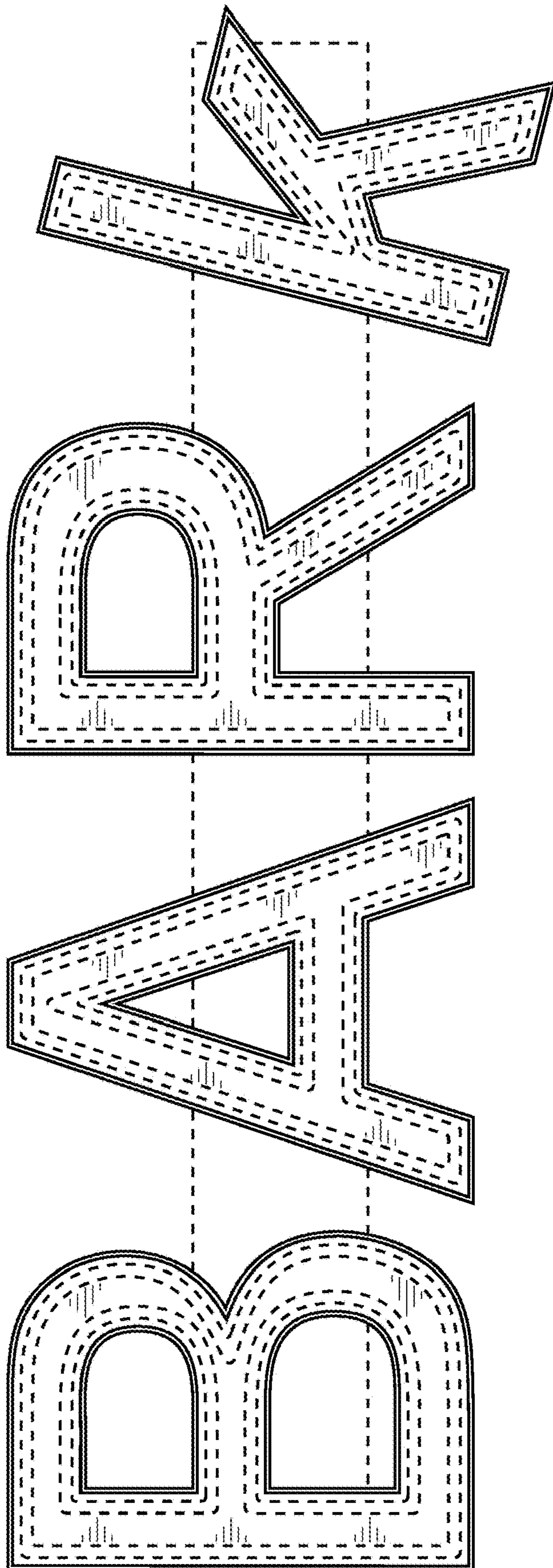
Fetch, posted at [Atlanta.curbed.com](https://atlanta.curbed.com), posted on Feb. 2, 2017, site visited Jul. 30, 2020. online, available from internet: <https://atlanta.curbed.com/2017/2/2/14489512/fetch-old-fourth-ward-dog-park-restaurant-renderings> (Year: 2017).

\* cited by examiner

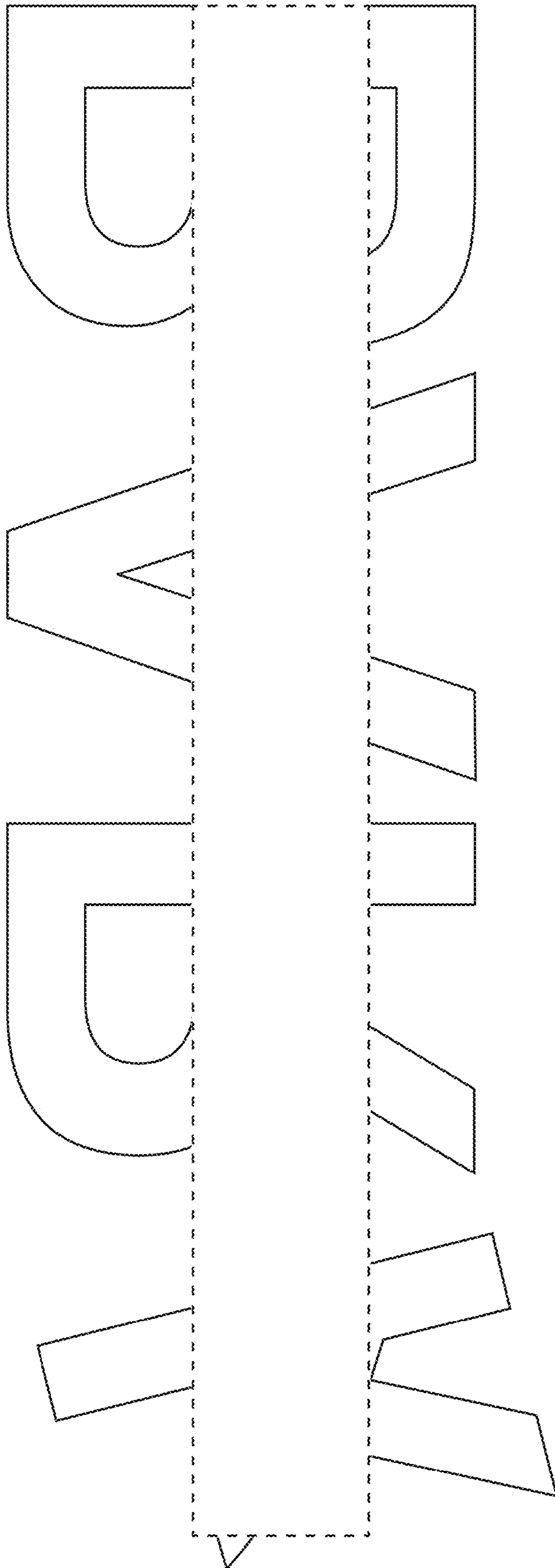




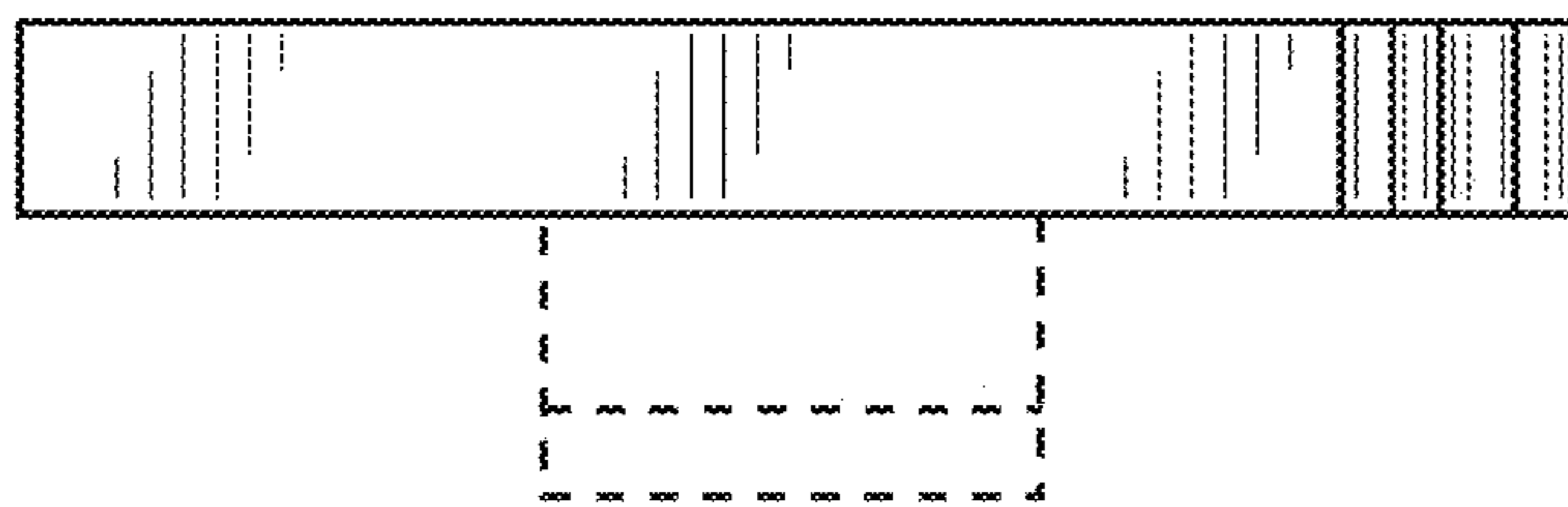
**FIG. 1**



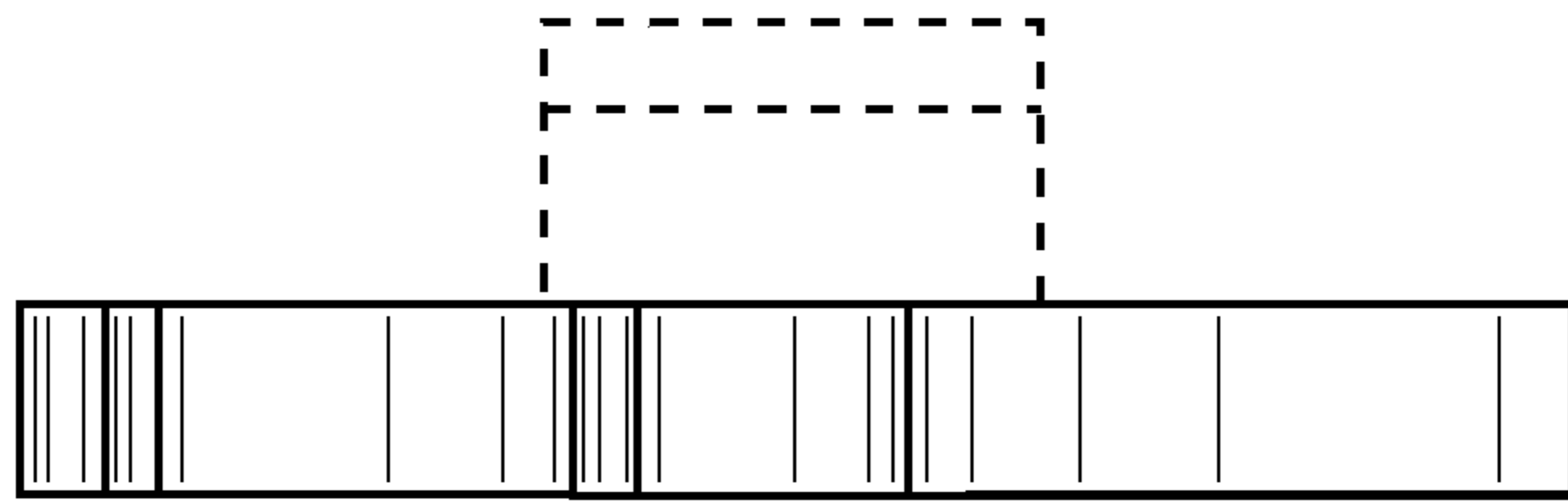
**FIG. 2**



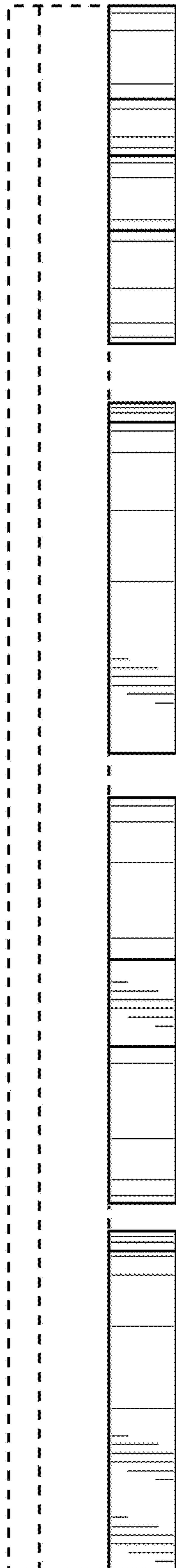
**FIG. 3**



**FIG. 4**

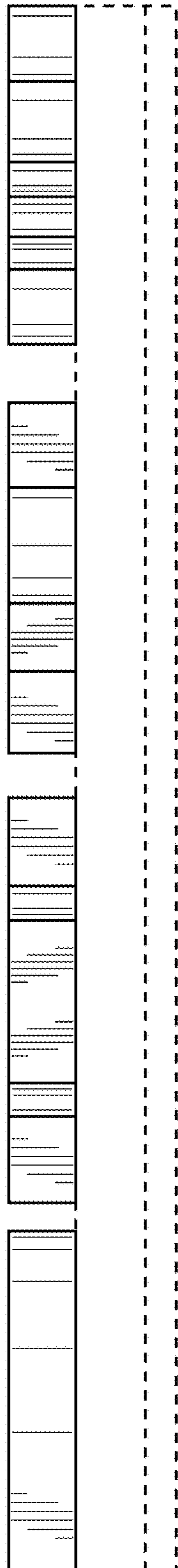


**FIG. 5**



**FIG. 6**





**FIG. 7**