

US00D970509S

(12) **United States Design Patent**
Liu et al.

(10) **Patent No.:** **US D970,509 S**
(45) **Date of Patent:** **** Nov. 22, 2022**

(54) **PROTECTIVE CASE FOR TABLET COMPUTER**

(71) Applicant: **Electronic Silk Road (Shenzhen) Tech Co., Ltd.**, Shenzhen (CN)

(72) Inventors: **Xing Liu**, Shenzhen (CN); **Xinyu Chen**, Fuzhou (CN)

(**) Term: **15 Years**

(21) Appl. No.: **29/765,144**

(22) Filed: **Jan. 6, 2021**

(51) **LOC (13) Cl.** **14-02**

(52) **U.S. Cl.**
USPC **D14/440**

(58) **Field of Classification Search**
USPC D14/440, 250, 447; 206/45.2, 45.23, 206/320; 361/679.55; 294/25; 224/218
(Continued)

(56) **References Cited**

U.S. PATENT DOCUMENTS

D689,498 S * 9/2013 Akana D14/440
D691,611 S * 10/2013 Kirzinger D14/440
(Continued)

Primary Examiner — Katie Jane Stofko

(74) *Attorney, Agent, or Firm* — Sandy Lipkin

(57) **CLAIM**

The ornamental design for a protective case for tablet computer, as shown and described.

DESCRIPTION

FIG. 1 is a front elevation view of a protective case for tablet computer showing the new design according to a first embodiment;

FIG. 2 is a rear elevation view thereof;

FIG. 3 is a left side elevation view thereof;

FIG. 4 is a right side elevation view thereof;

FIG. 5 is a top plan view thereof;

FIG. 6 is a bottom plan view thereof;

FIG. 7 is a perspective view thereof;

FIG. 8 is a front elevation view of a protective case for tablet computer showing the new design according to a second embodiment;

FIG. 9 is a rear elevation view thereof;

FIG. 10 is a left side elevation view thereof;

FIG. 11 is a right side elevation view thereof;

FIG. 12 is a top plan view thereof;

FIG. 13 is a bottom plan view thereof;

FIG. 14 is a perspective view thereof;

FIG. 15 is a front elevation view of a protective case for tablet computer showing the new design according to a third embodiment;

FIG. 16 is a rear elevation view thereof;

FIG. 17 is a left side elevation view thereof;

FIG. 18 is a right side elevation view thereof;

FIG. 19 is a top plan view thereof;

FIG. 20 is a bottom plan view thereof;

FIG. 21 is a perspective view thereof;

FIG. 22 is a front elevation view of a protective case for tablet computer showing the new design according to a fourth embodiment;

FIG. 23 is a rear elevation view thereof;

FIG. 24 is a left side elevation view thereof;

FIG. 25 is a right side elevation view thereof;

FIG. 26 is a top plan view thereof;

FIG. 27 is a bottom plan view thereof;

FIG. 28 is a perspective view thereof;

FIG. 29 is a front elevation view of a protective case for tablet computer showing the new design according to a fifth embodiment;

FIG. 30 is a rear elevation view thereof;

FIG. 31 is a left side elevation view thereof;

FIG. 32 is a right side elevation view thereof;

FIG. 33 is a top plan view thereof;

FIG. 34 is a bottom plan view thereof;

FIG. 35 is a perspective view thereof;

FIG. 36 is a front elevation view of a protective case for tablet computer showing the new design according to a sixth embodiment;

FIG. 37 is a rear elevation view thereof;

(Continued)

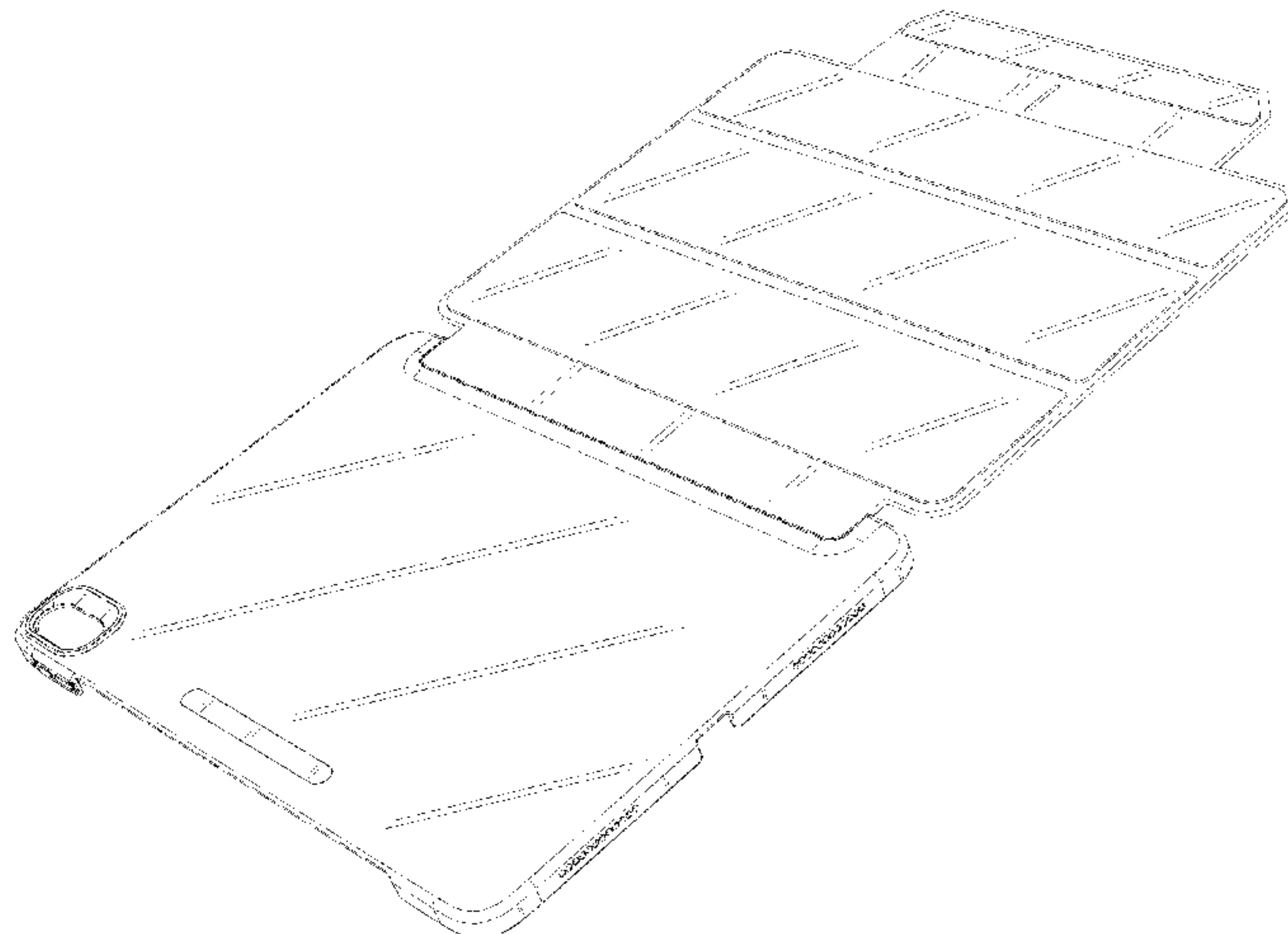

FIG. 38 is a left side elevation view thereof;
 FIG. 39 is a right side elevation view thereof;
 FIG. 40 is a top plan view thereof;
 FIG. 41 is a bottom plan view thereof;
 FIG. 42 is a perspective view thereof;
 FIG. 43 is a front elevation view of a protective case for tablet computer showing the new design according to a seventh embodiment;
 FIG. 44 is a rear elevation view thereof;
 FIG. 45 is a left side elevation view thereof;
 FIG. 46 is a right side elevation view thereof;
 FIG. 47 is a top plan view thereof;
 FIG. 48 is a bottom plan view thereof;
 FIG. 49 is a perspective view thereof;
 FIG. 50 is a front elevation view of a protective case for tablet computer showing the new design according to an eighth embodiment;
 FIG. 51 is a rear elevation view thereof;
 FIG. 52 is a left side elevation view thereof;
 FIG. 53 is a right side elevation view thereof;
 FIG. 54 is a top plan view thereof;
 FIG. 55 is a bottom plan view thereof; and,
 FIG. 56 is a perspective view thereof.

1 Claim, 56 Drawing Sheets

(58) **Field of Classification Search**

CPC ... G06F 1/1628; G06F 1/1626; A47B 23/044;
 H04B 1/3888

See application file for complete search history.

(56) **References Cited**

U.S. PATENT DOCUMENTS

D701,205	S	*	3/2014	Akana	D14/341
D723,041	S	*	2/2015	Kim	D14/440
D723,568	S	*	3/2015	Kim	D14/440
D727,919	S	*	4/2015	Melmon	D14/440
D752,593	S	*	3/2016	Diebel	G06F 1/1628 D14/440
D765,086	S	*	8/2016	Lee	D14/440
D864,972	S	*	10/2019	Chen	D14/440
D887,415	S	*	6/2020	Claudepierre	D14/440
D942,459	S	*	2/2022	Akana	D14/440
D947,855	S	*	4/2022	Akana	D14/444
2009/0194209	A1	*	8/2009	De Filippis	A45C 11/00 206/320
2014/0246340	A1	*	9/2014	Jiang	A45C 11/00 206/45.23
2015/0263776	A1	*	9/2015	Shyu	A45C 13/002 455/575.8
2015/0266610	A1	*	9/2015	Melmon	G06F 1/1626 206/45.23

* cited by examiner

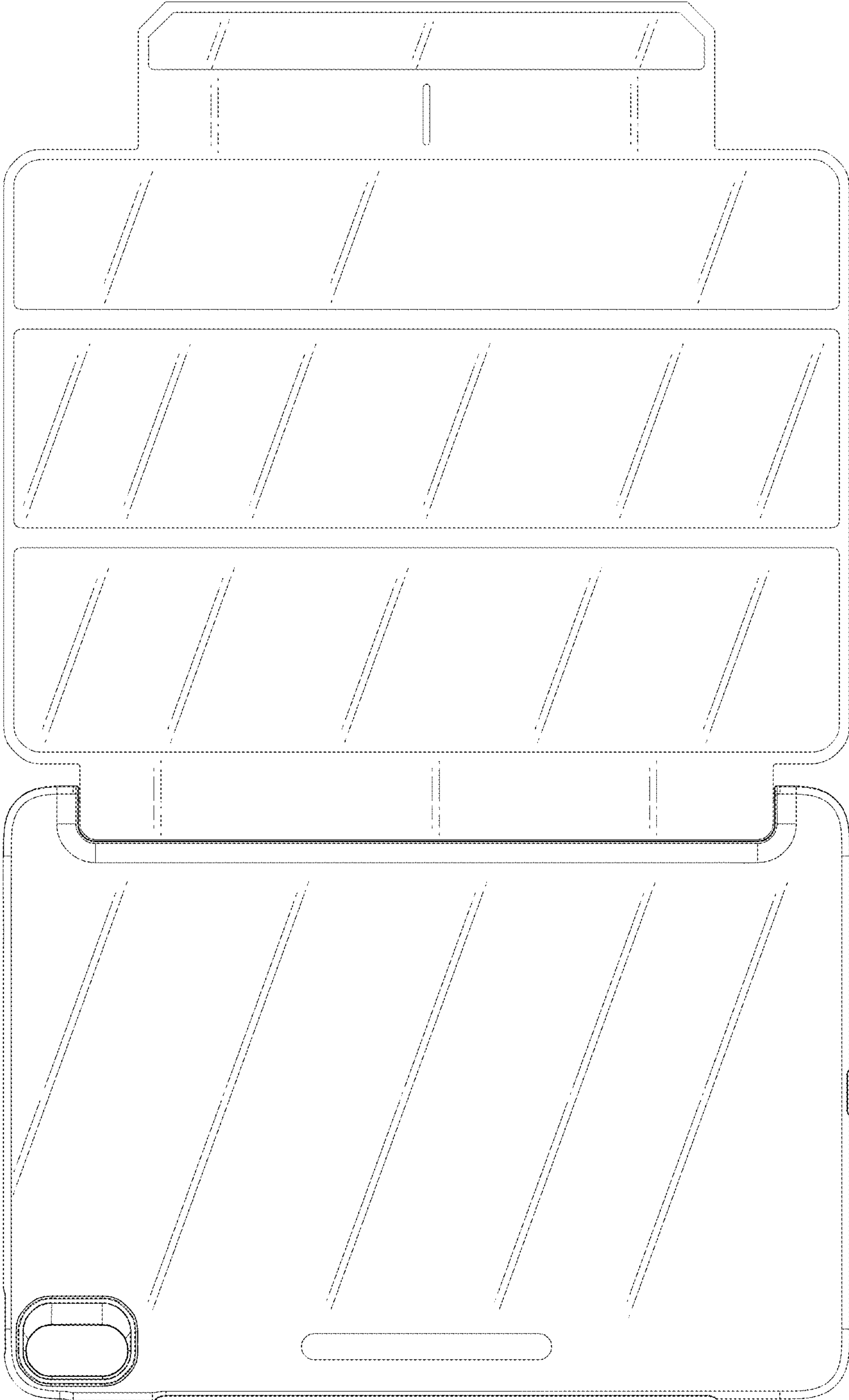

FIG. 1

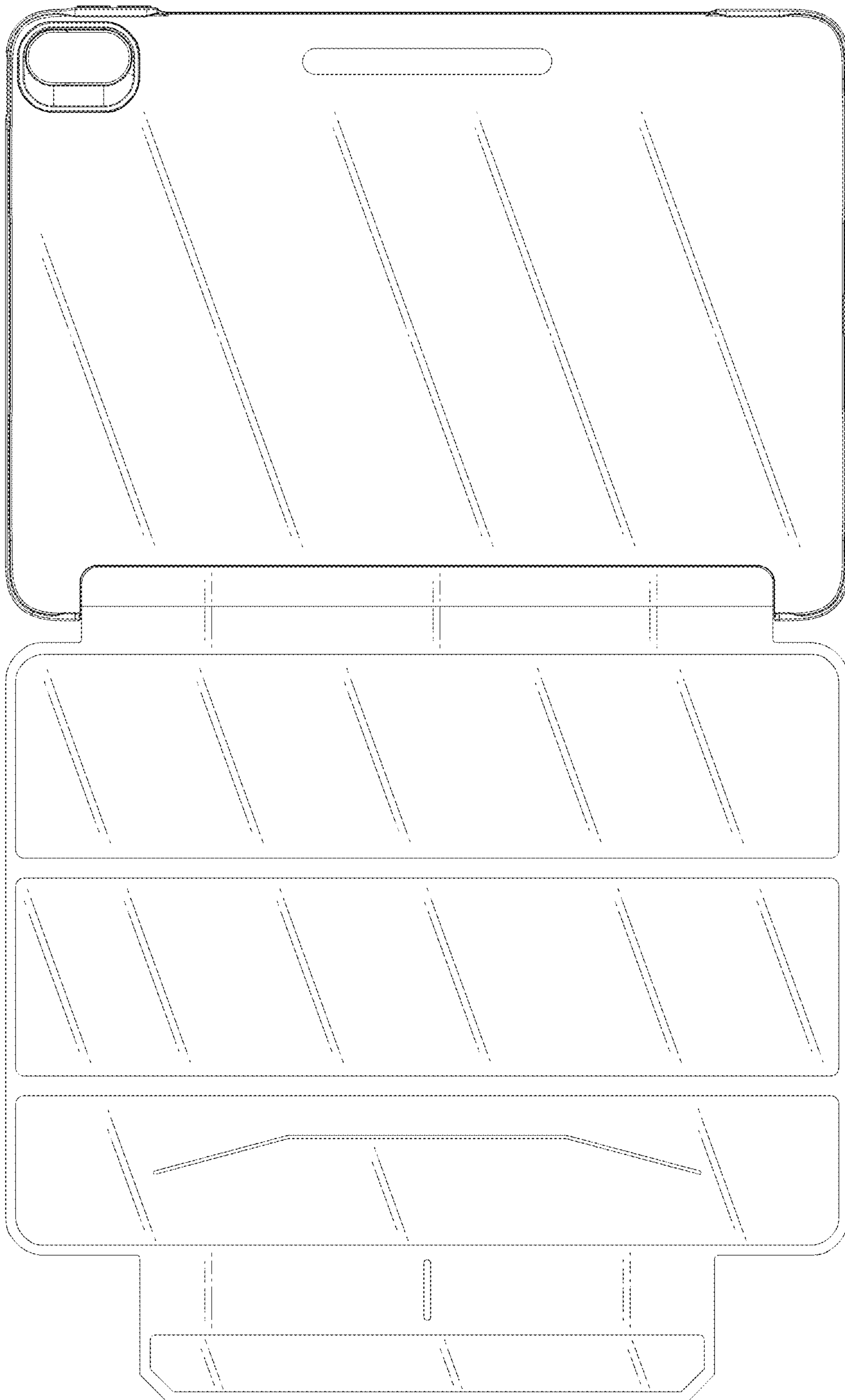

FIG. 2

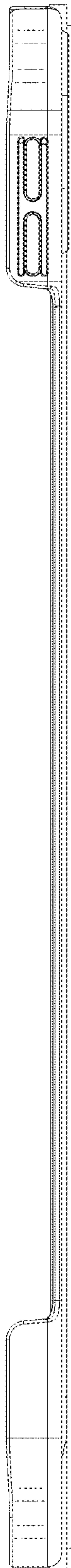

FIG. 3

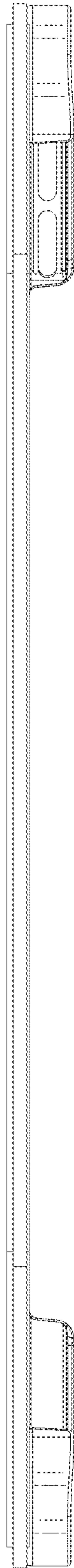

FIG. 4

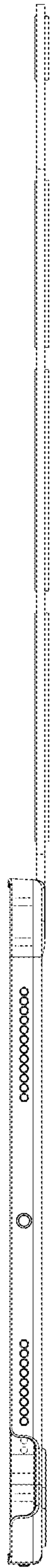

FIG. 5

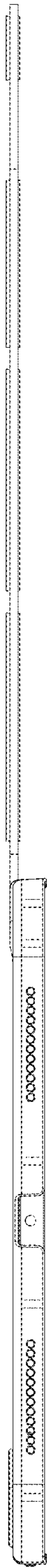

FIG. 6

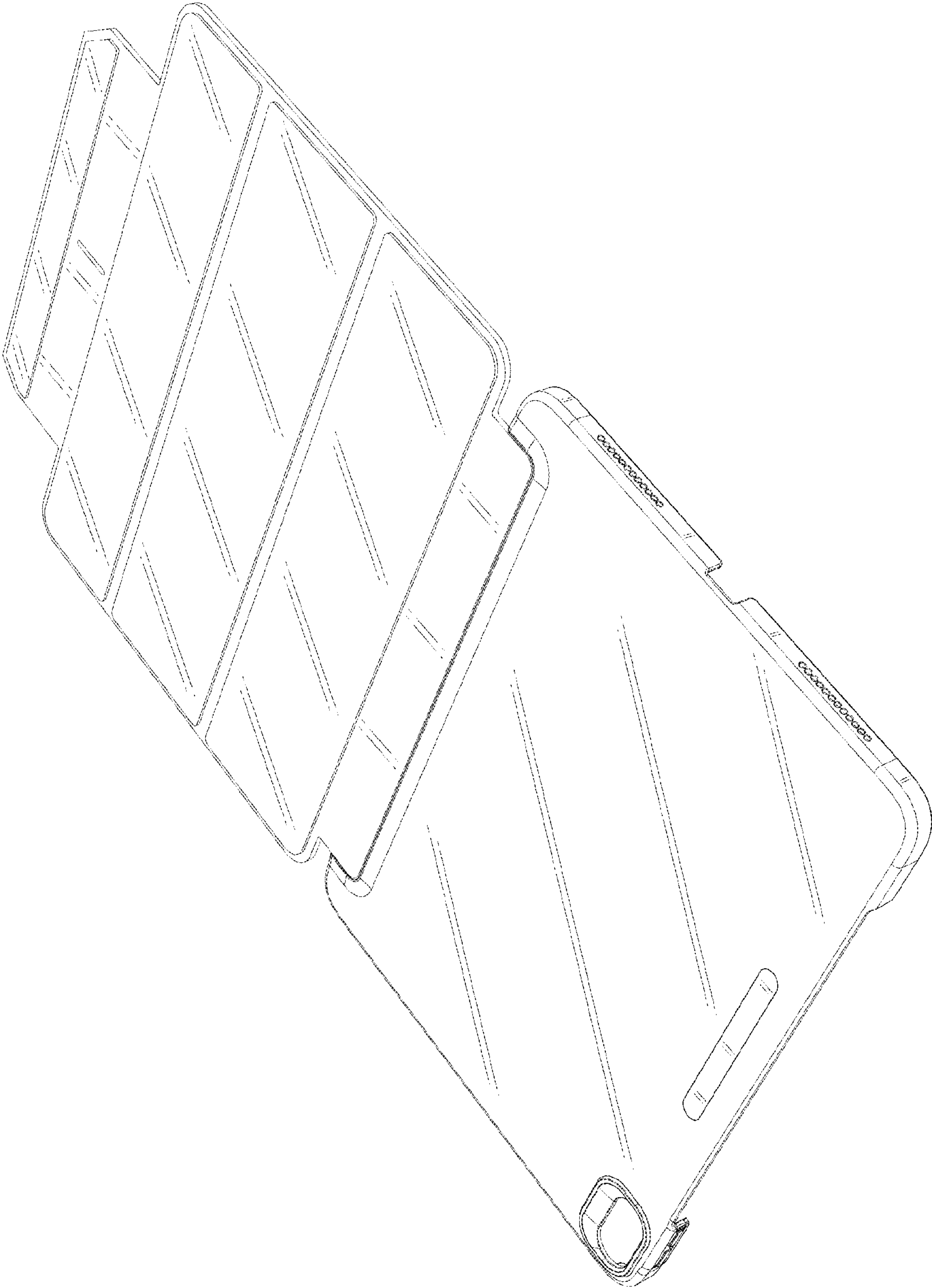

FIG. 7

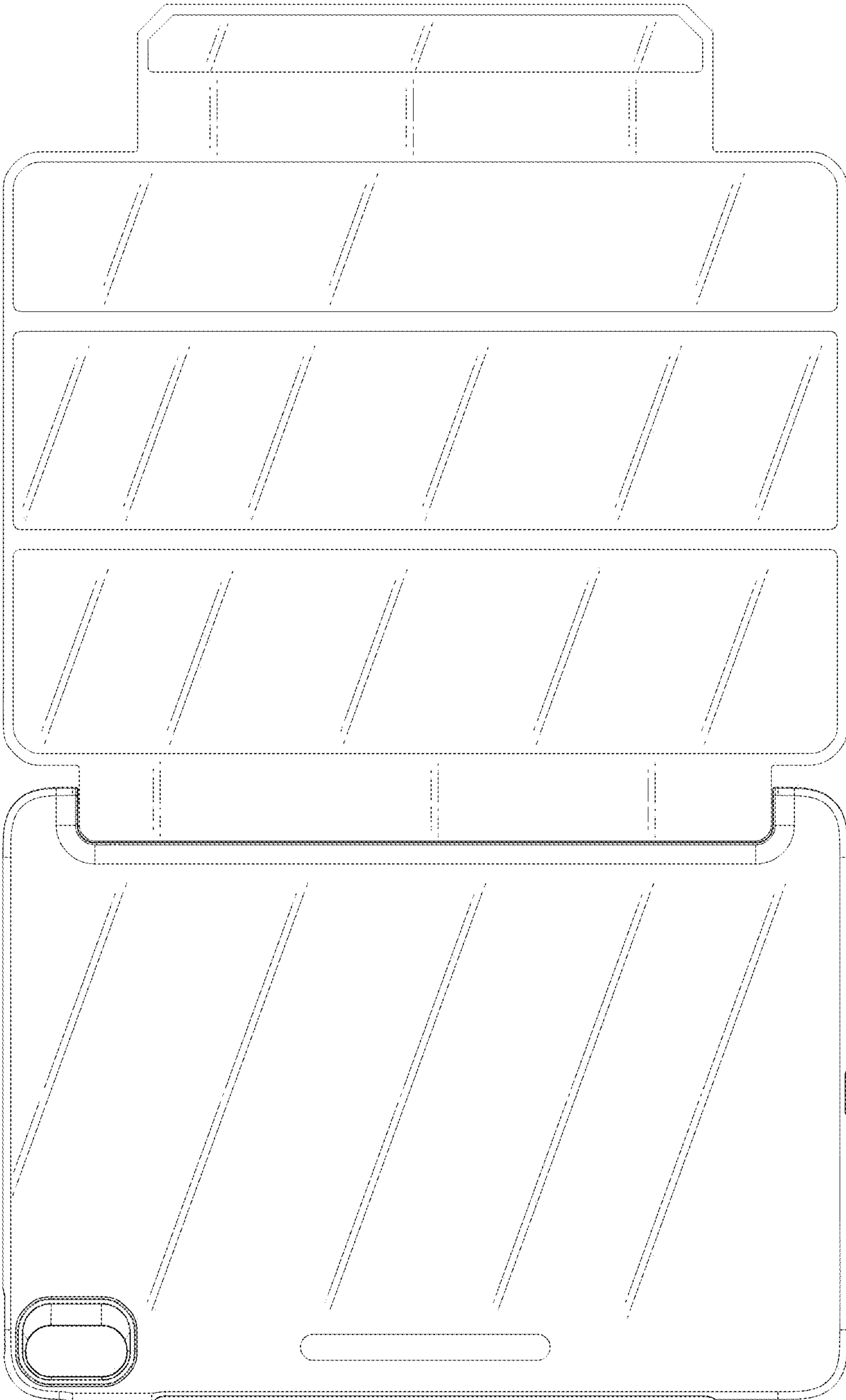

FIG. 8

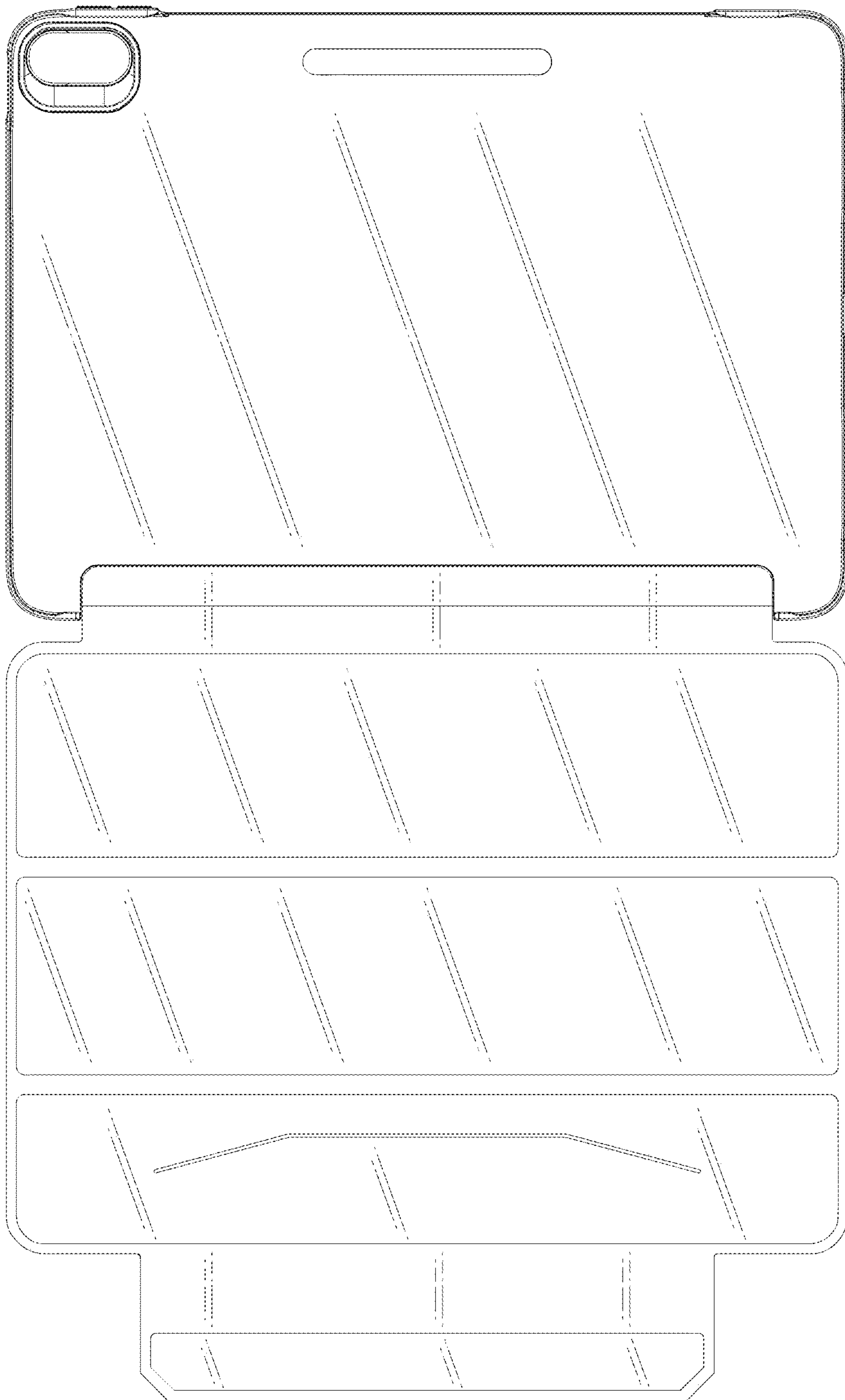

FIG. 9



FIG. 10

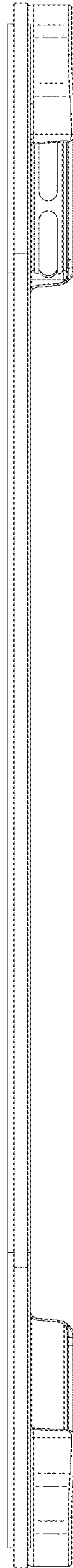

FIG. 11

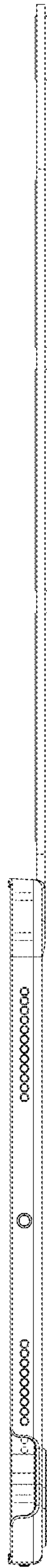

FIG. 12

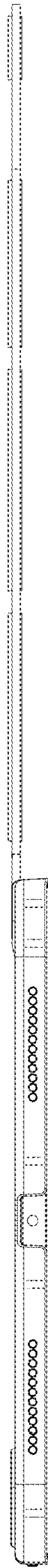

FIG. 13

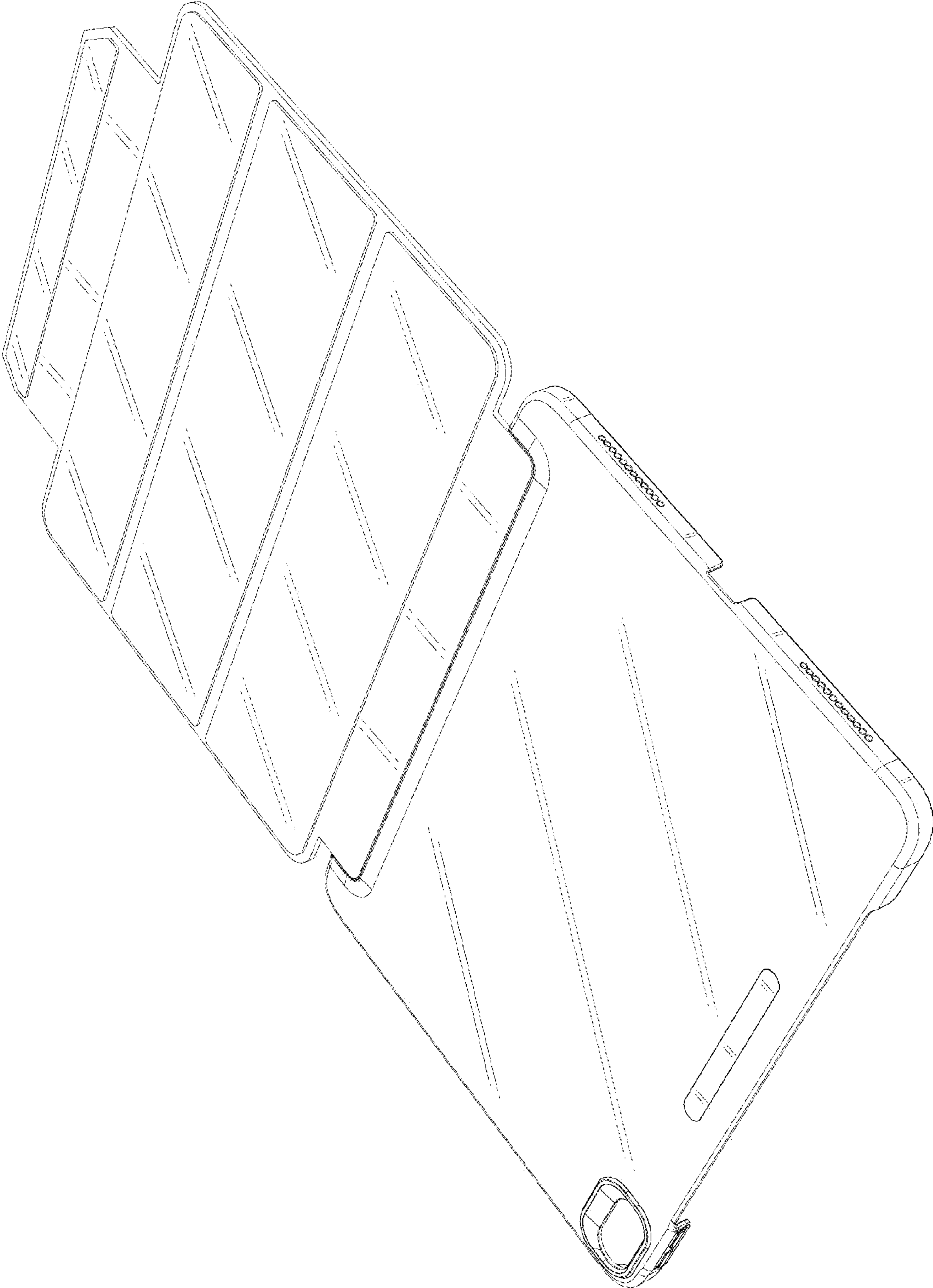

FIG. 14

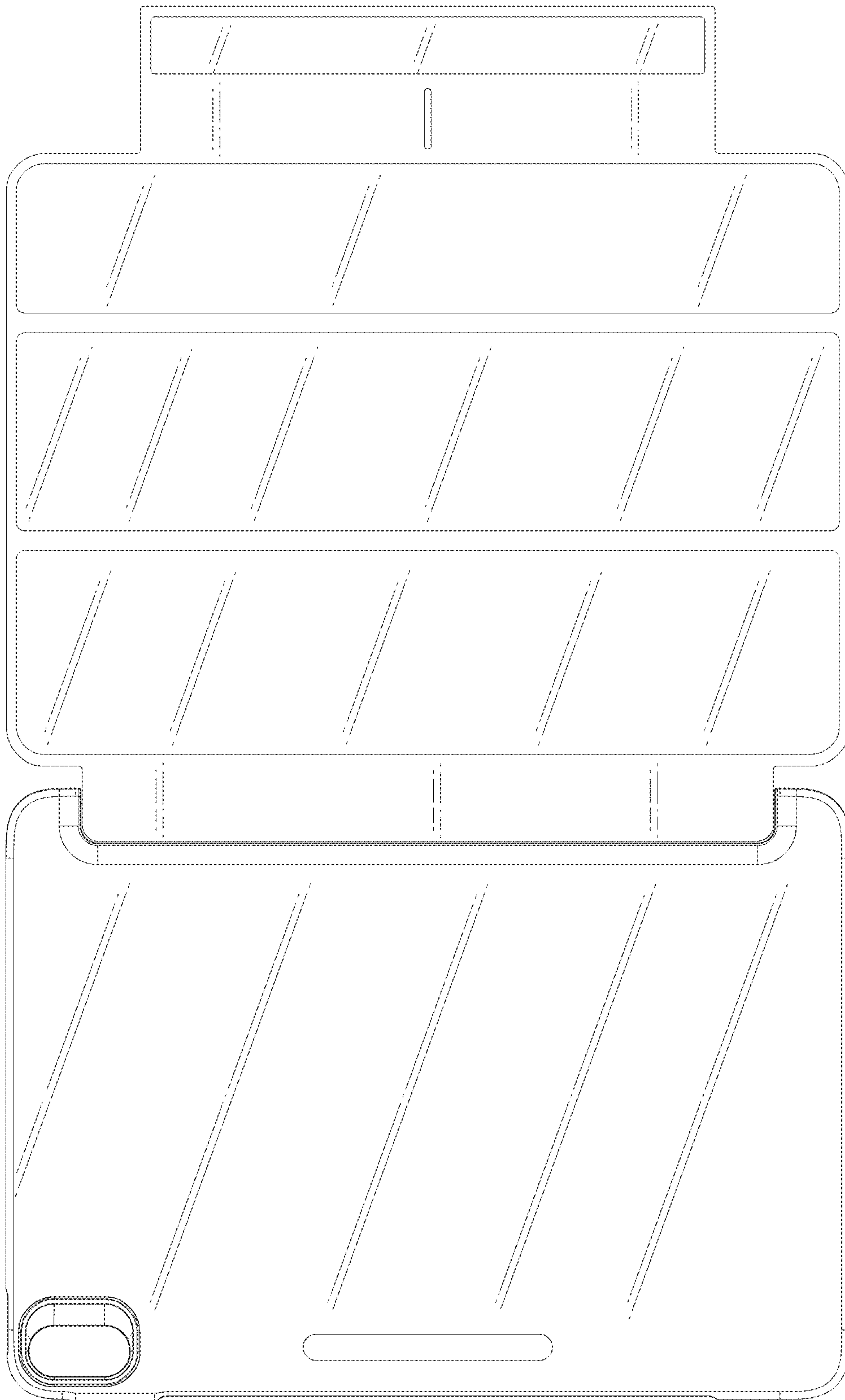

FIG. 15

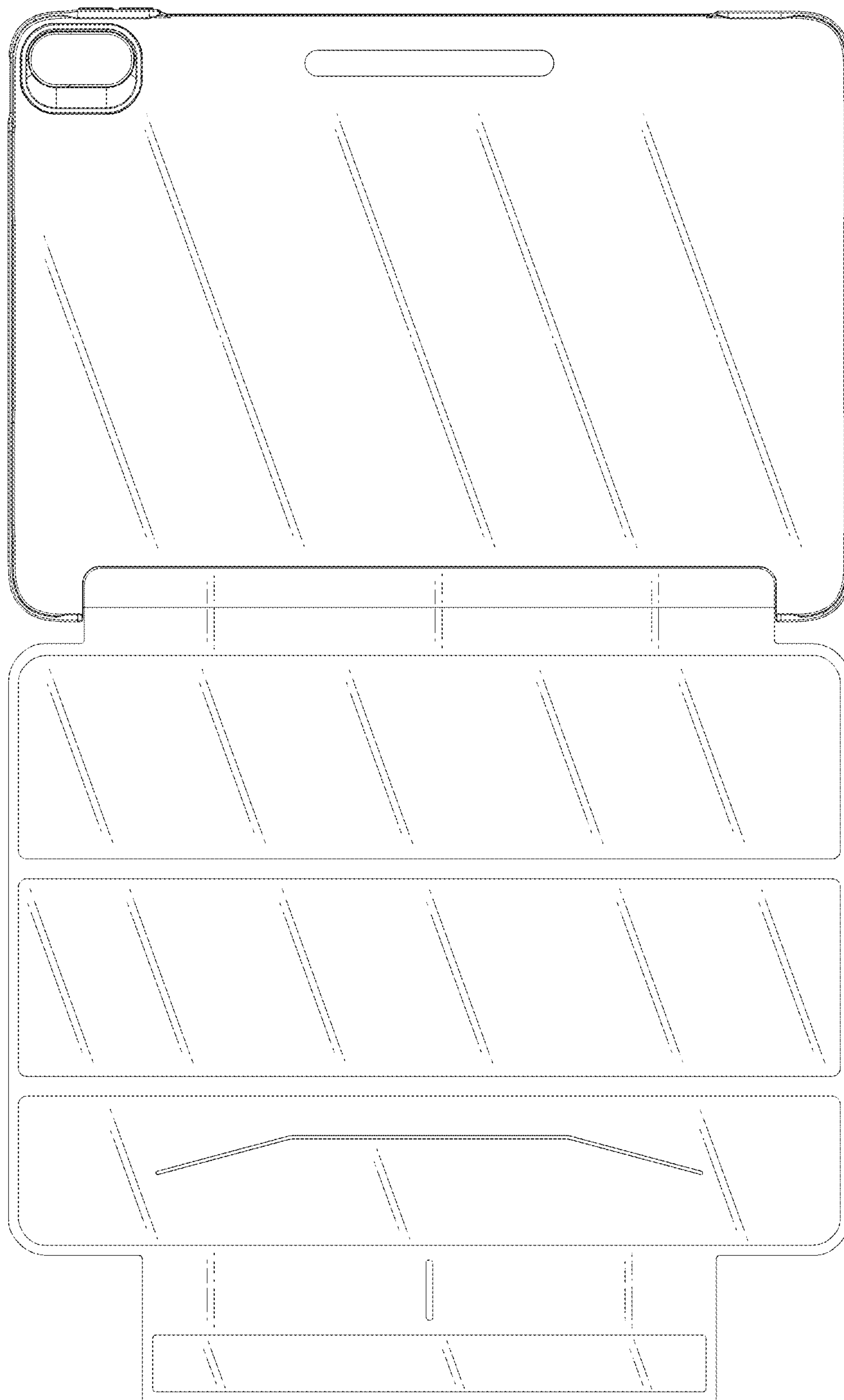

FIG. 16

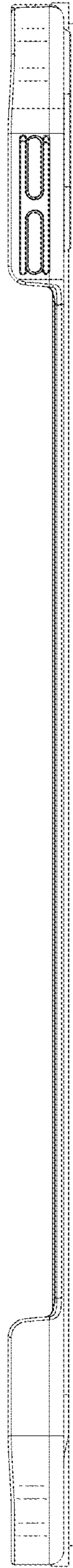

FIG. 17

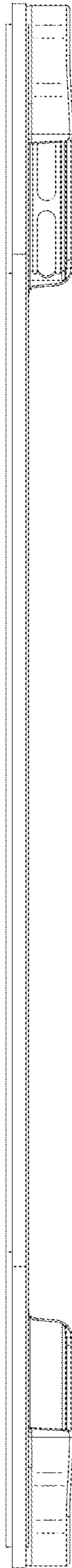

FIG. 18

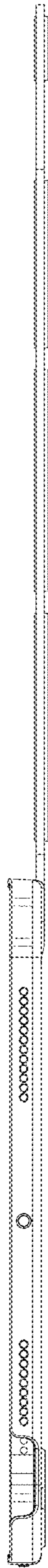

FIG. 19

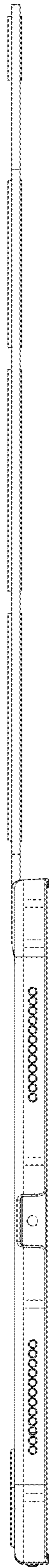

FIG. 20

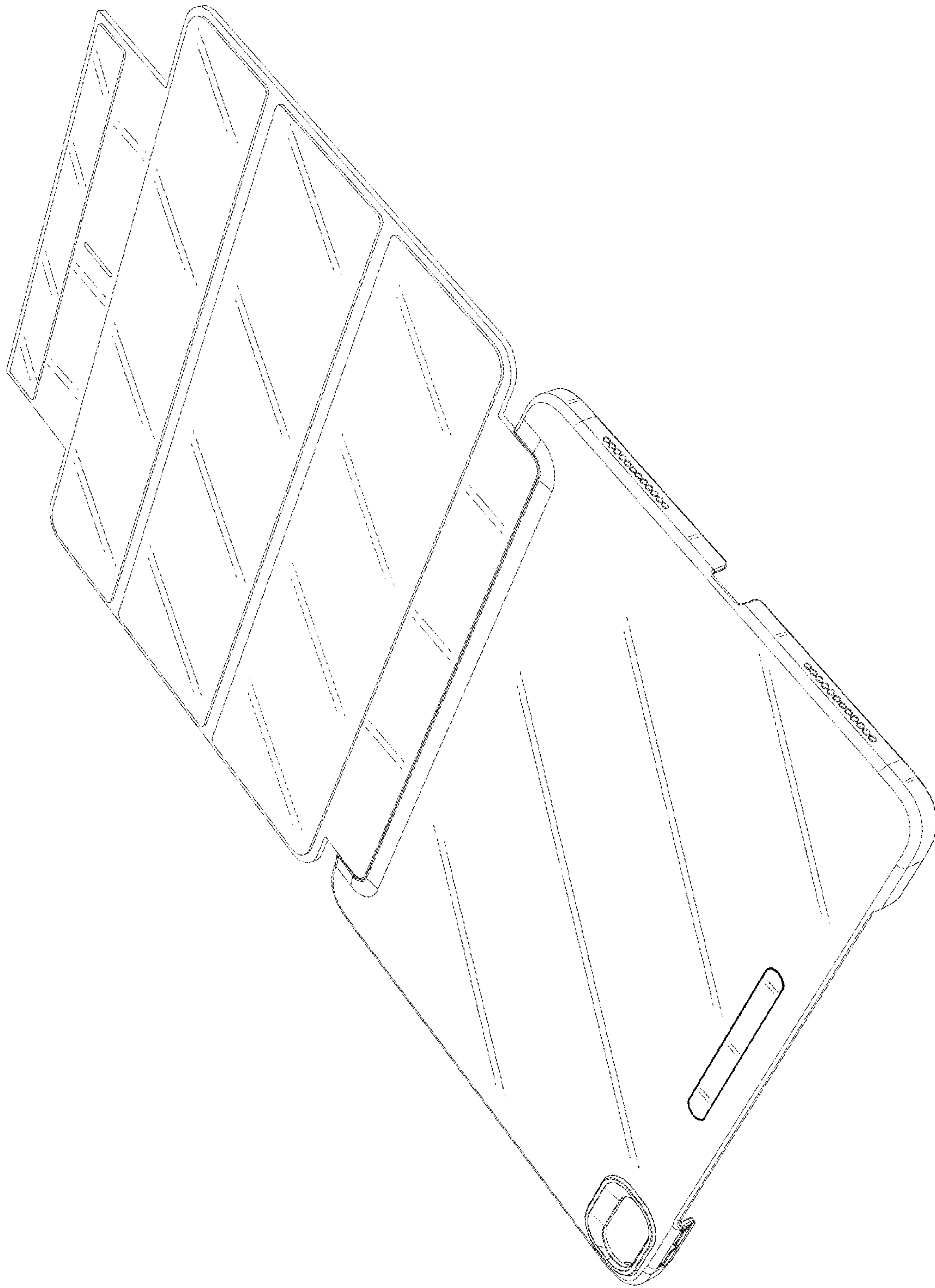

FIG. 21

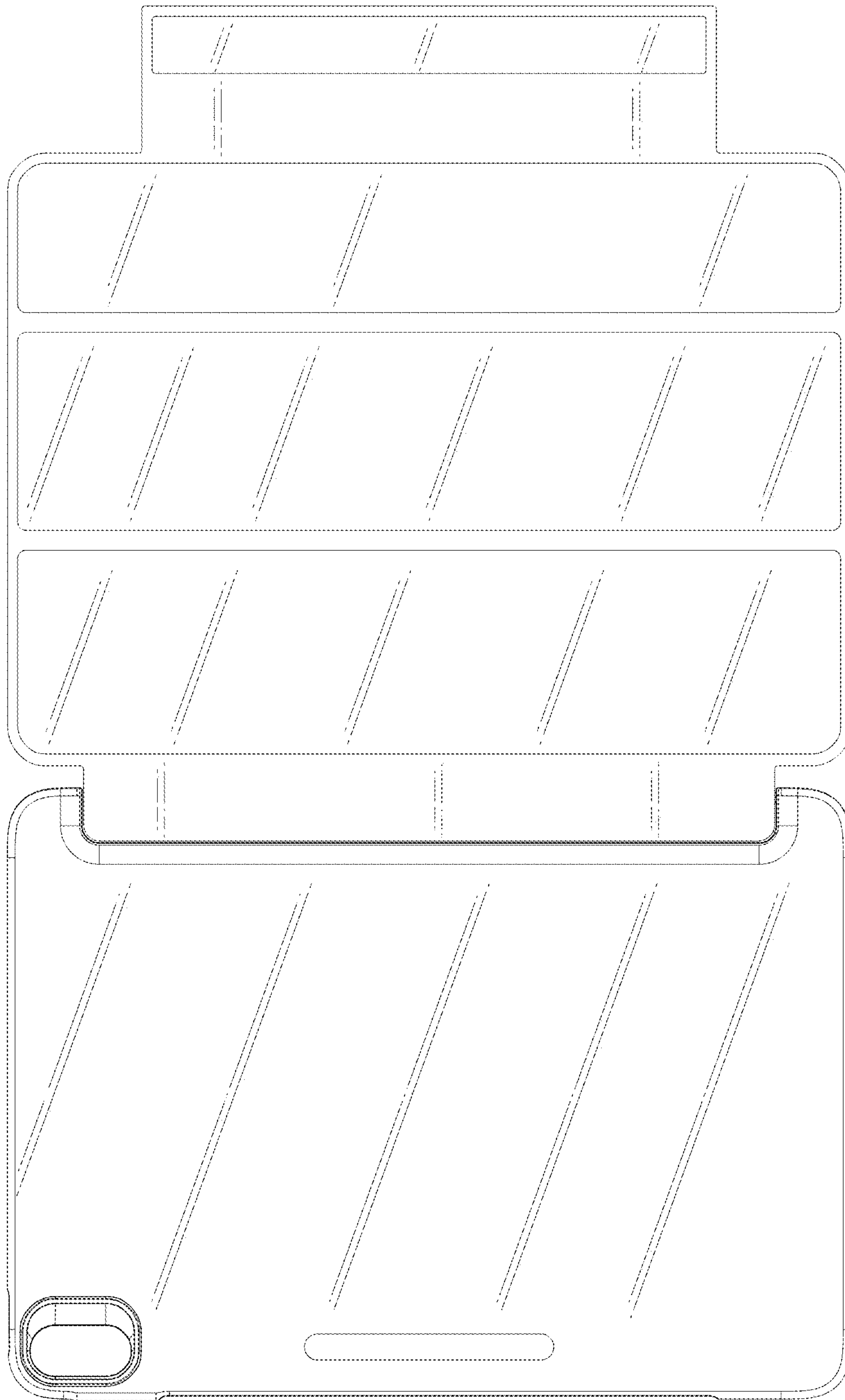

FIG. 22

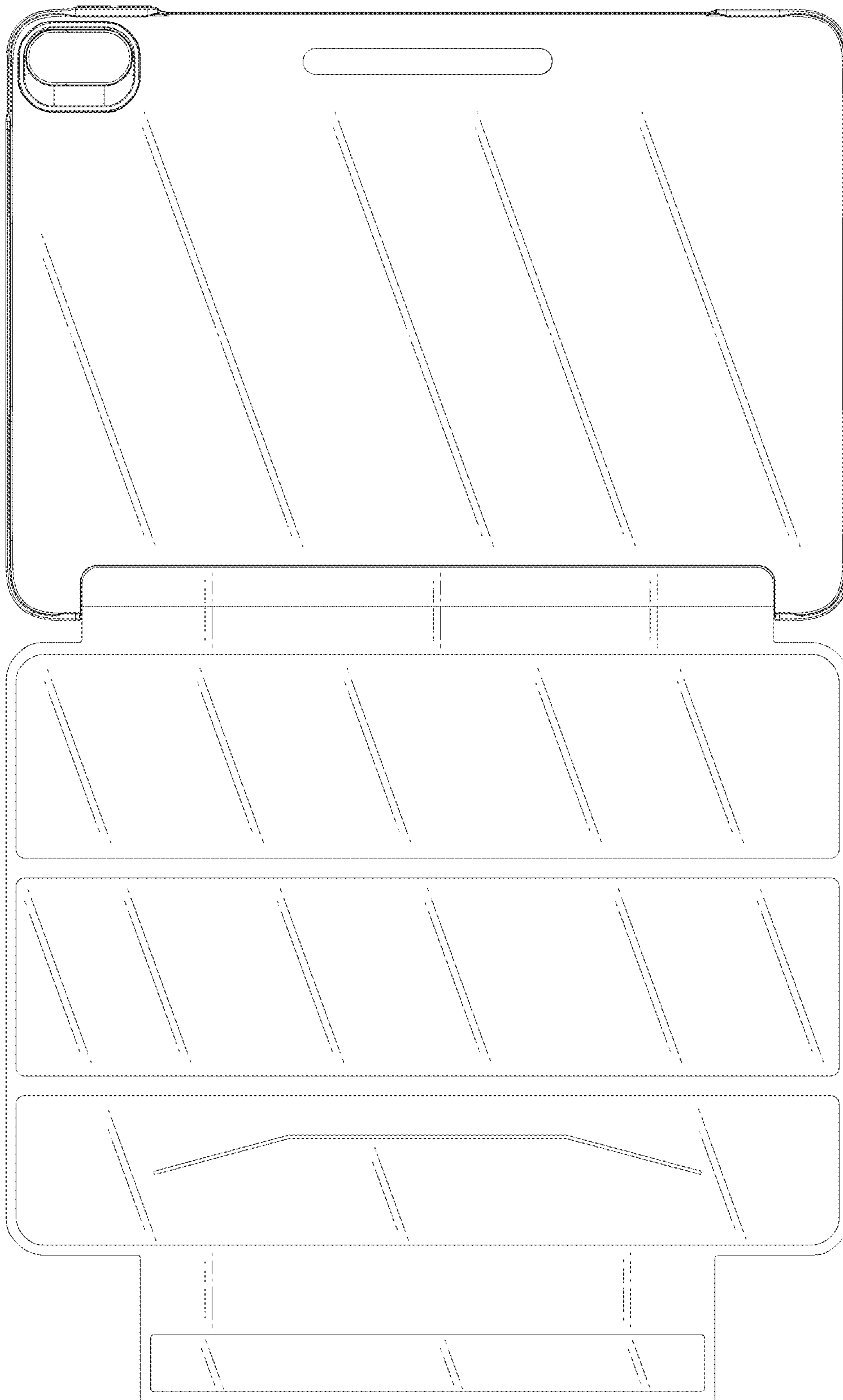

FIG. 23

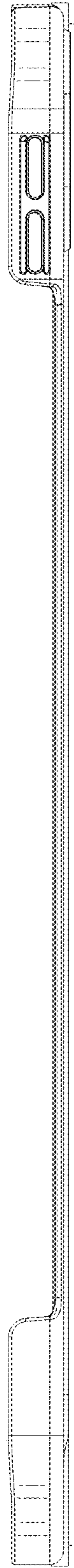

FIG. 24

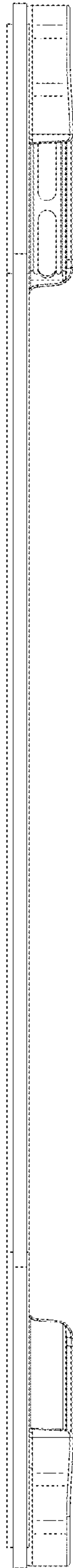

FIG. 25



FIG. 26

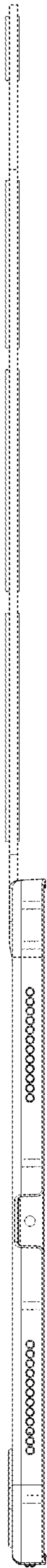

FIG. 27

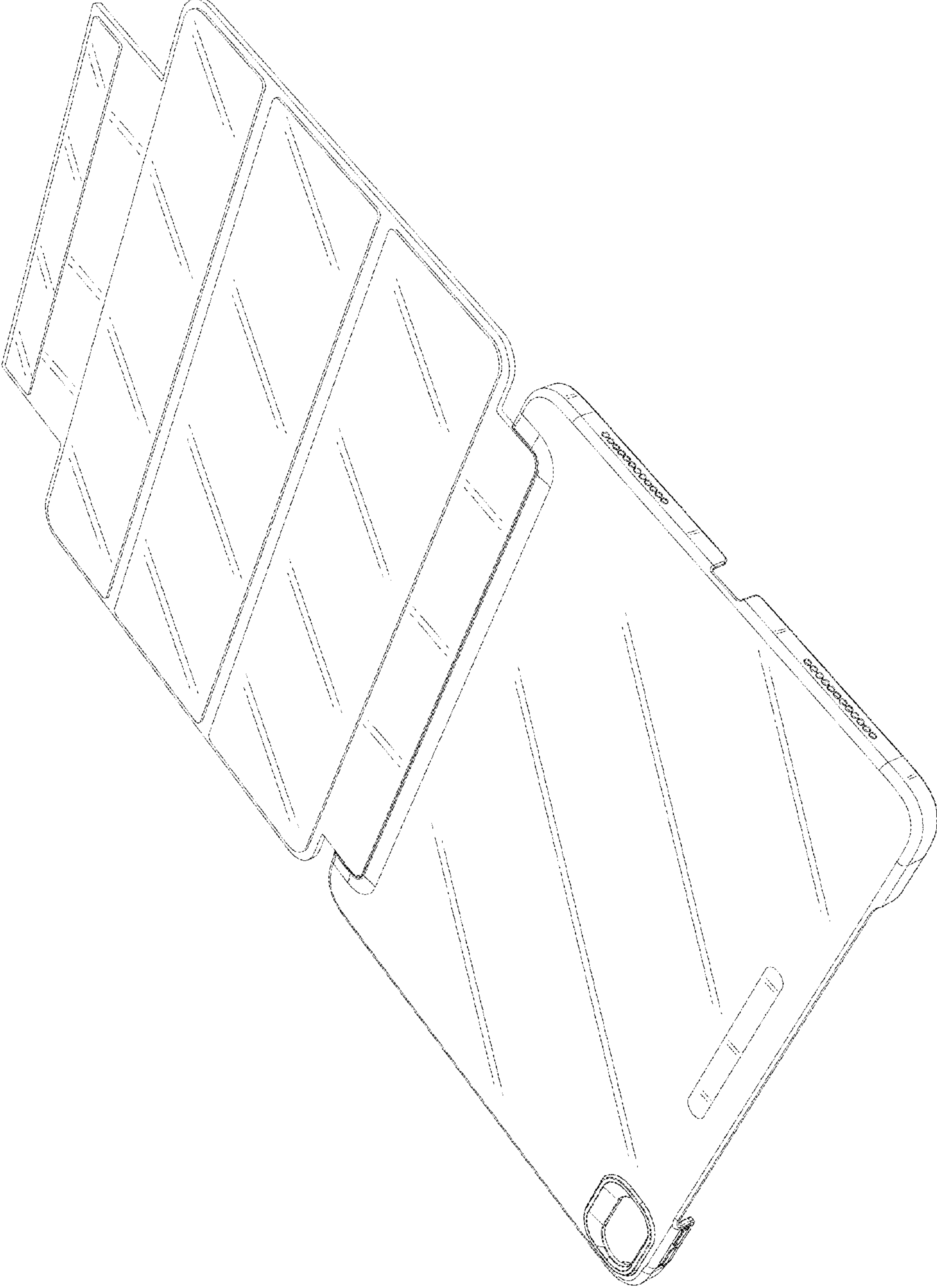

FIG. 28

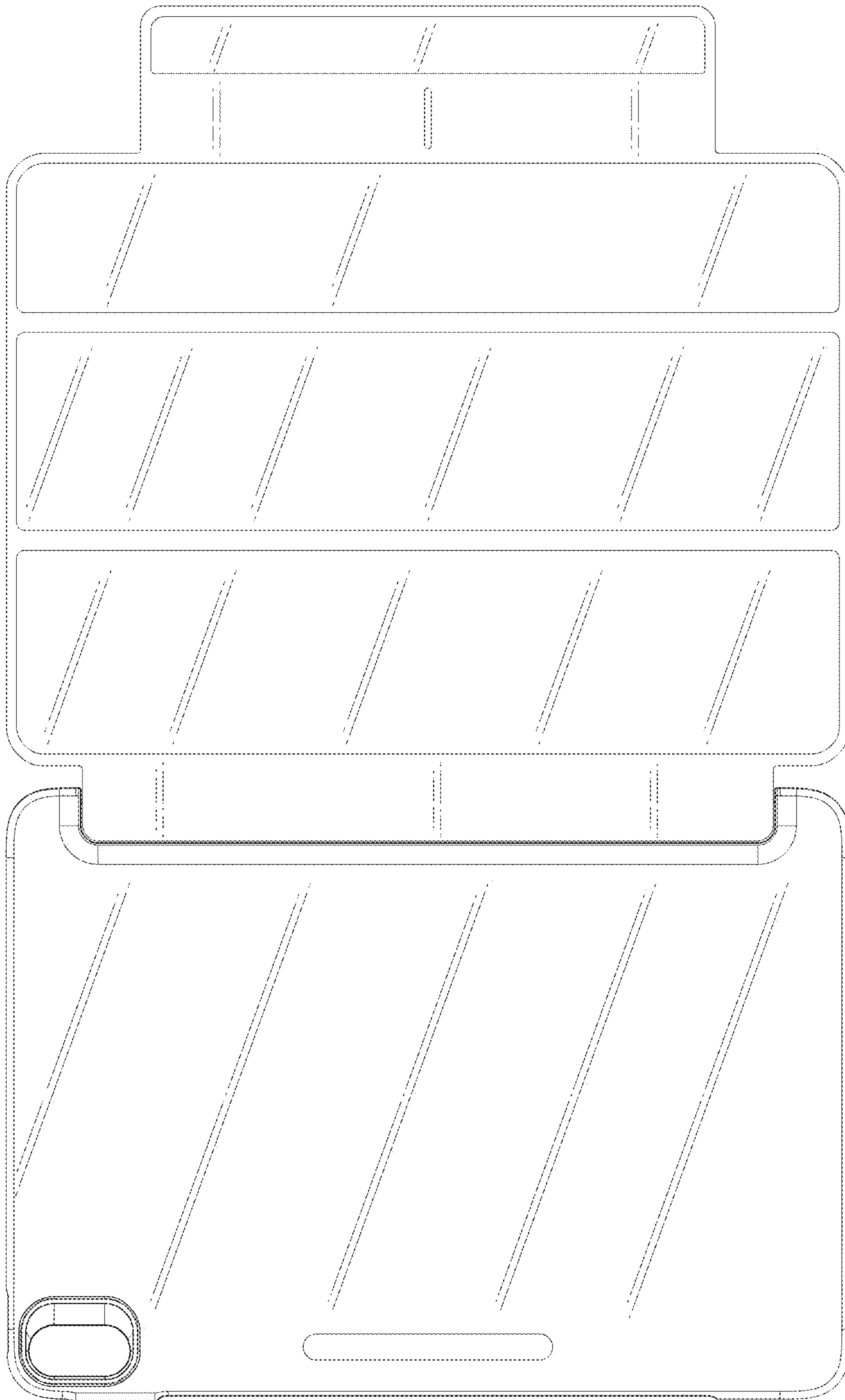

FIG. 29

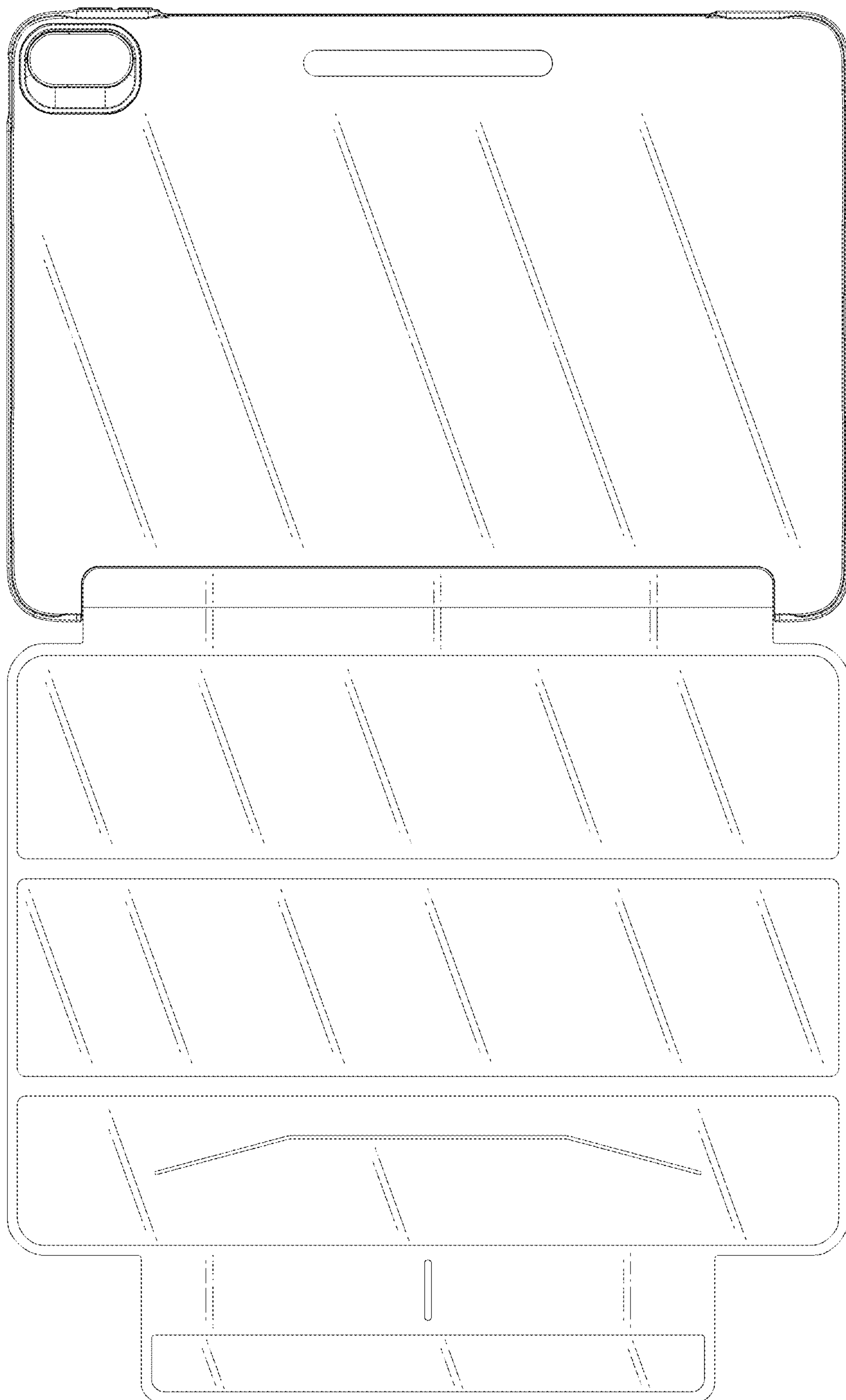

FIG. 30

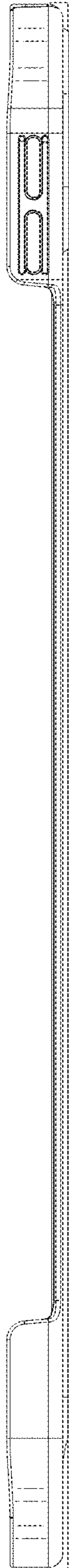

FIG. 31

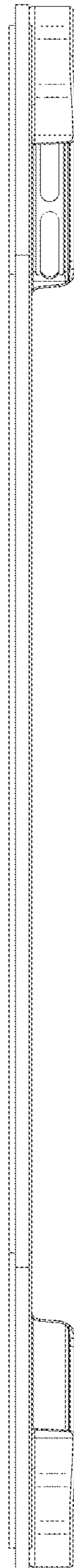

FIG. 32

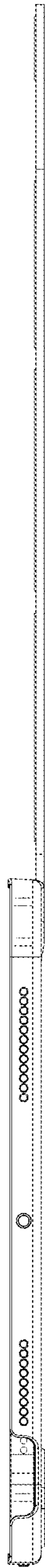

FIG. 33

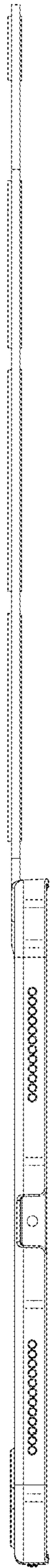

FIG. 34

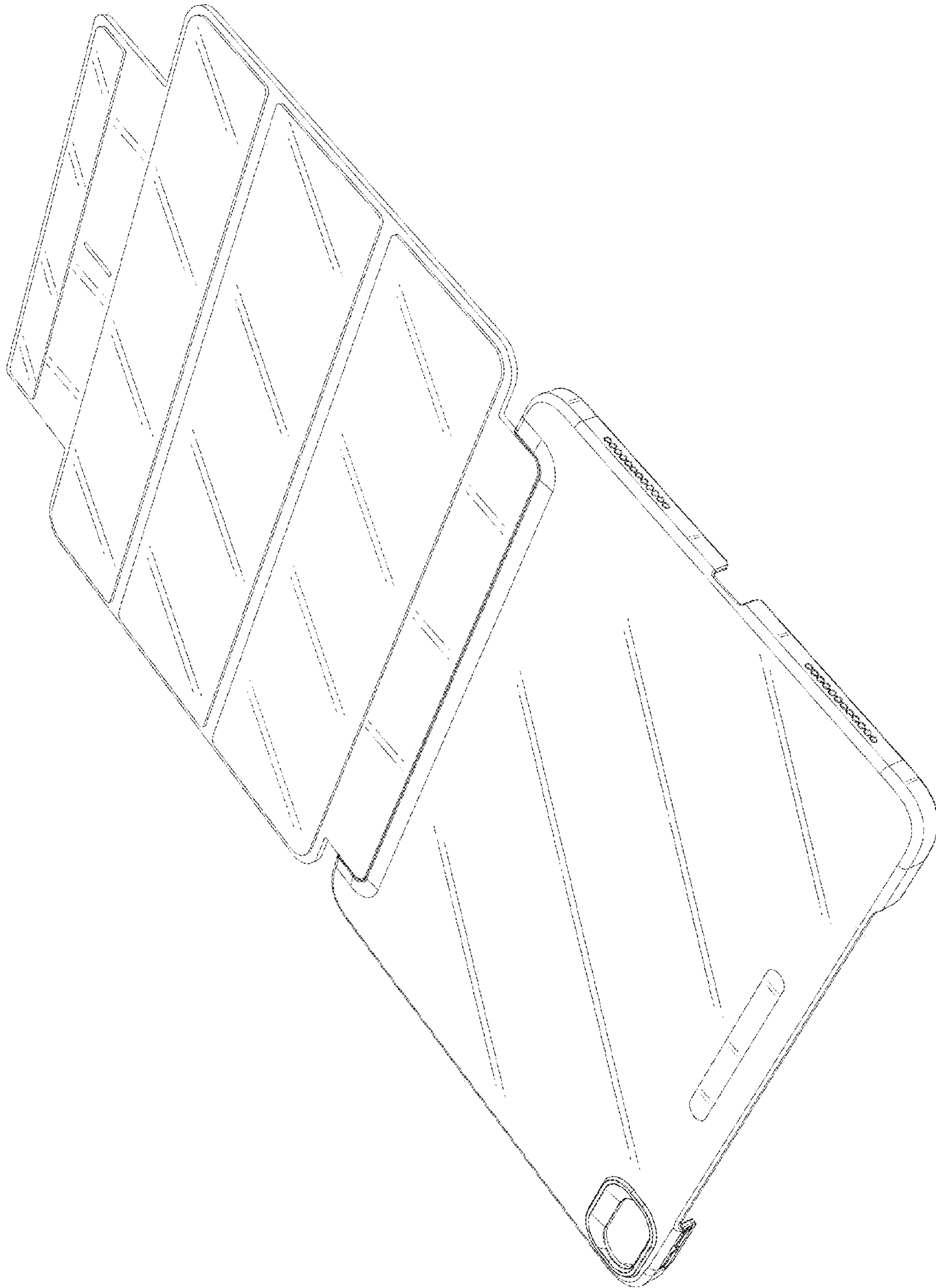

FIG. 35

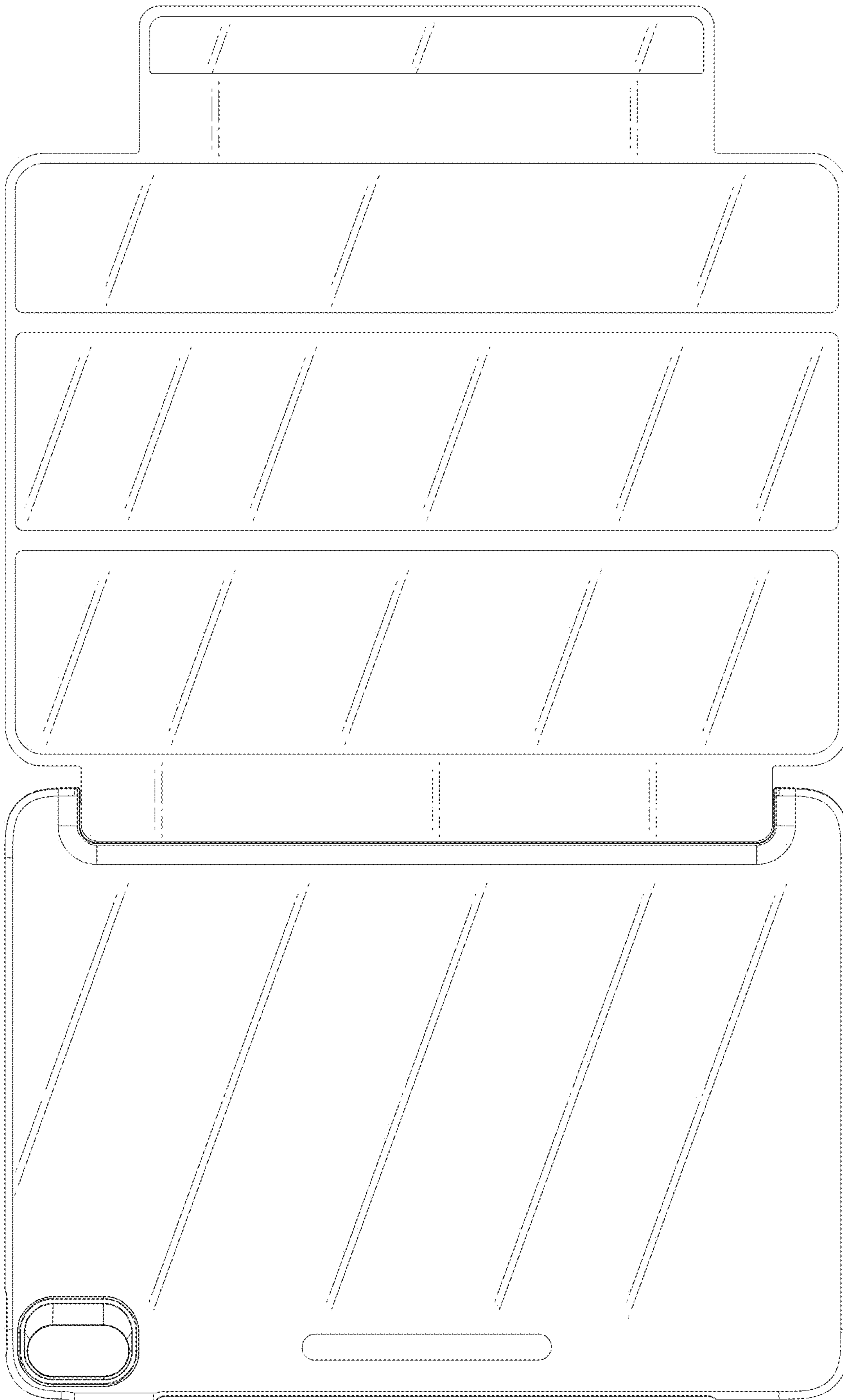

FIG. 36

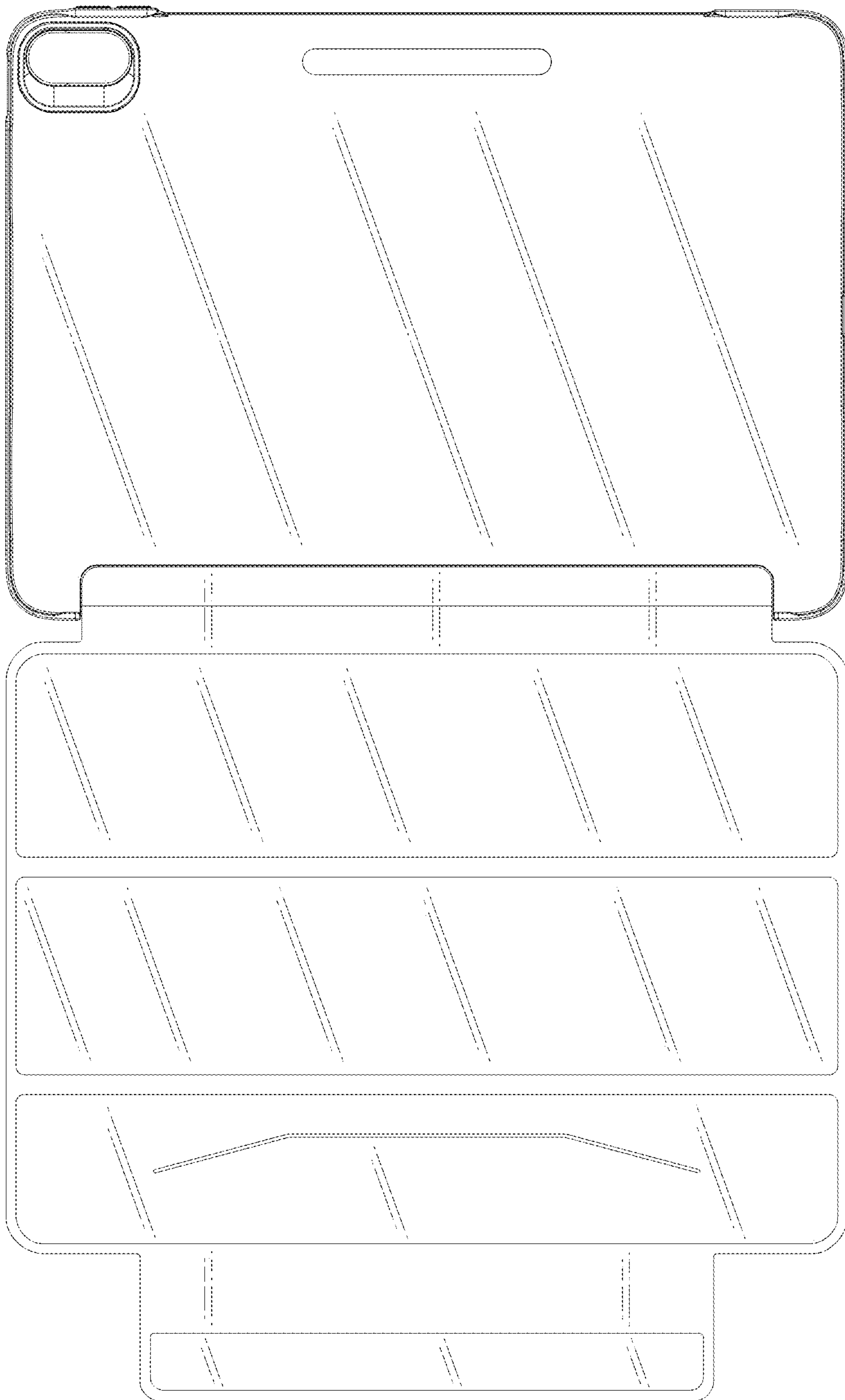

FIG. 37



FIG. 38

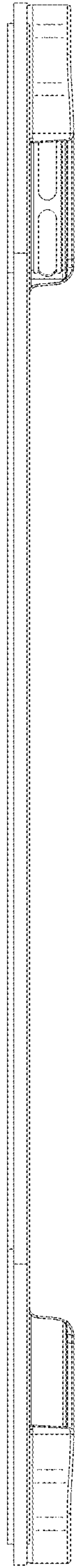

FIG. 39

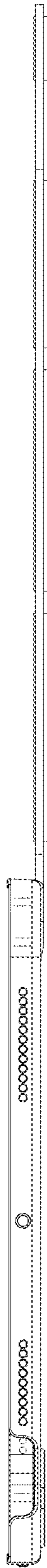

FIG. 40

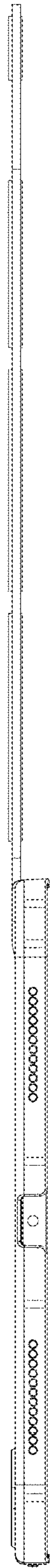

FIG. 41

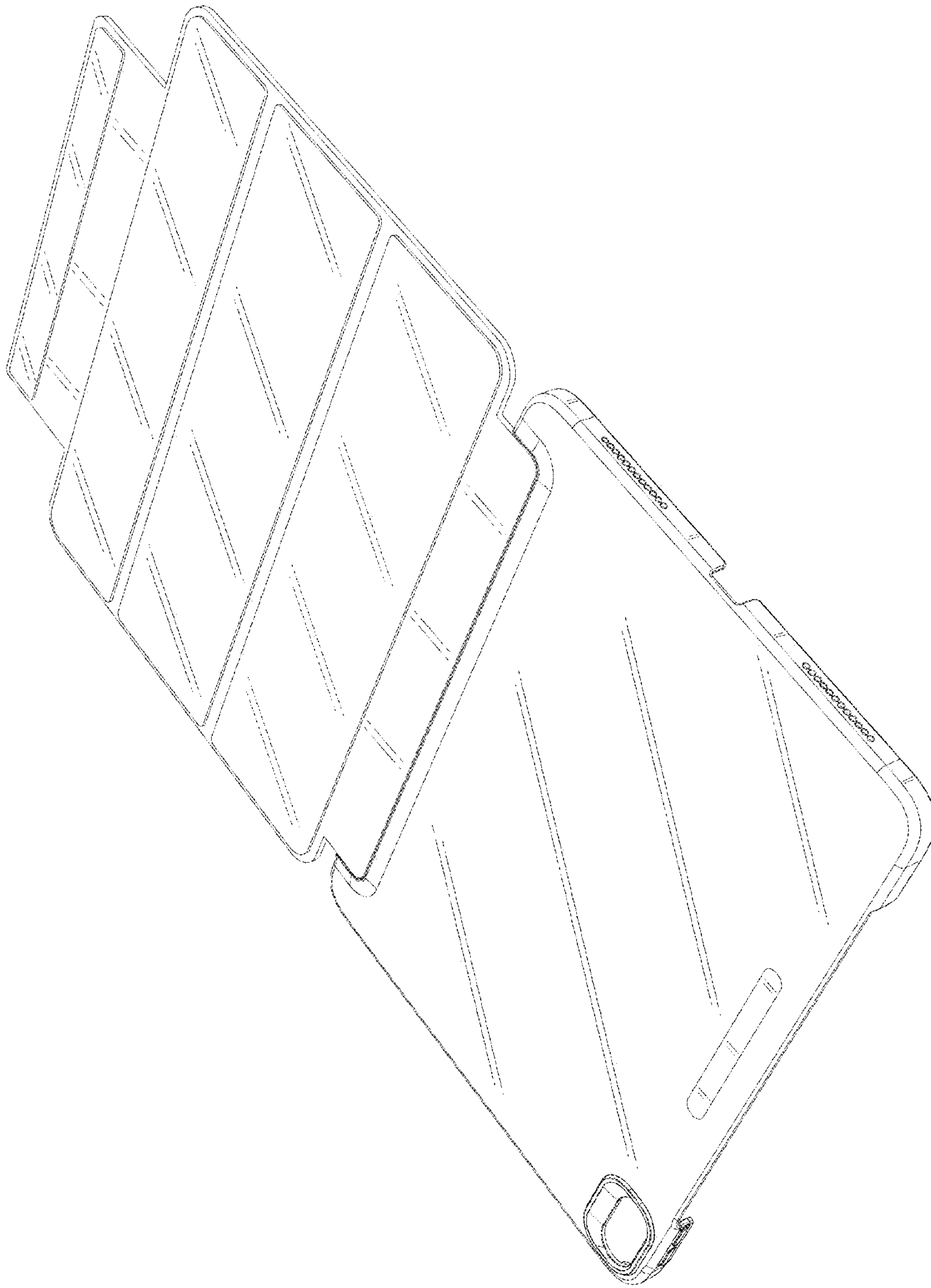

FIG. 42

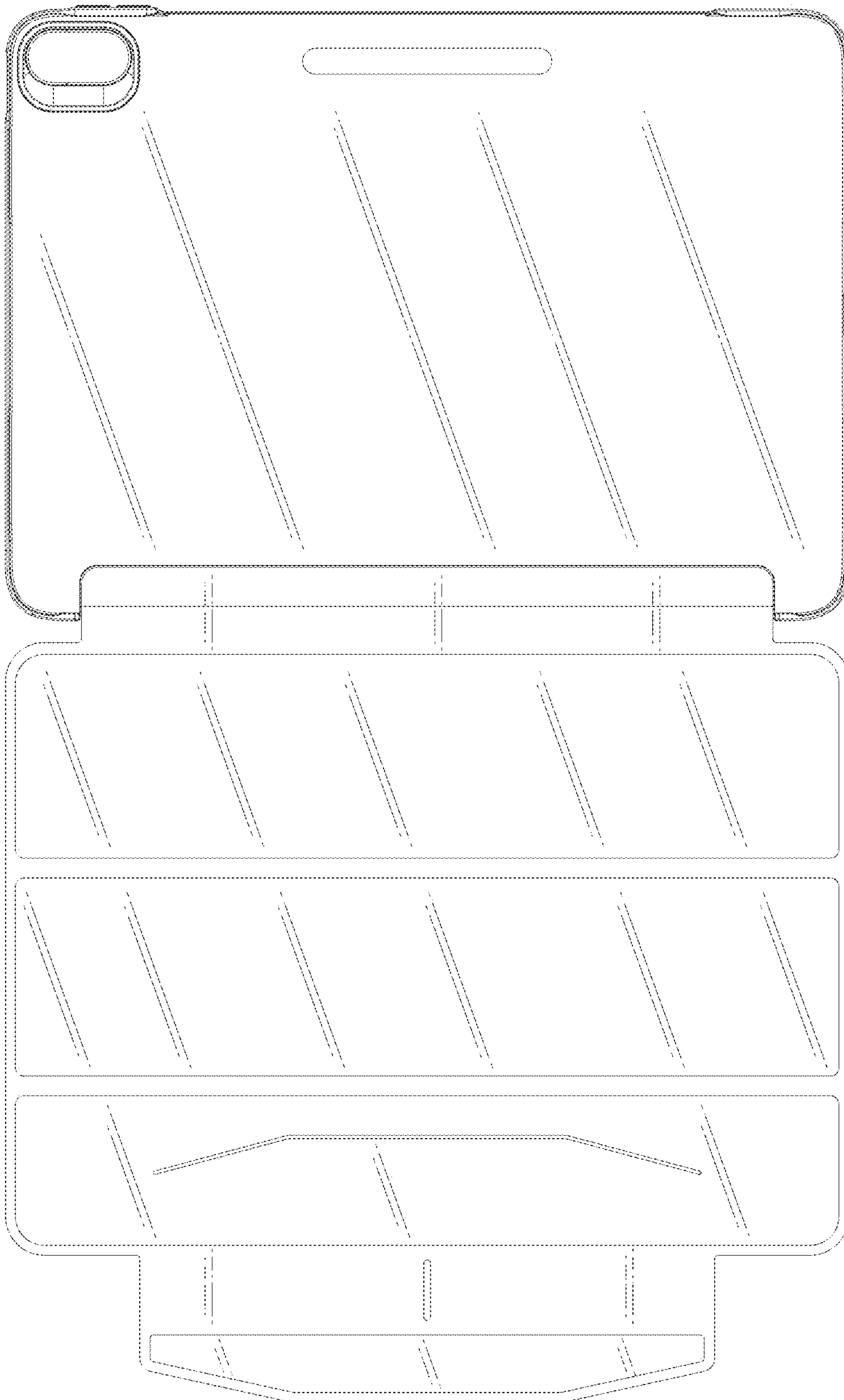

FIG. 43

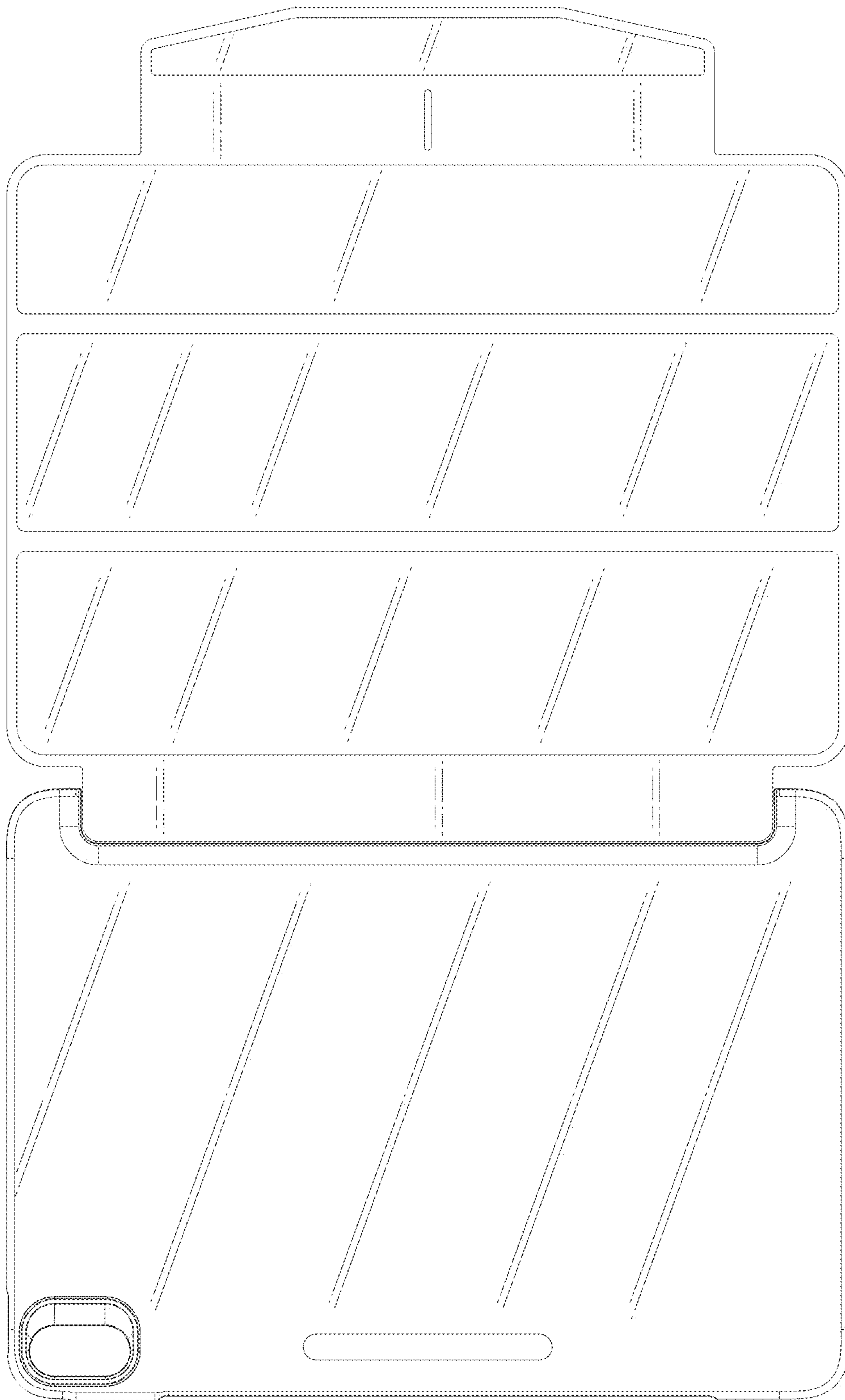

FIG. 44

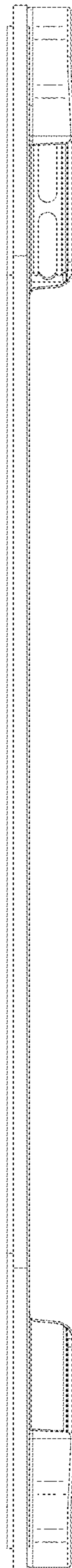

FIG. 45

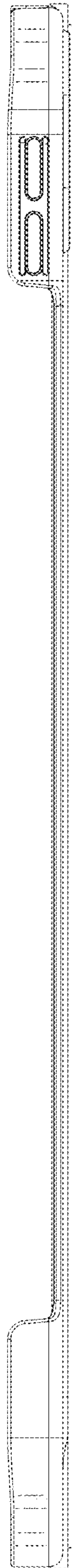

FIG. 46

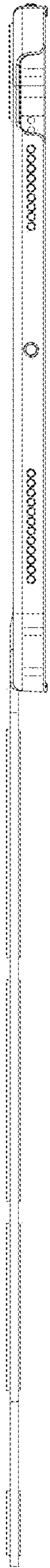

FIG. 47

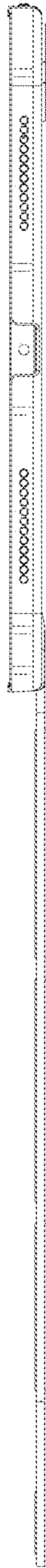

FIG. 48

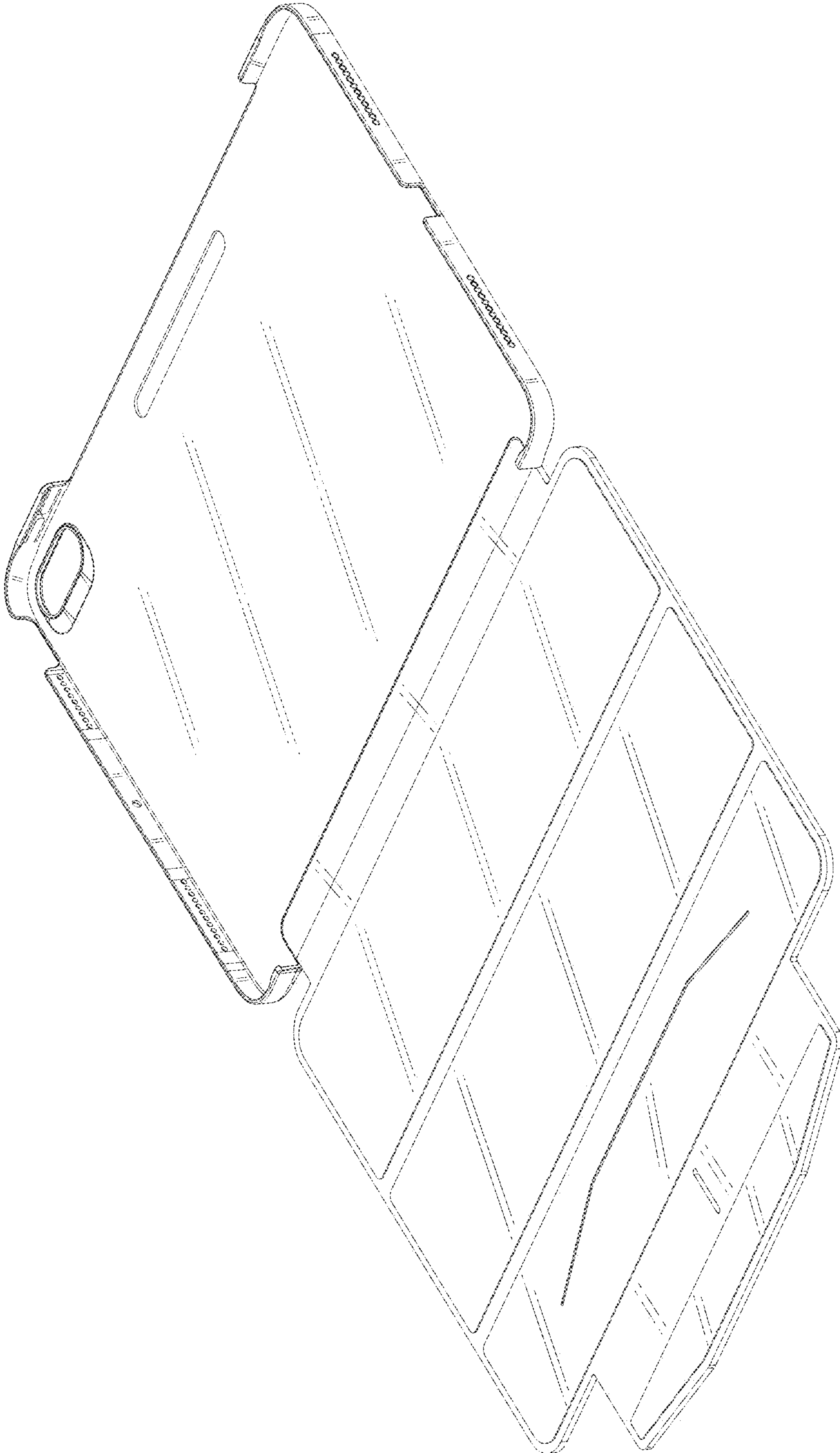

FIG. 49

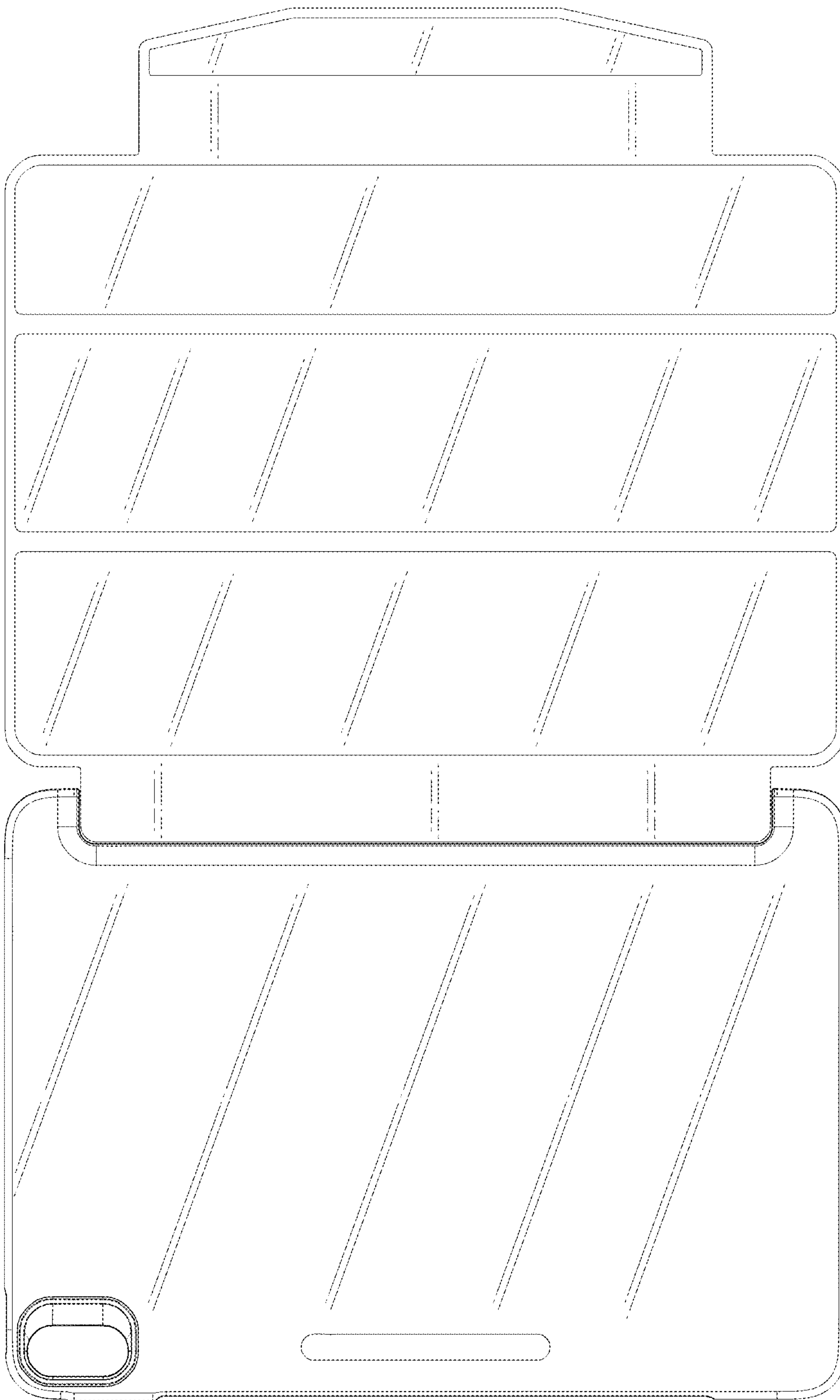

FIG. 50

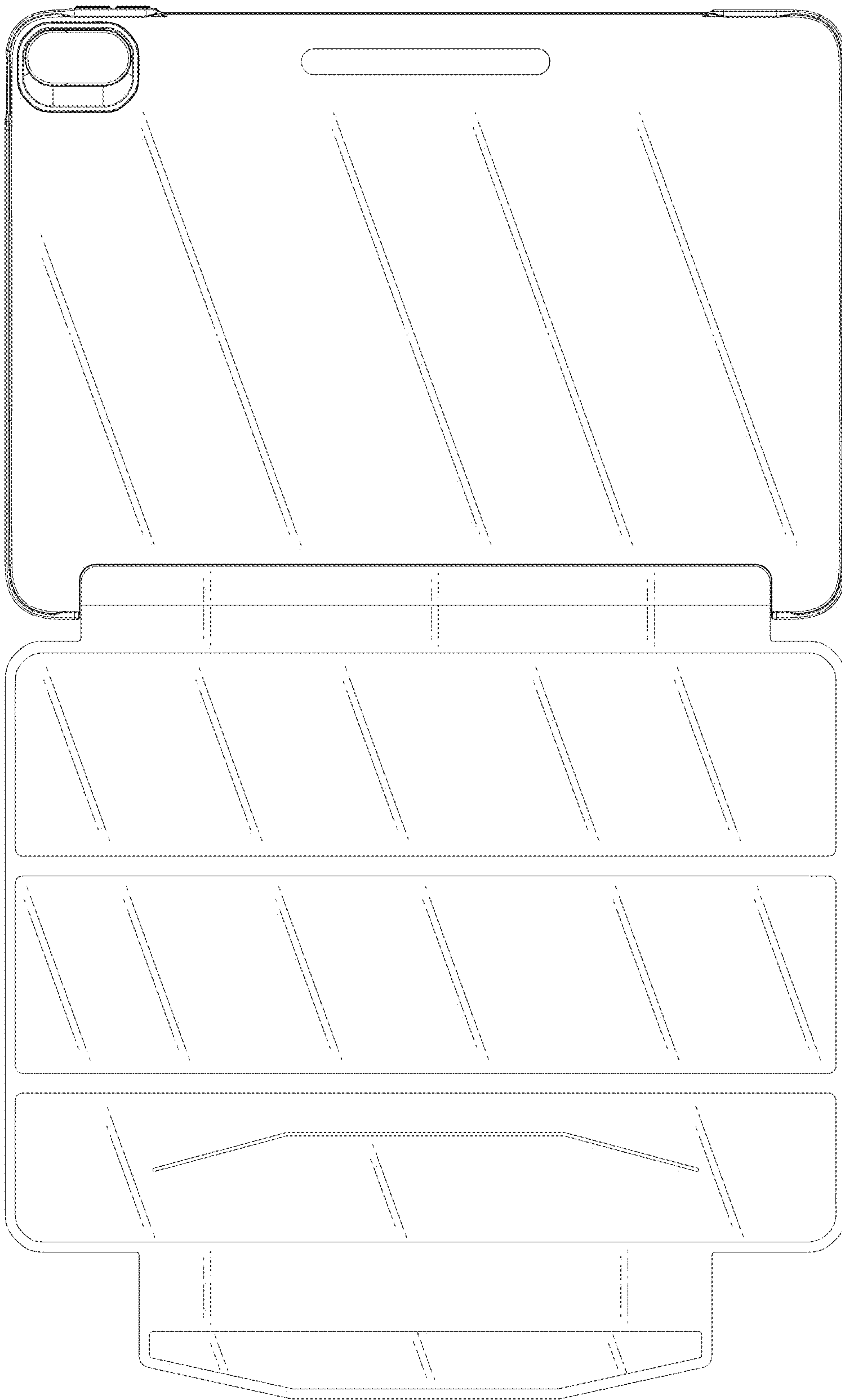

FIG. 51



FIG. 52

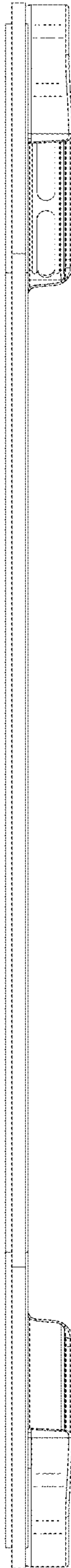

FIG. 53



FIG.54

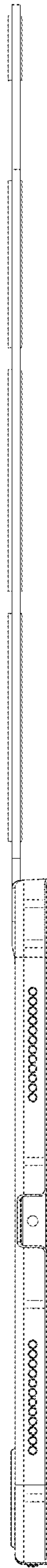

FIG.55

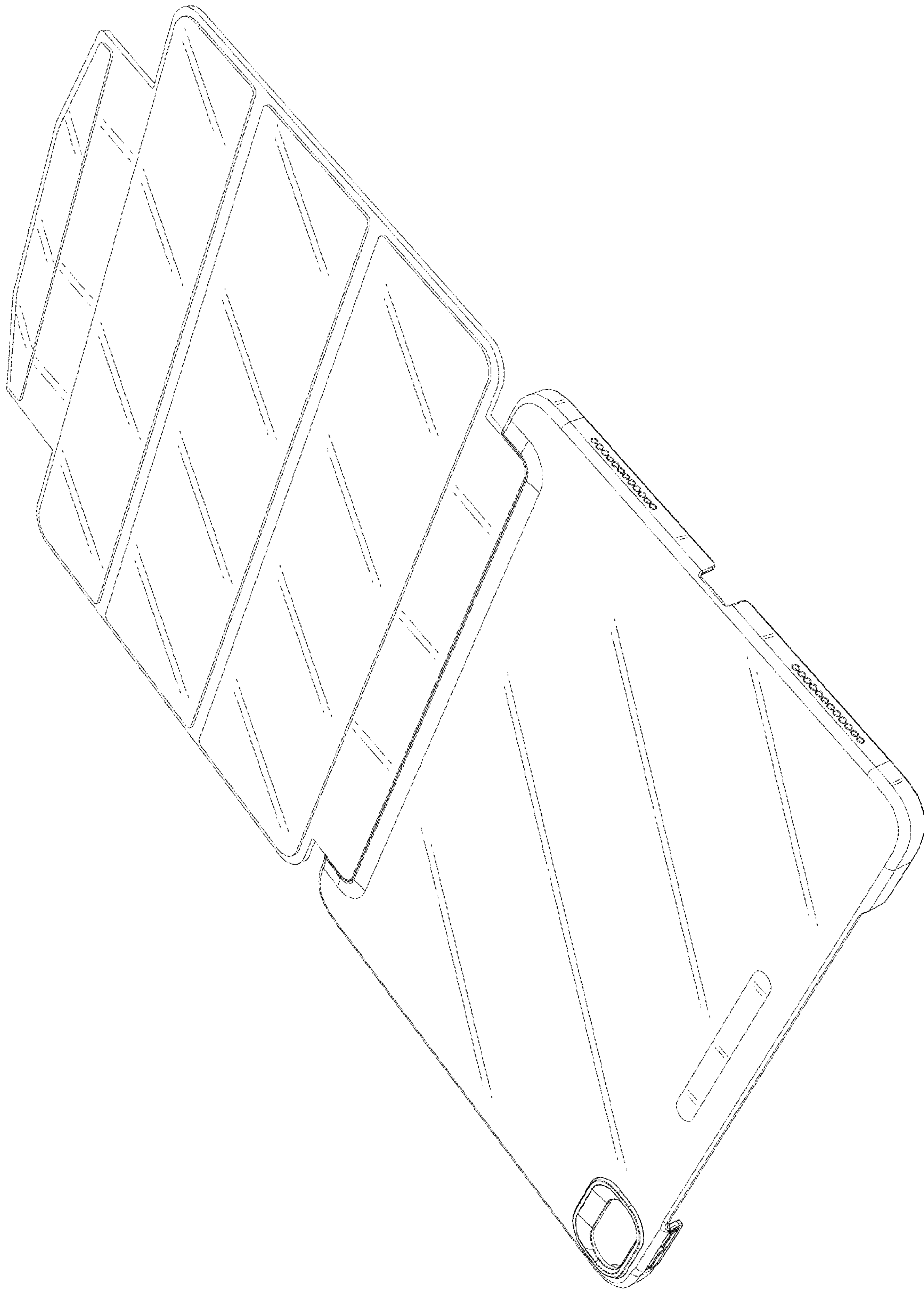

FIG. 56