



US00D970460S

(12) **United States Design Patent** (10) **Patent No.:** **US D970,460 S**  
**Akana et al.** (45) **Date of Patent:** **\*\* \*Nov. 22, 2022**

(54) **ELECTRONIC DEVICE**

(71) Applicant: **Apple Inc.**, Cupertino, CA (US)

(72) Inventors: **Jody Akana**, San Francisco, CA (US); **Molly Anderson**, San Francisco, CA (US); **Bartley K. Andre**, Palo Alto, CA (US); **Shota Aoyagi**, San Francisco, CA (US); **Anthony Michael Ashcroft**, San Francisco, CA (US); **Marine C. Bataille**, San Francisco, CA (US); **Jeremy Bataillou**, San Francisco, CA (US); **Markus Diebel**, San Francisco, CA (US); **M. Evans Hankey**, San Francisco, CA (US); **Julian Hoenig**, San Francisco, CA (US); **Richard P. Howarth**, San Francisco, CA (US); **Jonathan P. Ive**, San Francisco, CA (US); **Julian Jaede**, San Francisco, CA (US); **Duncan Robert Kerr**, San Francisco, CA (US); **Peter Russell-Clarke**, San Francisco, CA (US); **Benjamin Andrew Shaffer**, San Jose, CA (US); **Mikael Silvanto**, San Francisco, CA (US); **Sung-Ho Tan**, San Francisco, CA (US); **Clement Tissandier**, San Francisco, CA (US); **Eugene Antony Whang**, San Francisco, CA (US); **Rico Zörkendörfer**, San Francisco, CA (US)

(73) Assignee: **Apple Inc.**, Cupertino, CA (US)

(\*) Notice: This patent is subject to a terminal disclaimer.

(\*\*) Term: **15 Years**

(21) Appl. No.: **29/683,768**

(22) Filed: **Mar. 15, 2019**

(51) **LOC (13) Cl.** ..... **14-03**

(52) **U.S. Cl.**  
USPC ..... **D14/138 AA; D14/432**

(58) **Field of Classification Search**

USPC ..... D14/138 AA, 138 AB, 138 AC, 138 AD, D14/138 C, 138 G, 248, 315–318, D14/341–347, 371, 374, 432, 439; D6/308, 310; D10/50, 65, 104.1; D18/6, D18/7; D19/26, 59, 60; D21/324, 329, D21/330, 332  
CPC ... H04M 1/0202; H04M 1/0266; H04M 1/725  
See application file for complete search history.

(56) **References Cited**

U.S. PATENT DOCUMENTS

D337,569 S	7/1993	Kando	
D420,354 S	2/2000	Morales	
D504,889 S	5/2005	Andre et al.	
D548,732 S	8/2007	Cebe et al.	
D551,649 S *	9/2007	Moon	D14/138 AA
D558,756 S	1/2008	Andre et al.	
D558,757 S	1/2008	Andre et al.	
D558,758 S	1/2008	Andre et al.	
D572,685 S *	7/2008	Peng	D14/138 AD
D573,143 S	7/2008	Park et al.	
D580,387 S	11/2008	Andre et al.	
D584,272 S *	1/2009	Chung	D14/138 G
D590,793 S *	4/2009	Kim	D14/138 AC
D597,067 S	7/2009	Oh et al.	
D599,342 S	9/2009	Andre et al.	
D600,241 S	9/2009	Andre et al.	
D602,014 S	10/2009	Andre et al.	
D602,015 S	10/2009	Andre et al.	
D602,017 S	10/2009	Andre et al.	
D602,488 S	10/2009	Jiang et al.	
D603,834 S	11/2009	Lyman et al.	
D604,297 S	11/2009	Andre et al.	
D608,750 S	1/2010	He et al.	
D613,736 S	4/2010	Andre et al.	
7,697,281 B2	4/2010	Dabov et al.	
D618,204 S	6/2010	Andre et al.	
D619,555 S	7/2010	Yang et al.	
D622,270 S	8/2010	Andre et al.	
D622,718 S	8/2010	Andre et al.	
D622,719 S	8/2010	Andre et al.	
D625,307 S	10/2010	Cheng	
D626,937 S	11/2010	Yeo et al.	
D627,344 S	11/2010	Chien et al.	
D627,769 S	11/2010	Kumagai	
D627,778 S	11/2010	Akana et al.	
D631,028 S	1/2011	Park et al.	
D631,458 S	1/2011	Liao et al.	

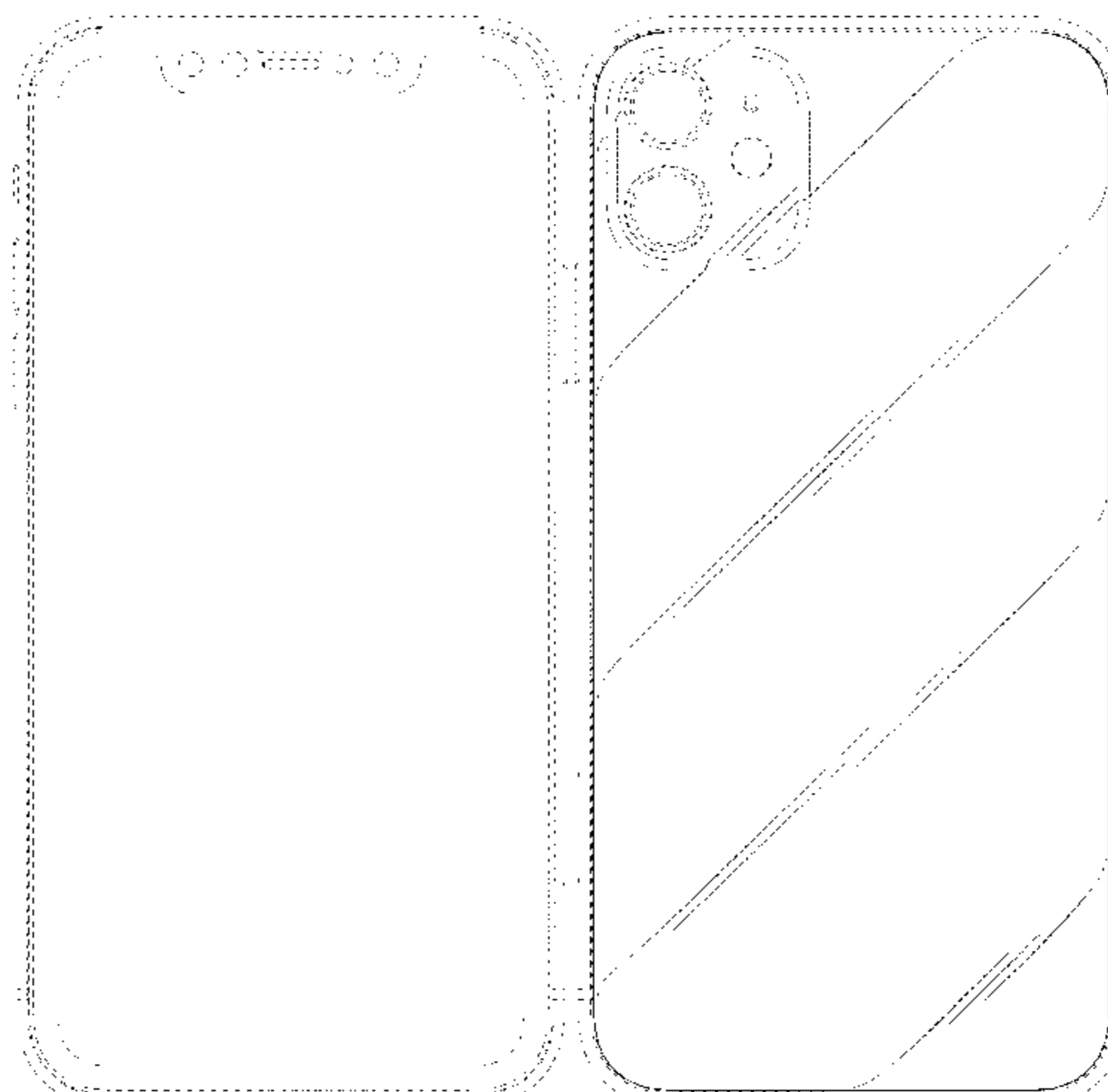

# US D970,460 S

D633,461 S	3/2011	Kim et al.	D732,497 S	6/2015	Lee et al.
D633,493 S	3/2011	Jody	D732,498 S	6/2015	Huang et al.
D633,908 S	3/2011	Akana et al.	D732,539 S	6/2015	Akana et al.
D635,113 S	3/2011	Park et al.	D733,146 S	6/2015	Akana et al.
D635,952 S	4/2011	Park et al.	D736,205 S	8/2015	Park et al.
D636,390 S	4/2011	Andre et al.	D739,391 S	9/2015	Chen et al.
D636,392 S	4/2011	Akana et al.	D741,279 S	10/2015	Tai et al.
D636,752 S	4/2011	Liao et al.	D742,351 S	11/2015	Chen et al.
D638,003 S	5/2011	Chen	D743,391 S	11/2015	Akana et al.
D638,815 S	5/2011	Lee et al.	D744,993 S	12/2015	Diebel
D639,261 S	6/2011	Garnham et al.	D746,275 S	12/2015	Mohammad
D639,763 S	6/2011	Kim et al.	D747,287 S	1/2016	Chang et al.
D639,771 S	6/2011	Chen	D749,563 S	2/2016	Akana et al.
D640,663 S	6/2011	Arnholt et al.	9,256,252 B2	2/2016	Chao
D642,563 S	8/2011	Akana et al.	D750,620 S	3/2016	Zhai
D643,396 S *	8/2011	Hou ..... D14/138 AA	D750,729 S	3/2016	Sheikh et al.
D648,303 S	11/2011	Park et al.	D751,051 S	3/2016	Cho et al.
D649,968 S	12/2011	Li	D752,010 S	3/2016	Kim
D653,645 S	2/2012	Park	D752,037 S	3/2016	Akana et al.
D654,887 S	2/2012	McManigal et al.	9,274,142 B2	3/2016	Nickel et al.
D656,477 S	3/2012	Yl et al.	D754,125 S	4/2016	Akana et al.
D662,503 S	6/2012	Akana et al.	D759,008 S	6/2016	Akana et al.
D668,627 S	10/2012	Chung	D760,217 S	6/2016	Akana et al.
D671,905 S	12/2012	Mauritzson	D761,226 S	7/2016	Poulin
D671,937 S	12/2012	Jody et al.	D762,207 S	7/2016	Akana et al.
D672,343 S	12/2012	Jody	D762,610 S	8/2016	Joung et al.
D673,562 S	1/2013	Johnson	D767,522 S	9/2016	Wu et al.
D676,432 S	2/2013	Hasbrook et al.	D769,208 S	10/2016	Ho et al.
D677,641 S	3/2013	Sutherland et al.	9,462,094 B2	10/2016	Liu et al.
D677,642 S	3/2013	Park	D770,411 S	11/2016	Zhang
D677,657 S	3/2013	Akana et al.	D770,433 S	11/2016	Kangasmaa et al.
D680,092 S	4/2013	Tsai et al.	D771,607 S	11/2016	Kim et al.
D680,984 S	4/2013	Harmon et al.	D771,622 S	11/2016	Akana et al.
D680,995 S	4/2013	Lee	D771,623 S	11/2016	Akana et al.
D681,032 S	4/2013	Akana et al.	D772,865 S	11/2016	Akana et al.
D681,632 S	5/2013	Akana et al.	D774,499 S	12/2016	Fathollahi
D683,711 S	6/2013	Hofer et al.	D777,700 S	1/2017	Kwon et al.
D684,571 S	6/2013	Akana et al.	9,537,219 B2	1/2017	Ayala et al.
D686,586 S	7/2013	Cho et al.	D778,867 S	2/2017	Husgafvel et al.
D687,404 S	8/2013	Yoshimura	D779,484 S	2/2017	Akana et al.
D687,793 S	8/2013	Park	9,577,318 B2	2/2017	Pascolini et al.
D688,218 S	8/2013	Lee	D780,711 S *	3/2017	Song ..... D14/138 G
D688,221 S	8/2013	Zuffo et al.	D780,748 S	3/2017	Wang et al.
D688,660 S	8/2013	Akana et al.	D781,807 S	3/2017	Hubbard et al.
D689,455 S	9/2013	Daniel	9,594,147 B2	3/2017	Han et al.
8,526,180 B2	9/2013	Rayner	D783,565 S	4/2017	Kim et al.
D690,693 S	10/2013	Akana et al.	D783,566 S	4/2017	Kim et al.
D691,133 S	10/2013	Akana et al.	D783,602 S	4/2017	Akana et al.
D692,881 S	11/2013	Akana et al.	D784,314 S	4/2017	Ryu et al.
D693,324 S	11/2013	Wang	D784,315 S	4/2017	Ryu et al.
D693,785 S	11/2013	Sutherland et al.	D786,229 S	5/2017	Kim et al.
D696,247 S	12/2013	Kim	D790,535 S	6/2017	Akana et al.
D697,911 S	1/2014	McManigal et al.	D792,366 S	7/2017	Zhang et al.
D698,770 S	2/2014	Park	D792,386 S	7/2017	Lee et al.
D698,773 S	2/2014	Wildner	D794,623 S	8/2017	Kwon et al.
8,640,868 B2	2/2014	O'Dowd et al.	D796,497 S	9/2017	Kim et al.
D702,219 S	4/2014	Suk	9,761,927 B2	9/2017	Kasar et al.
D705,188 S	5/2014	Chau et al.	D798,851 S	10/2017	Kim et al.
D706,235 S	6/2014	Kim	D798,852 S	10/2017	Kim et al.
D706,251 S	6/2014	Park	D800,710 S	10/2017	Ryu et al.
D706,301 S	6/2014	Akana et al.	D800,716 S	10/2017	Akana et al.
D706,776 S	6/2014	Akana et al.	D801,321 S	10/2017	Kim et al.
D707,223 S	6/2014	Akana et al.	D803,209 S	11/2017	Akana et al.
D708,608 S	7/2014	Sugiyama et al.	D804,469 S *	12/2017	Lee ..... D14/341
D710,815 S	8/2014	Kim et al.	D805,495 S	12/2017	Kester et al.
8,804,353 B2	8/2014	Montevirgen et al.	D806,705 S	1/2018	Akana et al.
D712,384 S	9/2014	Hibi	D810,715 S	2/2018	Cho et al.
D712,405 S	9/2014	Akana et al.	D818,980 S *	5/2018	Kim ..... D14/138 G
D713,833 S	9/2014	Wilkey	D835,620 S	12/2018	Akana et al.
D715,794 S *	10/2014	Zhou ..... D14/341	D842,853 S *	3/2019	Akana ..... D14/341
D718,268 S	11/2014	Wu et al.	D863,276 S *	10/2019	Seo ..... D14/248
8,879,245 B2	11/2014	Kim	D868,059 S *	11/2019	Akana ..... D14/341
D719,941 S	12/2014	Kim et al.	D877,109 S *	3/2020	Kim ..... D14/138 G
D720,747 S	1/2015	Kim et al.	D890,153 S *	7/2020	Kim ..... D14/248
D721,344 S	1/2015	Lee et al.	D890,713 S *	7/2020	Xu ..... D14/138 G
8,933,347 B2	1/2015	Kiple et al.	D895,626 S *	9/2020	Akana ..... D14/439
D724,572 S	3/2015	Wildner	D896,232 S *	9/2020	Akana ..... D14/439
8,989,826 B1	3/2015	Connolly	D903,618 S *	12/2020	Fujimura ..... D14/138 G
D731,481 S	6/2015	Akana et al.	D903,619 S *	12/2020	Fujimura ..... D14/138 G

# US D970,460 S

D903,620 S *	12/2020	Fujimura .....	D14/138 G	CN	303647864 S	4/2016
D903,622 S *	12/2020	Fujimura .....	D14/138 G	CN	303774339 S	8/2016
D905,065 S *	12/2020	Akana .....	D14/439	CN	303805687 S	8/2016
D905,696 S *	12/2020	Akana .....	D14/439	CN	304095914 S	4/2017
D919,589 S *	5/2021	Ji .....	D14/138 G	CN	304095915 S	4/2017
D920,274 S *	5/2021	Seo .....	D14/138 G	CN	304130421 S	5/2017
D921,602 S *	6/2021	Wang .....	D14/138 C	CN	303453788 S	11/2017
D924,241 S *	7/2021	Akana .....	D14/439	EM	002088591-0001	8/2012
D926,769 S *	8/2021	Akana .....	D14/439	GB	6085047	* 3/2020
D926,770 S *	8/2021	Akana .....	D14/439	GB	6085049	* 3/2020
D929,982 S *	9/2021	Tadesse .....	D14/250	GB	6090054	* 5/2020
D929,984 S *	9/2021	Wu .....	D14/250	GB	6090064	* 5/2020
D939,485 S *	12/2021	Kim .....	D14/248	GB	6096543	* 7/2020
D939,486 S *	12/2021	Kim .....	D14/248	IN	210894-0001	6/2007
D939,487 S *	12/2021	Kim .....	D14/248	IN	210897-0001	6/2007
D940,118 S *	1/2022	Kim .....	D14/248	IN	2768570001	2/2016
D940,119 S *	1/2022	Kim .....	D14/248	JP	D1326330 S	4/2008
D940,722 S *	1/2022	Akana .....	D14/439	JP	D1351277 S	2/2009
D941,792 S *	1/2022	Wang .....	D14/248	JP	D1456810 S	12/2012
D941,793 S *	1/2022	Lee .....	D14/138 G	JP	D1469635 S	5/2013
D942,437 S *	2/2022	Wang .....	D14/248	JP	D1478342 S	9/2013
D944,753 S *	3/2022	Akana .....	D14/138 G	JP	1548987 S	5/2016
D945,977 S *	3/2022	Akana .....	D14/138 G	JP	1563161 S	11/2016
D945,978 S *	3/2022	Akana .....	D14/138 G	JP	1574816 S	4/2017
D946,547 S *	3/2022	Kim .....	D14/138 G	JP	D1600999	4/2018
D946,548 S *	3/2022	Kim .....	D14/138 G	KR	3006068280	7/2011
D947,826 S *	4/2022	Kim .....	D14/248	KR	300849814	4/2016
D947,849 S *	4/2022	Akana .....	D14/439	KR	300902453	9/2017
D947,850 S *	4/2022	Akana .....	D14/439	RU	85816	7/2013
D947,851 S *	4/2022	Akana .....	D14/439	RU	89999 U1	9/2014
D949,121 S *	4/2022	Doi .....	D14/138 G	RU	90363 U1	10/2014
D950,511 S *	5/2022	Kwon .....	D14/138 G	RU	104650 U1	8/2017
D951,897 S *	5/2022	Ha .....	D14/138 G	TW	D149042 S	9/2012
2009/0247244 A1	10/2009	Mittleman et al.		TW	D169484 S	8/2015
2011/0050560 A1	3/2011	Foster et al.		TW	D172231 S	12/2015
2011/0117971 A1	5/2011	Kim et al.		WO	WO-DM080555 S	2/2013
2011/0268218 A1	11/2011	Kang et al.		WO	DM/095015	2/2017
2012/0088555 A1	4/2012	Hu				
2012/0168577 A1	7/2012	Cheng				
2012/0170189 A1	7/2012	Li et al.				
2012/0329535 A1	12/2012	Kuo				
2013/0321237 A1	12/2013	Woodhull et al.				
2013/0331156 A1	12/2013	Lui				
2014/0221056 A1 *	8/2014	Gandhi .....	H04B 1/3888 455/575.8			
2016/0191095 A1	6/2016	Santelli				

## FOREIGN PATENT DOCUMENTS

CN	300928488 S	5/2009
CN	301134880 S	2/2010
CN	301139661 S	2/2010
CN	301161836 S	3/2010
CN	301271887 S	6/2010
CN	301300814 S	8/2010
CN	301794564 S	1/2012
CN	301867415 S	3/2012
CN	302242618 S	12/2012
CN	302268386 S	1/2013
CN	302279529 S	1/2013
CN	302321988 S	2/2013
CN	302333118 S	2/2013
CN	302350915 S	3/2013
CN	302404040 S	4/2013
CN	302430473 S	5/2013
CN	202998218 U	6/2013
CN	302455942 S	6/2013
CN	302476338 S	6/2013
CN	302560014 S	9/2013
CN	302588771 S	9/2013
CN	302606411 S	10/2013
CN	302619300 S	10/2013
CN	302748579 S	2/2014
CN	302808732 S	4/2014
CN	302873818 S	7/2014
CN	302982246 S	10/2014
CN	303000183 S	11/2014
CN	303000194 S	11/2014
CN	303617715 S	3/2016

## OTHER PUBLICATIONS

Fujifilm Instax Mini Liplay Hybrid Instant Camera, date first available: Jun. 12, 2019, [retrieved Jun. 18, 2021], Retrieved from Internet, URL: <<https://www.amazon.com/Fujifilm-Instax-Liplay-Hybrid-Instant/dp/B07SH2S36Q>> (Year: 2019).\*

Apple iPhone 11, date first available: Oct. 28, 2019, [retrieved Jun. 18, 2021], Retrieved from Internet, URL: <<https://www.amazon.com/Apple-iPhone-11-64GB-Black/dp/B07ZPKN6YR?th=1>> (Year: 2019).\*

Samsung Galaxy S20, date first available: Sep. 23, 2020, [retrieved Jun. 18, 2021], Retrieved from Internet, URL: <<https://www.amazon.com/Samsung-Factory-Unlocked-Smartphone-Pro-Grade/dp/B08FYVMRM5>> (Year: 2020).\*

Apple iPhone 11 Pro and Pro Max Review, Sep. 25, 2019, [retrieved Jun. 18, 2021], Retrieved from Internet, URL: <[https://www.phonearena.com/reviews/Apple-iPhone-11-Pro-and-Pro-Max-Review\\_id4696](https://www.phonearena.com/reviews/Apple-iPhone-11-Pro-and-Pro-Max-Review_id4696)> (Year: 2019).\*

Apple iPhone 11 review, Mar. 29, 2020, [retrieved Jun. 18, 2021], Retrieved from Internet, URL: <<https://www.cnet.com/reviews/iphone-11-2019-battery-deep-fusion-review/>> (Year: 2020).\*

Apple iPhone 11 review: The iPhone for everyone?, May 27, 2020, [retrieved Jun. 18, 2021], Retrieved from Internet, URL: <<https://www.pocket-lint.com/phones/reviews/apple/149322-apple-iphone-11-review/>> (Year: 2020).\*

'How much is the iPhone 11?', Sep. 25, 2019, [retrieved Jun. 18, 2021], Retrieved from Internet, URL: <<https://www.businessinsider.com/how-much-is-iphone-11>> (Year: 2019).\*

Apple's 3 New iPhones Are All About the Cameras, Sep. 10, 2019, [retrieved Jun. 18, 2021], Retrieved from Internet, URL: <<https://www.wired.com/story/apple-iphone-11/>> (Year: 2019).\*

iPhone 11 first impressions, Sep. 20, 2019, [retrieved Jun. 18, 2021], Retrieved from Internet, URL: <<https://www.cultofmac.com/653586/iphone-11-first-impressions/>> (Year: 2019).\*

How to choose between the iPhone 11 Pro, 11 ProMax, and 11, Sep. 11, 2019, [retrieved Jun. 18, 2021], Retrieved from Internet, URL:

- <<https://www.theverge.com/2019/9/11/20847304/apple-iphone-11-pro-max-comparison-best-specs-features-price-size-camera>> (Year: 2019).\*
- iPhone 11 review, Oct. 1, 2019, [retrieved Jun. 18, 2021], Retrieved from Internet, URL: <<https://www.theguardian.com/technology/2019/oct/01/iphone-11-review-iphone-xr-dual-camera-a13-smartphone>> (Year: 2019).\*
- The Samsung Galaxy S20 FE brings some flagshipspecs at a \$699 price, Sep. 23, 2020, [retrieved Jun. 18, 2021], Retrieved from Internet, URL: <<https://www.theverge.com/2020/9/23/21451701/samsung-galaxy-s20-fe-price-release-date-specs-features>> (Year: 2020).\*
- Apple iPhone 5 pictures, as posted at GsmArena.com [online], [retrieved on Apr. 27, 2017]. Available on the Internet, (URL: [http://www.gsmarena.com/apple\\_iphone\\_5-pictures-4910.php#image15](http://www.gsmarena.com/apple_iphone_5-pictures-4910.php#image15)), accessed on Sep. 2012.
- Apple iPhone 7 is here with a water resistant body, better cameras, 256GB capacity & no headphone jack, posted Sep. 8, 2016, [retrieved Aug. 28, 2017]. Retrieved from Internet, (URL: <https://collinsdail.blogspot.com/2016/09/apple-iphone-7-is-here-withwater.html>).
- Apple iPhone 7 and 7plus | New Camera, posted Sep. 8, 2016, [retrieved Aug. 28, 2017]. Retrieved from Internet, (URL: <http://sujoyrdas.blogspot.com/2016/09/apple-iphone-7-and-7plus-new-camera.html>).
- Carlson, Ronald, Tapscape.com, “Translucent iPhone: Will Apple Revisit G3 iMac?,” accessed at <http://www.tapscape.com/translucent-iphone/>, accessed on Apr. 3, 2013, 3 pages.
- ConceptsiPhone, “iPhone 8 and iPhone 8 Plus—Introducing” Youtube, Oct. 7, 2016, accessed at (<https://www.youtube.com/watch?v=WSf8aJYCjg>).
- Cultofandroid, “This Android-Powered iPhone 5C Clone Will Cost Just \$100 in China” accessed at [http://www.cultofandroid.com/40408/this-android-powered-iphone-5c-clone-will-cost-just-100-in-china/?utm\\_campaign=twitter&utm\\_medium=twitter&utm\\_source=twitter](http://www.cultofandroid.com/40408/this-android-powered-iphone-5c-clone-will-cost-just-100-in-china/?utm_campaign=twitter&utm_medium=twitter&utm_source=twitter), accessed on Aug. 27, 2013, 2 pages.
- Daily Life News, “iPhone 5s Leaked Images Hint 2 Different Screen Sizes.” accessed at <https://www.youtube.com/watch?v=8tcTHa63WHI>, accessed on Apr. 10, 2013, 4 pages.
- Engadget, “Meizu’s M8? Apple lawyers, start your engines”, accessed at <http://www.engadget.com/2007/01/29/meizus-m8-apple-lawyers-start-your-engines/>, accessed on Jan. 29, 2007, 3 pages.
- Faulkner, Cameron, “Essential Phone Review”, Tech Radar, [retrieved on Nov. 25, 2017], 2017, accessed at Retrieved from the Internet: (URL: <http://www.techradar.com/reviews/essential-phone>).
- Gokey, M., “Lg G3 vs. HTC One M8: Which Android Flag Should iPhone Haters Fly?”, published Sep. 18, 2014, accessed at [www.digitaltrends.com/mobile/lg-g3-vs-htc-one-m8/](http://www.digitaltrends.com/mobile/lg-g3-vs-htc-one-m8/), 12 pages.
- Gsmarena, “Nokia Lumia 820”, accessed at [http://www.gsmarena.com/nokia\\_lumia\\_820-4968.php](http://www.gsmarena.com/nokia_lumia_820-4968.php), accessed on Aug. 29, 2013, 2 pages.
- Gsmarena, “Xiaomi MI-2 ”, accessed at [http://www.gsmarena.com/xiaomi\\_mi\\_2-4928.php](http://www.gsmarena.com/xiaomi_mi_2-4928.php), accessed on Aug. 29, 2013, 2 pages.
- Gsmarena, “Xiaomi MI-2s ”, accessed at [http://www.gsmarena.com/xiaomi\\_mi\\_2s-5397.php](http://www.gsmarena.com/xiaomi_mi_2s-5397.php), accessed on Aug. 29, 2013, 2 pages.
- Hands-On With an iPhone 8 Dummy Model, posted Aug. 10, 2017, [retrieved Aug. 28, 2017]. Retrieved from Internet, (URL: <https://www.youtube.com/watch?v=YuQUBhOAbUM>).
- Identify your iPhone Model, Retrieved from the Internet URL: <https://support.apple.com/en-us/HT201296>.
- “iPhone 6, Une Enieme Maquette Comparee Avec L’iPhone 5s,” published May 3, 2014, accessed at <http://www.nowhereelse.fr/iphone-6-maquette-comparee-iphone-5s-97315/>, 2 pages.
- K11 Bumper vs. RhinoShield Crash Guard: Super Thin Protective Bumpers for iPhone 6s Plus!, posted Feb. 23, 2016, [retrieved Jan. 26, 2018]. Retrieved from Internet, <[url:https://www.youtube.com/watch?v=eX5ETZkOhj4](https://www.youtube.com/watch?v=eX5ETZkOhj4)>, 3 pages.</url:<a>
- MacManus, Christopher, cnet.com, “Artist pictures a budget iPhone—in color.” accessed at <http://www.cnet.com/au/news/artist-pictures-a-budget-iphone-in-color/>, accessed at Mar. 21, 2013, 4 pages.
- Mayo, B., “Purported iPhone 6 Pictures Show Protruding Camera, Rounded Edges,” 9to5Mac.com, accessed at <http://9to5mac.com/2014/03/31/purported-iphone-6-pictures-show-protruding-camera-rounded-edges/>, 23 pages.
- Mia P., “Apple Leak Reveals All Glass Phone With 3D Sensor; Touch Bar Feature Redefines Emoji Use; Is This iPhone 8?” GameNGuide, Oct. 31, 2016, accessed at (<http://www.gamenguide.com/articles/60727/20161031/apple-leak-reveals-all-glass-phone-with-3d-sensor-touch-bar-feature-redefines-emoji-use-is-this-iphone-8.htm>).
- Nokia, “Nokia Lumia 820—Our most versatile Lumia”, accessed at <http://www.nokia.com/global/products/phone/lumia820/>, accessed on Aug. 29, 2013, 6 pages.
- @NowhereElseFr, “Just Another Purported #iPhone6 or #iPhoneAir Dummy . . . #Apple,” published May 4, 2014, accessed at <https://twitter.com/NowhereElseFr/status/462938116924264448/photo/1>, 5 pages.
- Photo-John, “Apple’s iPhone 5 Camera—What’s New?”, as archived at <https://web.archive.org/web/20140805181048/http://www.photographyreview.com/reviews/apple-iphone-5-camera-whats-new>, published Sep. 12, 2012, 3 pages.
- Sharp Aquos S2 is a Nearly Bezel-Less Phone with Mid-Range Specs, Mashable, Aug. 8, 2017, Retrieved from the Internet:(URL: <http://mashable.com/2017/08/08/sharp-aquos-s2/#C05q3N0tzOqV>), 10 Pages.
- “Sharp Executive Confirms iPhone 8 to Use OLED Display; Limited to Only Premium 5.5-inch Plus Model” Oct. 29, 2016, accessed at (<http://www.redsn0w.us/2016/10/sharp-executive-confirms-iphone-8-to.html>).
- Stuff Staff in News, stuffmideast.com “Apple’s new iPhone to come in a five colours.” accessed at <http://stuffmideast.com/2013/04/11/151344/apples-new-iphone-to-come-in-a-five-colours/>, accessed on Apr. 11, 2013, 1 page.
- stuff.tv, “Spare wallets rejoice, the plastic budget iPhone 5S cometh, The iPhone 5S may not be an incremental increase but a decrease, in price and build quality.” accessed at <http://www.stuff.tv/apple/sparse-wallets-rejoice-plastic-budget-iphone-5s-cometh/news>, accessed on Mar. 23, 2013, 1 page.
- Swift, “BBK Vivo Xplay X510W Review,” published Oct. 21, 2013, accessed at <http://chinesetech.net/2013/10/21/bbk-vivo-xplay-x510w-review/>, 12 pages.
- TechDesigns, “iPhone 8 Official 2017—Concept” Youtube, Oct. 27, 2016, accessed at (<https://www.youtube.com/watch?v=LYUJYLD1XR0>).
- welectronics.com, “Xiaomi MI 2 GSM unlocked,” accessed at <http://www.welectronics.com/gsm/misc/XIAOMI-MI-2.HTML?gclid=CK7Nr9bv-rYCFYOo4AodZ0EAEW>, accessed at Aug. 29, 2013, 2 pages.
- Wu, Debbie, “All three iPhone 8 models to have glass backs” Nikkei Asian Review, Oct. 26, 2016, accessed at (<https://asia.nikkei.com/Business/Companies/All-three-iPhone-8-models-to-have-glass-backs?page=1>).
- Brownlee, Marques, “Apple iPhone X Unboxing!” Youtube.com, Oct. 31, 2017, Available at <<https://youtu.be/I0DoQYGZt8M?t=68>>.
- Gorsler, Fabian, “Leak Suggests Apple Will Release 3 New iPhone Models in 2018” Highsnobiety.com, Nov. 14, 2017, Available at <<https://www.highsnobiety.com/2017/11/14/three-new-iphones-2018/>>.
- Karmakar, Amit, “The iPhone X plus 2018 Dummy model and leaks” Youtube.com, Dec. 1, 2017, Available at <<https://www.youtube.com/watch?v=IpEesplOd4>>.
- Maggio, Edoardo, “These renders show what Apple might have planned for the successor to the iPhone X” BusinessInsider.com, Jan. 24, 2018, Available at <<https://www.businessinsider.com.au/martin-hajek-renders-apple-2018-iphone-x-successor-2018-1?r=US&IR=T>>.
- EVERYTHINGAPPLEPRO, “The 2018 iPhone X Plus Will be BIG!” Youtube.com, Feb. 12, 2018, Available at <<https://youtu.be/m2iMjpaKTeQ?t=14>>.
- Verykool Spark LTE SL5011 review: All that glitters is not gold, posted May 24, 2016, [retrieved Sep. 30, 2018]. Retrieved from Internet, URL:<https://www.androidguys.com/reviews/verykool-spark-lte-sl5011-review-all-that-glitters-is-not-gold/>.
- @OnLeaks, “#iPhoneX!!! Yes, time has already come to meet the new #iPhone . . . .” Published Jan. 6, 2019, accessed at <https://twitter.com/OnLeaks/status/1081902300434780161>, 5 pages.

Team Digit, “Exclusive: First look at 2019 Apple iPhone XI renders” digit.in, Jan. 7, 2019, accessed at <https://www.digit.in/news/mobile-phones/exclusive-first-look-at-2019-iphone-xi-renders-45655.html>, 3 pages.

\* cited by examiner

*Primary Examiner* — Messina L Smith

*Assistant Examiner* — Aram Kwon

(74) *Attorney, Agent, or Firm* — Sterne, Kessler,  
Goldstein & Fox P.L.L.C.

(57) **CLAIM**

The ornamental design for an electronic device, as shown and described.

**DESCRIPTION**

FIG. 1 is a bottom front perspective view of an electronic device showing the claimed design;

FIG. 2 is a top rear perspective view thereof;

FIG. 3 is a front view thereof;

FIG. 4 is a rear view thereof;

FIG. 5 is a left side view thereof;

FIG. 6 is a right side view thereof;

FIG. 7 is a top view thereof; and,

FIG. 8 is a bottom view thereof.

The broken lines in the figures show portions of the electronic device that form no part of the claimed design.

**1 Claim, 6 Drawing Sheets**

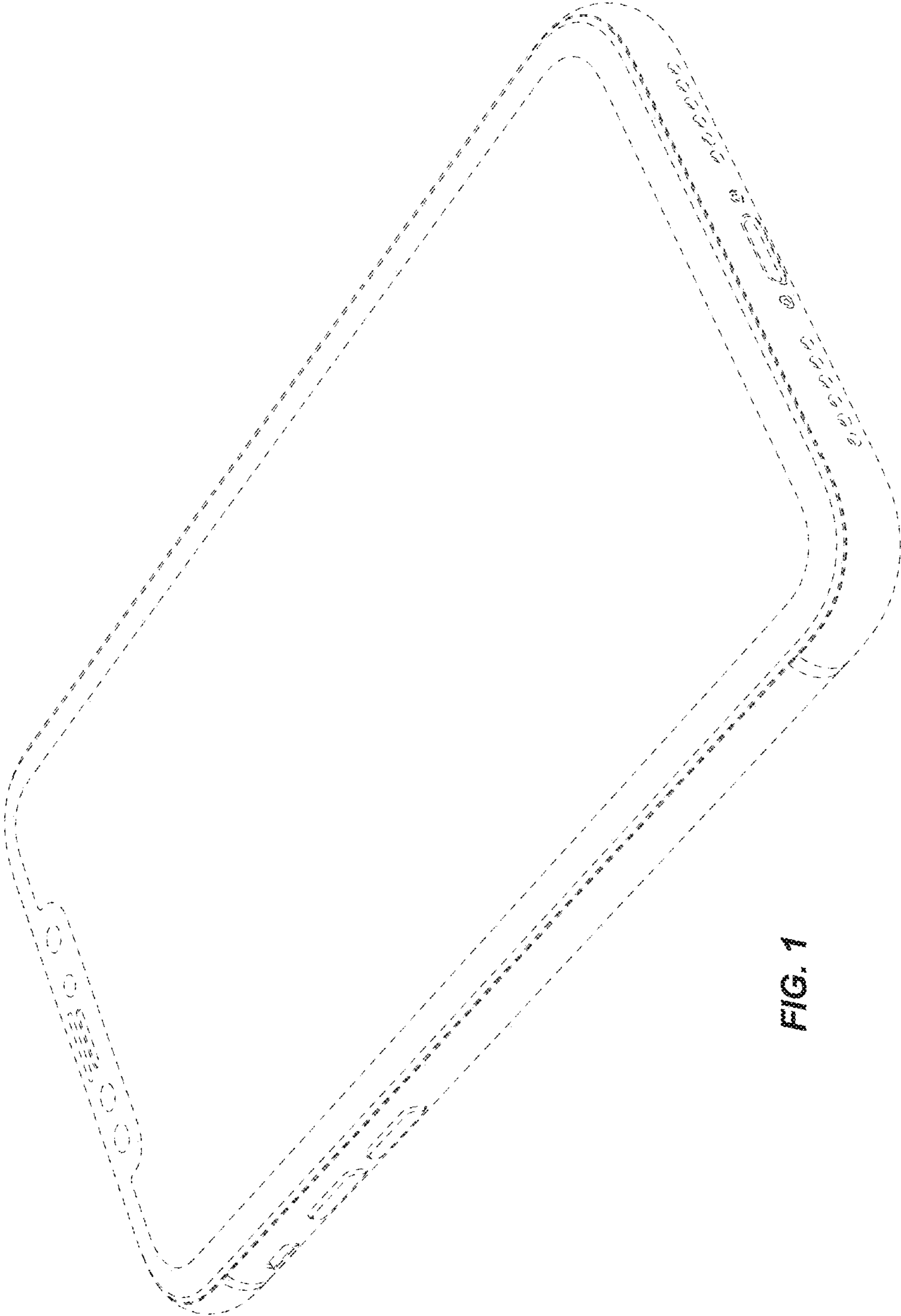

FIG. 1

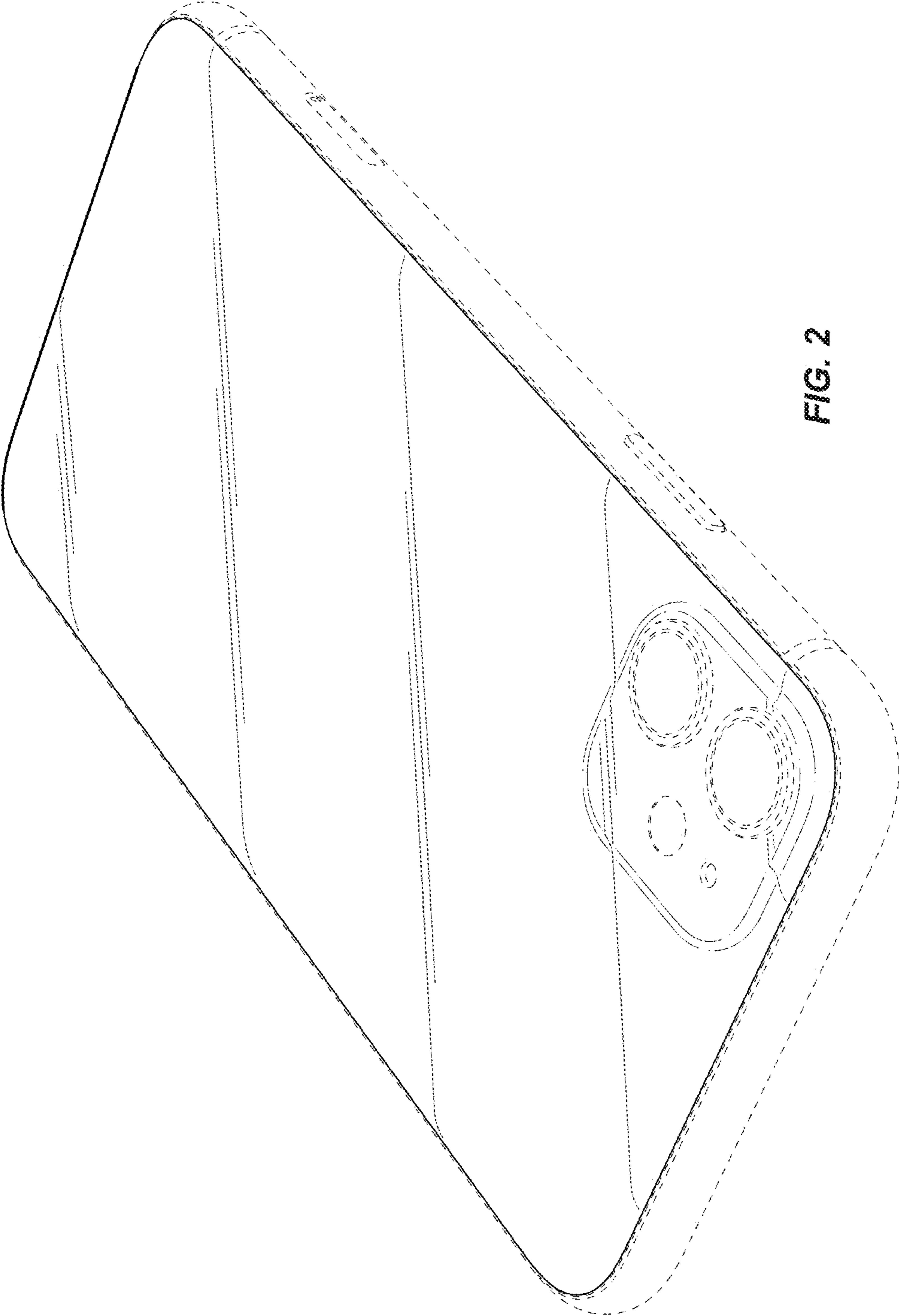

FIG. 2

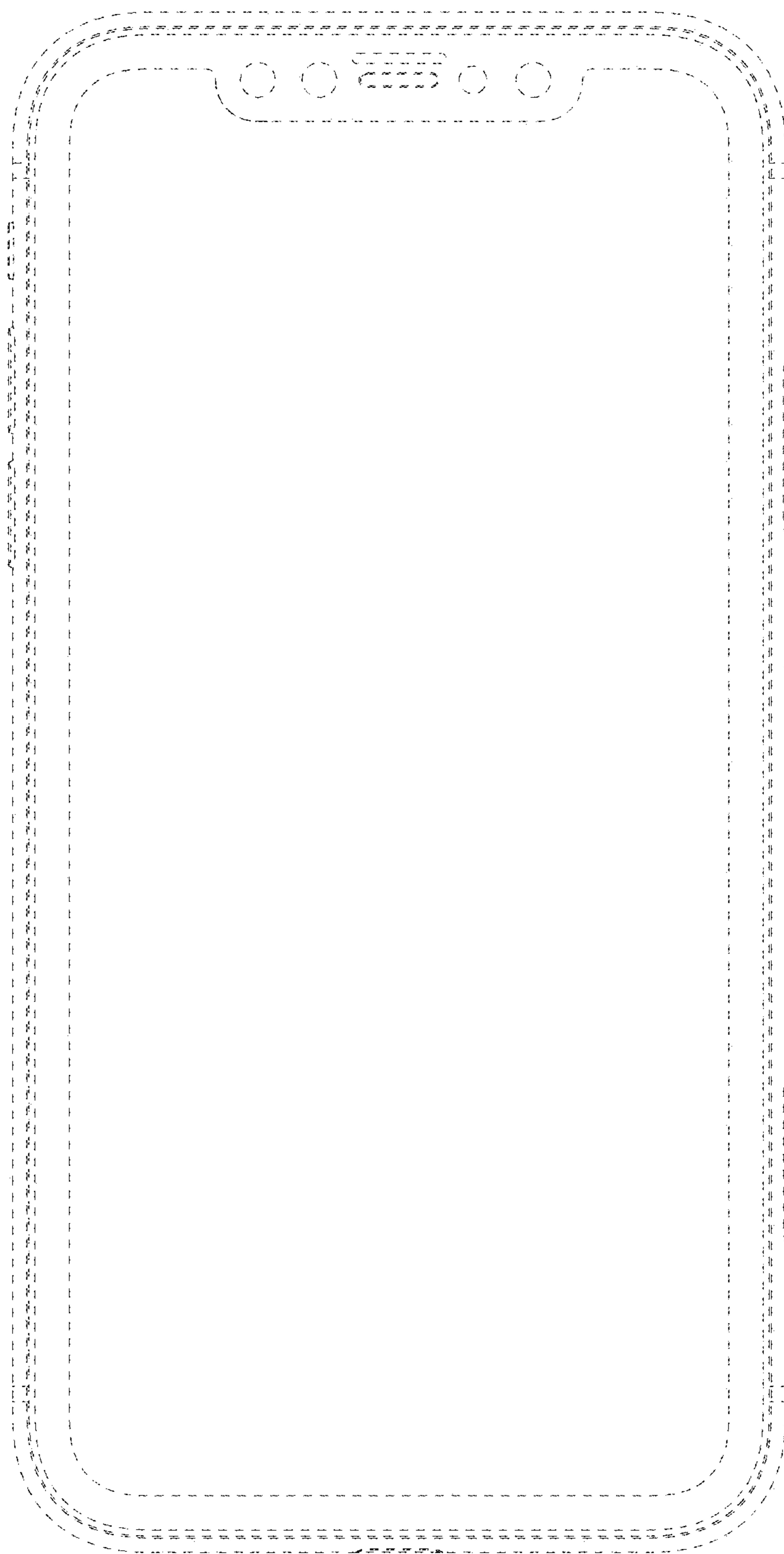

FIG. 3



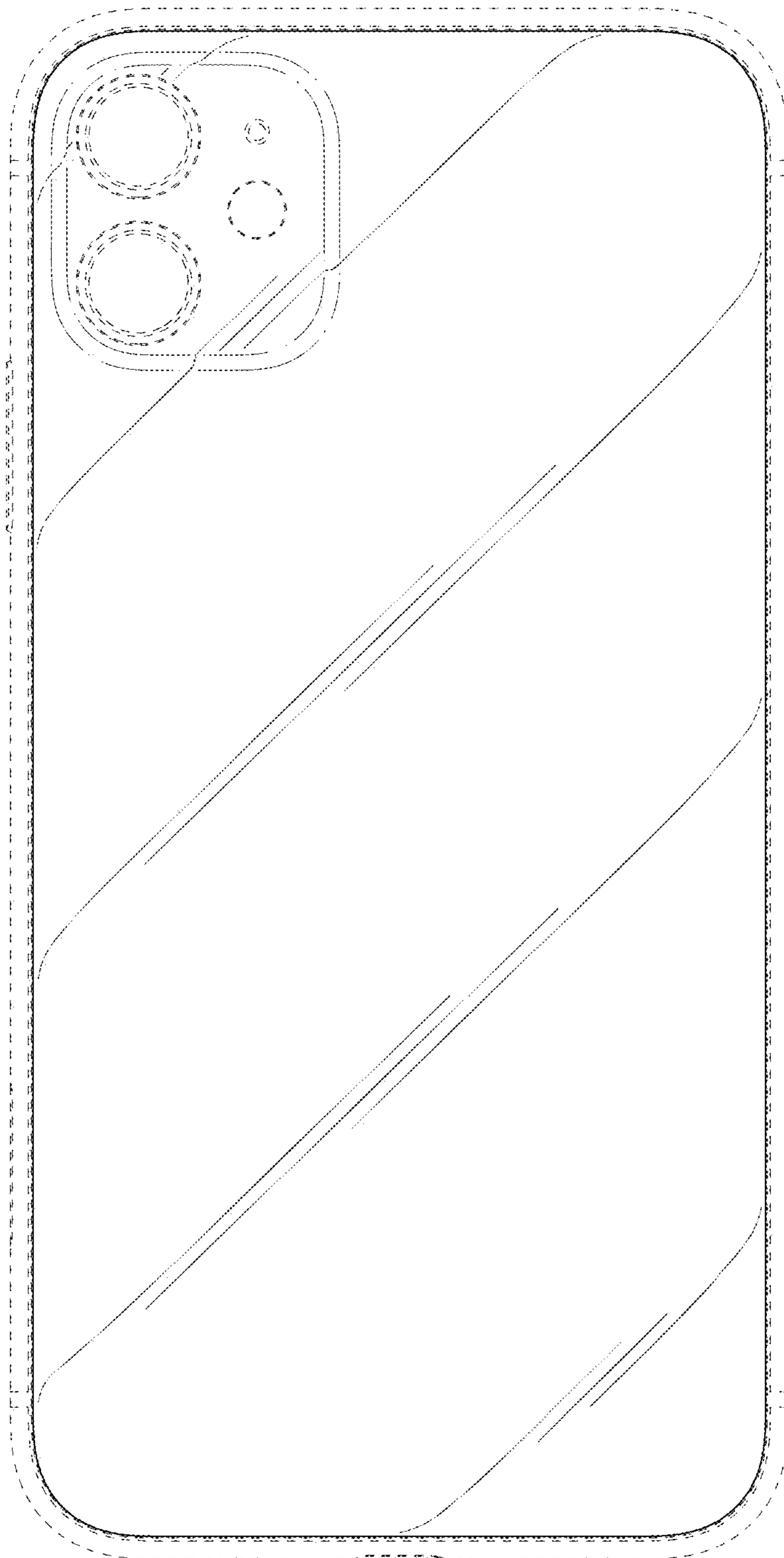

FIG. 4



FIG. 5

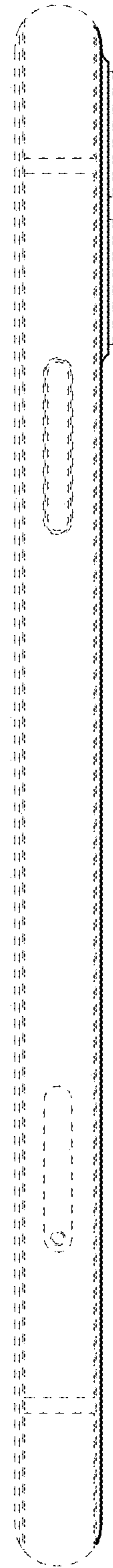
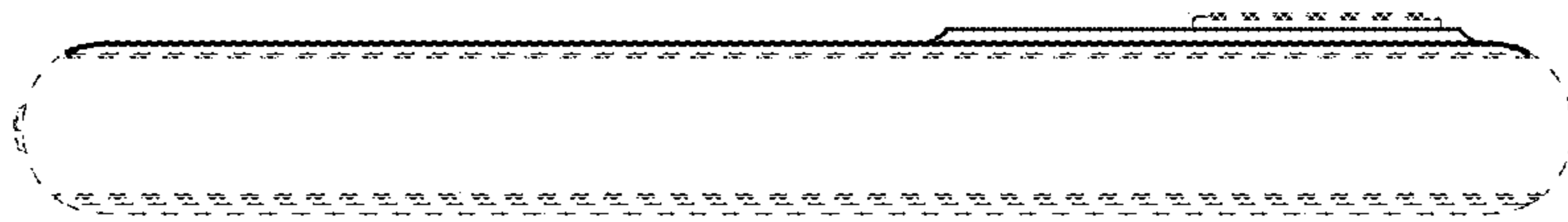
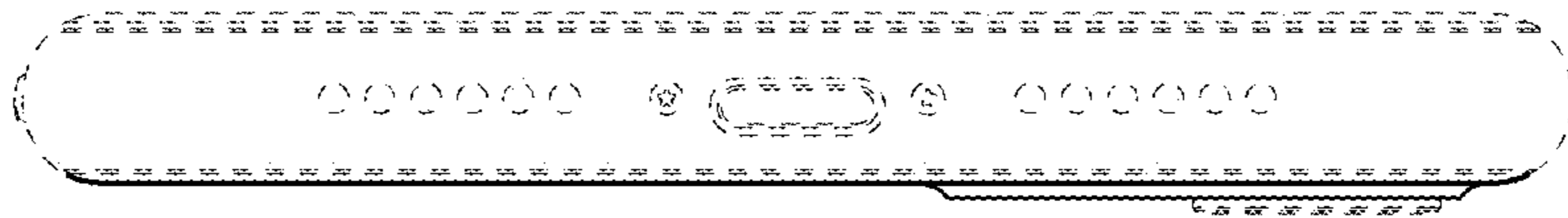

FIG. 6



**FIG. 7**



**FIG. 8**