



US00D970373S

(12) **United States Design Patent** (10) **Patent No.:** **US D970,373 S**  
**Giles** (45) **Date of Patent:** **\*\* Nov. 22, 2022**

(54) **SECURITY TAG**

(71) Applicant: **The Crown in right of the State of New South Wales acting through the Department of Primary Industries within the Department of Planning, Industry and Environment, Orange (AU)**

(72) Inventor: **Nicholas David Giles, Orange (AU)**

(73) Assignee: **THE CROWN IN RIGHT OF THE STATE OF NEW SOUTH WALES ACTING THROUGH THE DEPARTMENT OF PRIMARY INDUSTRIES WITHIN THE DEPARTMENT OF PLANNING, INDUSTRY AND ENVIRONMENT, New South Wales (AU)**

(\*\*) Term: **15 Years**

(21) Appl. No.: **29/735,694**

(22) Filed: **May 22, 2020**

(30) **Foreign Application Priority Data**

Nov. 27, 2019 (AU) ..... 201916747

(51) **LOC (13) Cl.** ..... **10-05**

(52) **U.S. Cl.**  
USPC ..... **D10/106.94**

(58) **Field of Classification Search**  
USPC ..... D10/52, 60, 104.1, 106.1, 106.9, D10/106.91-106.94, 121; D8/333, 368, D8/394, 396; D13/153; D14/433  
CPC ... Y10T 24/1498; Y10T 24/14; Y10T 24/141; Y10T 24/1406; Y10T 24/153; Y10T 292/48; B65D 2563/108; B65D 63/1081; B65D 63/10; B65B 13/027; F16L 3/233; F16L 3/2336; G09F 3/037; Y10S 24/16  
See application file for complete search history.

(56) **References Cited**

U.S. PATENT DOCUMENTS

D29,413	S	*	9/1898	Tyden	.....	D8/382
D224,960	S	*	10/1972	Wilson	.....	D8/396
D271,302	S	*	11/1983	Manning	.....	D13/168
D273,361	S	*	4/1984	Suzuki	.....	D8/394
D277,938	S	*	3/1985	Knute	.....	D10/60
5,354,021	A	*	10/1994	Farrell	.....	F16L 3/233 24/16 PB
D368,853	S	*	4/1996	Liu	.....	D8/394
5,774,944	A	*	7/1998	Choi	.....	B65D 63/1063 24/16 PB
D397,043	S	*	8/1998	Kasman	.....	D10/52
D424,923	S	*	5/2000	Lodi	.....	D8/396
D444,054	S	*	6/2001	Bernard	.....	D8/394
6,382,570	B1	*	5/2002	Simpson	.....	F16L 3/2334 24/16 PB
D459,206	S	*	6/2002	Caveney	.....	D8/396
6,449,808	B1	*	9/2002	Zappa	.....	G09F 3/037 24/16 PB

(Continued)

*Primary Examiner* — George D. Kirschbaum  
*Assistant Examiner* — Lillian Windham  
(74) *Attorney, Agent, or Firm* — Polsinelli PC

(57) **CLAIM**

The ornamental design for a security tag, as shown and described.

**DESCRIPTION**

FIG. 1 is a top view of a security tag showing my new design.  
FIG. 2 is a front view thereof.  
FIG. 3 is a bottom view thereof.  
FIG. 4 is a rear view thereof.  
FIG. 5 is a left side view thereof.  
FIG. 6 is a right side view thereof; and,  
FIG. 7 is a perspective view thereof.

**1 Claim, 4 Drawing Sheets**

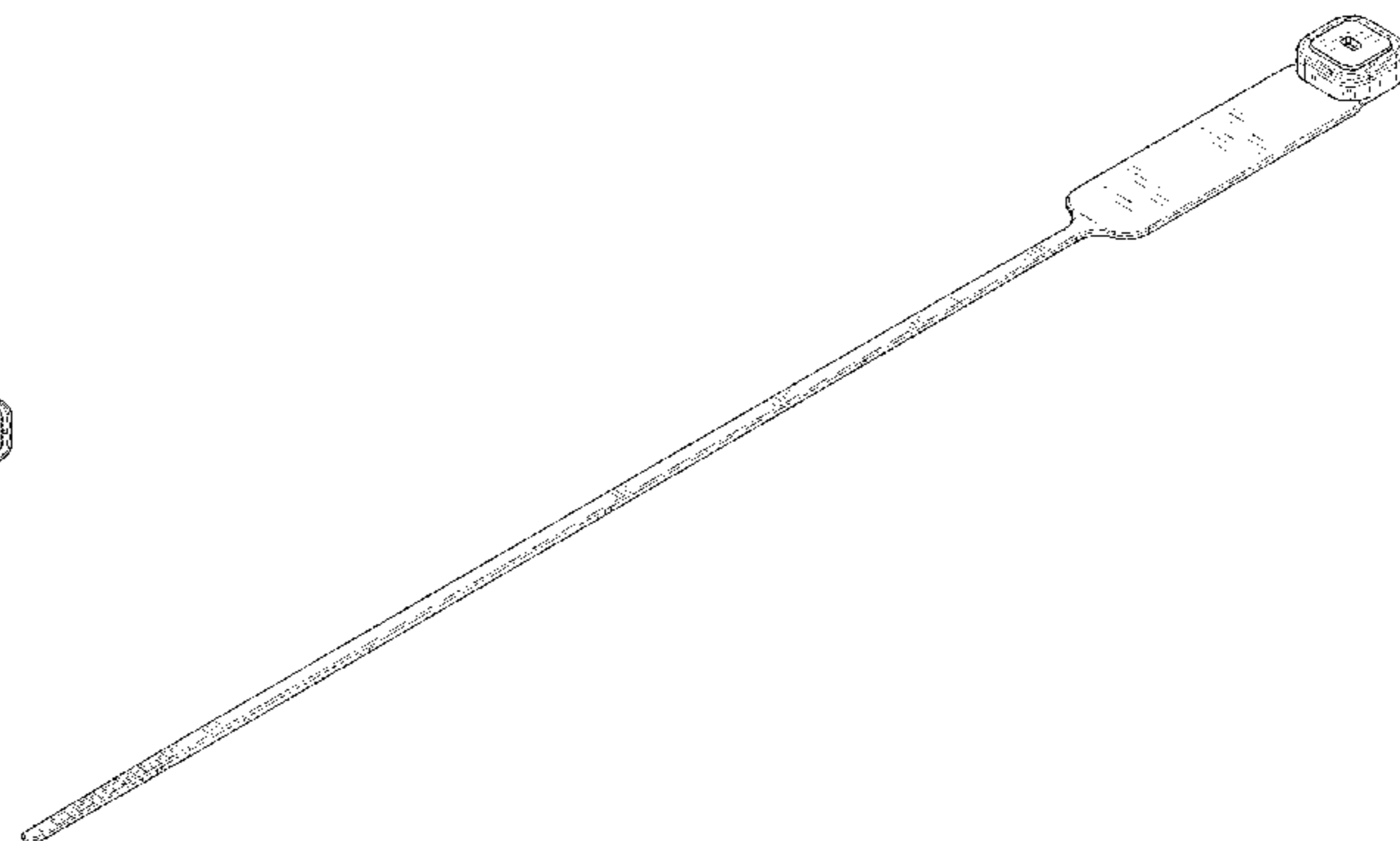
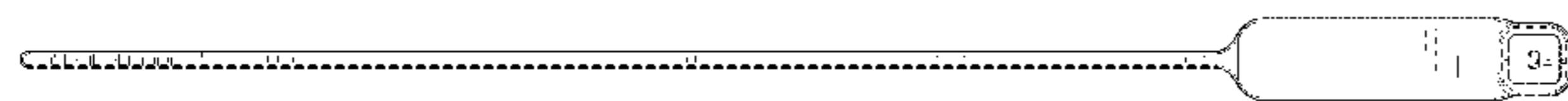

(56)

**References Cited**

## U.S. PATENT DOCUMENTS

D471,435 S \* 3/2003 Krisel ..... D8/396  
D530,600 S \* 10/2006 Krisel ..... D8/396  
D537,333 S \* 2/2007 Jowsey ..... D8/396  
7,740,210 B2 \* 6/2010 Pilon ..... B65D 63/1081  
248/74.3  
8,555,467 B2 \* 10/2013 Kelly ..... B65D 63/1081  
24/16 PB  
D695,601 S \* 12/2013 Cabrele ..... D8/396  
D741,691 S \* 10/2015 Adams ..... D8/356  
D745,225 S \* 12/2015 Siria-Womach ..... D29/129  
D748,971 S \* 2/2016 Scott ..... D8/396  
9,281,603 B2 \* 3/2016 Cullins ..... G09F 3/037  
D772,492 S \* 11/2016 Kimball ..... D29/129  
D778,148 S \* 2/2017 Iwahara ..... D8/383  
D779,314 S \* 2/2017 Adams ..... D8/383  
9,725,220 B2 \* 8/2017 Dietrich ..... B65D 63/10  
10,053,268 B1 \* 8/2018 Sickenberger ..... B65D 63/1063  
D835,495 S \* 12/2018 Votel ..... D8/356  
D844,416 S \* 4/2019 Dyer ..... F16L 3/2334  
D8/356  
10,435,214 B2 \* 10/2019 Kuperus ..... A61D 1/06  
10,472,146 B2 \* 11/2019 Abrahams ..... B65D 63/1081  
D882,373 S \* 4/2020 Baum ..... D8/333  
10,891,880 B2 \* 1/2021 Pallaro ..... G06Q 10/10  
D912,503 S \* 3/2021 King ..... D8/394  
10,975,986 B2 \* 4/2021 Sims ..... F16L 3/137  
10,994,906 B2 \* 5/2021 Chmelar ..... B65D 63/1072

\* cited by examiner



FIG.1

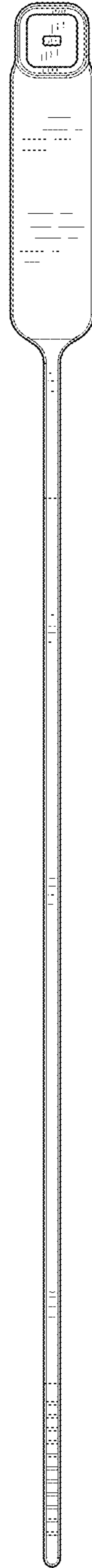

FIG.2



FIG.3

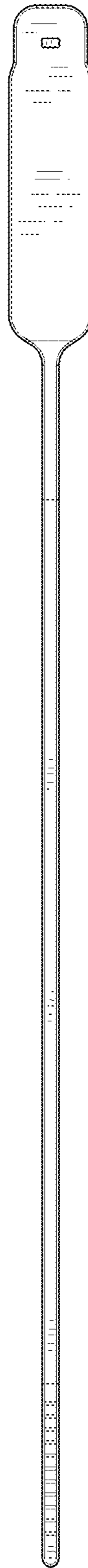

FIG.4

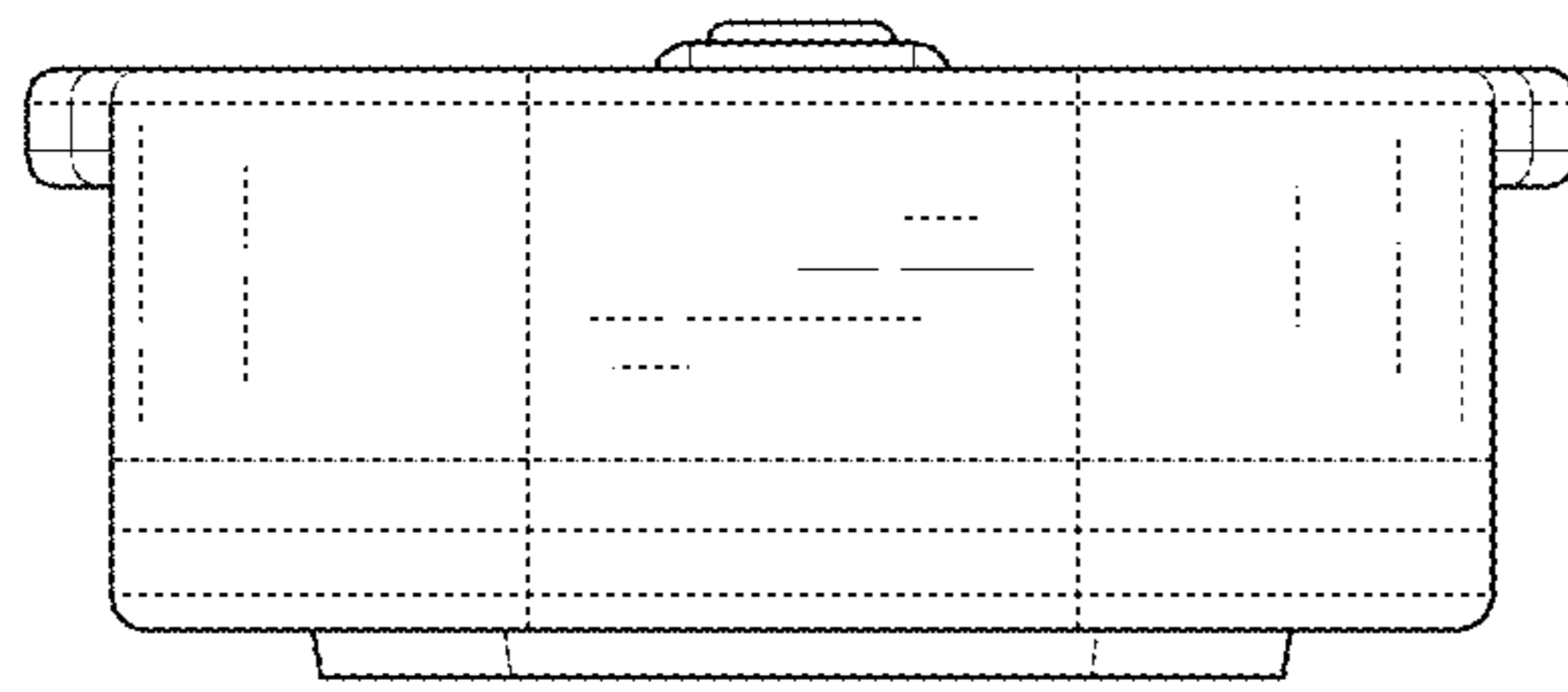

FIG. 6

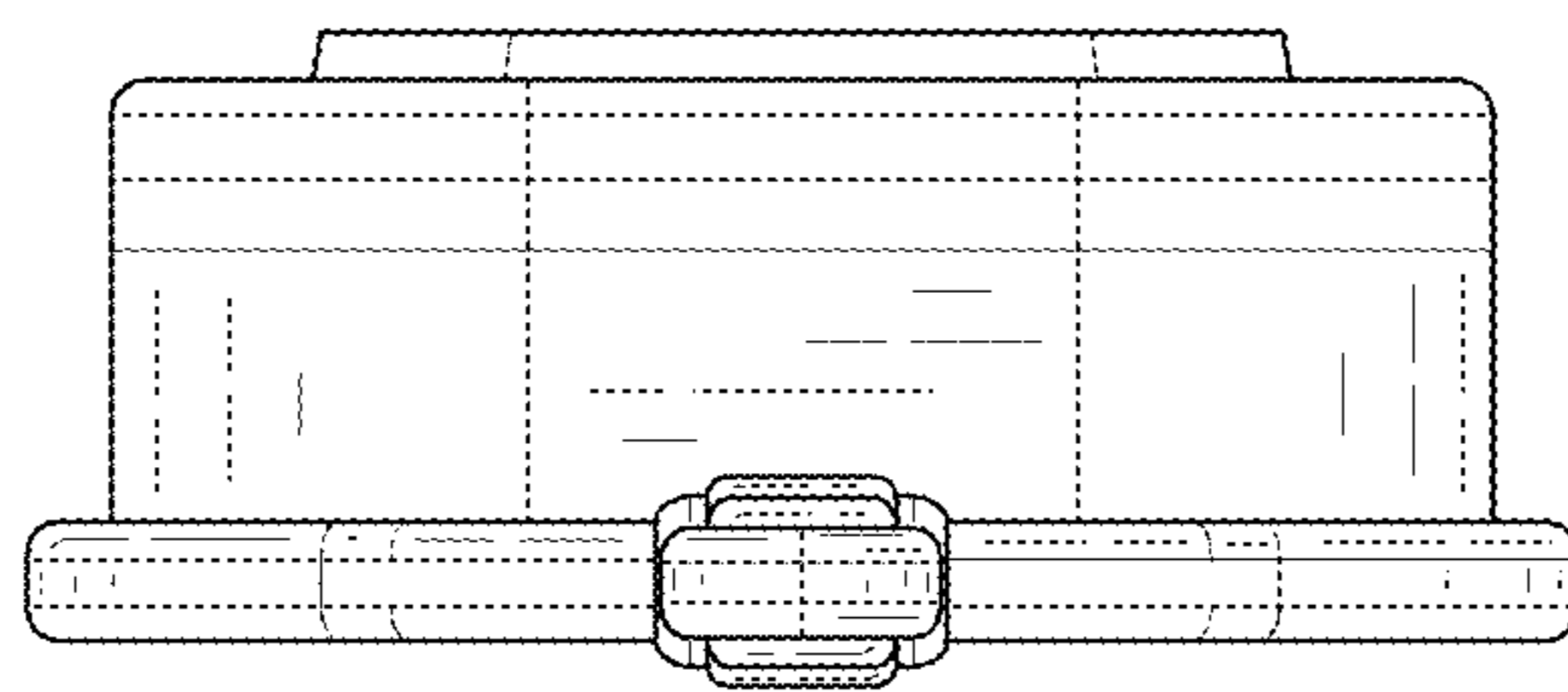

FIG. 5

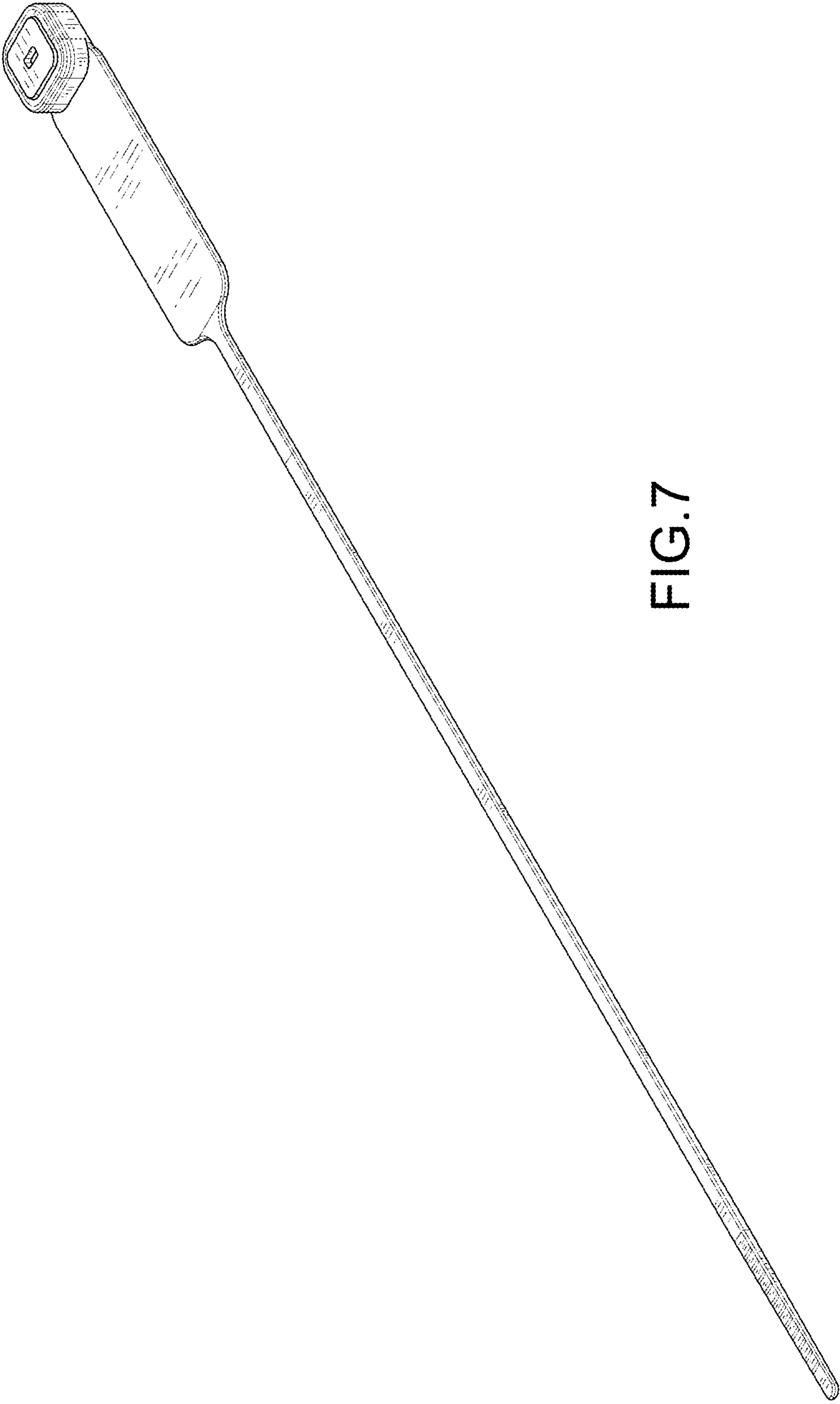

FIG. 7