



US00D970349S

(12) **United States Design Patent** (10) **Patent No.:** **US D970,349 S**  
**Pae** (45) **Date of Patent:** **\*\* Nov. 22, 2022**

(54) **COSMETIC CONTAINER**

FOREIGN PATENT DOCUMENTS

(71) Applicant: **Ju Yeon Pae**, Seoul (KR)

CN 304931820 \* 12/2018

(72) Inventor: **Ju Yeon Pae**, Seoul (KR)

CN 304955932 \* 12/2018

(\*\*) Term: **15 Years**

CN 305056727 \* 3/2019

(21) Appl. No.: **29/687,031**

EM 002041426-0004 \* 5/2012

(22) Filed: **Apr. 10, 2019**

EM 002255745-0001 \* 6/2013

(51) **LOC (13) Cl.** ..... **09-01**

GB 8204080000-2000 \* 4/2019

(52) **U.S. Cl.**  
USPC ..... **D9/687**

KR 300483720.0000 \* 3/2008

(58) **Field of Classification Search**  
USPC ..... D9/682-694, 521, 529, 559;  
D28/76-91.1

WO WO-2020145501 A1 \* 7/2020 ..... A61Q 19/10

\* cited by examiner

CPC .. A45D 34/00; A45D 34/02; A45D 2034/005;  
A45D 2034/007; A45D 2200/051-057;  
B05B 11/00-3098; B65D 83/14; B65D  
83/16; B65D 83/20; B65D 83/205; B65D  
83/206; B65D 83/207; B65D 83/22;  
B65D 83/40; B65D 83/38

*Primary Examiner* — Catherine A Tuttle

See application file for complete search history.

(57) **CLAIM**

The ornamental design for a cosmetic container, as shown and described.

(56) **References Cited**

**DESCRIPTION**

U.S. PATENT DOCUMENTS

D190,785 S	*	6/1961	Kruck	.....	D9/687
D222,824 S	*	1/1972	Newman	.....	D9/687
D321,930 S	*	11/1991	Dinand	.....	D23/360
D468,059 S	*	12/2002	Fuller	.....	D28/77
D551,561 S	*	9/2007	Bieger	.....	D9/561
D555,877 S	*	11/2007	Reinoso	.....	D9/687
D599,675 S	*	9/2009	Premo	.....	D9/687
D728,881 S	*	5/2015	Gameiro	.....	D32/45
D764,309 S	*	8/2016	Yakos	.....	D9/682
D848,695 S	*	5/2019	Tornaben	.....	D32/42
D908,965 S	*	1/2021	Pae	.....	D28/76

FIG. 1 is a front, top, and left side perspective view of a cosmetic container showing my new design;  
FIG. 2 is a front elevation view thereof;  
FIG. 3 is a rear elevation view thereof;  
FIG. 4 is a right side elevation view thereof;  
FIG. 5 is a left side elevation view thereof;  
FIG. 6 is a top plan view thereof;  
FIG. 7 is a bottom plan view thereof;  
FIG. 8 is a rear, bottom, and right side perspective view thereof; and,  
FIG. 9 is an enlarged view of portion 9 shown in FIG. 1.

The logo "XUXONI" & "±" shown on top end in FIGS. 1 and 6 is a trademark and the name of the owner of the trademark is "Ju Yeon PAE".

The dot-dash broken lines encircling portions of the claimed design that are illustrated in enlargement form no part of the claimed design.

**1 Claim, 9 Drawing Sheets**

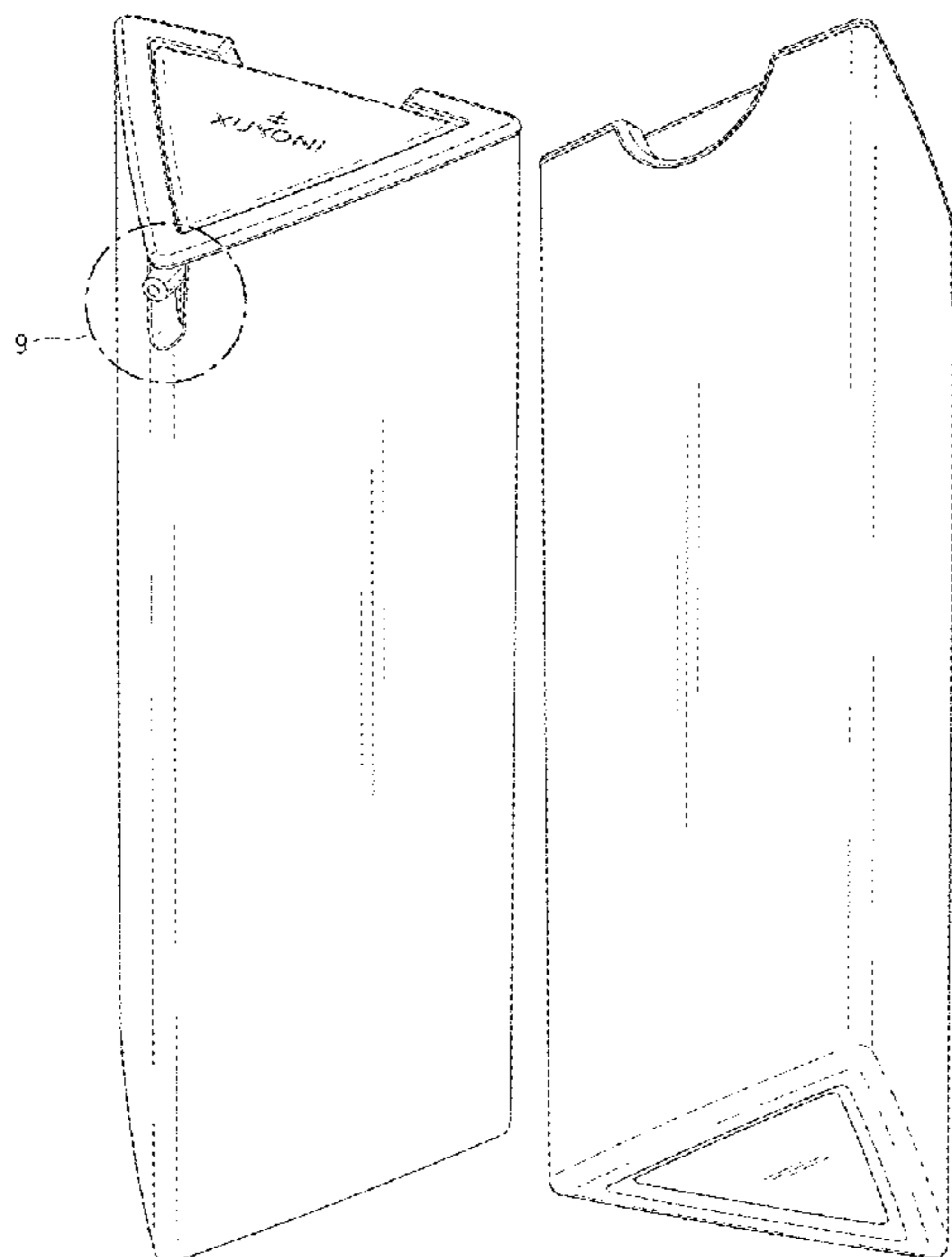

FIG. 1

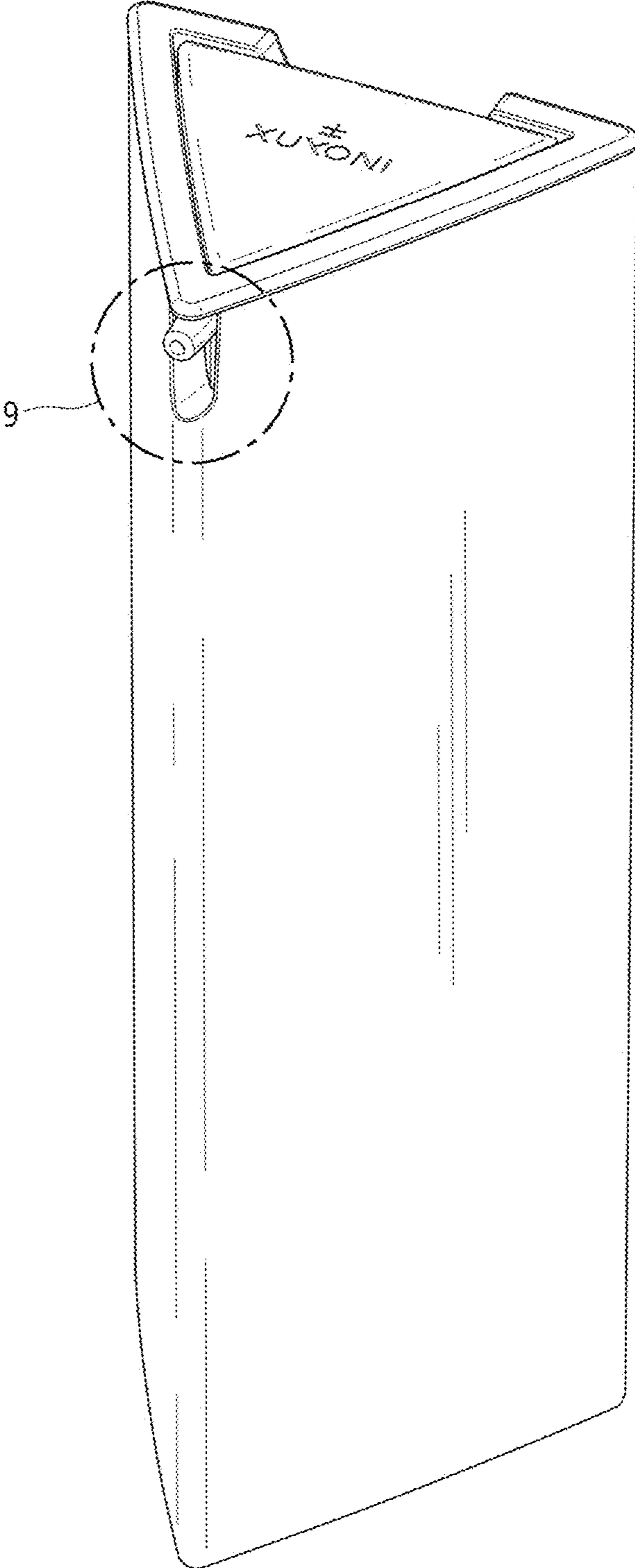

FIG. 2

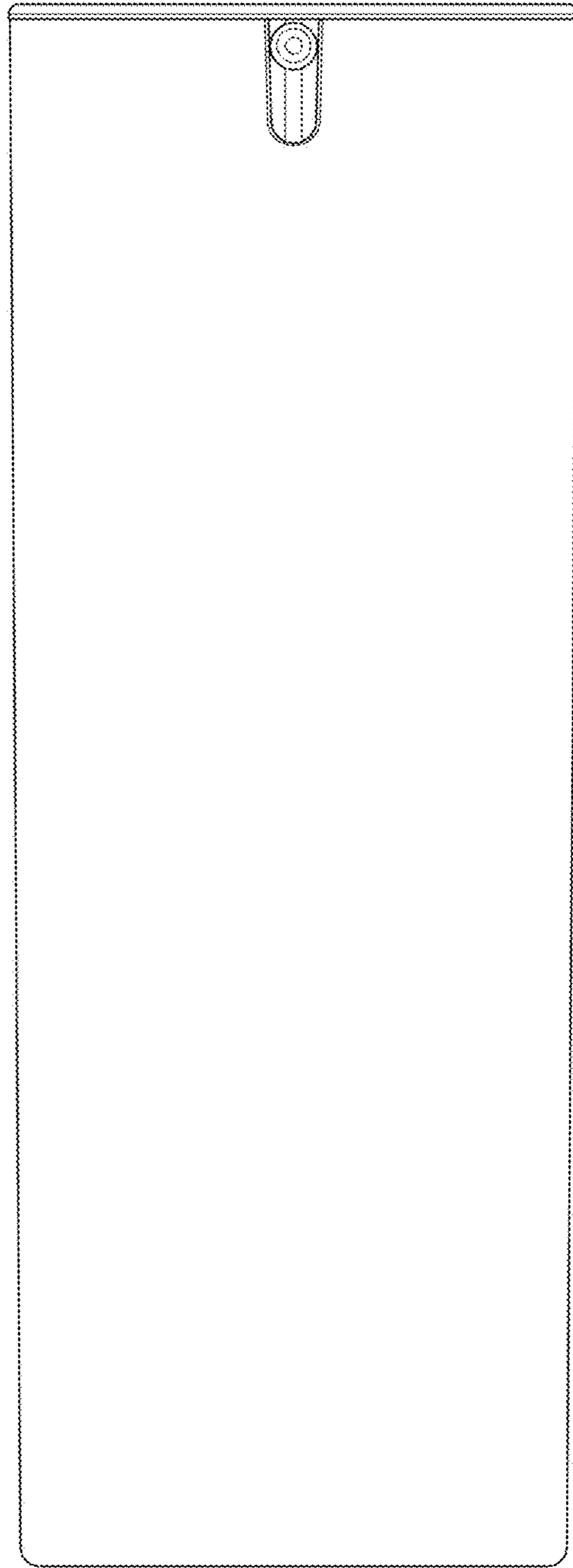

FIG. 3

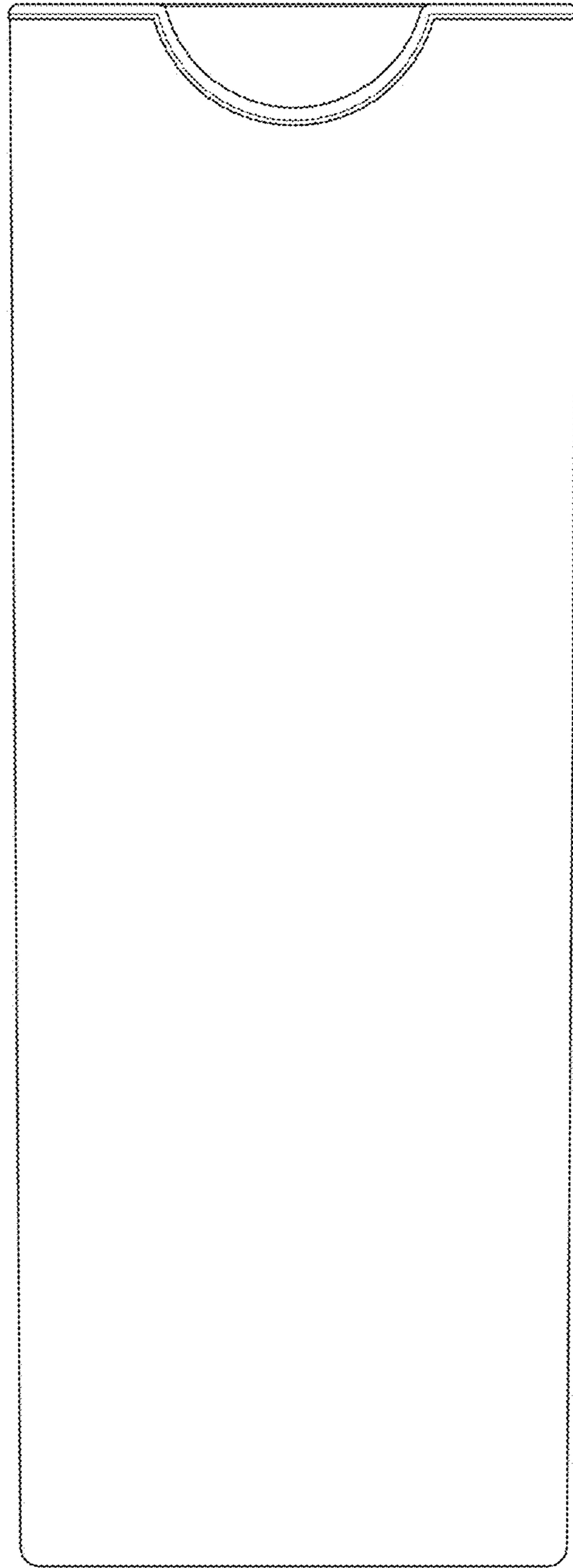

FIG. 4

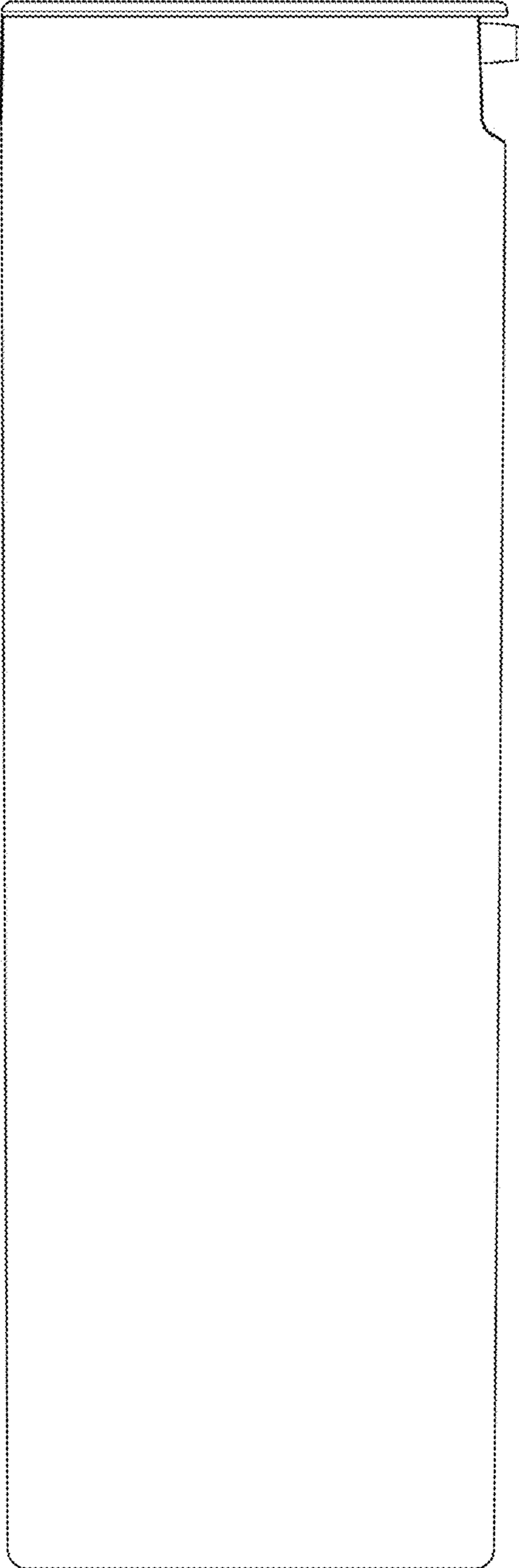

FIG. 5

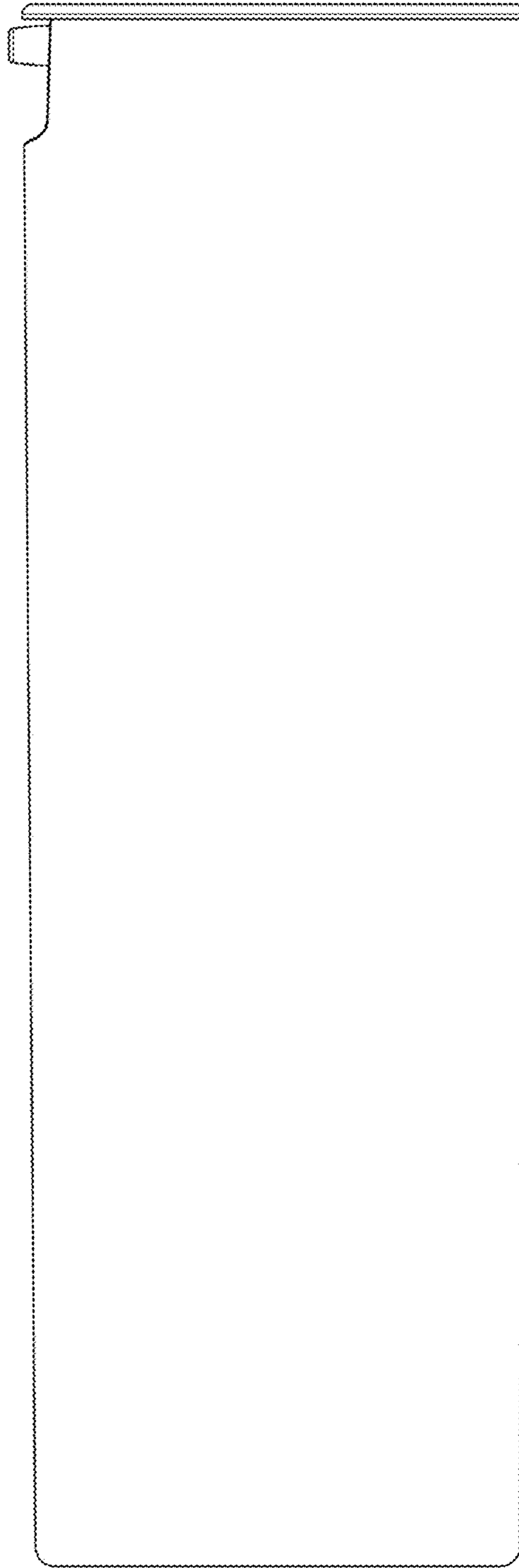

FIG. 6

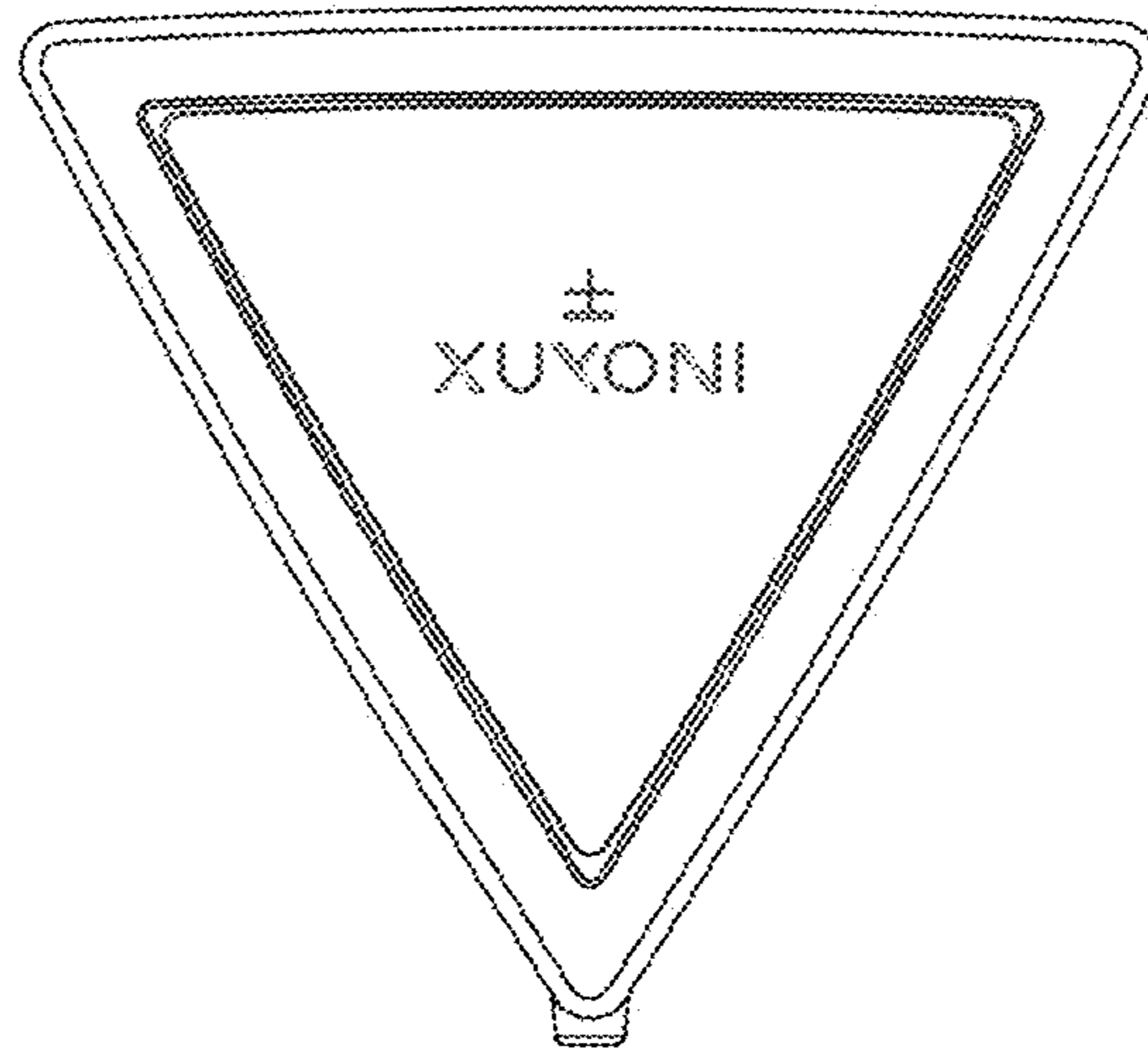

FIG. 7

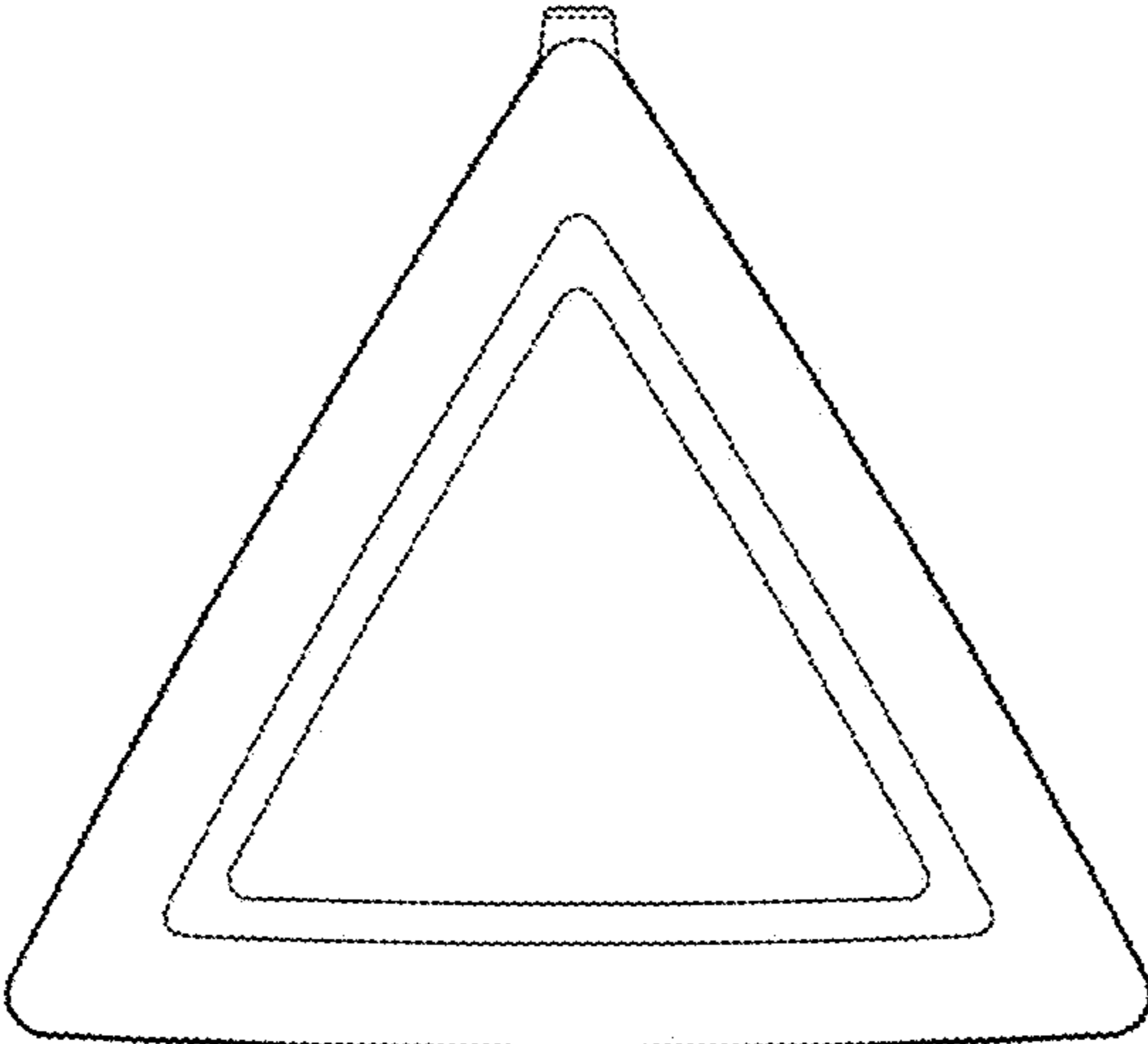



FIG. 8

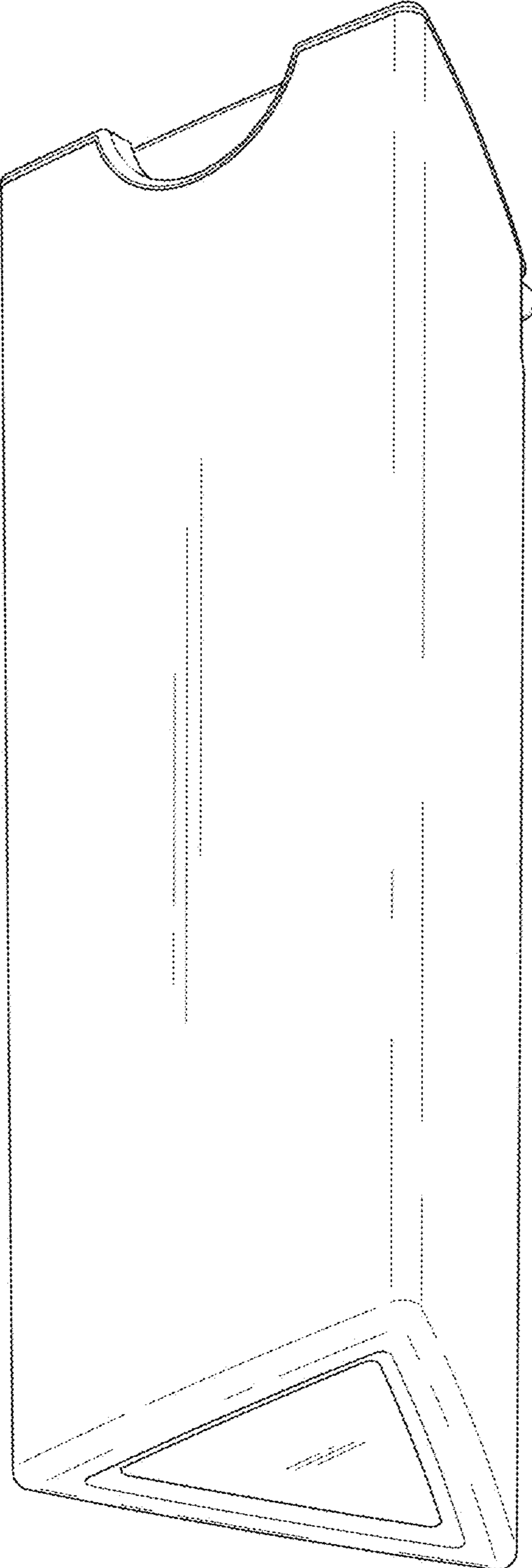

FIG. 9

