



US00D970318S

(12) **United States Design Patent**  
**Shen**

(10) **Patent No.:** **US D970,318 S**

(45) **Date of Patent:** **\*\* Nov. 22, 2022**

(54) **SNACK CONTAINER**

D395,577 S \* 6/1998 Miller ..... D7/555  
D557,047 S \* 12/2007 Dretzka ..... D3/304  
D740,132 S 10/2015 LeStage et al.

(71) Applicant: **Mengmeng Shen**, Jiangsu Province  
(CN)

(72) Inventor: **Mengmeng Shen**, Jiangsu Province  
(CN)

(\*\*) Term: **15 Years**

(21) Appl. No.: **29/864,099**

(22) Filed: **May 9, 2022**

(51) **LOC (13) Cl.** ..... **07-07**

(52) **U.S. Cl.**  
USPC ..... **D7/701; D3/313**

(58) **Field of Classification Search**  
USPC ... D7/701-708, 600.1-600.4, 590, 601, 632;  
D3/304, 313, 314; D19/77; D6/512,  
D6/524, 525; D28/73  
CPC . A47F 1/00; A47F 10/02; A47F 10/06; A47G  
23/00  
See application file for complete search history.

(56) **References Cited**

**U.S. PATENT DOCUMENTS**

D103,916 S \* 3/1937 Scurlock ..... D15/90  
D371,729 S \* 7/1996 White ..... D7/673  
D387,559 S \* 12/1997 Williamson ..... D3/313

**OTHER PUBLICATIONS**

Amazon.com, bHome 4 Adjustable Snack Organizer Bins, ASIN:  
B09VR42M57, 8 pages, date first available Mar. 16, 2022 (Year:  
2022).\*

\* cited by examiner

*Primary Examiner* — Terry A Wallace

(57) **CLAIM**

The ornamental design for a snack container, as shown and  
described.

**DESCRIPTION**

FIG. 1 is a front and top perspective view of a snack  
container, showing my new design;  
FIG. 2 is a rear and bottom perspective view thereof;  
FIG. 3 is a front elevation view thereof;  
FIG. 4 is a rear elevation view thereof;  
FIG. 5 is a left side elevation view thereof;  
FIG. 6 is a right side elevation view thereof;  
FIG. 7 is a top plan view thereof; and,  
FIG. 8 is a bottom plan view thereof.

**1 Claim, 8 Drawing Sheets**

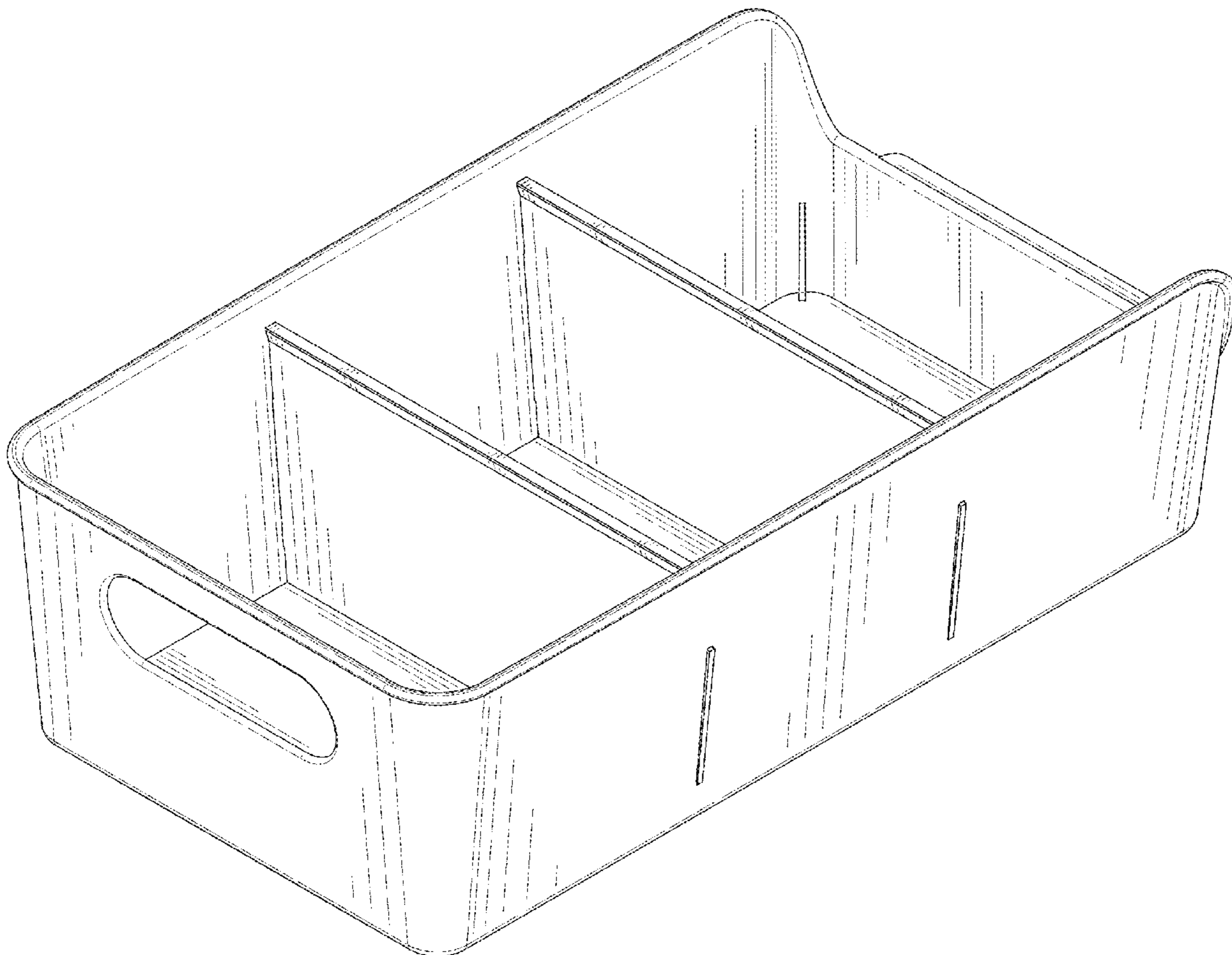

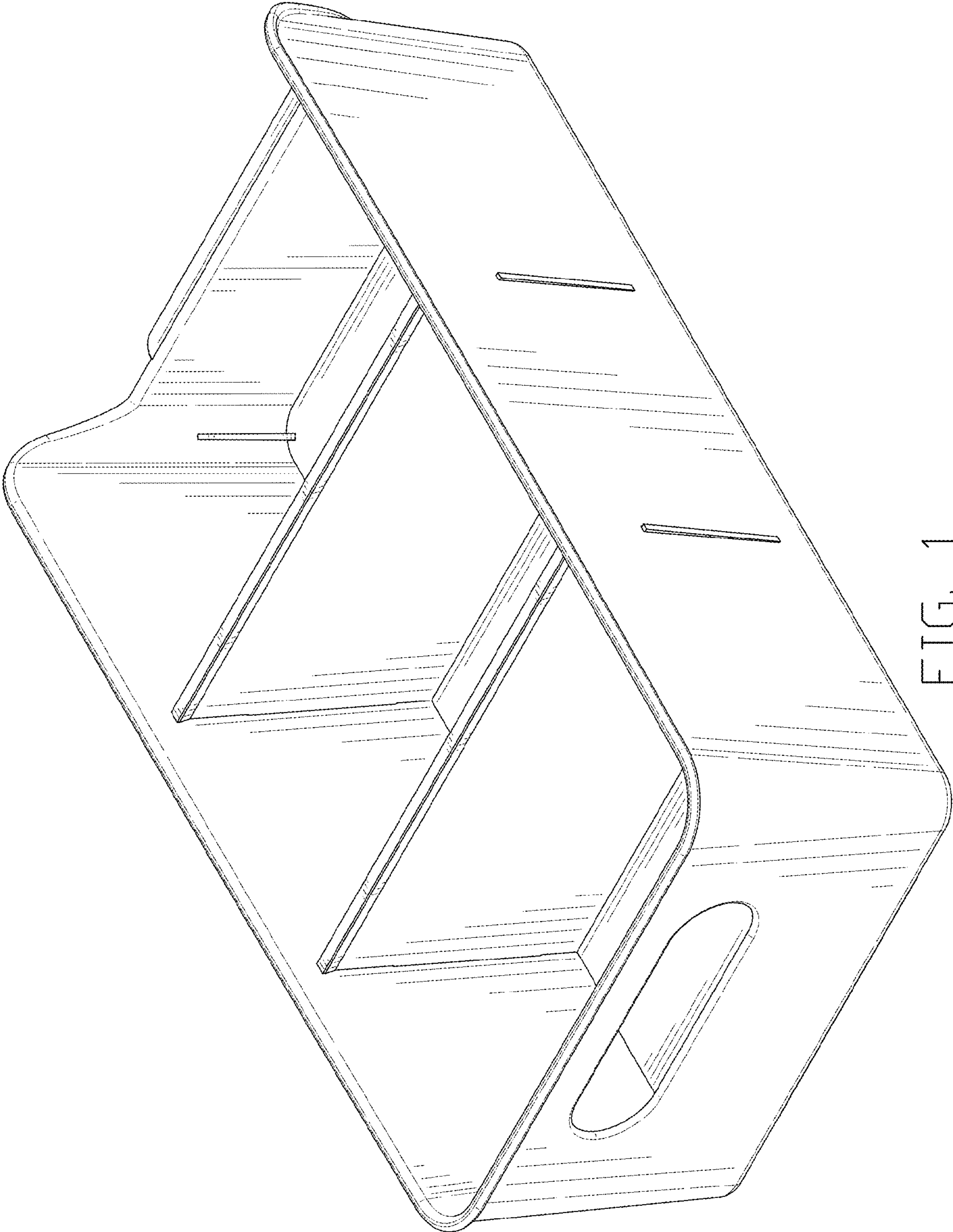

FIG. 1

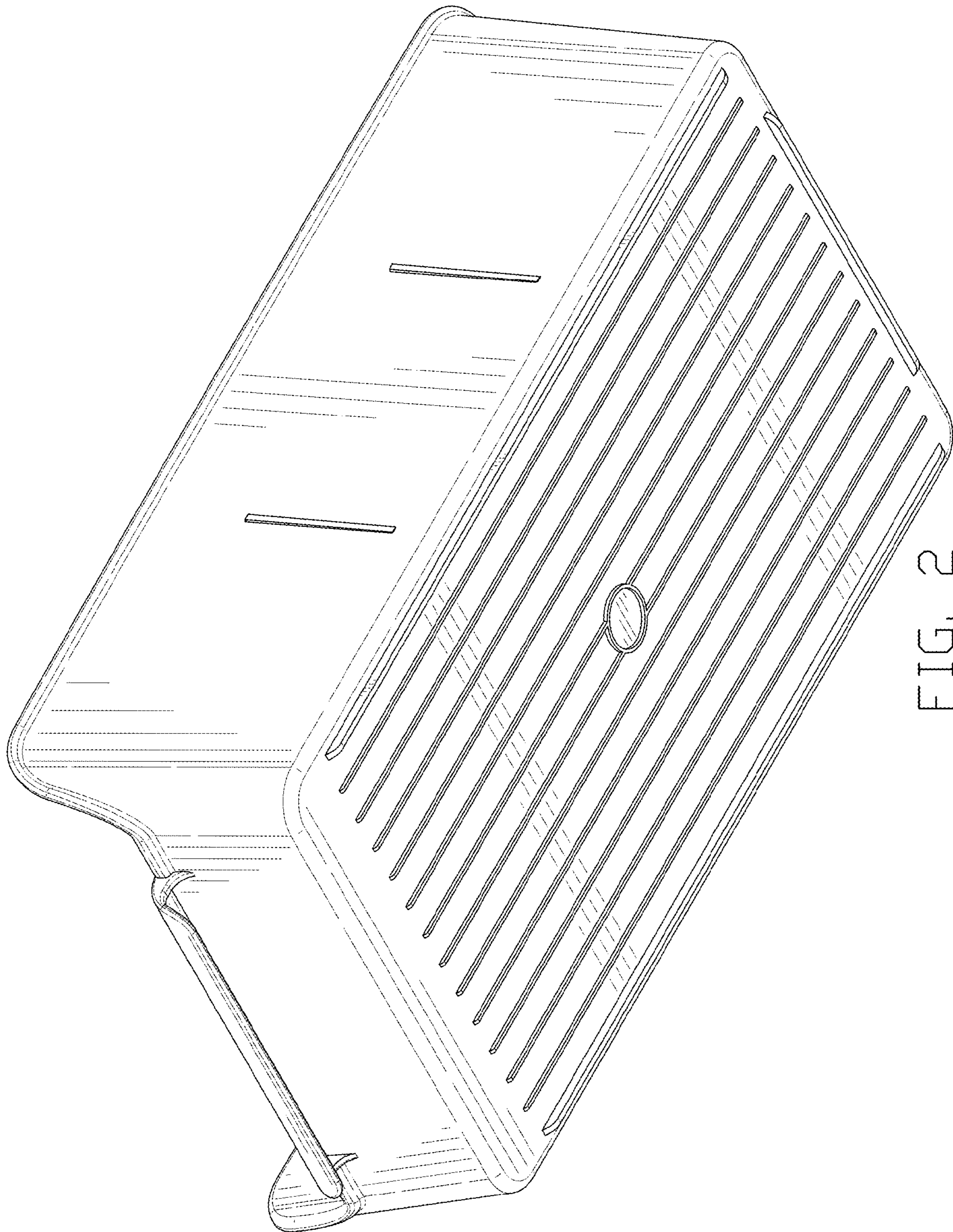

FIG. 2

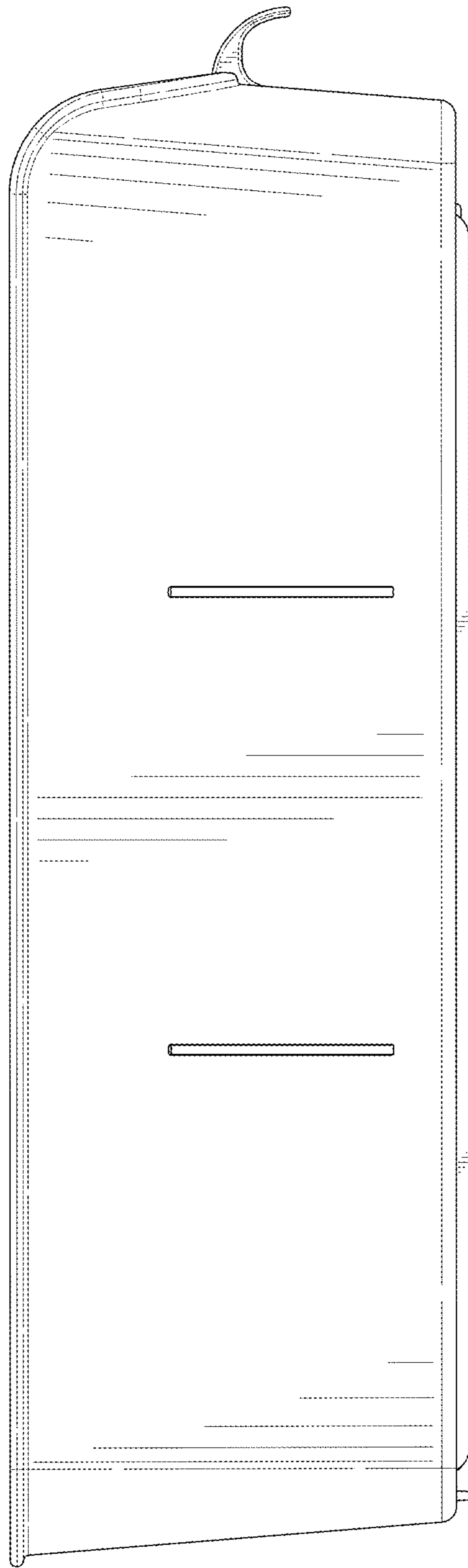

FIG. 3

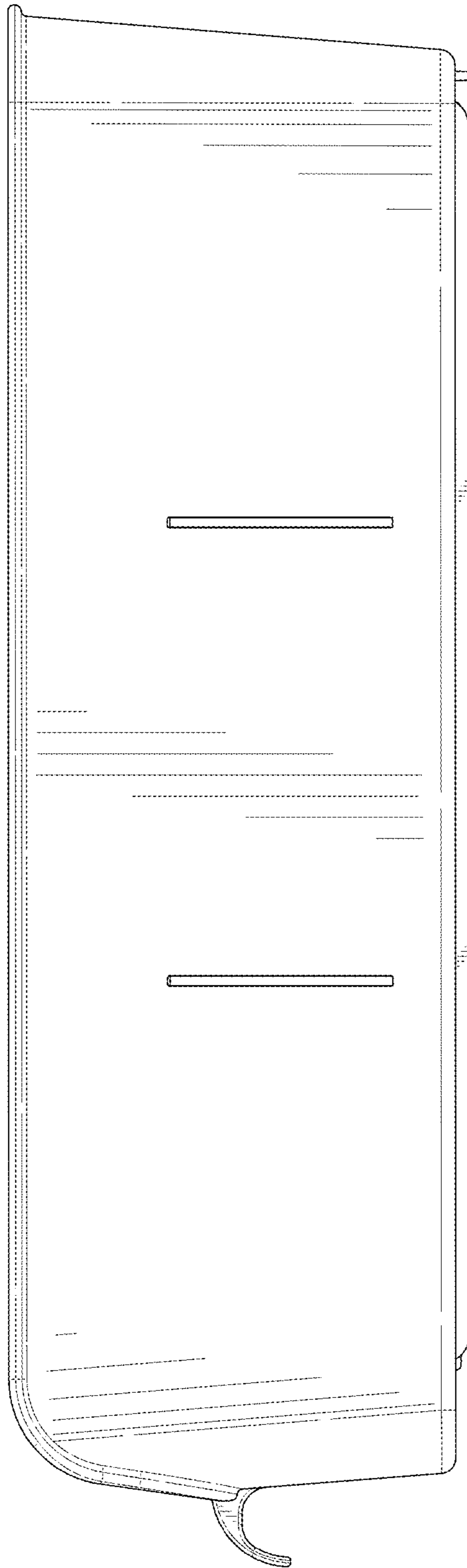

FIG. 4

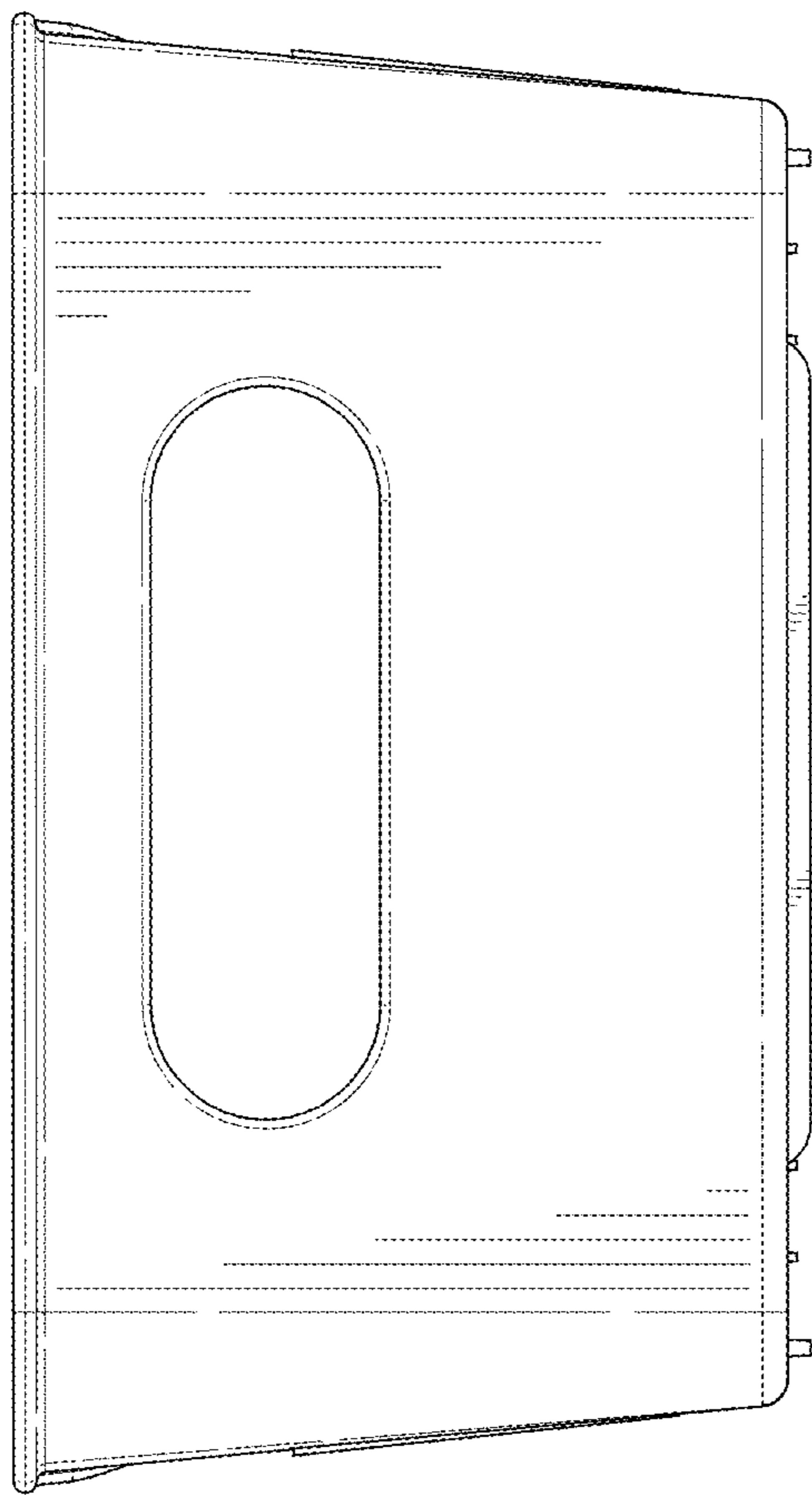

FIG. 5

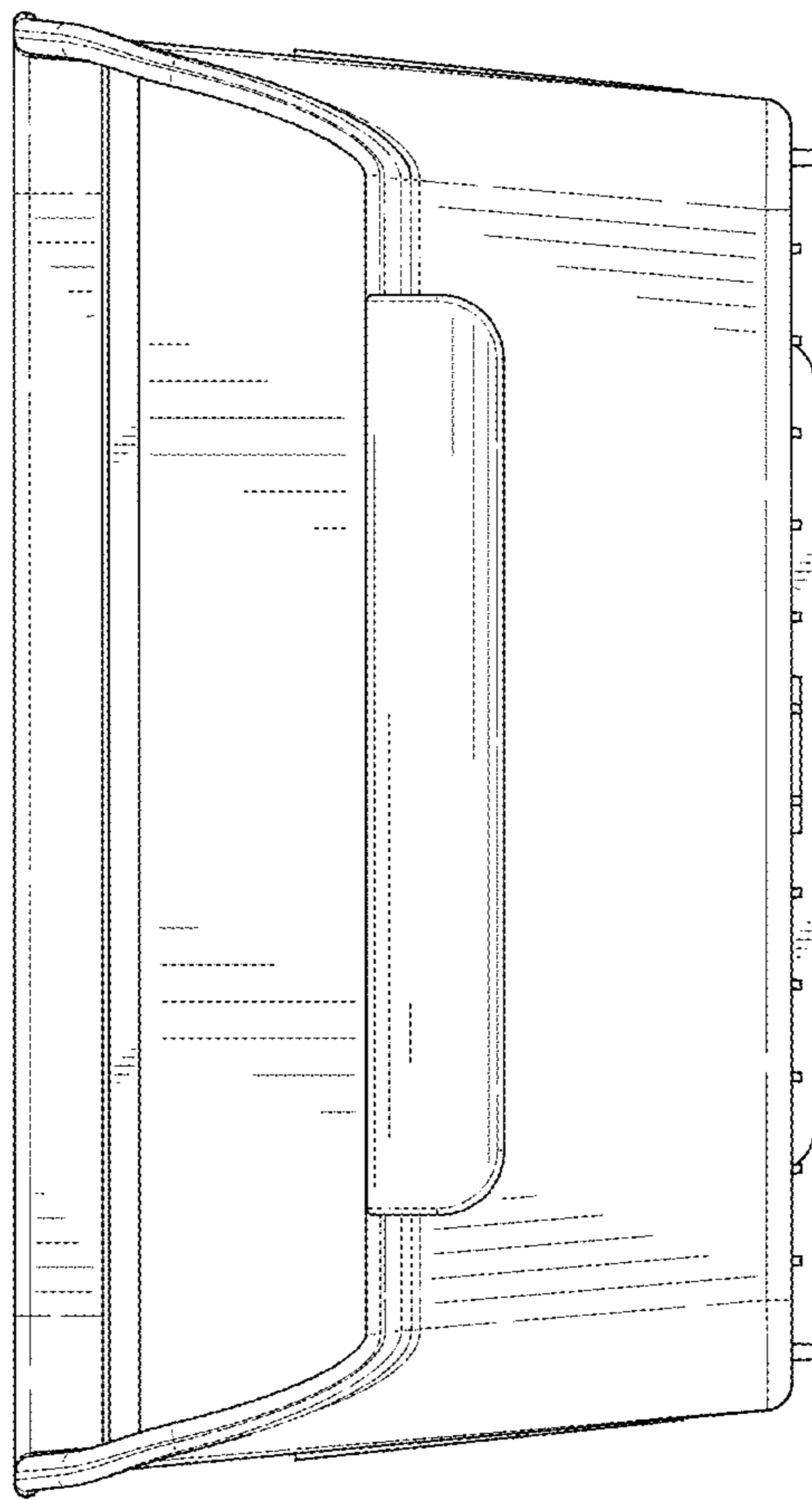

FIG. 6

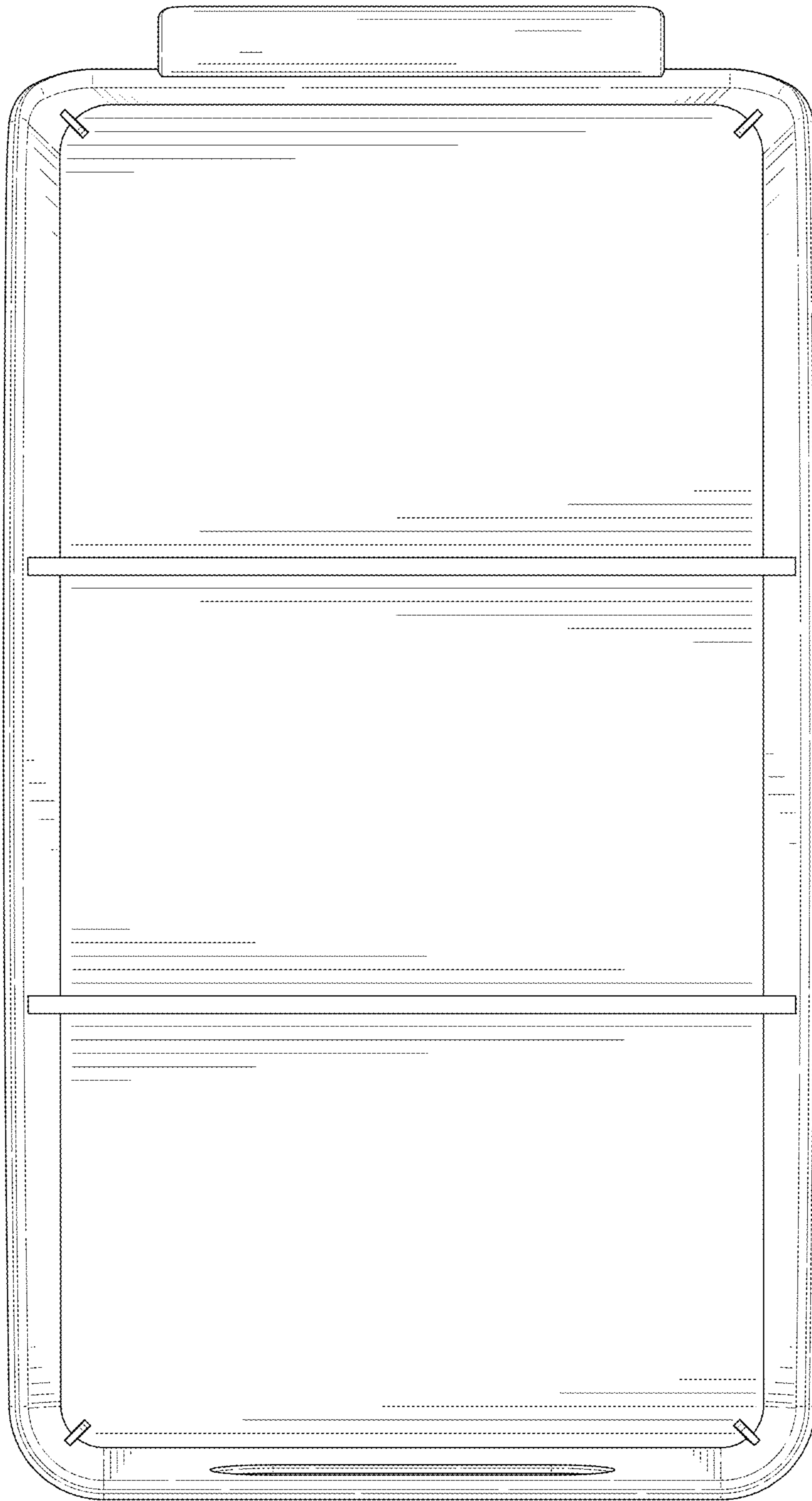

FIG. 7



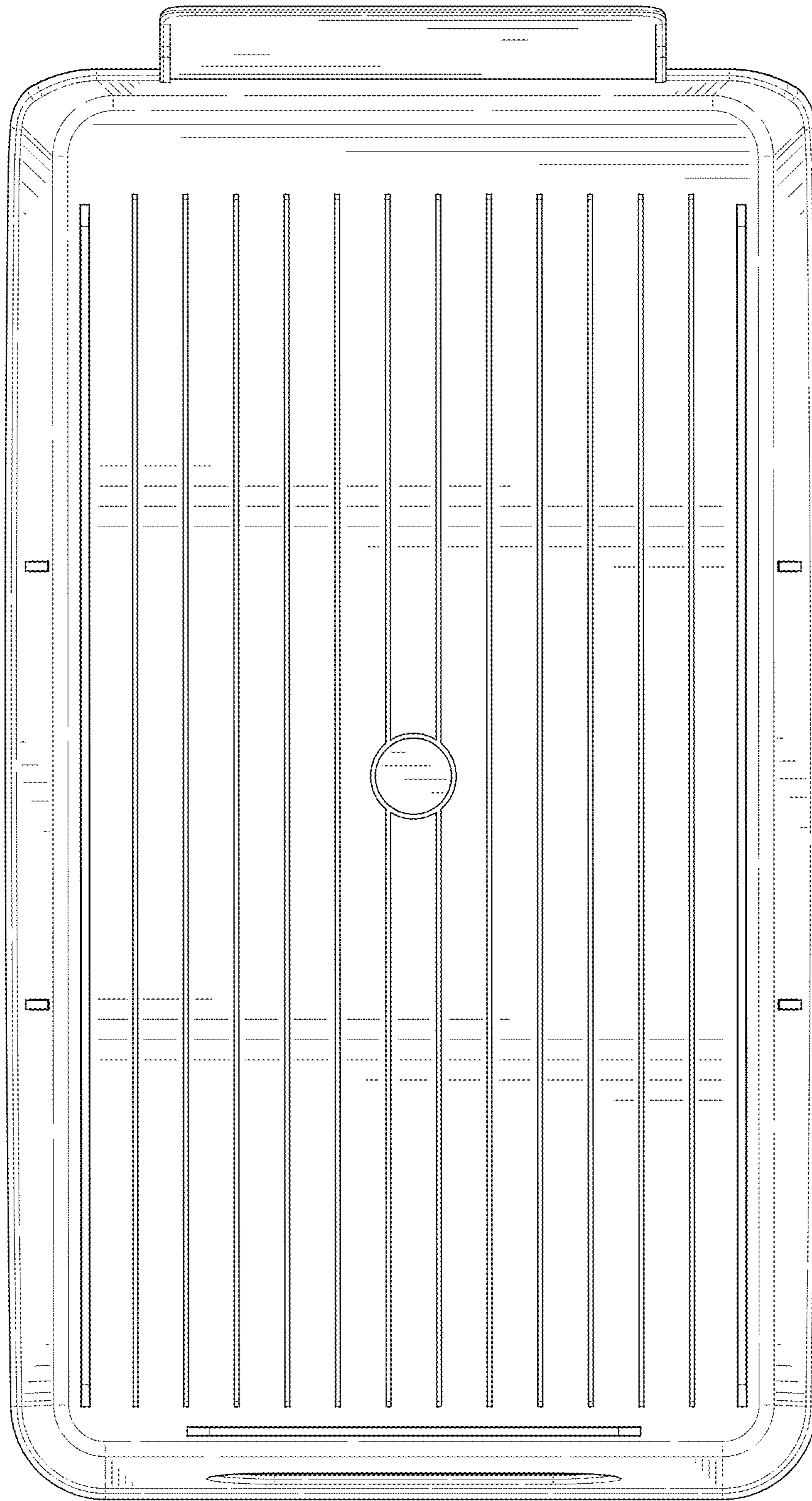

FIG. 8