



US00D970267S

(12) **United States Design Patent** (10) **Patent No.:** **US D970,267 S**
Li (45) **Date of Patent:** **** Nov. 22, 2022**

(54) **CABINET**

FOREIGN PATENT DOCUMENTS

(71) Applicant: **Luoyang Dbin Office Furniture Co., Ltd., Luoyang (CN)**

GB 2393635 A * 4/2004 A47B 47/02
KR 20100133066 A * 12/2010 A47B 67/00

(72) Inventor: **Yingbin Li, Luoyang (CN)**

OTHER PUBLICATIONS

(73) Assignee: **LUOYANG DBIN OFFICE FURNITURE CO., LTD., Luoyang (CN)**

Letaya Metal Lockers for Employees, 71" Steel Storage Cabinet with 4 Door Lockable for Office Staff, Home Sundries, Gym, School (Gray&White), amazon.com, Date First Available: May 9, 2022, pp. 1-9, from https://www.amazon.com/Letaya-Lockers-Employees-Lockable-Sundries/dp/B09ZV27GN7/ref=sr_1_2?crd=1JQNVOR7FTSYQ&keywords=Metal%2BLocker%2BSteel%2BStorage%2BCabinet%2Bwith%2B4%2BDoors%2Bfor%2BOffice%2BEmployees%2BSchool%2BGym&qid=1663730921&srefix=metal%2BLocker%2Bsteel%2Bstorage%2Bcabinet%2Bwith%2B4%2Bdoors%2Bfor%2Boffice%2BEmployees%2BSchool%2Bgym%2Caps%2C91&sr=8-2&th=1 (Year: 2022).*

(**) Term: **15 Years**

(21) Appl. No.: **29/824,520**

(22) Filed: **Jan. 25, 2022**

(51) **LOC (13) Cl.** **06-04**

(52) **U.S. Cl.**

USPC **D6/671**

(58) **Field of Classification Search**

USPC D6/663, 664, 671, 671.1, 671.2, 671.3, D6/671.4, 661, 665

CPC A47B 47/00; A47B 17/04; A47B 45/00; A47B 47/03; A47B 47/04; A47B 63/00; A47B 67/00; A47B 67/04; A47B 47/02; A47B 61/00; A47B 81/00

See application file for complete search history.

* cited by examiner

Primary Examiner — Mimoso De
(74) *Attorney, Agent, or Firm* — Chun-Ming Shih; Lanway IPR Services

(57) **CLAIM**

The ornamental design for a cabinet, as shown and described.

DESCRIPTION

(56) **References Cited**

U.S. PATENT DOCUMENTS

D361,446 S * 8/1995 Acard D6/671
D441,985 S * 5/2001 Melillo D6/671.1
D441,986 S * 5/2001 Melillo D6/671.1
D446,407 S * 8/2001 Melillo D6/671.1
D613,973 S 4/2010 Holcomb
D632,506 S 2/2011 Perc
D634,945 S 3/2011 Perc
D646,080 S 10/2011 Clegg et al.
D668,078 S 10/2012 Daino et al.
D670,510 S 11/2012 Daino et al.
D704,966 S 5/2014 Korb
D864,623 S 10/2019 Vandenharn et al.
D904,081 S 12/2020 Hermann et al.

FIG. 1 is a perspective view of a cabinet showing the new design;

FIG. 2 is a front view thereof;

FIG. 3 is a back view thereof;

FIG. 4 is a left side view thereof;

FIG. 5 is a right side view thereof;

FIG. 6 is a top view thereof;

FIG. 7 is a bottom view thereof; and,

FIG. 8 is an enlarged view of FIG. 1 thereof.

The broken lines shown in the drawing are for the purpose of illustrating environmental structure and form no part of the claimed design.

1 Claim, 8 Drawing Sheets

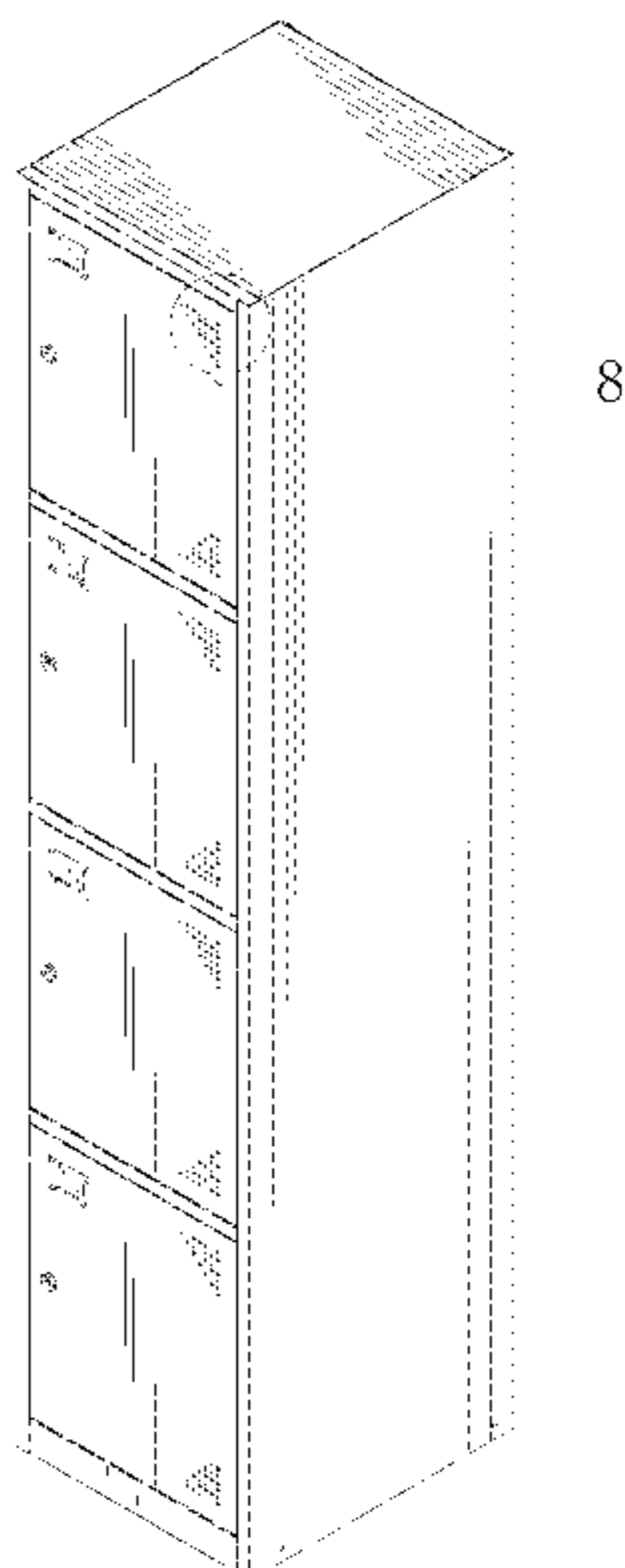

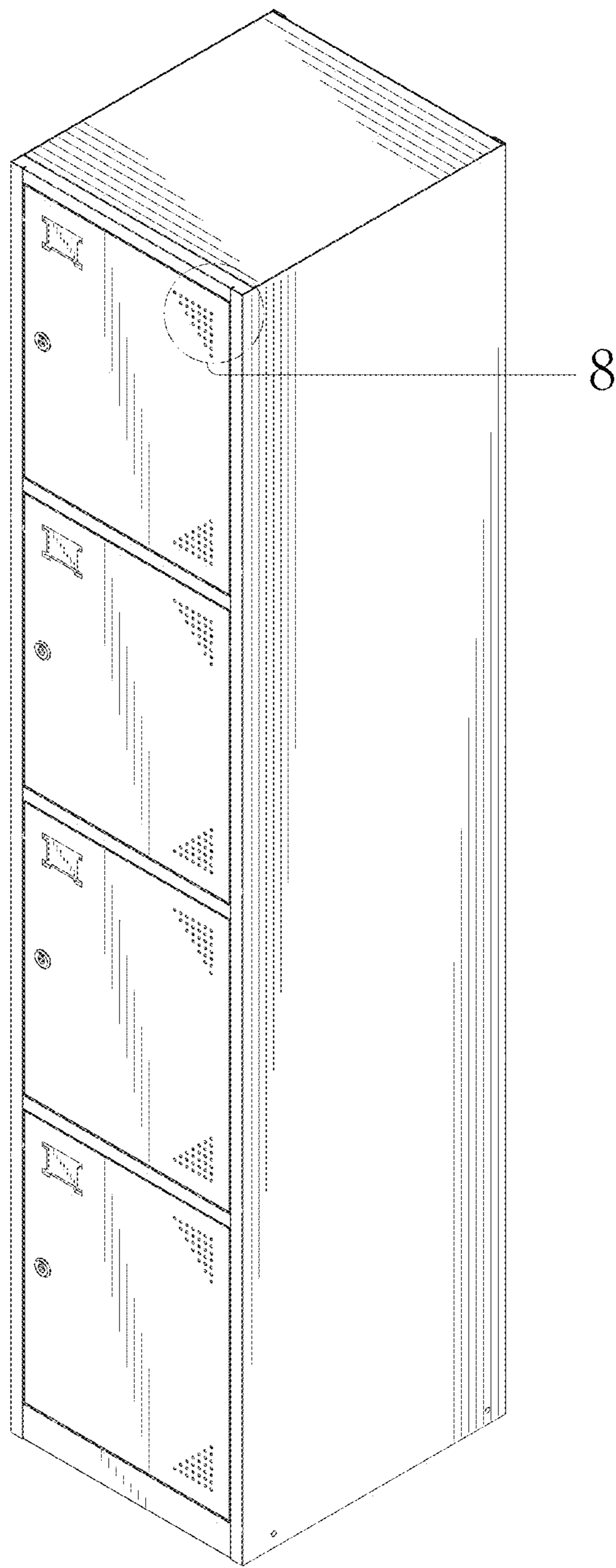

FIG. 1

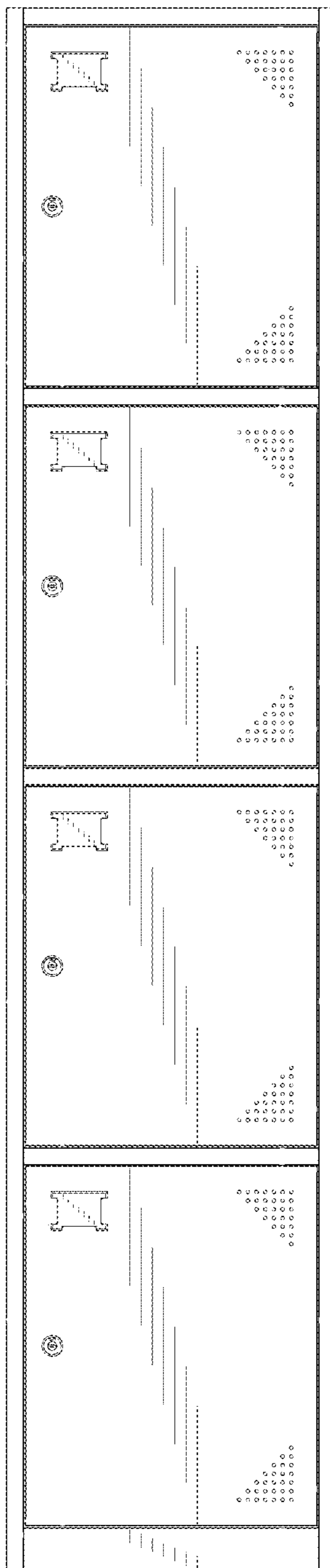

FIG. 2

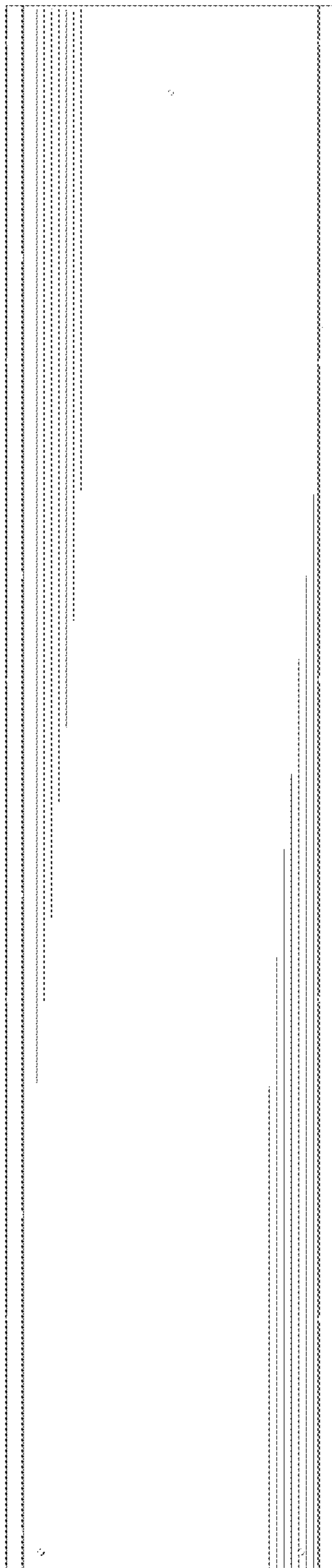

FIG. 3

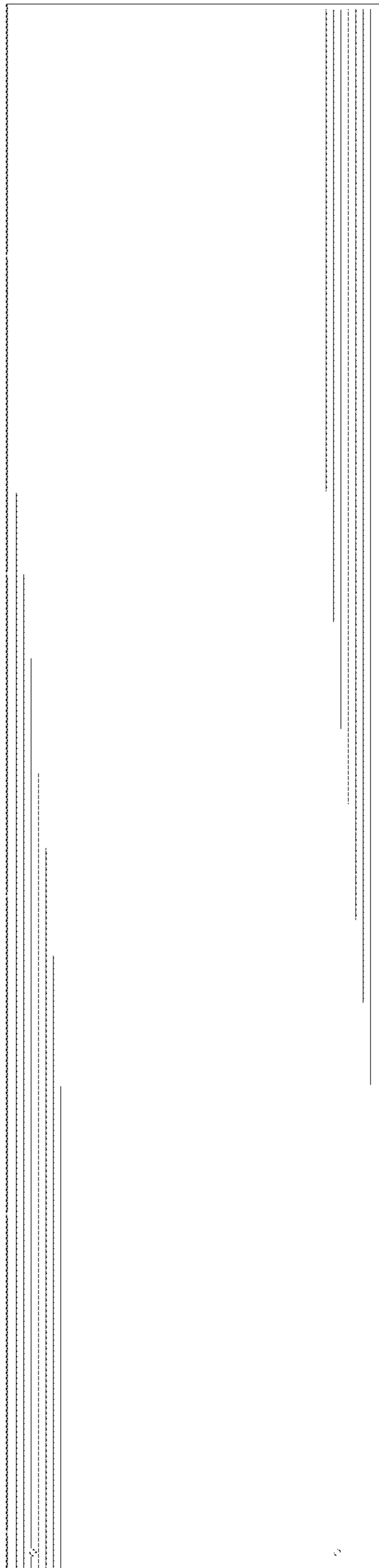

FIG. 4

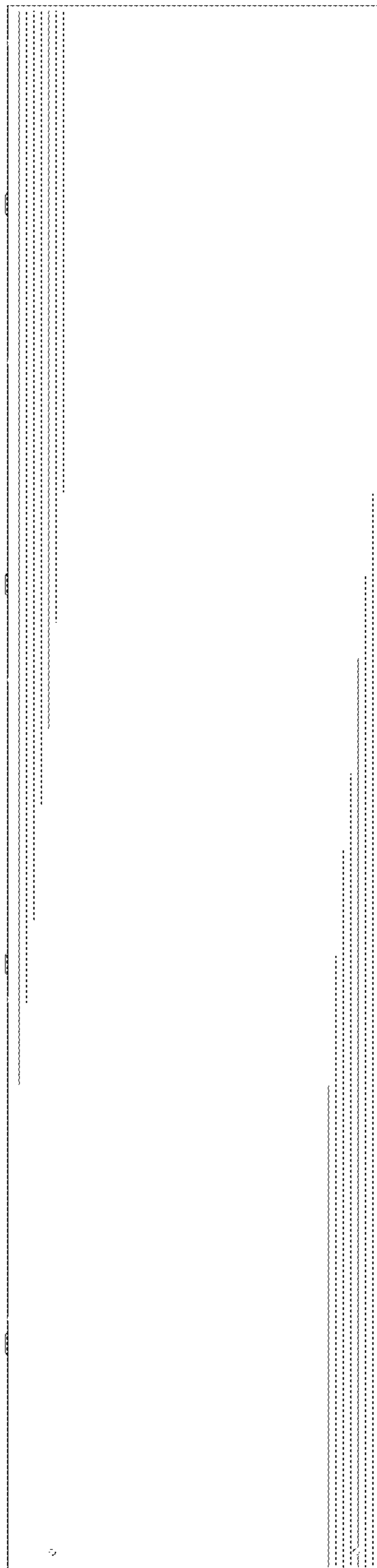

FIG. 5

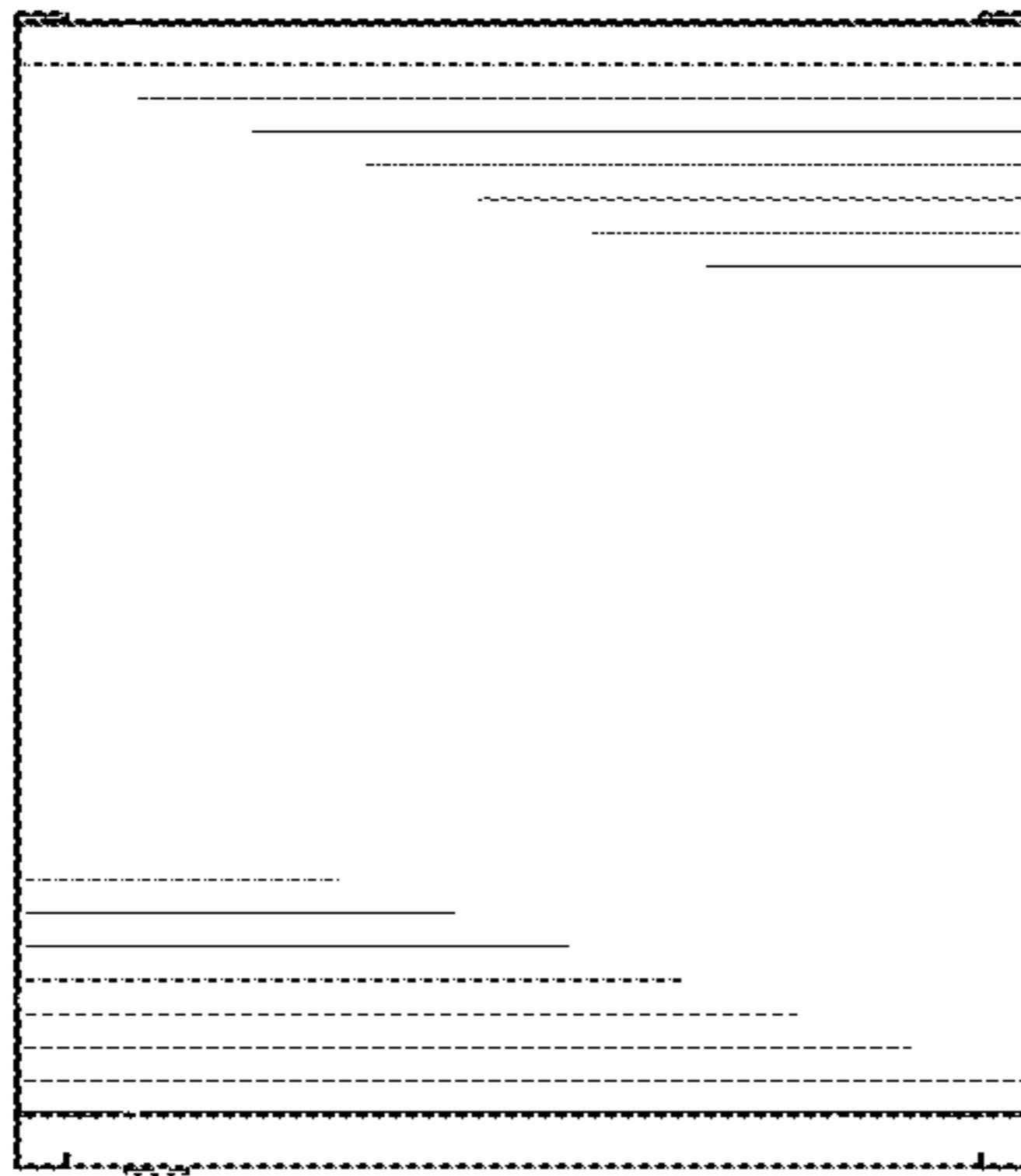

FIG. 6

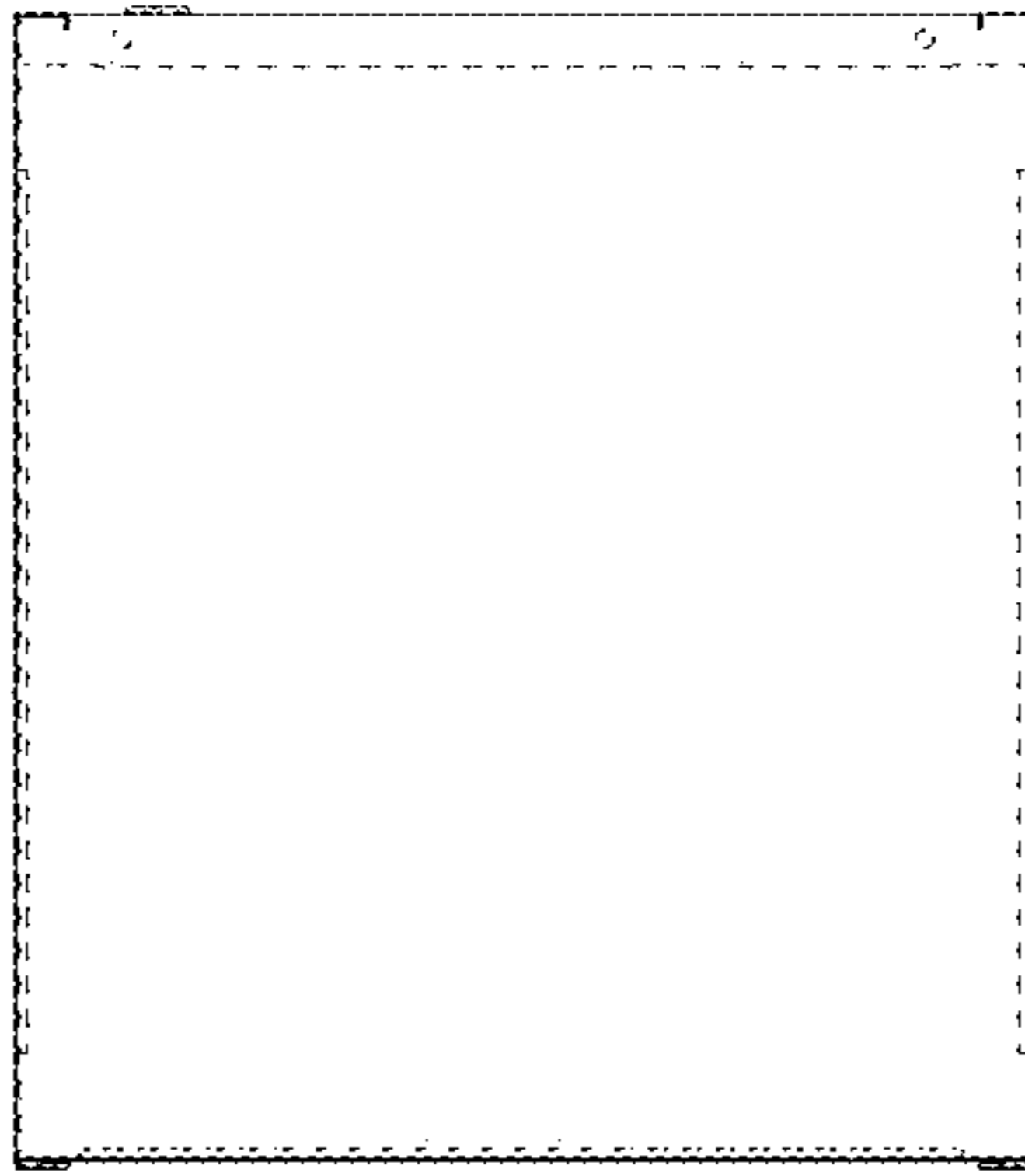

FIG. 7

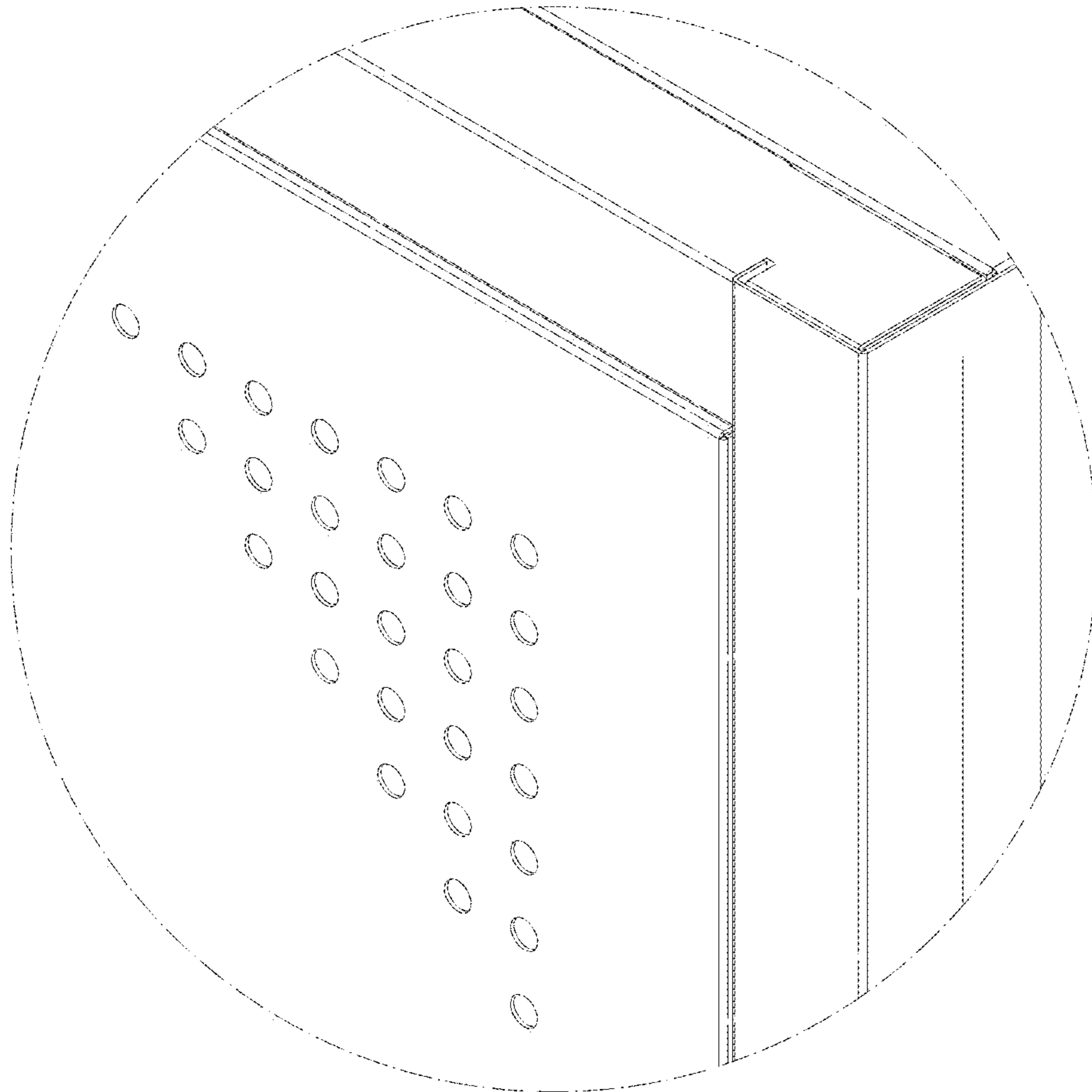

FIG. 8