



US00D970260S

(12) **United States Design Patent** (10) **Patent No.:** **US D970,260 S**
Hu (45) **Date of Patent:** **** Nov. 22, 2022**

(54) **PILLOW**
(71) Applicant: **Yaowei Hu**, Guangdong (CN)
(72) Inventor: **Yaowei Hu**, Guangdong (CN)

6,052,848 A * 4/2000 Kelly A47C 20/021
5/640
D431,745 S * 10/2000 Jackson D6/601
D450,517 S * 11/2001 Darling D6/601
(Continued)

(**) Term: **15 Years**

FOREIGN PATENT DOCUMENTS

(21) Appl. No.: **29/809,830**

CN 305482847 * 12/2019
GB 6146914 * 7/2021
GB 6180984 * 12/2021

(22) Filed: **Sep. 30, 2021**

(51) **LOC (13) Cl.** **06-09**

(52) **U.S. Cl.**
USPC **D6/601**

(58) **Field of Classification Search**
USPC D6/595, 596, 597, 600, 601, 603, 604,
D6/605, 606, 608; D24/183, 185, 234;
D21/803, 804, 805, 809
CPC A47G 2009/1018; A47G 2009/003; A47G
9/0253; A47G 9/10; A47G 9/1027; A47G
9/1036; A47G 9/1054; A47G 9/1063;
A47G 9/1072; A47G 9/1081; A47G
9/109; A45F 4/06; A47C 21/06; A47C
7/18; A47C 20/00; A47C 17/80; A47C
17/82; A47C 17/64; A47C 27/00; A47C
27/14; A47C 23/00

See application file for complete search history.

OTHER PUBLICATIONS

Awesling 60in Full Body Pregnancy Pillow, earliest pictured review Dec. 30, 2019, [online], [site visited Aug. 26, 2021]. Available from Internet, <URL: https://www.amazon.com/Awesling-Maternity-Pregnancy-Detachable-Removable/dp/B07PLF1J63/ref=sr_1_14?crd=1UBUCDLLAMJAP&dchild=1&keywords=pregnancy+pillows&qid=1614197435&srefix=preg%2Caps%2C199&sr=8-14> (Year: 2019).*

(Continued)

Primary Examiner — Sanjeev Paul
(74) *Attorney, Agent, or Firm* — True Shepherd, LLC;
Andrew Cheng

(57) **CLAIM**

The ornamental design for a pillow, as shown and described.

DESCRIPTION

FIG. 1 is a front, left and top perspective view of a pillow, showing my design.
FIG. 2 is a front elevation view thereof.
FIG. 3 is a rear elevation view thereof.
FIG. 4 is a left side elevation view thereof.
FIG. 5 is a right side elevation view thereof.
FIG. 6 is a top plan view thereof; and,
FIG. 7 is a bottom plan view thereof.
The broken lines shown in the drawings are included for the purpose of illustrating portions of the pillow that form no part of the claimed design.

(56) **References Cited**

U.S. PATENT DOCUMENTS

D201,492 S * 6/1965 Jacobson D6/601
D216,525 S * 2/1970 Meinwieser D6/604
D218,888 S * 10/1970 Blank D6/601
D242,388 S * 11/1976 Castelberry 5/636
5,269,323 A * 12/1993 Krouskop A47C 20/021
5/632
5,519,906 A * 5/1996 Fanto-Chan A47D 13/083
5/636
D382,435 S * 8/1997 Schaffner D6/601
D416,159 S * 11/1999 Porter D6/333
5,987,674 A * 11/1999 Schaffner A47C 20/023
5/652

1 Claim, 7 Drawing Sheets

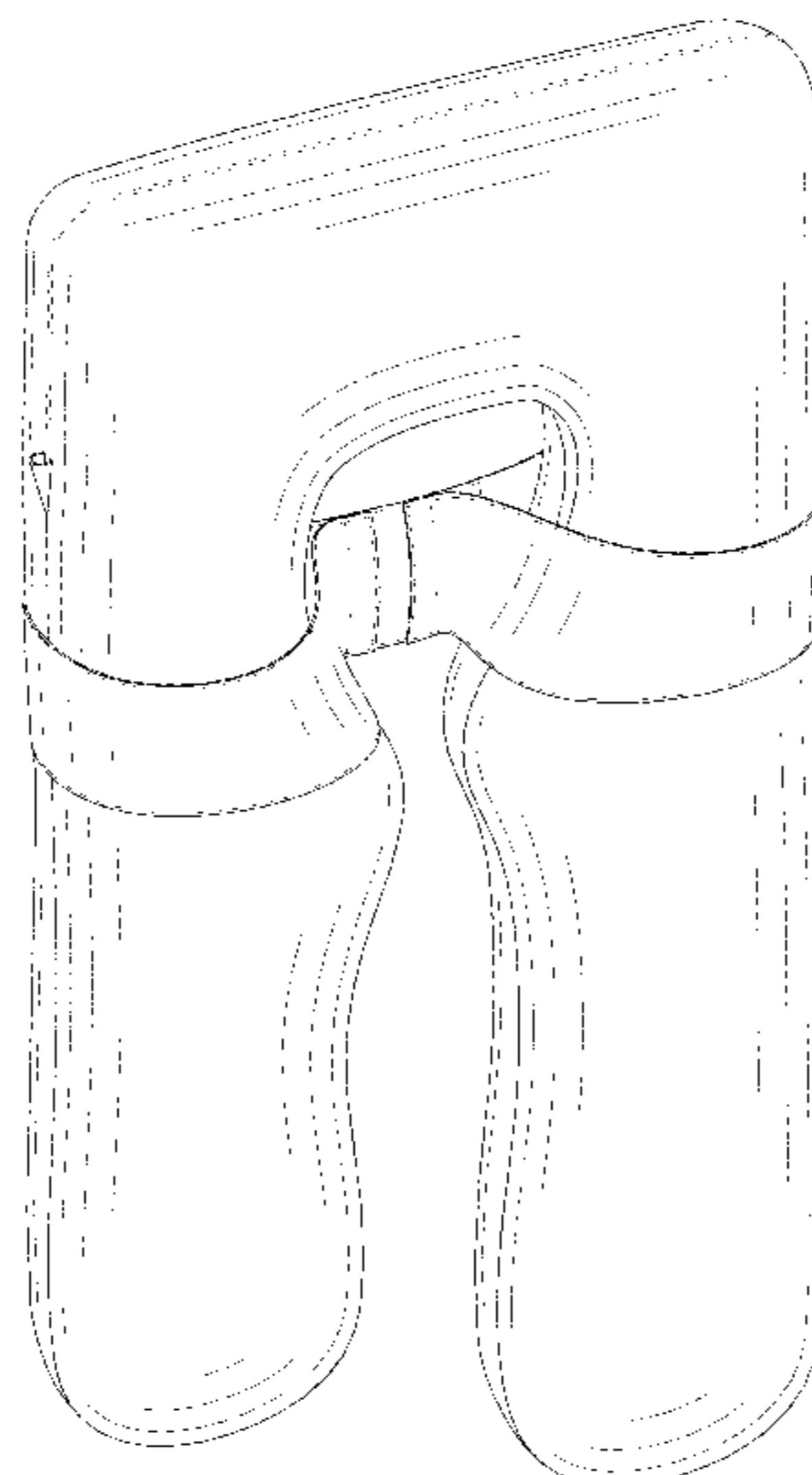

(56)

References Cited

U.S. PATENT DOCUMENTS

D453,653 S * 2/2002 Tunnell A47C 20/027
 D6/601
 6,499,164 B1 * 12/2002 Leach A47C 20/023
 5/652
 6,751,817 B1 * 6/2004 Leach A47D 13/083
 5/652
 7,114,206 B2 * 10/2006 Leach A47C 20/021
 5/652
 7,513,001 B1 * 4/2009 Leach A47G 9/1045
 5/655
 7,793,371 B1 * 9/2010 Leach A47C 20/025
 5/655
 D663,150 S * 7/2012 Oberpriller D6/601
 D666,861 S * 9/2012 Phillips D6/601
 9,021,635 B1 * 5/2015 Leach A47C 20/02
 5/632
 D736,011 S * 8/2015 Fresonke D6/601
 D768,409 S * 10/2016 Park D6/601
 D769,649 S * 10/2016 Vargas D6/601
 D830,733 S * 10/2018 Mi D6/601
 D850,817 S * 6/2019 Tong D6/601
 10,736,444 B1 * 8/2020 Leach A47G 9/0253
 D898,431 S * 10/2020 Huang D6/601
 D906,013 S * 12/2020 Chunyu D6/601
 D908,395 S * 1/2021 David D6/601
 D914,398 S * 3/2021 Gao D6/601
 D923,971 S * 7/2021 Qiu D6/601
 D930,395 S 9/2021 Noyberg

D930,402 S 9/2021 Ma
 D944,564 S * 3/2022 Qiu D6/601
 D946,310 S * 3/2022 Xu D6/601
 2005/0066443 A1 * 3/2005 Rivera-Wienhold
 A47D 13/08
 5/655
 2015/0173524 A1 * 6/2015 McQuilton A47D 15/00
 5/652

OTHER PUBLICATIONS

CDEN Pregnancy Pillow, earliest date available unknown, [online],
 [site visited Feb. 24, 2021]. Available from Internet, <URL: <https://www.amazon.com/CDEN-Pregnancy-Maternity-Pregnant-Removable/dp/B08MCL55FY?th=1>> (Year: 2021).*

Google Term Search: 'Pregnancy Pillow', [site visited Aug. 26, 2022] <URL: https://www.google.com/search?q=pregnancy+pillow&sxsrf=ALiCzsZsj9rowsXdp1VT-wXwXrfAqwWg8A:1661647034815&source=lnms&tbm=isch&sa=X&ved=2ahUKEwif7IHKpej5AhWJGIkFHYKLCFcQ_AUoAnoECAEQBA&biw=1920&bih=880&dpr=1> (Year: 2022).*

Google Term Search: 'Body Pillow', [site visited Aug. 26, 2022] <URL: https://www.google.com/search?q=body+pillow&sxsrf=ALiCzsZnjeqBhsvq4uS8kPMLLpyEnsiFiA:1661647017657&source=lnms&tbm=isch&sa=X&ved=2ahUKEwjX1OrBpej5AhUnM1kFHSLFBdsQ_AUoAnoECAEQBA&biw=1920&bih=880&dpr=1> (Year: 2022).*

* cited by examiner

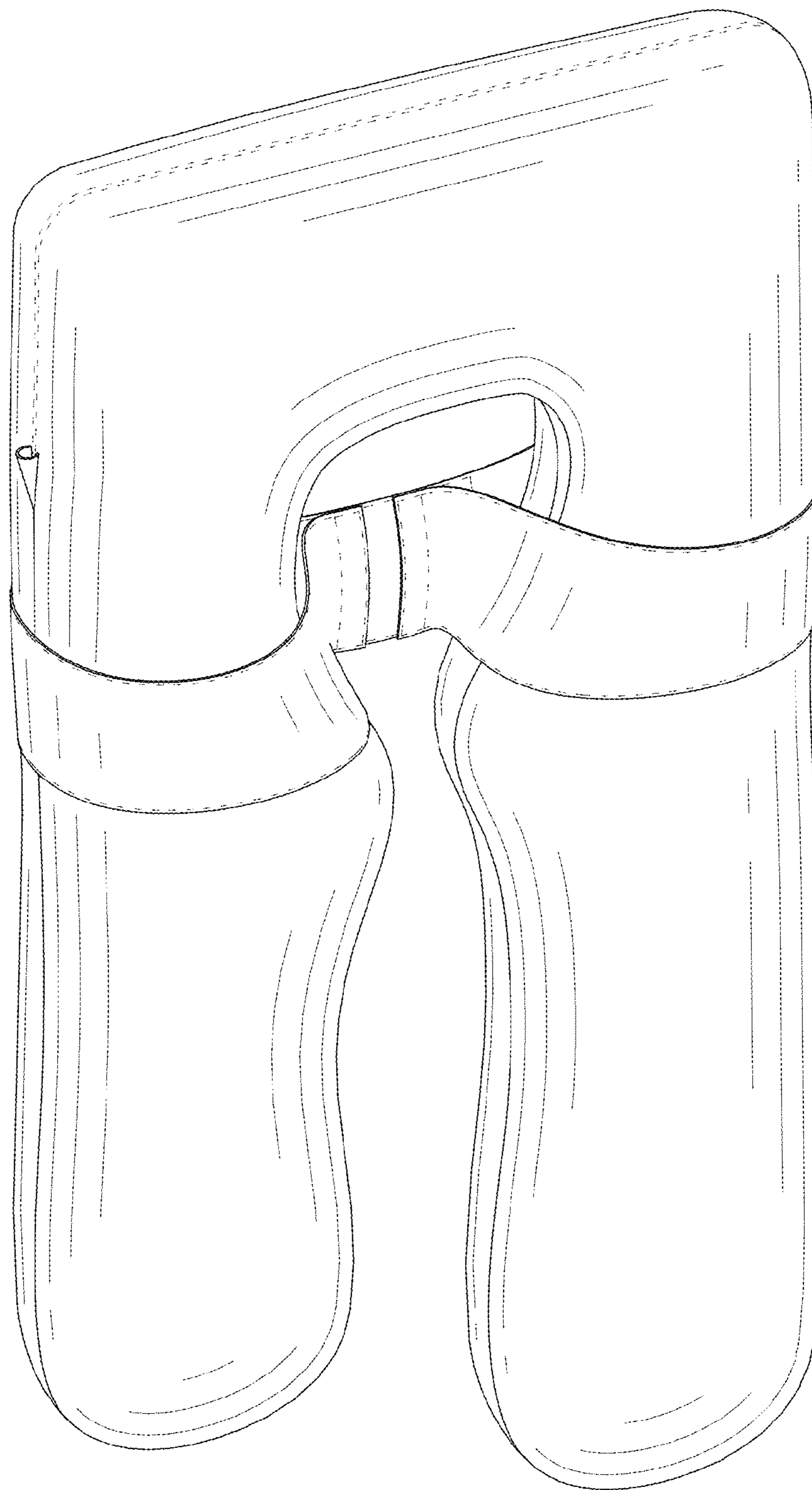

FIG. 1

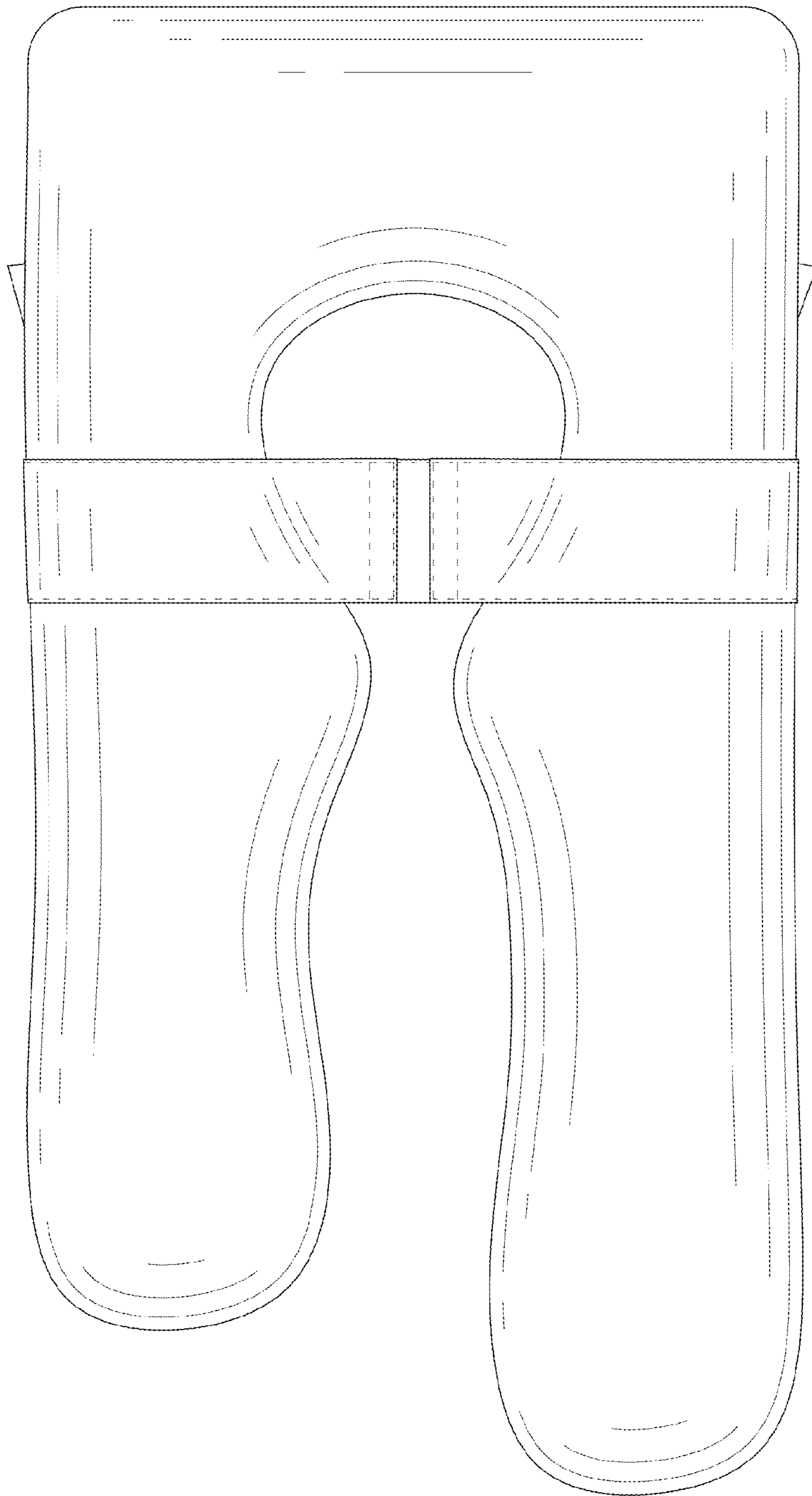

FIG. 2

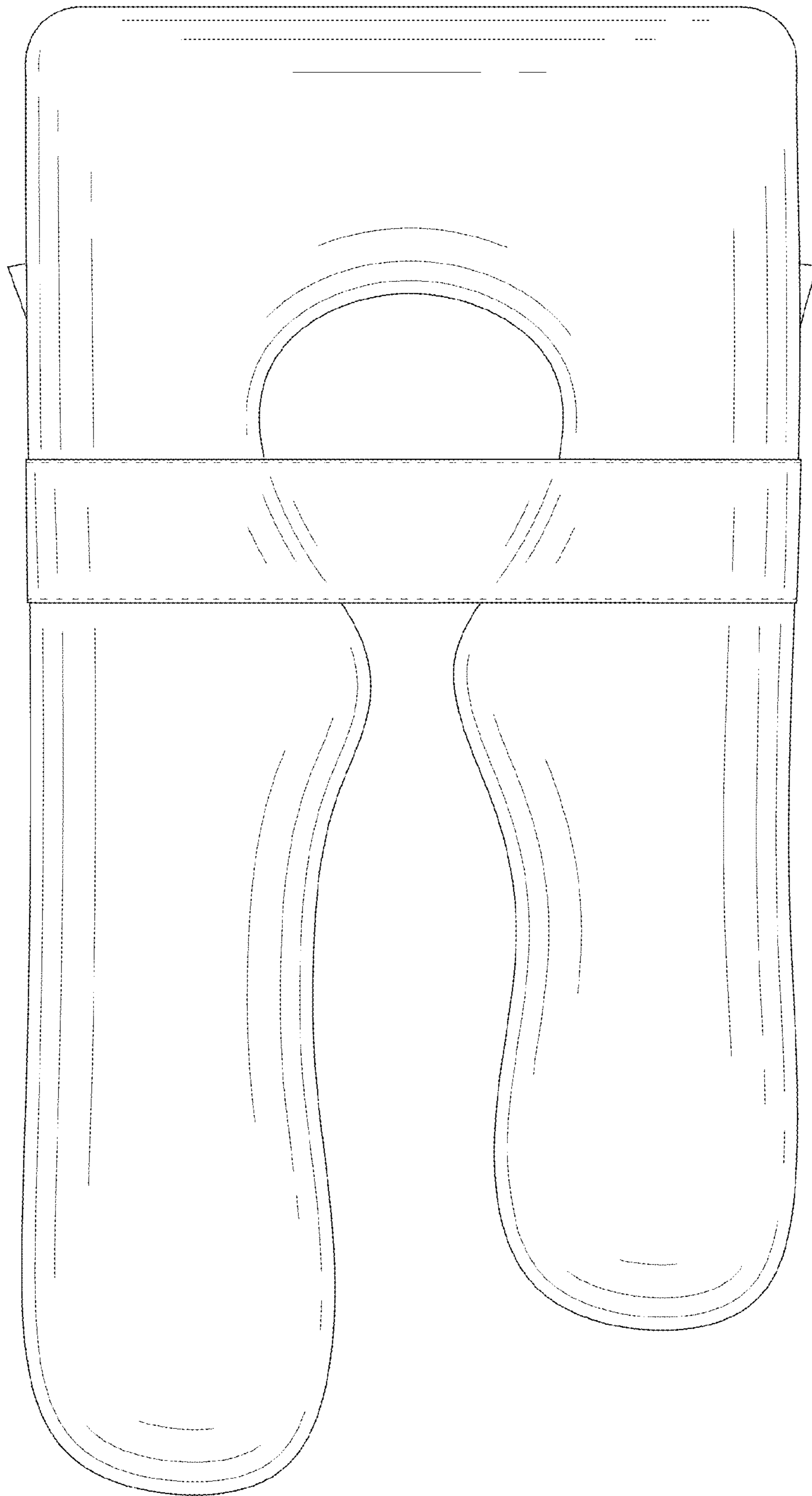

FIG. 3

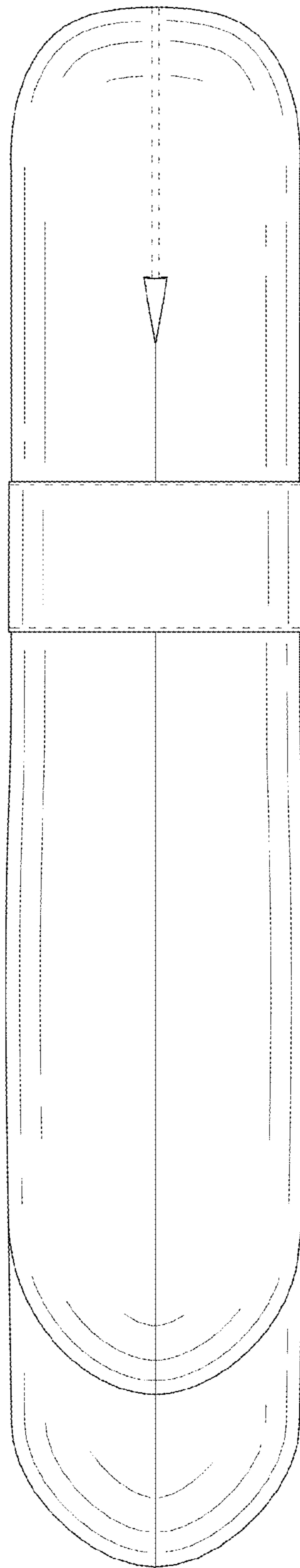

FIG. 4

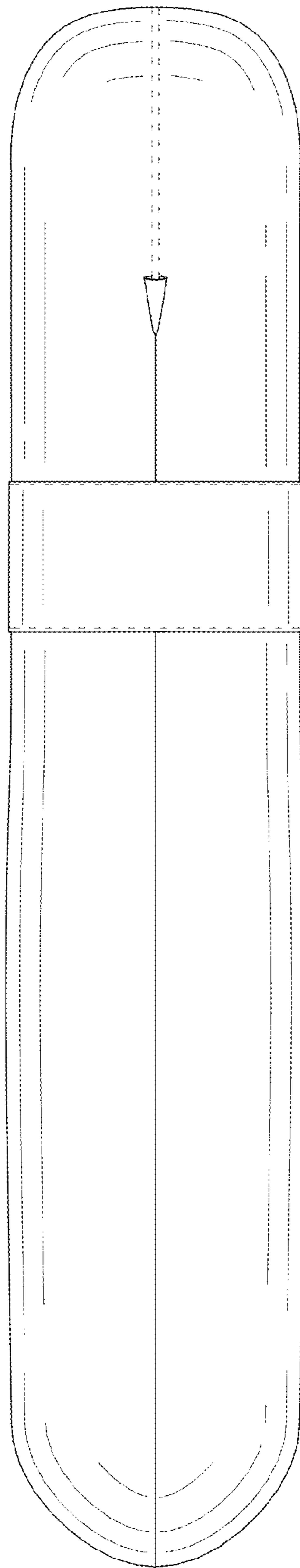

FIG. 5

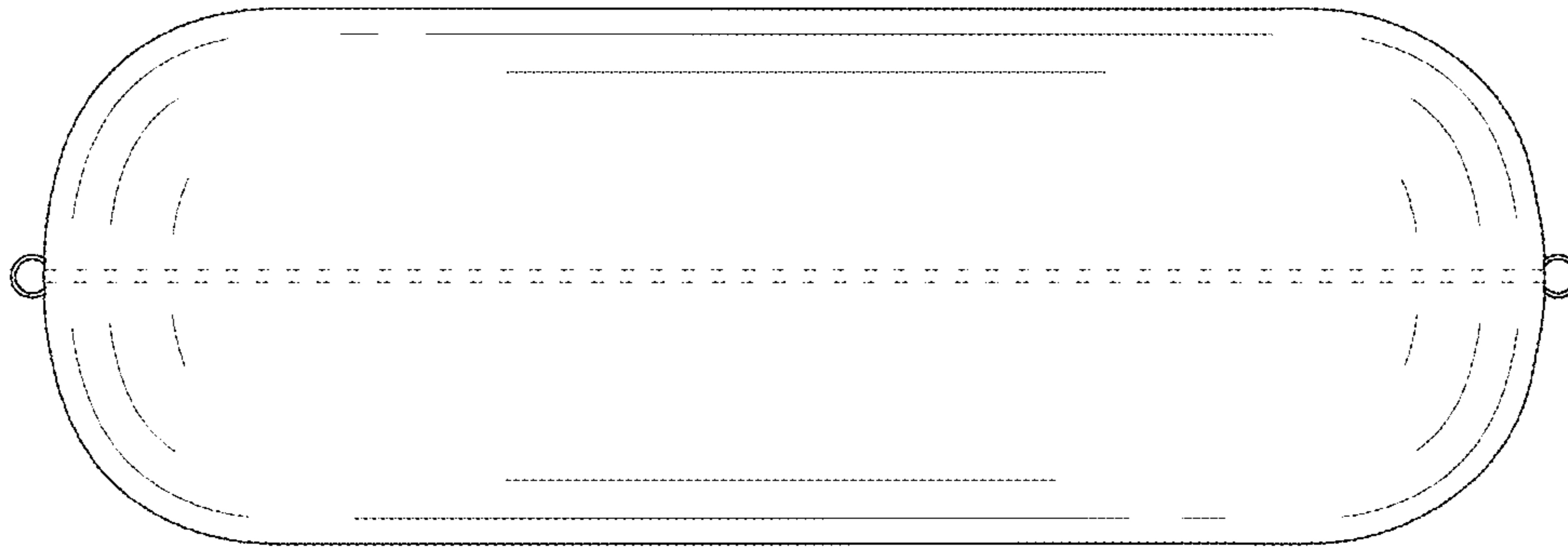

FIG.6

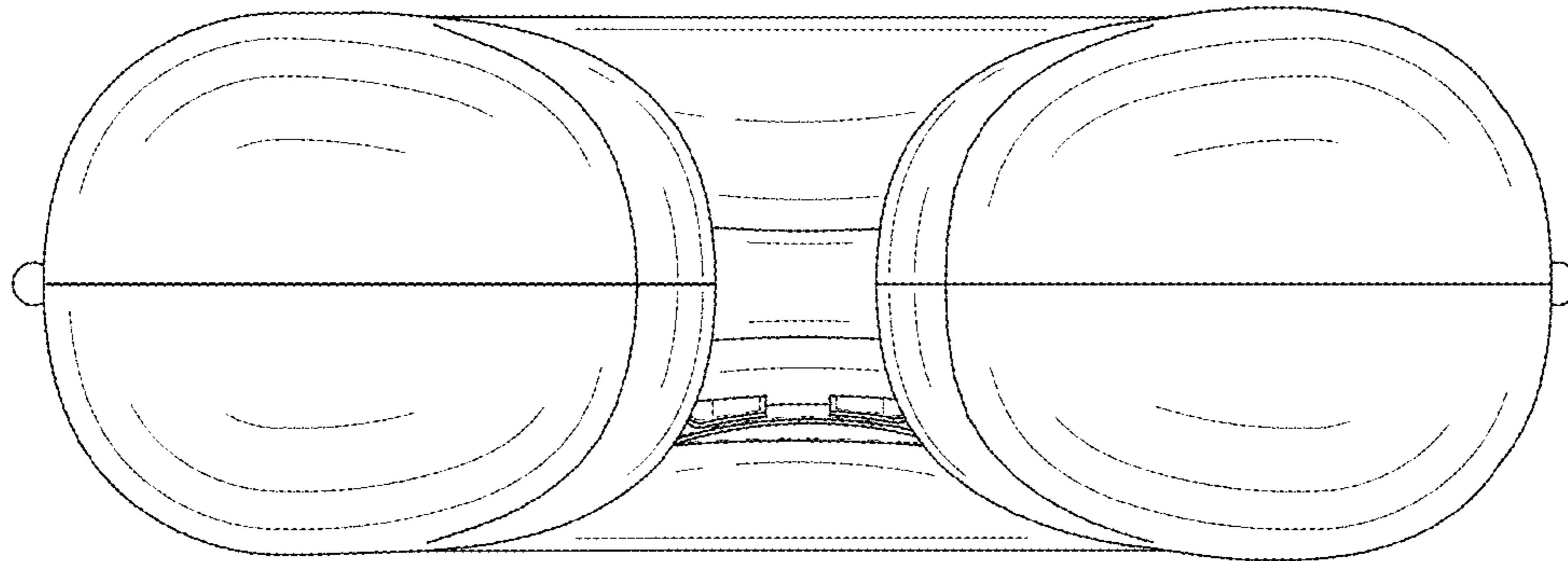

FIG. 7