



US00D970248S

(12) **United States Design Patent** (10) **Patent No.:** **US D970,248 S**  
**Chen** (45) **Date of Patent:** **\*\* Nov. 22, 2022**

(54) **BATHROOM TISSUE CABINET**  
(71) Applicant: **SHENZHENSHI GUANQI E-COMMERCE CO., LTD.**, Shenzhen (CN)  
(72) Inventor: **Haina Chen**, Shenzhen (CN)  
(73) Assignee: **SHENZHENSHI GUANQI E-COMMERCE CO., LTD.**, Shenzhen (CN)  
(\*\*) Term: **15 Years**  
(21) Appl. No.: **29/821,114**  
(22) Filed: **Dec. 28, 2021**  
(51) **LOC (13) Cl.** ..... **06-04**  
(52) **U.S. Cl.**  
USPC ..... **D6/519; D6/524**  
(58) **Field of Classification Search**  
USPC ..... D6/515-524, 657, 662, 663, 664, 671, D6/671.1, 671.2; D3/201; 211/16, 85.5, 211/59.2; 221/92, 97, 185, 282-284; 242/159, 160.2, 550, 560, 590, 595, 588, 242/598  
CPC .. G06Q 10/087; G07C 9/00912; A47B 81/00; A47B 81/067; G06K 7/10297; A47K 10/34; A47K 2010/3233; A47K 10/38; A47K 2010/328  
See application file for complete search history.

D547,983 S \* 8/2007 Jackson, III ..... D6/520  
D551,000 S 9/2007 Romano  
D553,403 S \* 10/2007 Williams ..... D6/520  
D660,626 S \* 5/2012 Garner ..... D6/520  
D660,627 S \* 5/2012 Garner ..... D6/520  
D871,100 S \* 12/2019 Trunsky ..... D6/518  
D935,800 S \* 11/2021 Chen ..... D6/523  
2008/0296331 A1 \* 12/2008 Kiosk ..... B60R 7/087 224/547

**OTHER PUBLICATIONS**

Amazon.com, WODETREE Upgrade Small Bathroom Storage Cabinet with 2 Doors and 2 Shelves, Aug. 20, 2021, <https://www.amazon.com/WODETREE-Upgrade-Bathroom-Storage-Organizer/dp/B09LVP7GFB/> (Year: 2021).\*

(Continued)

*Primary Examiner* — Nathan M Johnston

(57) **CLAIM**

The ornamental design for a bathroom tissue cabinet, as shown and described.

**DESCRIPTION**

FIG. 1 is a perspective view of a bathroom tissue cabinet showing my new design;  
FIG. 2 is another perspective view thereof;  
FIG. 3 is a front elevational view thereof;  
FIG. 4 is a rear elevational view thereof;  
FIG. 5 is a left side elevational view thereof;  
FIG. 6 is a right side elevational view thereof;  
FIG. 7 is a top plan view thereof;  
FIG. 8 is a bottom plan view thereof; and,  
FIG. 9 is an exploded perspective view of the bathroom tissue cabinet.

The broken lines in the drawings depict portions of the bathroom tissue cabinet that form no part of the claimed design.

**1 Claim, 9 Drawing Sheets**

(56) **References Cited**  
U.S. PATENT DOCUMENTS  
D77,044 S \* 11/1928 Steiner ..... D6/522  
D87,356 S \* 7/1932 Post ..... D6/522  
6,302,350 B1 \* 10/2001 Burrell ..... A47K 10/38 242/560  
D482,914 S \* 12/2003 Prasad ..... D6/520  
D502,348 S \* 3/2005 Mendini ..... D6/553  
D508,354 S \* 8/2005 D'Agostino ..... D6/520

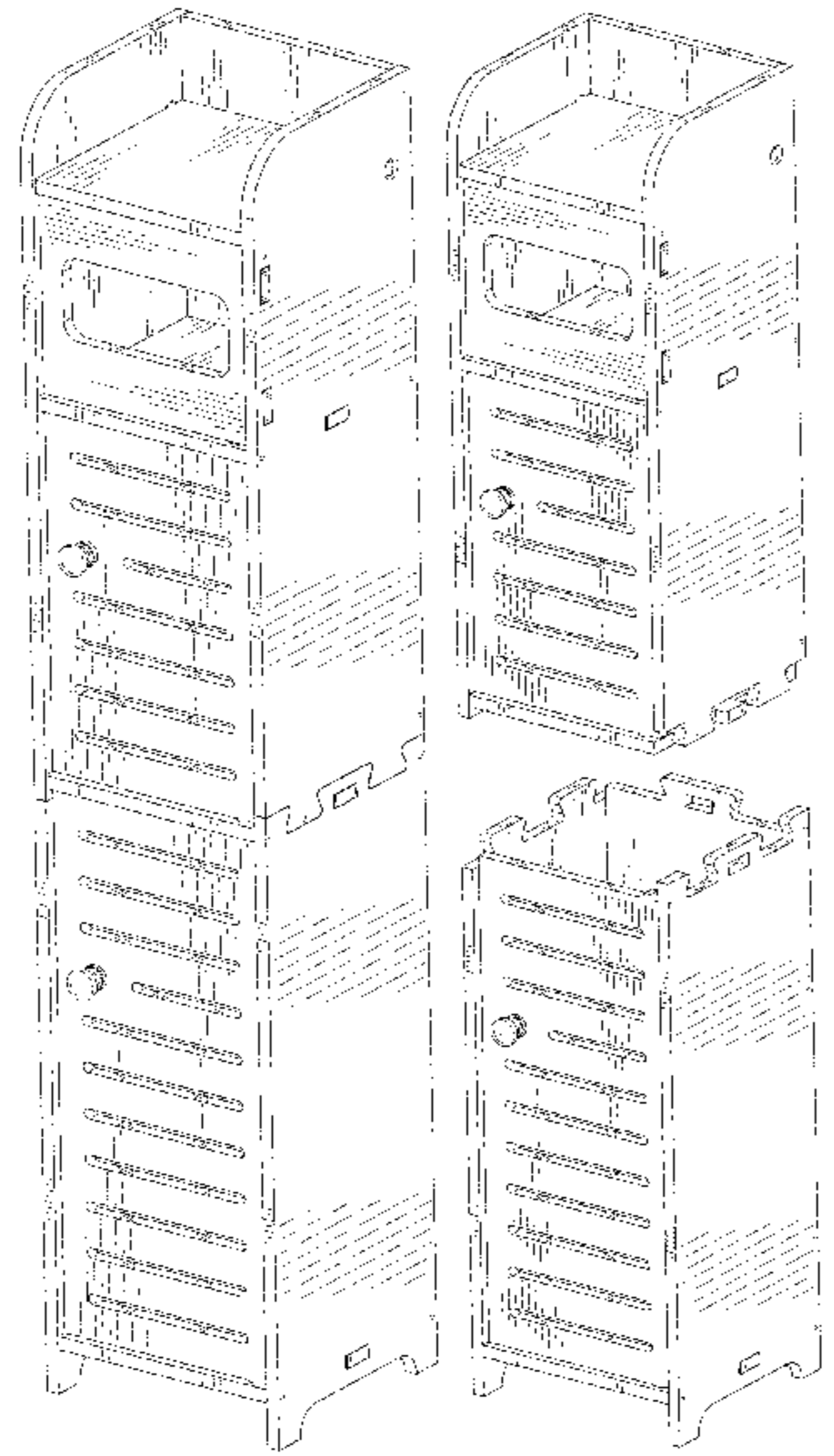

(56)

**References Cited**

OTHER PUBLICATIONS

Amazon.com, AIRE Small Bathroom Storage Cabinet with 2 Doors and 2 Shelves, Aug. 23, 2021, <https://www.amazon.com/AIRE-Bathroom-Storage-Cabinet-Organizer/dp/B096FGRRMT?th=1> (Year: 2021).\*

Youtube.com, Review of AIRE Small Bathroom Storage Cabinet with 2 Doors and 2 Shelves, Aug. 18, 2021, <https://www.youtube.com/watch?v=HzQvYpvJc2w> (Year: 2021).\*

\* cited by examiner

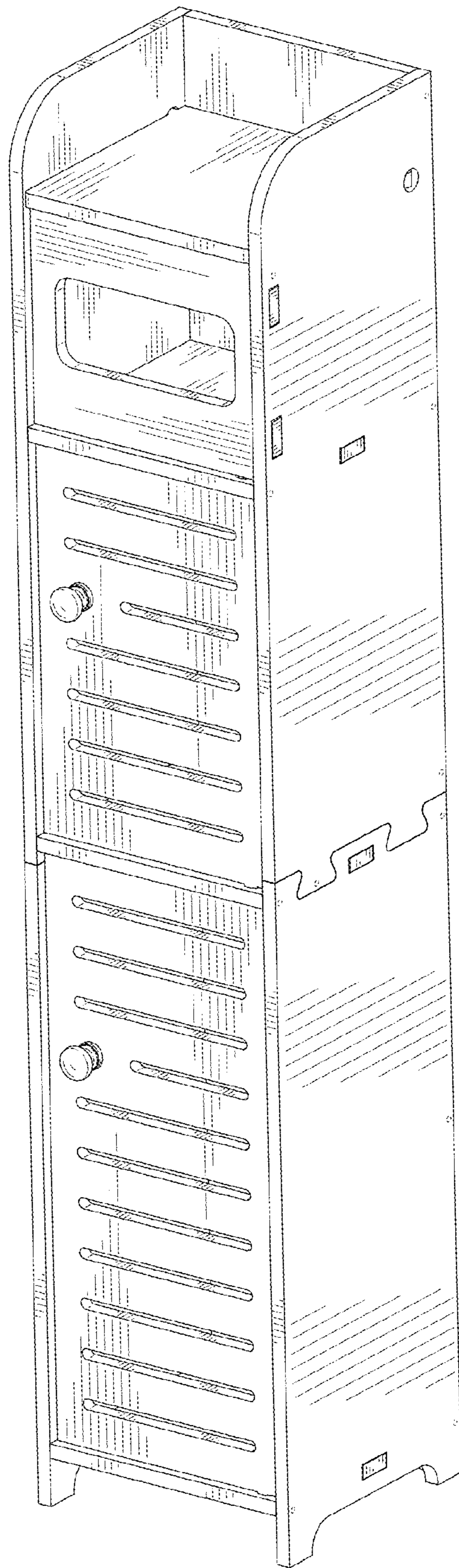

FIG. 1

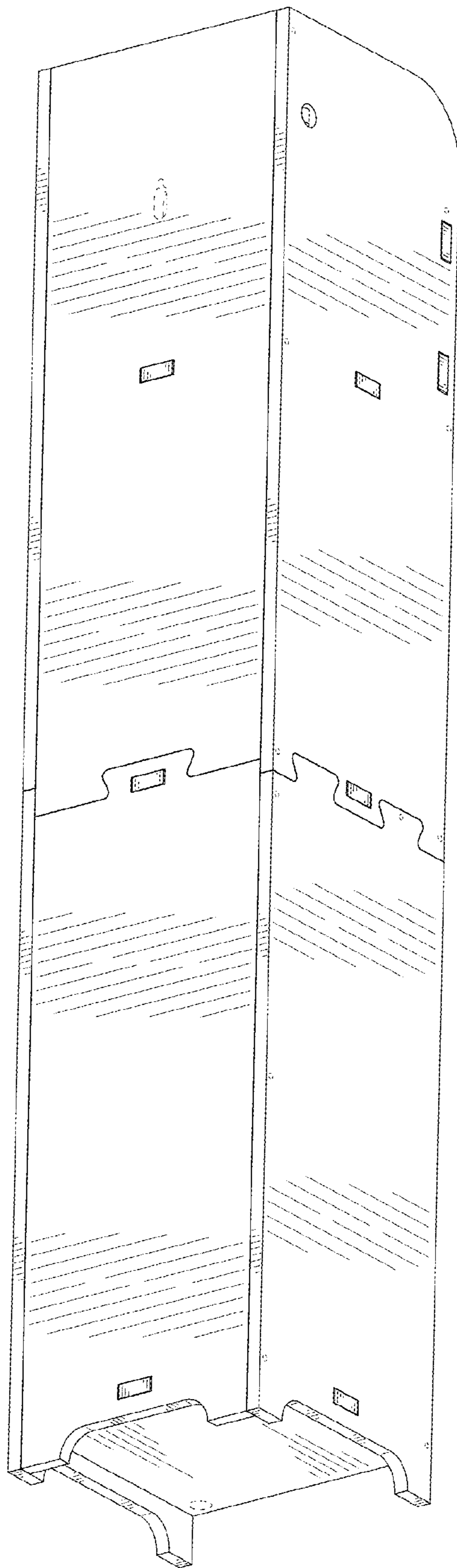

FIG. 2

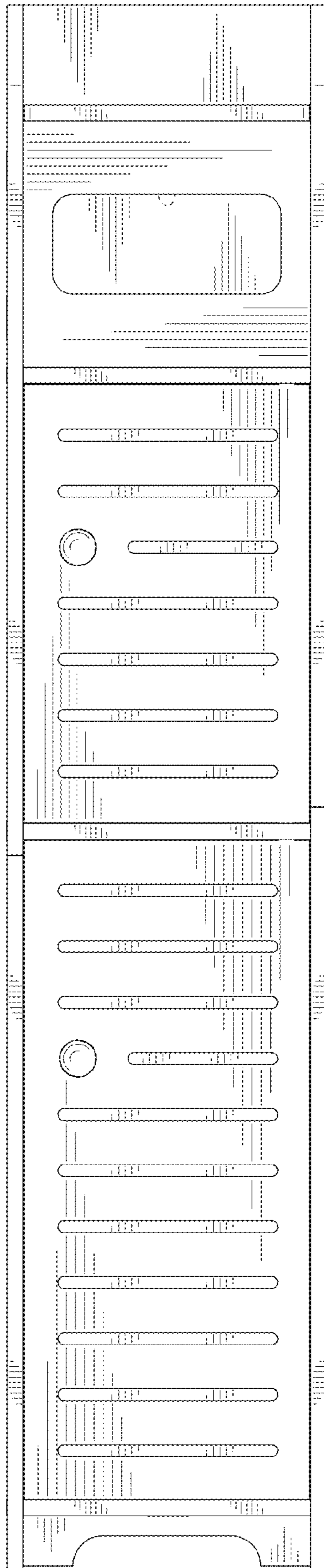

FIG. 3

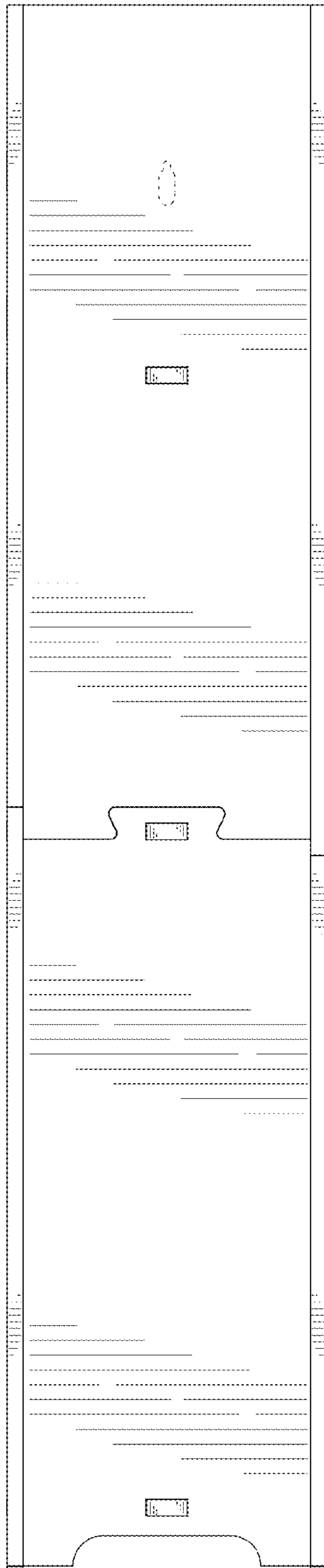

FIG. 4

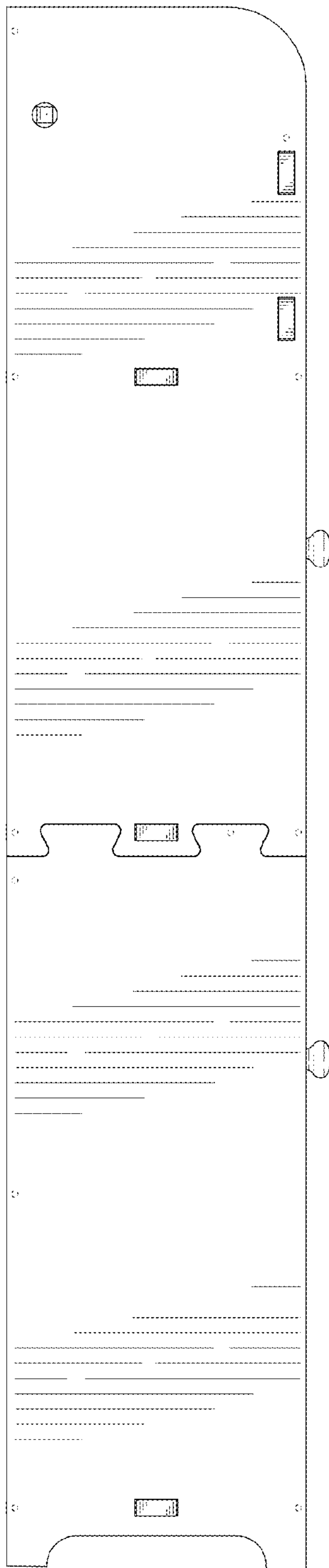

FIG. 5

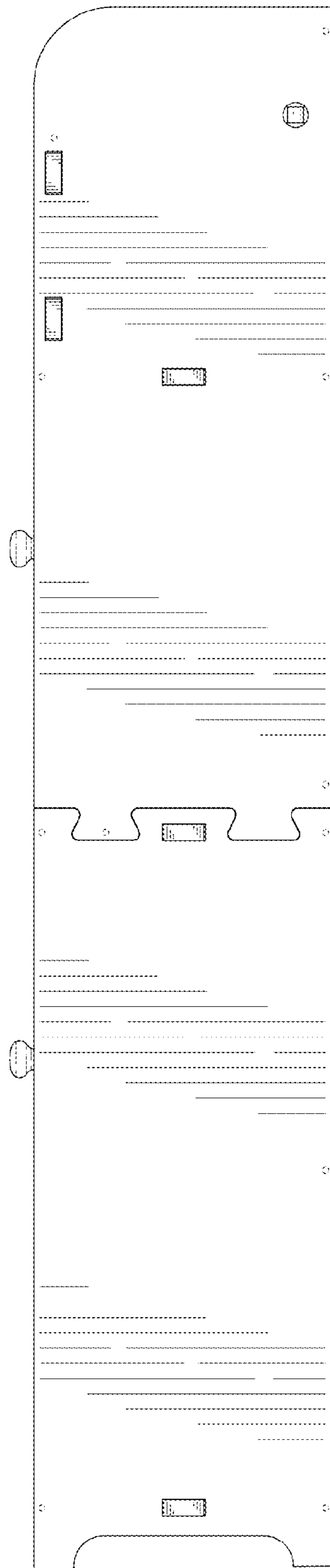

FIG. 6



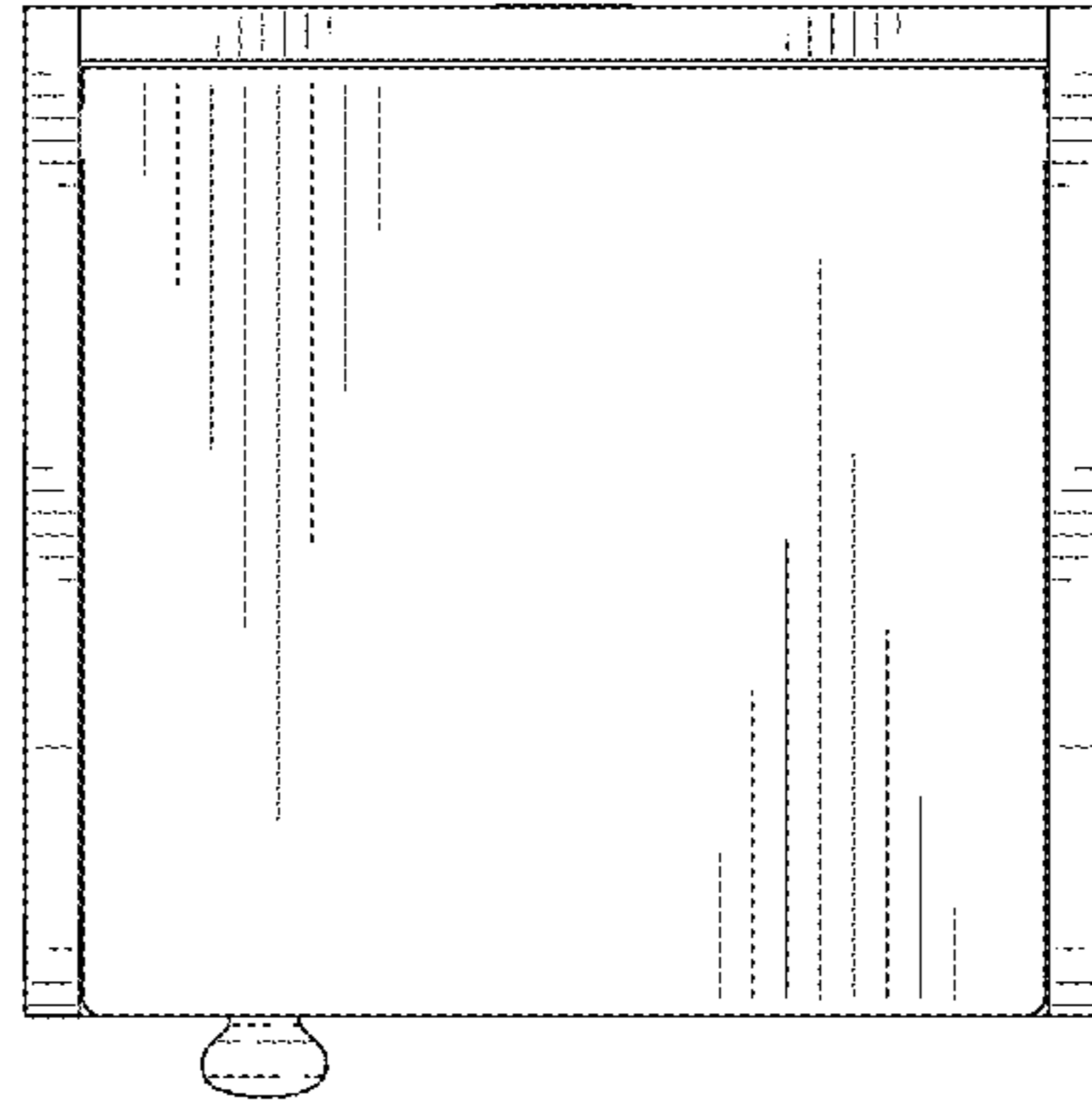

FIG. 7

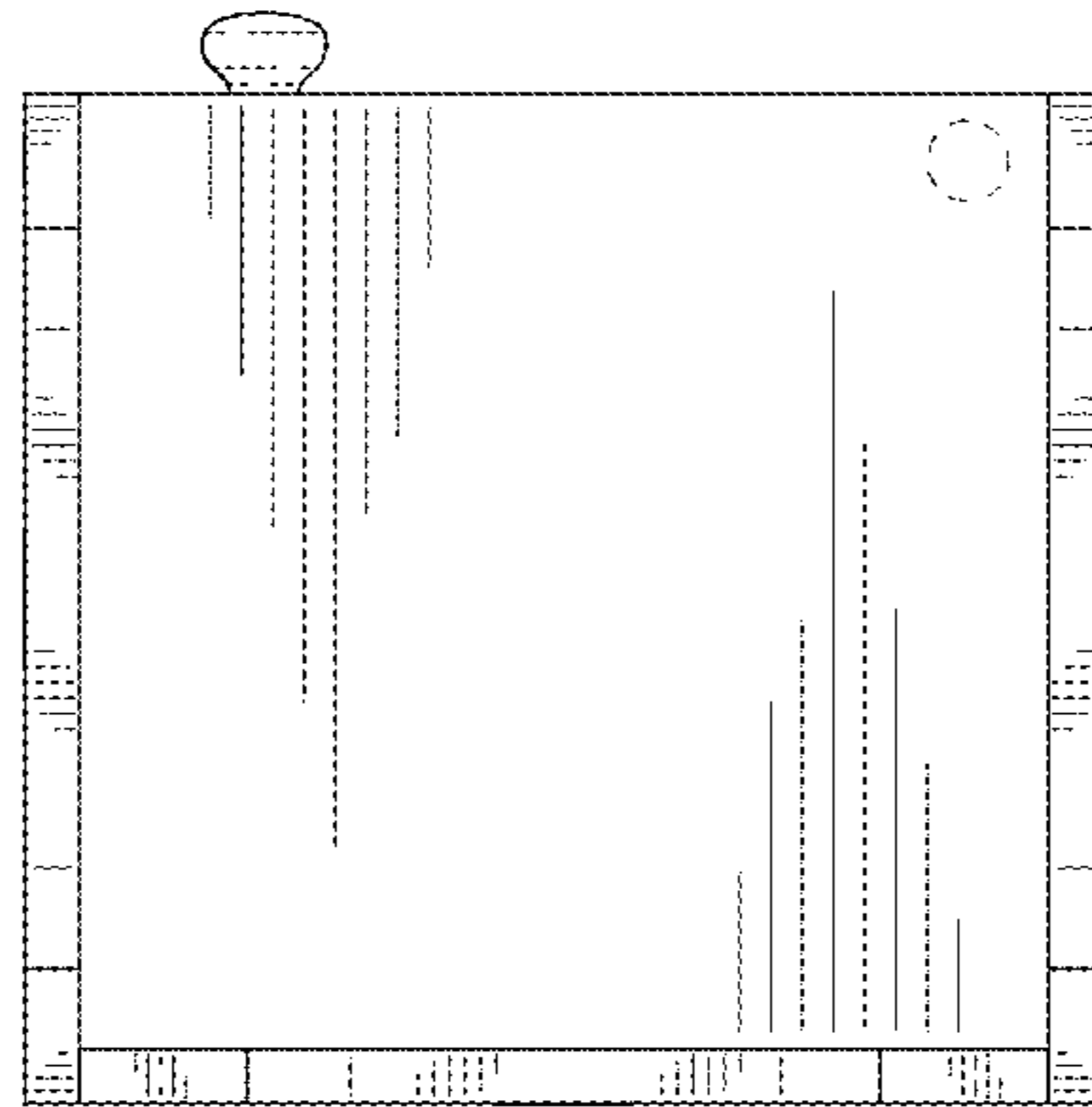

FIG. 8

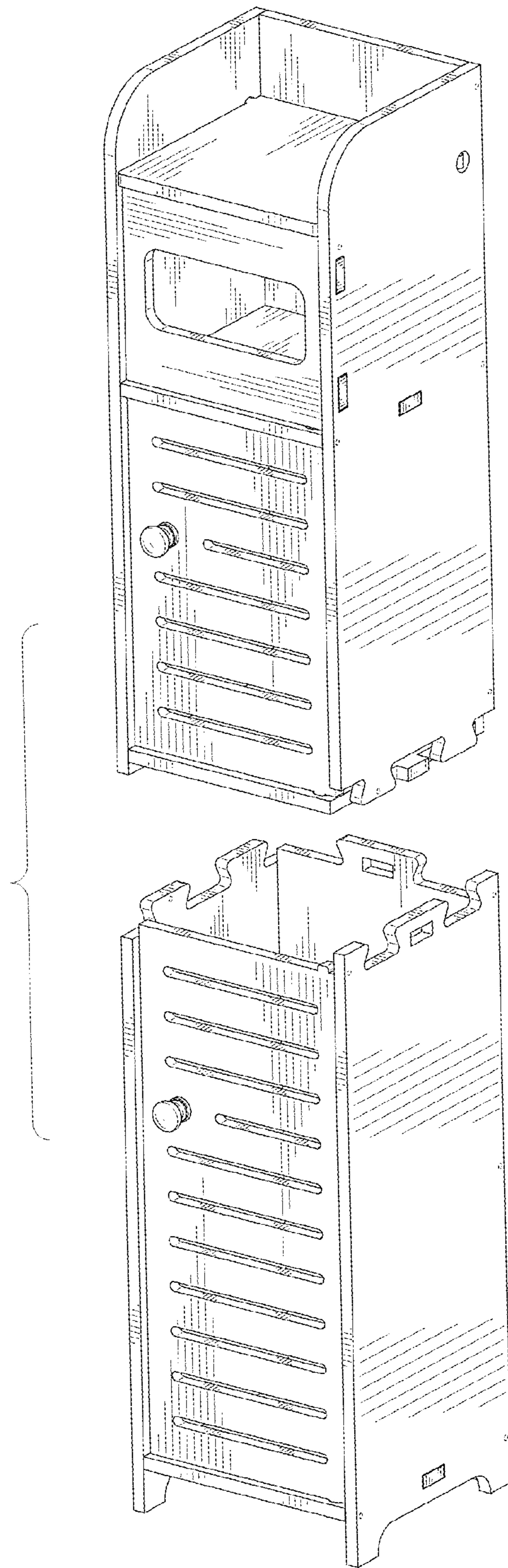

FIG. 9



US00D970248C1

(12) **EX PARTE REEXAMINATION CERTIFICATE** (12779th)  
**United States Patent**  
**Chen**

(10) **Number:** **US D970,248 C1**  
(45) **Certificate Issued:** **Nov. 27, 2024**

- (54) **BATHROOM TISSUE CABINET**
- (71) Applicant: **SHENZHENSHI GUANQI E-COMMERCE CO., LTD.**, Shenzhen (CN)
- (72) Inventor: **Haina Chen**, Shenzhen (CN)
- (73) Assignee: **SHENZHENSHI GUANQI E-COMMERCE CO., LTD.**, Shenzhen (CN)

- Appl. No.: **29/821,114**
- Filed: **Dec. 28, 2021**
- (51) **LOC (14) CI.** ..... **06-04**
- (52) **U.S. CI.**  
USPC ..... **D6/519; D6/524**
- (58) **Field of Classification Search**  
USPC ..... **D6/520**  
See application file for complete search history.

**Reexamination Request:**  
No. 90/015,306, Oct. 2, 2023

**Reexamination Certificate for:**  
Patent No.: **Des. 970,248**  
Issued: **Nov. 22, 2022**

- (56) **References Cited**  
To view the complete listing of prior art documents cited during the proceeding for Reexamination Control Number 90/015,306, please refer to the USPTO's Patent Electronic System.

*Primary Examiner* — Brett Miller

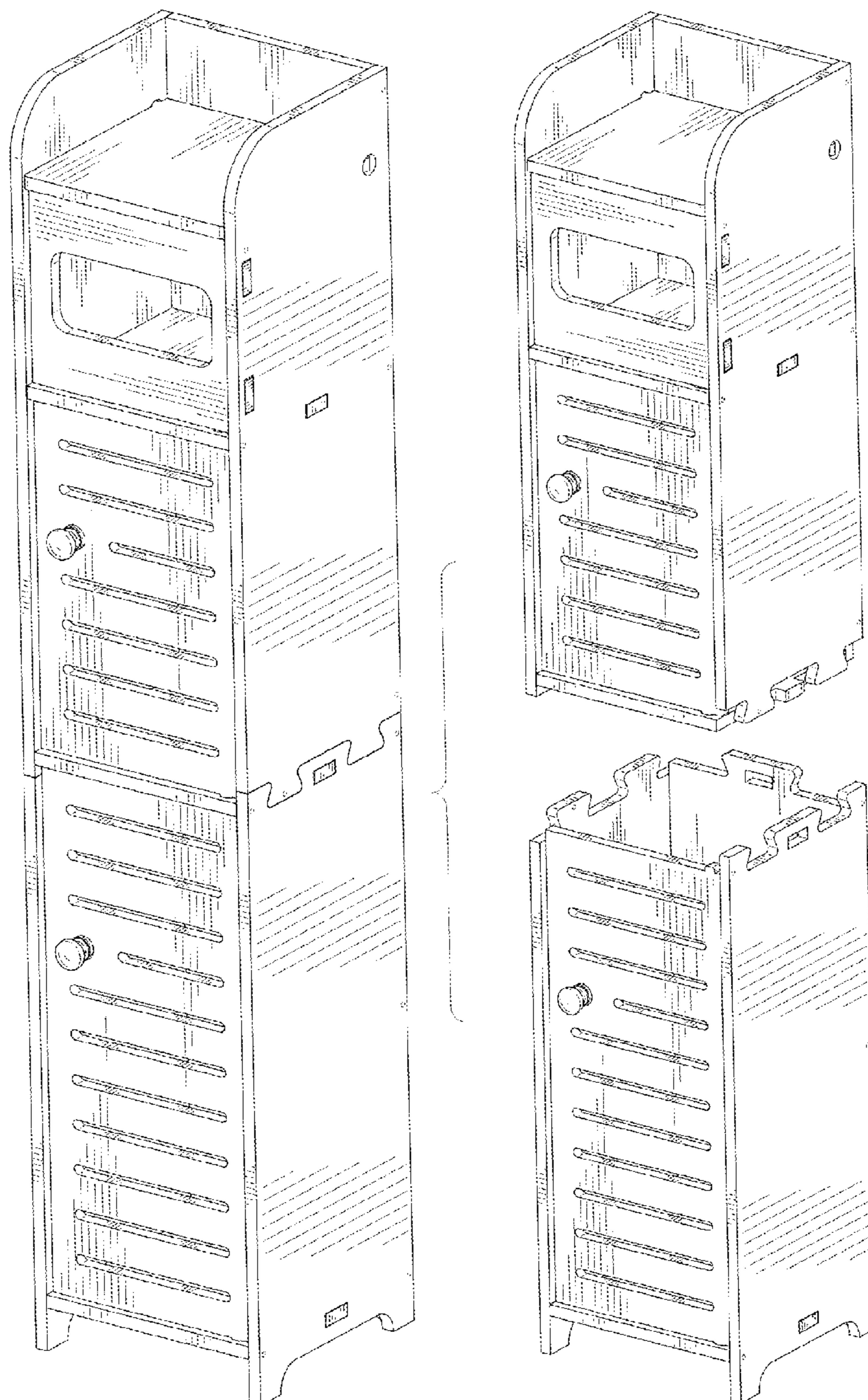

**1**  
**EX PARTE**  
**REEXAMINATION CERTIFICATE**

NO AMENDMENTS HAVE BEEN MADE TO 5  
THE PATENT

AS A RESULT OF REEXAMINATION, IT HAS BEEN  
DETERMINED THAT:

The patentability of claim 1 is confirmed. 10

\* \* \* \* \*