



US00D970215S

(12) **United States Design Patent**
Gao

(10) **Patent No.:** **US D970,215 S**

(45) **Date of Patent:** **** Nov. 22, 2022**

(54) **GUN CLEANING KIT CASE**

OTHER PUBLICATIONS

(71) Applicant: **Jingbo Gao**, Ningbo (CN)

(72) Inventor: **Jingbo Gao**, Ningbo (CN)

(**) Term: **15 Years**

(21) Appl. No.: **29/795,184**

(22) Filed: **Jun. 17, 2021**

(51) **LOC (13) Cl.** **03-01**

(52) **U.S. Cl.**
USPC **D3/262; D3/282; D3/284; D3/904;**
D3/905

(58) **Field of Classification Search**
USPC **D3/262, 273, 276, 282, 284, 294, 298,**
D3/905

CPC **A45C 11/00**
See application file for complete search history.

(56) **References Cited**

U.S. PATENT DOCUMENTS

D358,257 S *	5/1995	Sidabras	D3/282
D391,760 S *	3/1998	Zeller	D3/276
D392,463 S *	3/1998	Grey	D3/319
D413,440 S *	9/1999	Schurman	D3/276
D516,311 S *	3/2006	Lai	D3/282
D668,455 S *	10/2012	Chang	D3/905
D754,436 S	4/2016	Ou		
D785,938 S	5/2017	Ou		
D841,981 S	3/2019	Kögel		
D852,506 S *	7/2019	Clayton	D3/294
D873,011 S	1/2020	Kao		
D891,769 S *	8/2020	Chen	D3/262
D897,675 S *	10/2020	Chen	D3/262
D932,187 S *	10/2021	Ye	D3/294

Amazon, "GLORYFIRE Gun Cleaning Kit . . .", First on sale Jan. 20, 2021. (<https://www.amazon.com/dp/B08TH8DPQS/>) (Year: 2021).*
GLORYFIRE Elite Gun Cleaning Kit for Handgun Shotgun Rifle Cleaning Kit for All Guns with Reinforced and Lengthened Rods, Cotton Mop, High-end Double Head Brushes, Bronze Brushes with Steel Wire, Amazon.com, Jan. 20, 2021, GLORYFIRE, <https://www.amazon.com/dp/B08TH8DPQS/?th=1> (Last accessed: Aug. 16, 2022).

* cited by examiner

Primary Examiner — April Rivas

(74) Attorney, Agent, or Firm — Runit Ranjit Kanakia

(57) **CLAIM**

I claim the ornamental design for a gun cleaning kit case, as shown and described.

DESCRIPTION

FIG. 1 is a perspective view of a gun cleaning kit case showing my new design;
FIG. 2 is a hack perspective view thereof;
FIG. 3 is a front view thereof;
FIG. 4 is a back view thereof;
FIG. 5 is a bottom view thereof;
FIG. 6 is a top view thereof;
FIG. 7 is a left-side view thereof;
FIG. 8 is a right-side view thereof;
FIG. 9 is a perspective view of a gun cleaning kit case shown in a closed position; and,
FIG. 10 is an enlarged back perspective view of the area shown within the broken line circle in FIG. 2.
The broken lines in the drawings depict boundaries that form no part of the claimed design.

1 Claim, 10 Drawing Sheets

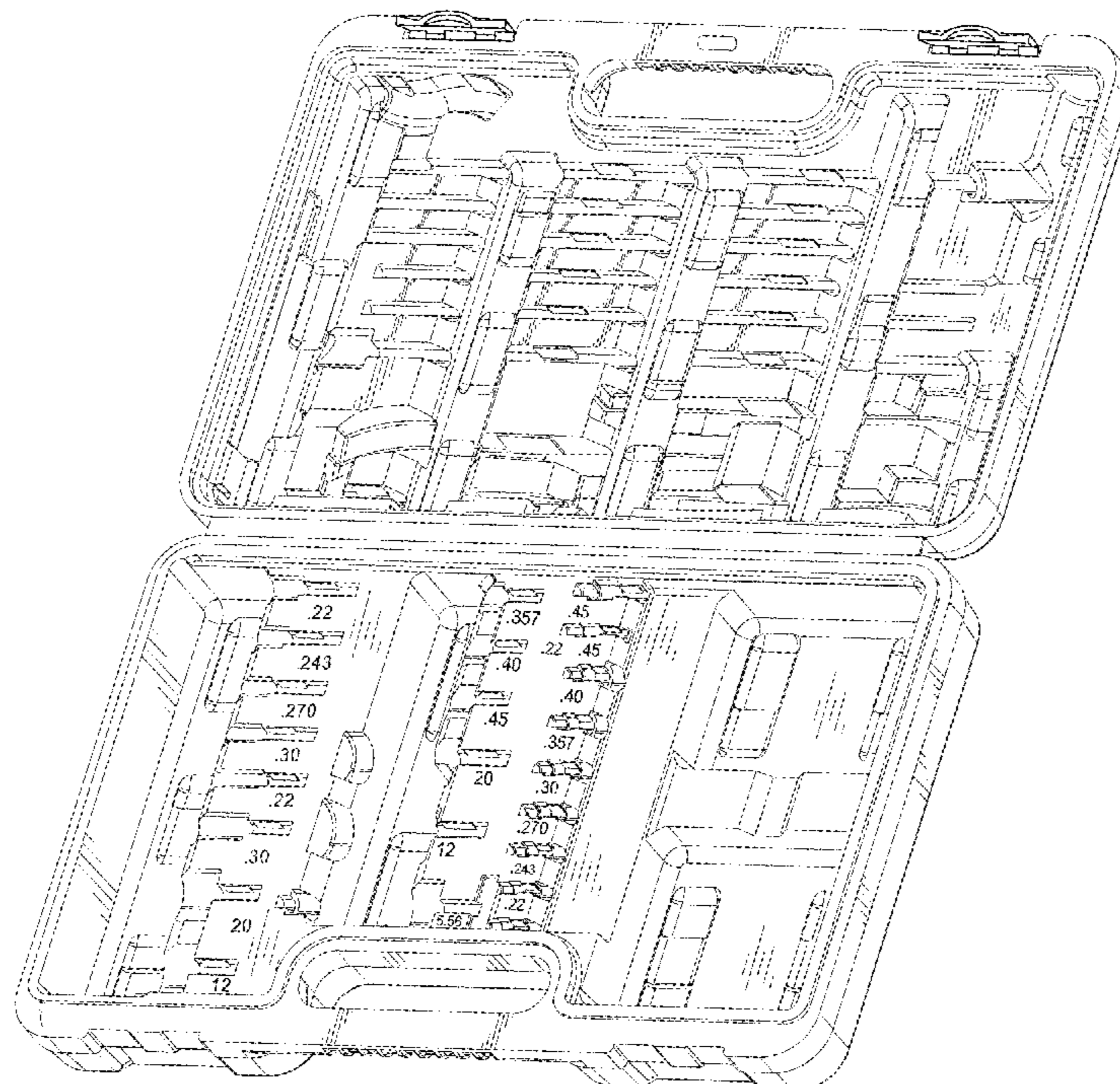

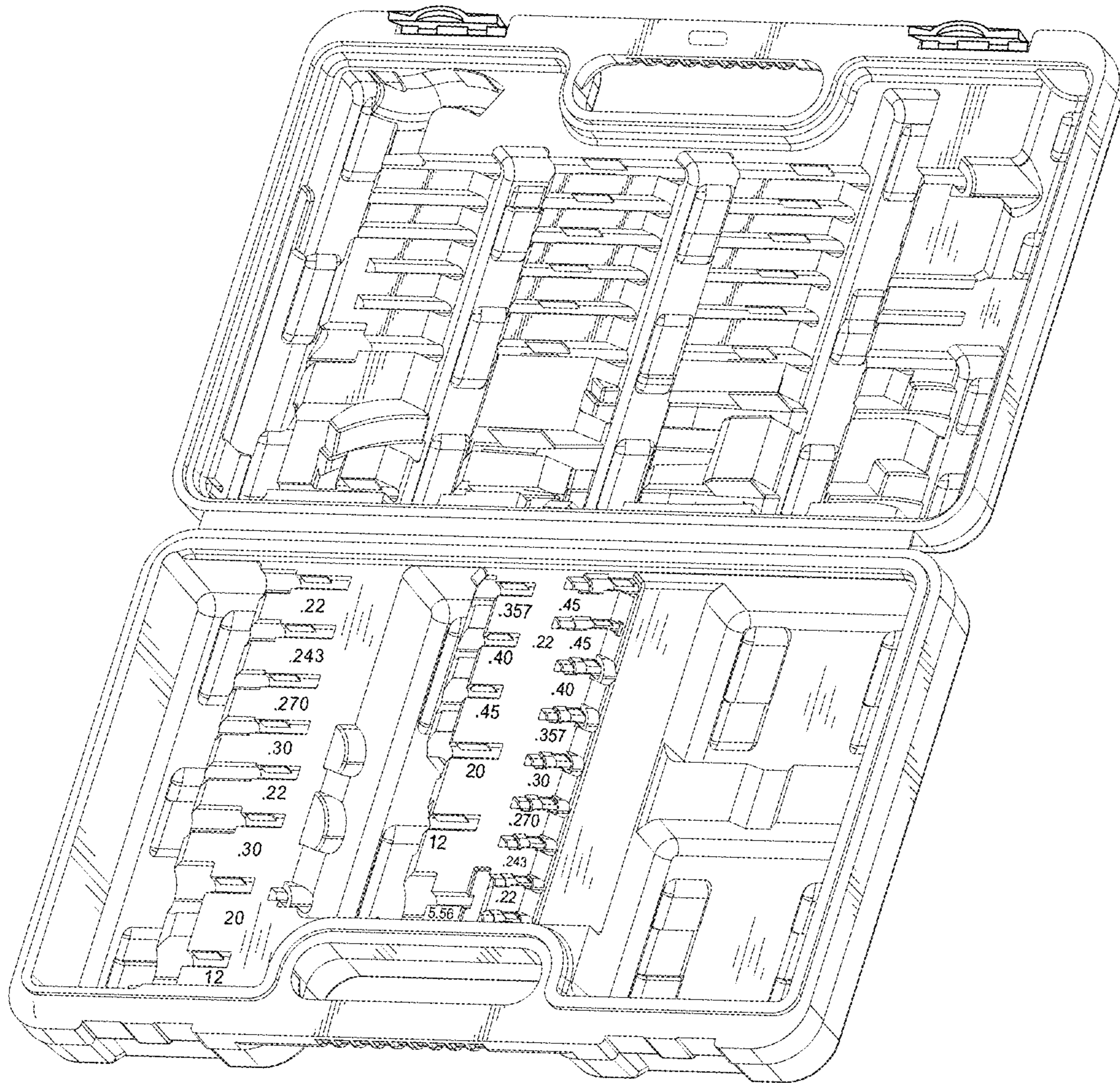

FIG. 1

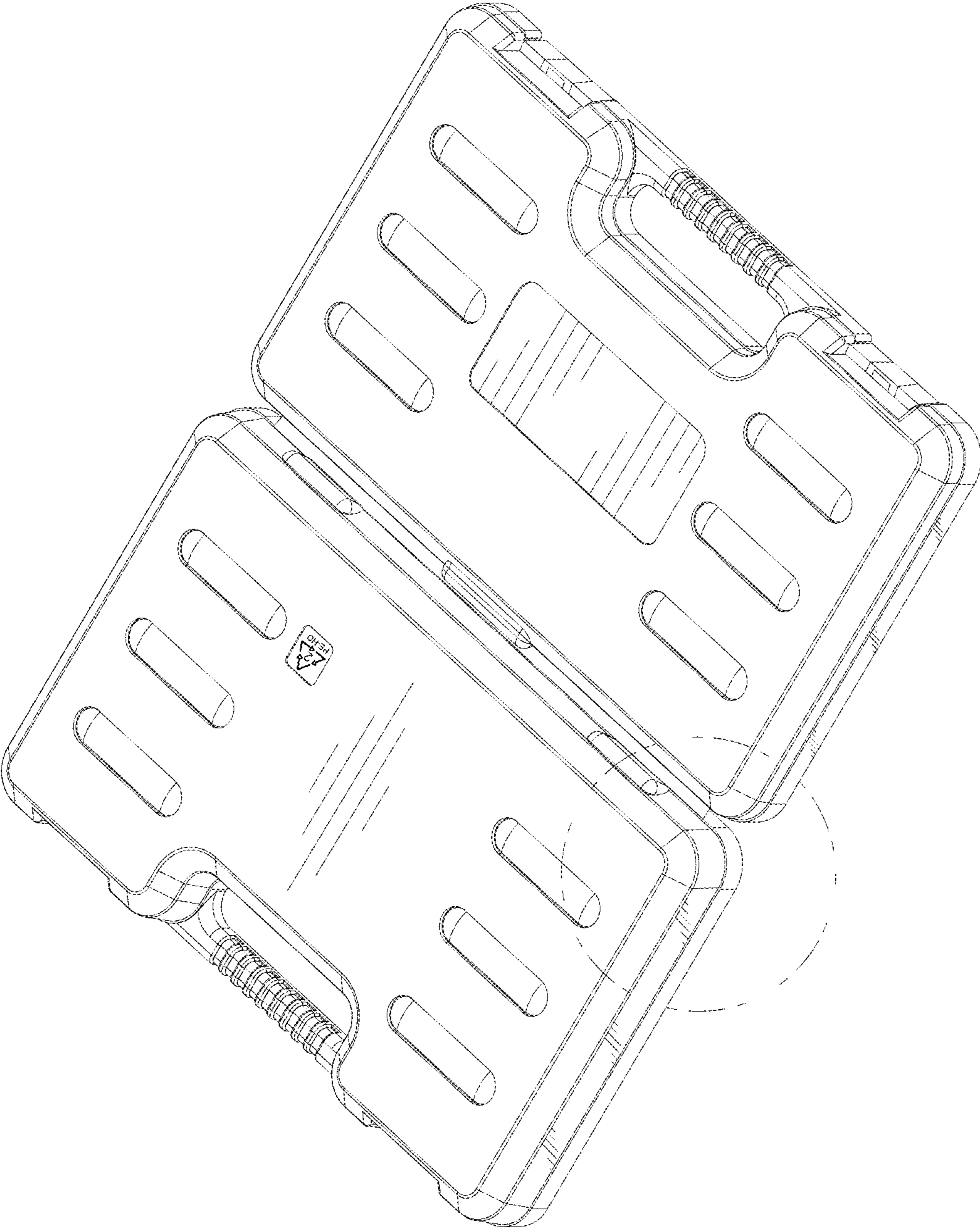

FIG. 2

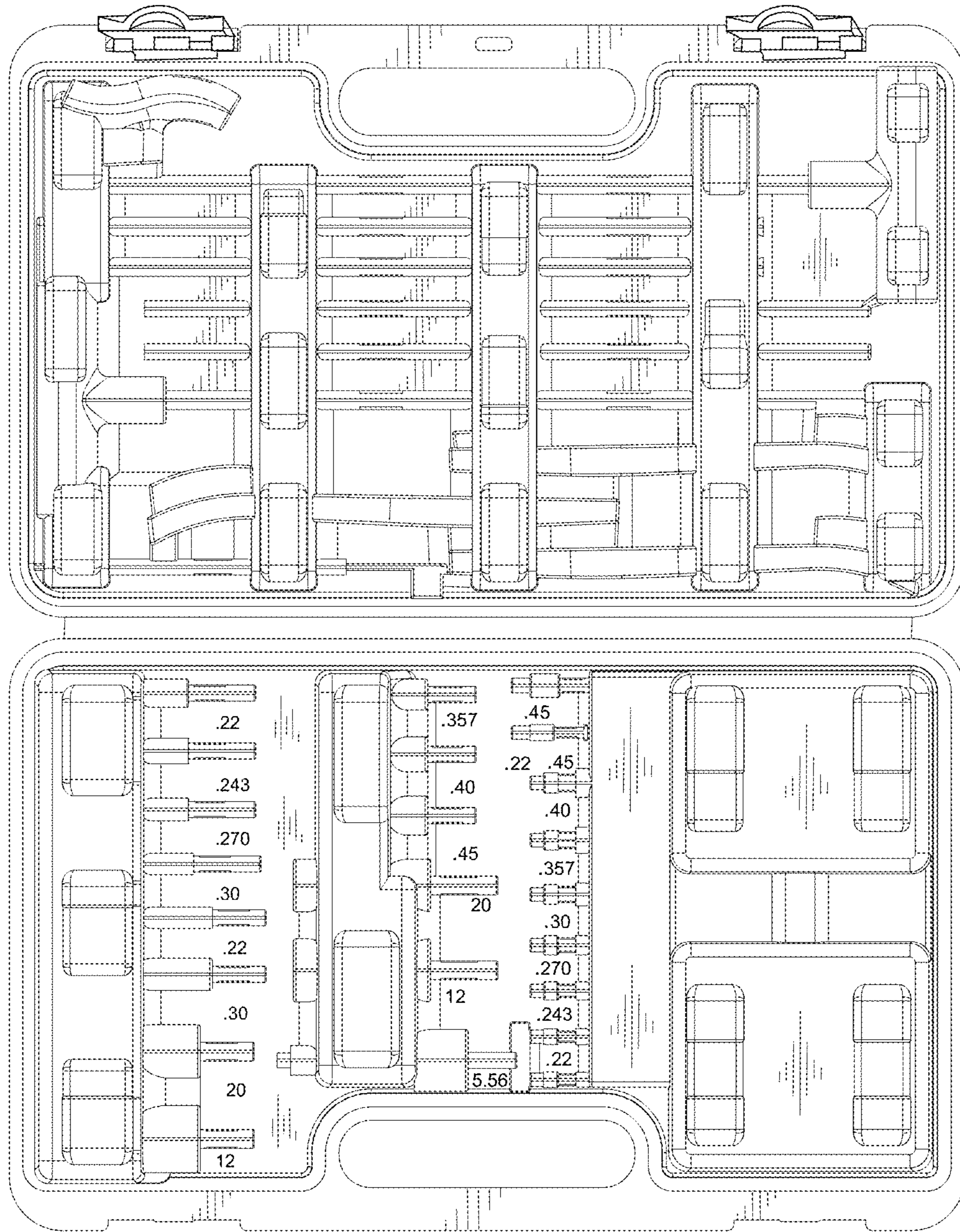

FIG. 3

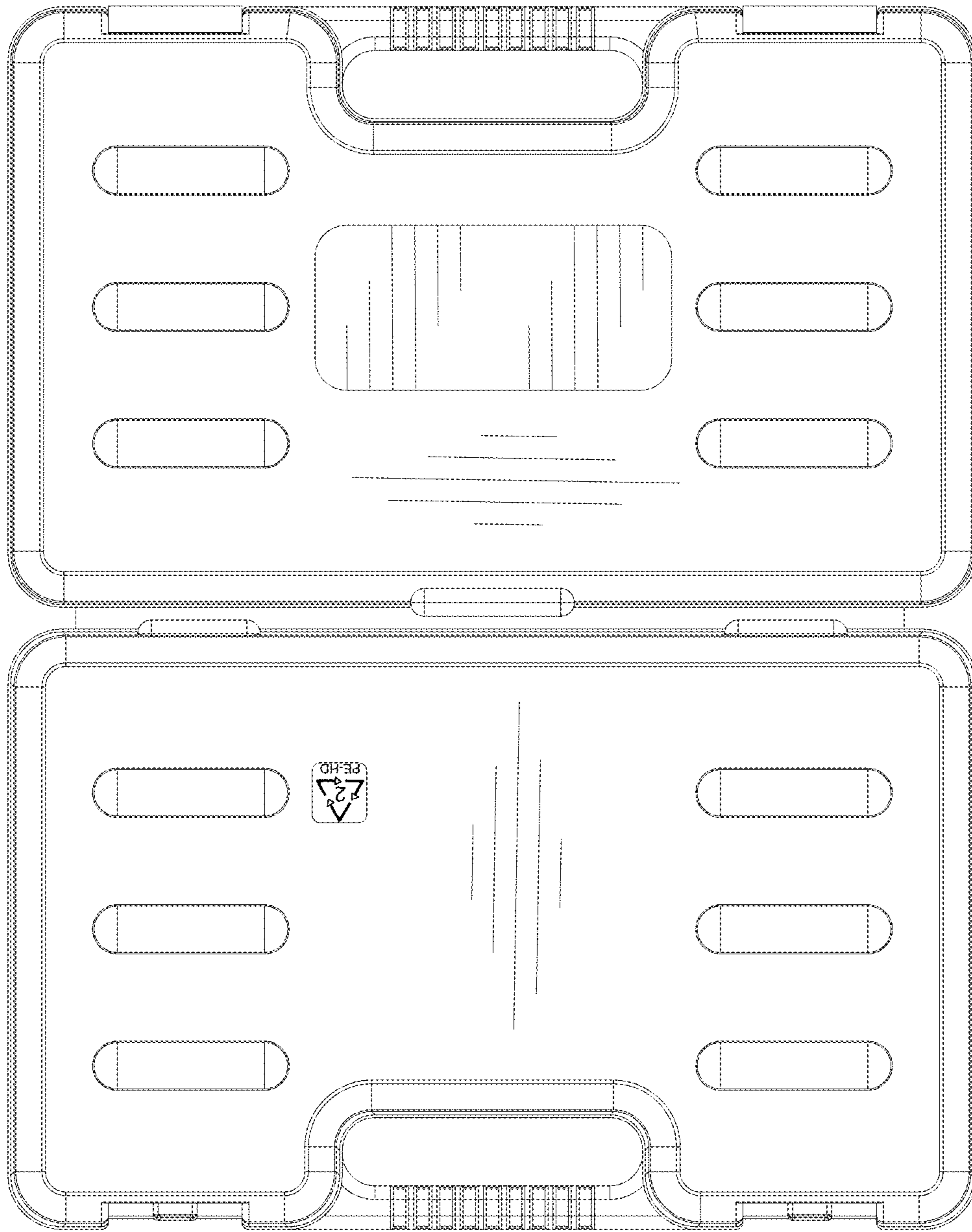

FIG. 4

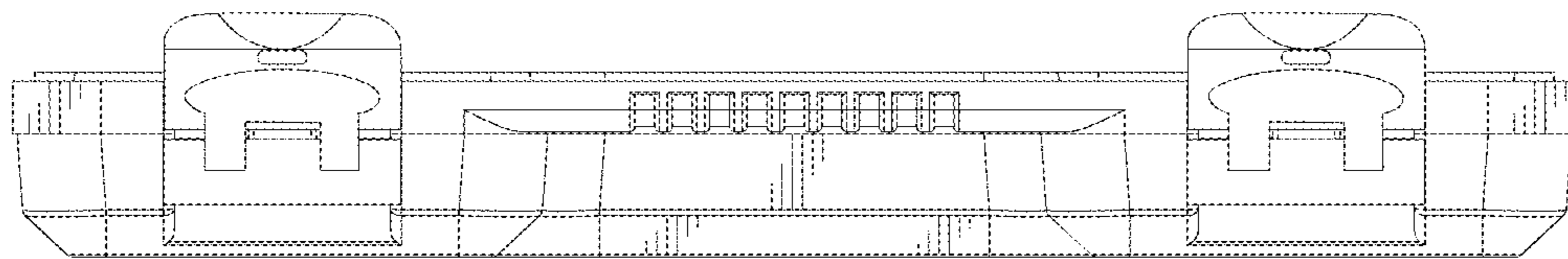

FIG. 5

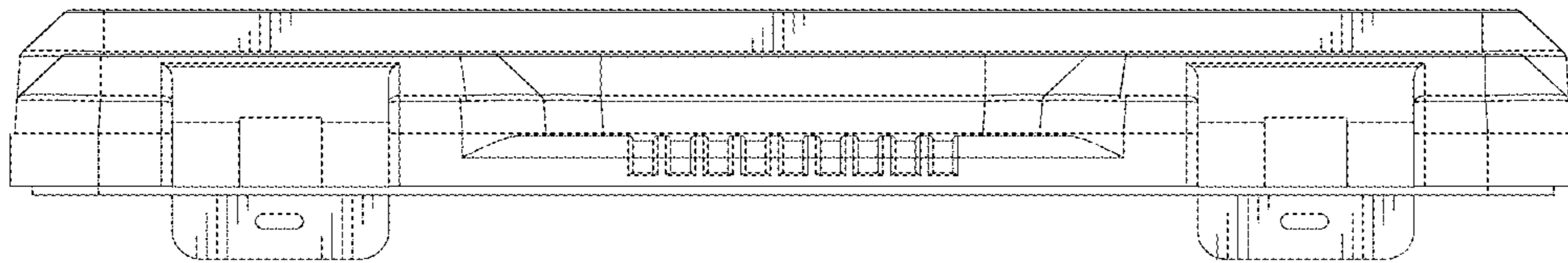

FIG. 6

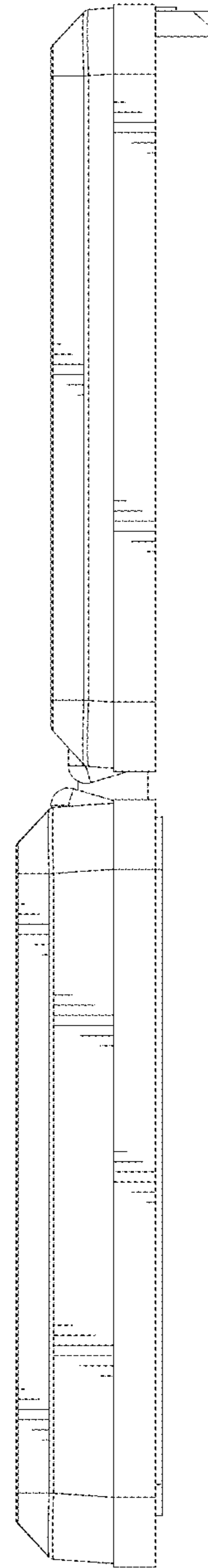

FIG. 7

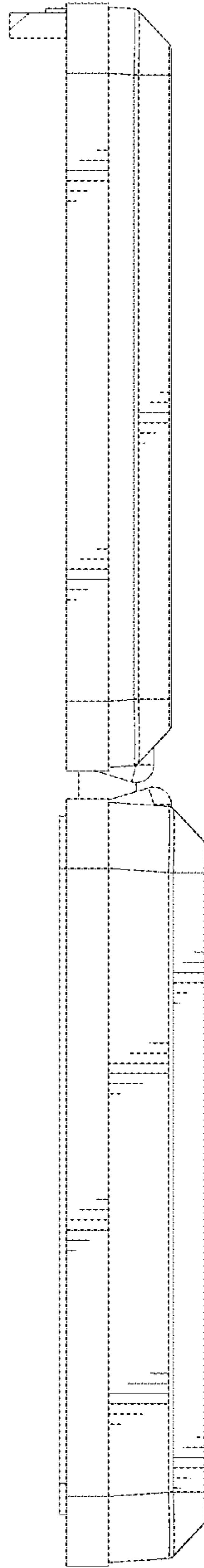

FIG. 8

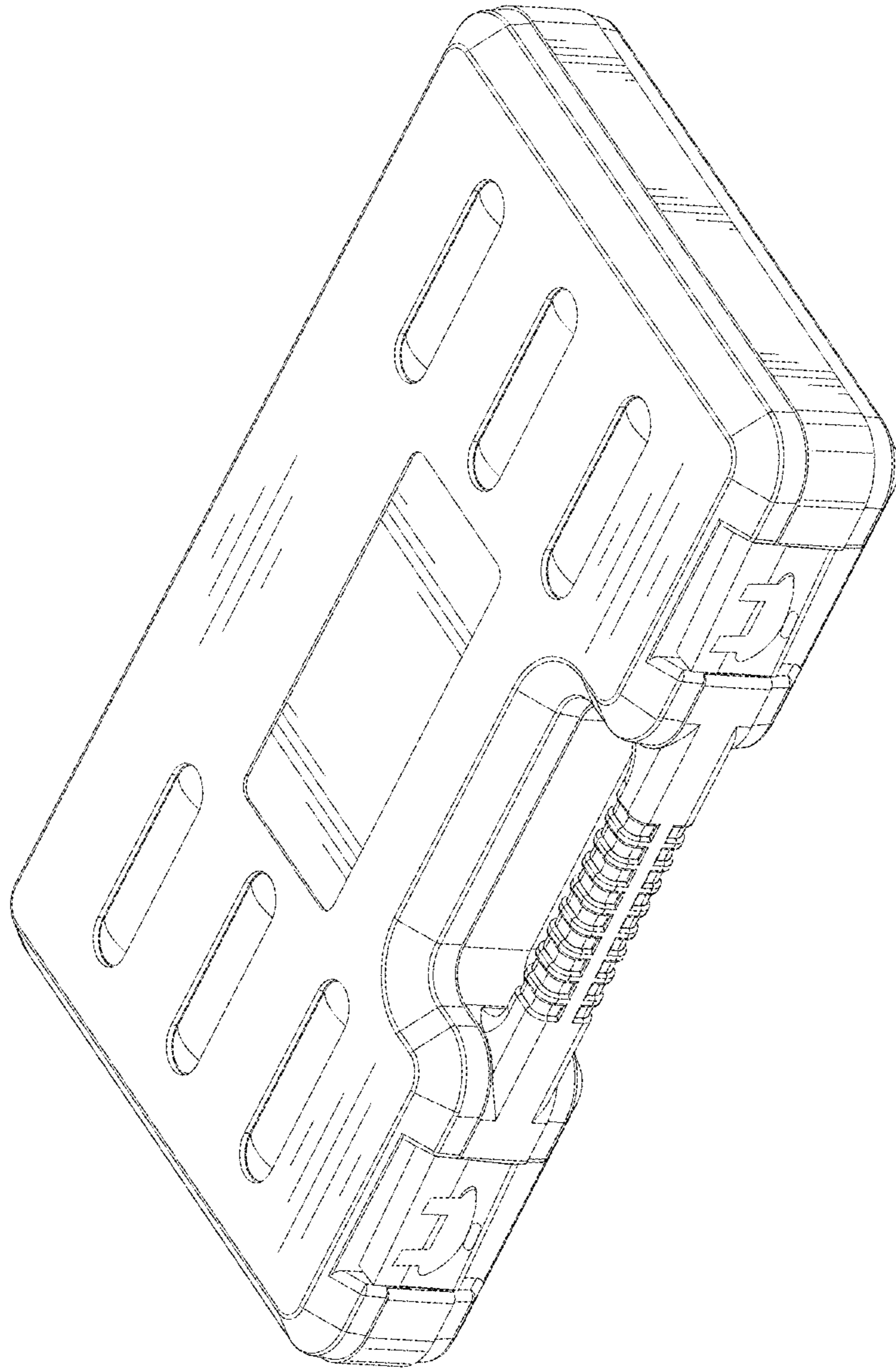

FIG. 9

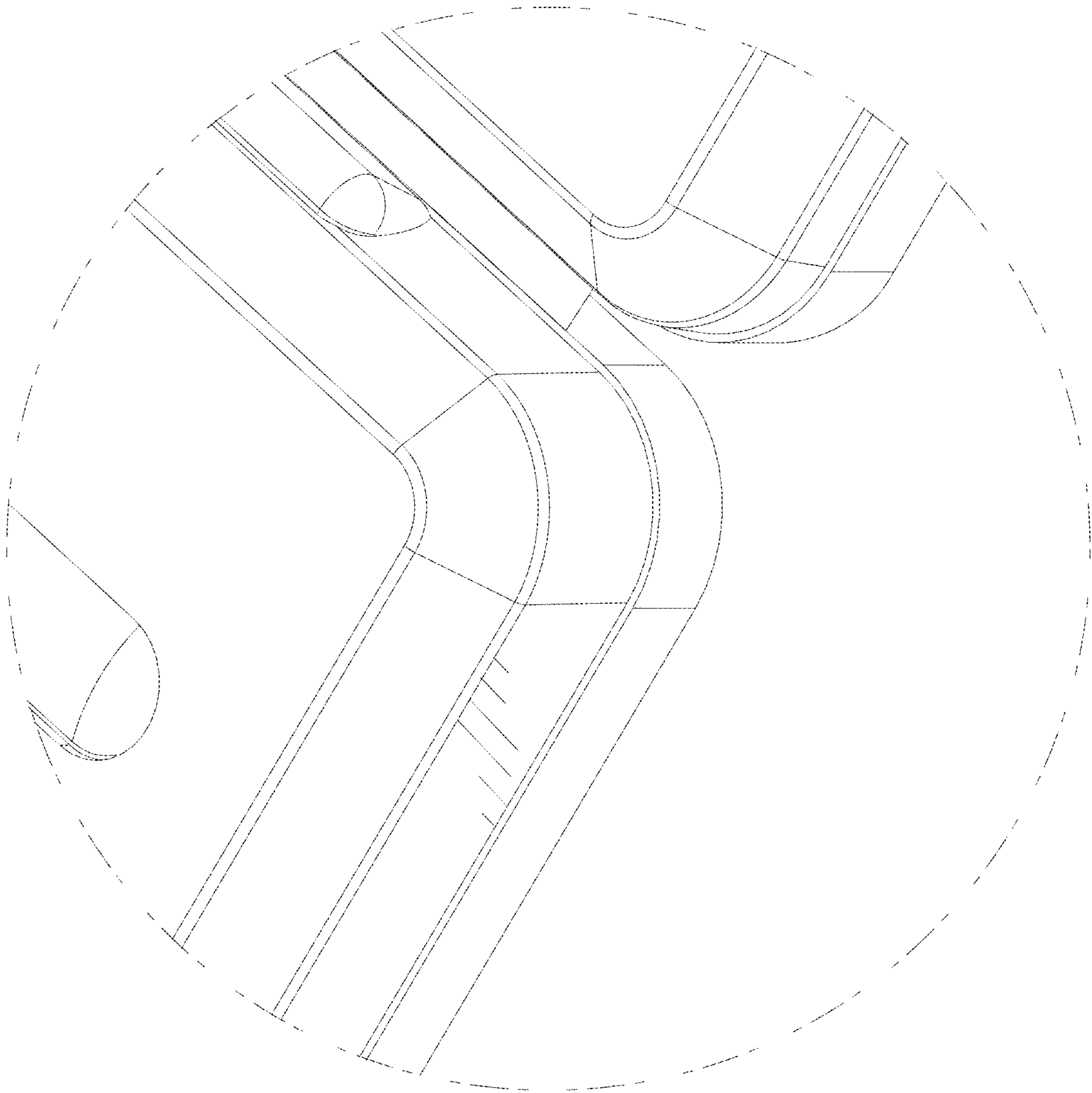

FIG. 10