



US00D970166S

(12) **United States Design Patent**
Han

(10) **Patent No.:** **US D970,166 S**

(45) **Date of Patent:** **** Nov. 22, 2022**

(54) **SHOE**

(71) Applicant: **NIKE, Inc.**, Beaverton, OR (US)

(72) Inventor: **Charles S. Han**, Portland, OR (US)

(73) Assignee: **NIKE, Inc.**, Beaverton, OR (US)

(**) Term: **15 Years**

(21) Appl. No.: **29/808,234**

(22) Filed: **Sep. 17, 2021**

(51) **LOC (13) Cl.** **02-04**

(52) **U.S. Cl.**
USPC **D2/947**

(58) **Field of Classification Search**
USPC D2/902, 906, 908, 916, 918, 925,
D2/946-962, 977
CPC A43B 13/00; A43B 13/02; A43B 13/023;
A43B 13/026; A43B 13/04; A43B 13/08;
A43B 13/10; A43B 13/12; A43B 13/14;
A43B 13/141; A43B 13/143; A43B
13/16; A43B 13/18; A43B 13/181; A43B
13/187; A43B 13/189; A43B 13/20; A43B
13/22; A43B 13/223; A43B 13/24; A43B
13/28; A43B 13/30; A43B 13/32; A43B
13/34; A43B 13/36

See application file for complete search history.

(56) **References Cited**

U.S. PATENT DOCUMENTS

D253,017 S	10/1979	Marchesi	
D279,232 S	6/1985	Gamm	
5,060,401 A	10/1991	Whatley	
D324,940 S *	3/1992	Claveria	D2/947
5,279,051 A	1/1994	Whatley	
D384,803 S	10/1997	Avar	
D401,744 S	12/1998	Greenberg	
D426,941 S *	6/2000	Geis	D2/904

D474,591 S *	5/2003	Clegg	D2/972
D544,698 S *	6/2007	Chang	D2/972
D561,984 S	2/2008	Truelsen	
D608,988 S	2/2010	Truelsen	
D608,989 S	2/2010	Truelsen	
D608,990 S	2/2010	Truelsen	
D679,899 S	4/2013	Taestensen	
D683,117 S	5/2013	Truelsen	
D702,028 S	4/2014	Truelsen	
D703,931 S	5/2014	Bikowski	
D716,535 S	11/2014	Seo	
D717,527 S	11/2014	Truelsen	
D740,004 S	10/2015	Hoellmueller et al.	
D740,528 S	10/2015	Hardman	

(Continued)

OTHER PUBLICATIONS

Nike React Infinity Run Flyknit 3, Nike.com, [online], [site visited Jul. 20, 2022]. <URL: <https://www.nike.com/t/react-infinity-run-flyknit-3-mens-road-running-shoes-1bRq75/DV0697-043>> (Year: 2022).*

(Continued)

Primary Examiner — Jonathan J Han

(74) *Attorney, Agent, or Firm* — Banner & Witcoff, Ltd.

(57) **CLAIM**

The ornamental design for a shoe, as shown and described.

DESCRIPTION

FIG. 1 is a side view of a shoe showing my new design; FIG. 2 is a rear perspective view thereof; FIG. 3 is a rear view thereof; FIG. 4 is an opposite side rear perspective view thereof; and, FIG. 5 is an opposite side view thereof. The broken lines showing the two racetrack shaped elements form no part of the claimed design. The broken lines depicting the remainder of the shoe form no part of the claimed design.

1 Claim, 5 Drawing Sheets

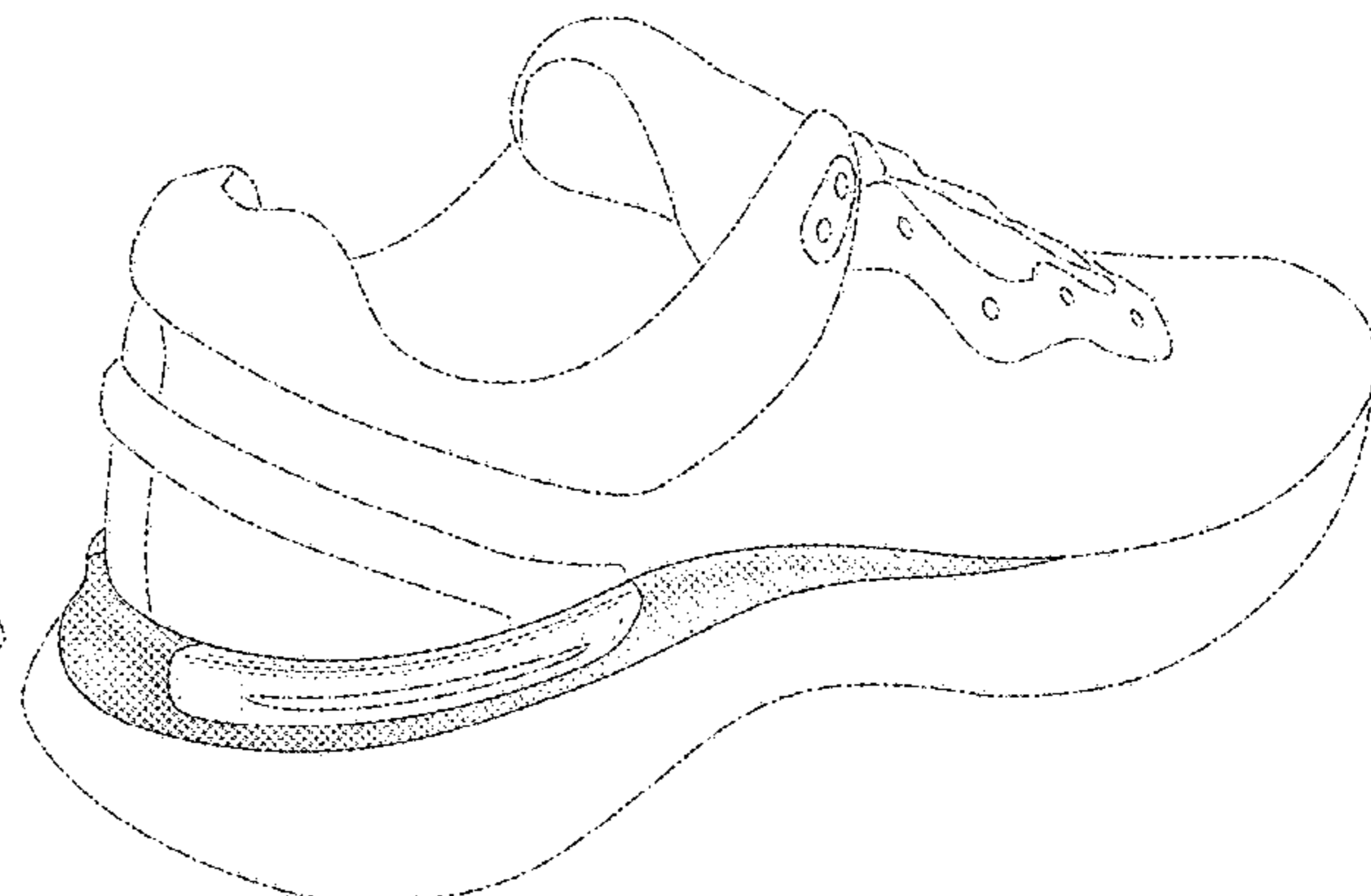
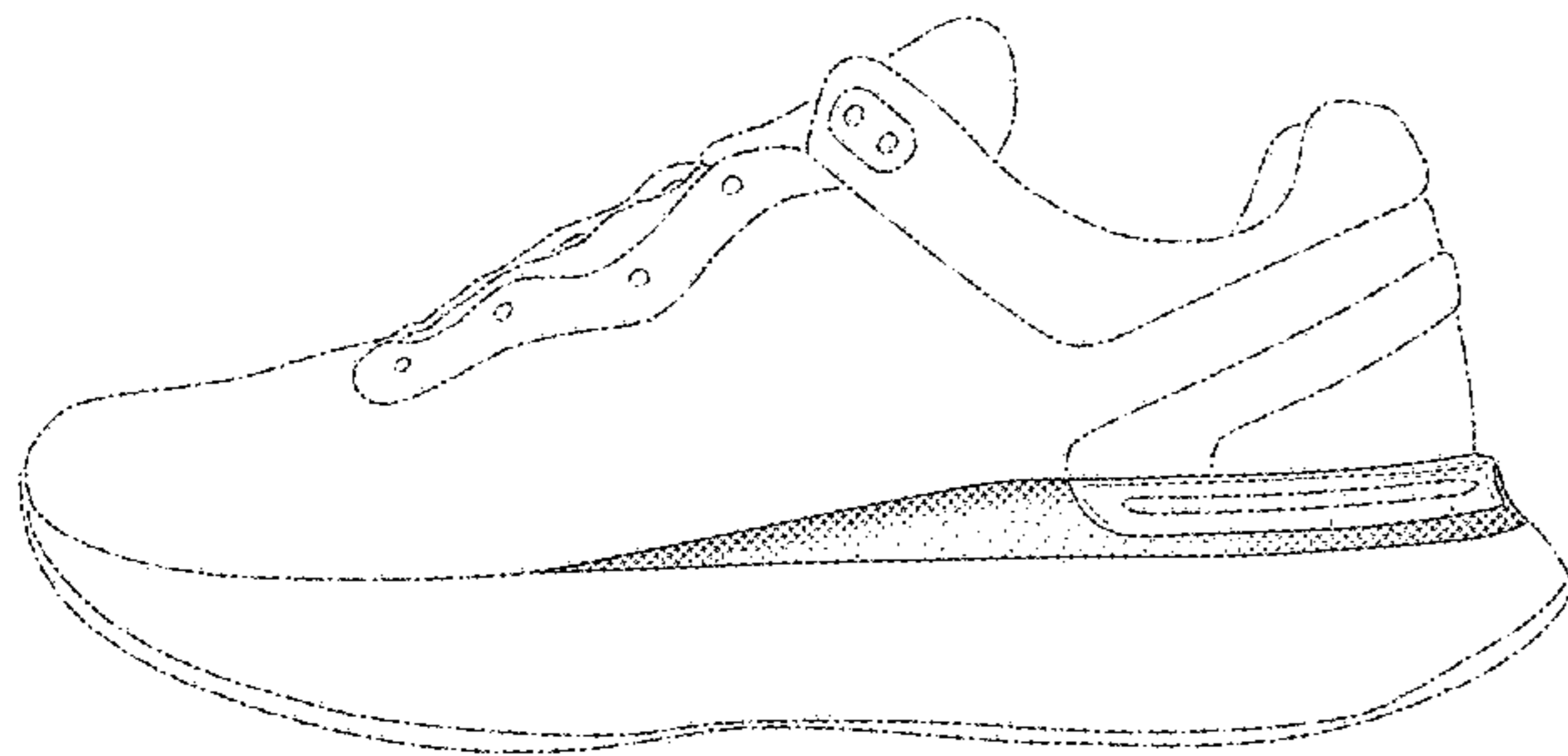

(56)

References Cited

U.S. PATENT DOCUMENTS

D740,530 S 10/2015 Truelsen
 D741,586 S 10/2015 Truelsen
 D746,561 S 1/2016 Bikowski
 D769,601 S * 10/2016 Hardman D2/972
 D783,255 S * 4/2017 Ando D2/972
 D796,813 S 9/2017 Link
 D802,280 S * 11/2017 Comeaux D2/972
 D816,972 S 5/2018 Pauk
 D819,311 S 6/2018 Jury et al.
 D823,566 S 7/2018 Kim et al.
 D829,432 S * 10/2018 Sokol D2/973
 D838,462 S * 1/2019 Enayah D2/972
 D838,463 S 1/2019 Durflinger
 D838,966 S * 1/2019 Pauk D2/972
 D840,658 S * 2/2019 Enayah D2/972
 D840,663 S 2/2019 Flanagan et al.
 D845,809 S 4/2019 Knapp
 D851,878 S 6/2019 Pauk
 D853,103 S 7/2019 Nethongkome
 D854,303 S 7/2019 Flanagan et al.
 D854,809 S * 7/2019 Hernandez D2/972
 D858,054 S 9/2019 McMillan
 D869,131 S 12/2019 Raasch
 D869,832 S * 12/2019 Seamarks D2/947
 D875,376 S 2/2020 Petrenka
 D876,798 S * 3/2020 Aden D2/947
 D882,916 S 5/2020 Pauk
 D882,917 S 5/2020 Young
 D882,933 S 5/2020 Van Atta
 D888,386 S 6/2020 Pauk
 D888,401 S 6/2020 Pauk
 D888,402 S 6/2020 Pauk
 D891,742 S 8/2020 Seamarks
 D891,744 S 8/2020 Han
 D891,745 S 8/2020 Han
 D892,479 S 8/2020 Han
 D893,165 S 8/2020 de Montgolfier
 D895,240 S * 9/2020 Schultze D2/947
 D895,245 S 9/2020 Hardigan
 D899,063 S 10/2020 Panian
 D899,755 S * 10/2020 Hatfield D2/972
 D905,950 S * 12/2020 Winfield D2/972
 D905,952 S * 12/2020 Winfield D2/972
 D906,649 S 1/2021 Odinet et al.
 D906,651 S 1/2021 O'Connor
 D907,342 S 1/2021 Odinet et al.
 D908,337 S 1/2021 Troufanov
 D909,020 S 2/2021 Gvasalia
 D910,986 S 2/2021 Durflinger
 D911,016 S 2/2021 Richez et al.
 D912,374 S 3/2021 Herga et al.
 D912,967 S 3/2021 Han et al.
 D915,055 S * 4/2021 Herath D2/972
 D918,550 S 5/2021 Amago
 D929,087 S 8/2021 Gerig
 D929,107 S * 8/2021 de Montgolfier D2/972
 D943,899 S * 2/2022 Hoang D2/947
 D943,946 S * 2/2022 Cheney D2/947
 D943,950 S * 2/2022 Parrett D2/972
 D948,191 S * 4/2022 Holmes D2/968

D949,544 S * 4/2022 Witherow D2/972
 D950,228 S * 5/2022 de Montgolfier D2/972
 D953,711 S * 6/2022 Han D2/947
 11,369,162 B2 * 6/2022 Chan A43B 23/0295

OTHER PUBLICATIONS

Nike Air Max Dawn, Nike.com, [online], [site visited Jul. 20, 2022].
 <URL: <https://www.nike.com/t/air-max-dawn-mens-shoes-Rg69GM/DJ3624-400>> (Year: 2022).*

“Nike Epic React Coming Soon in White and Pink”; Sneaker News; retrieved Sep. 16, 2021; published Apr. 25, 2018; URL: <<https://sneakernews.com/2018/04/25/nike-epic-react-white-pink-release-info/>>.

“Nike’s Upcoming Infinity React Run Gets a Clean Grey Option”; Sneaker News; retrieved Sep. 16, 2021; published Dec. 15, 2019; URL: <<https://sneakernews.com/2019/12/15/nikes-infinity-react-run-cd4371-003-release-info/>>.

“Nike React Miler 2 Arrives in “Chlorine Blue””; Sneaker Bar Detroit; retrieved Sep. 16, 2021; published Apr. 20, 2021; URL: <<https://sneakerbardetroit.com/nike-react-miler-2-chlorine-blue-cw7121-003-release-date/>>.

“Nike React Miler”; Nike; retrieved Sep. 16, 2021; published date unknown, but prior to application filing date; URL: <<https://www.nike.com/t/react-miler-mens-running-shoes-DgF6nr>>.

Nike Footwear Catalog, 1990 Fall Footwear, p. 82, published Dec. 1989, Nike, Inc., USA.

Nike Footwear Catalog, 1999 Spring Men’s Specialty and Women’s & Kids’ Footwear, p. M24, published Mar. 1999, Nike, Inc., USA.

Nike Footwear Catalog, 2000 Fall Men’s and Women’s Footwear (red cover), p. M24, published Nov. 1999, Nike, Inc., USA.

Nike Footwear Catalog, 2005 Fall Footwear, p. M16, published Nov. 2003, Nike, Inc., USA.

Nike Footwear Catalog, 2007 Fall Footwear, p. 152, published Nov. 2005, Nike, Inc., USA.

Nike Footwear Catalog, 2007 Fall Footwear, p. 168, published Nov. 2005, Nike, Inc., USA.

Nike Footwear Catalog, 2007 Spring Footwear, p. 21, published Jun. 2006, Nike, Inc., USA.

Nike Footwear Catalog, 2007 Spring Footwear, p. 29, published Jun. 2006, Nike, Inc., USA.

Nike Footwear Catalog, 2012 Fall Men’s Footwear Sportswear Best, p. 12, published Nov. 2010, Nike, Inc., USA.

Nike Footwear Catalog, 2013 Fall Mens Performance Footwear, p. 11, published Feb. 2012, Nike, Inc., USA.

Nike Footwear Catalog, 2014 Fall City Specialty Footwear Best Final, p. 132, published Feb. 2013, Nike, Inc., USA.

Nike Footwear Catalog, 2014 Fall City Specialty Footwear Best Final, p. 14, published Feb. 2013, Nike, Inc., USA.

Nike Footwear Catalog, 2014 Fall Sporting Goods Footwear Best, p. 119, published Feb. 2013, Nike, Inc., USA.

Nike Footwear Catalog, 2015 Spring Women’s Performance Footwear, p. 38, published Nov. 2014, Nike, Inc., USA.

Nike Footwear Catalog, 2015 Spring Women’s Performance Footwear, p. 7, published Nov. 2014, Nike, Inc., USA.

Nike Footwear Catalog, 2017 Spring Department Stores Footwear Better, p. 41, published May 2016, Nike, Inc., USA.

* cited by examiner

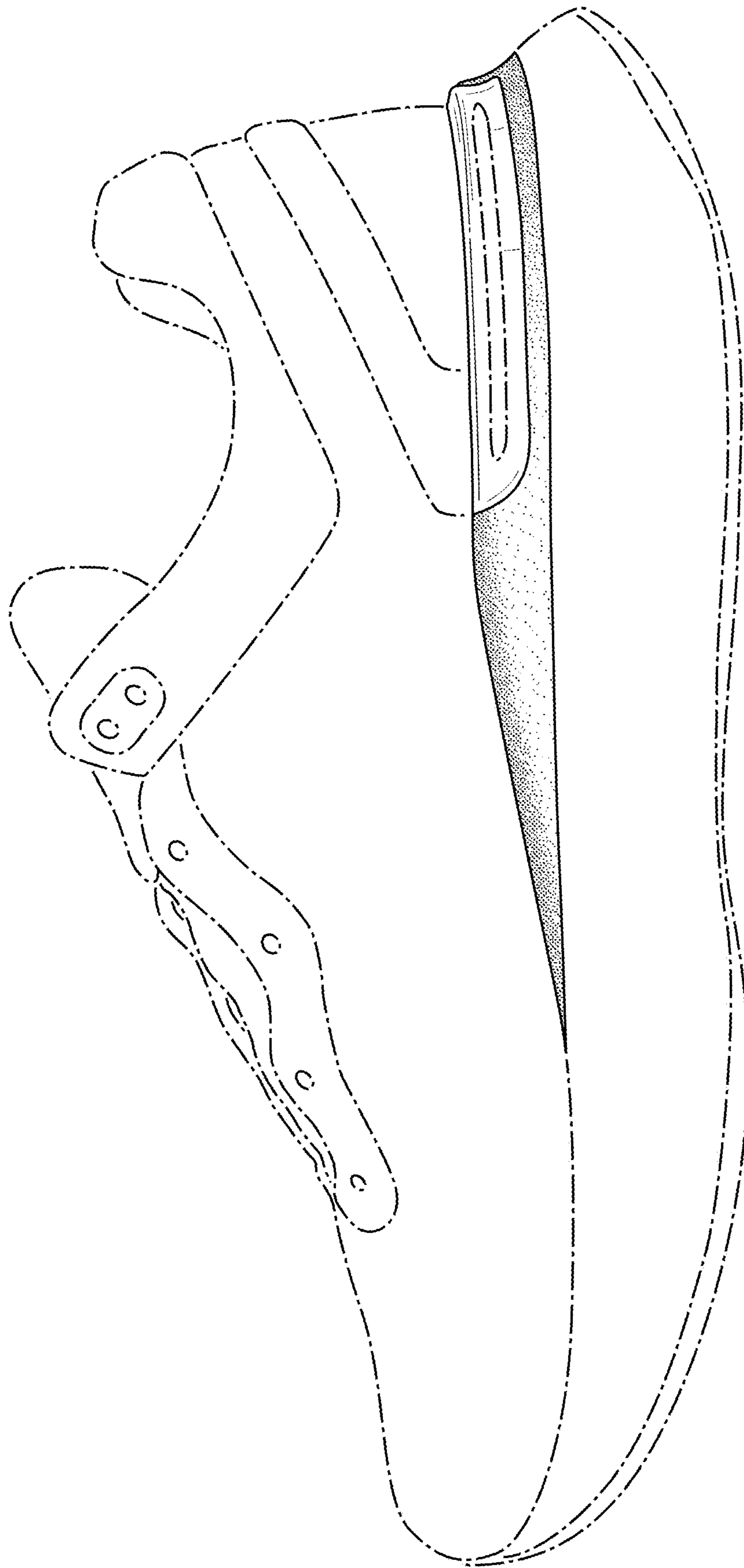

FIG. 1

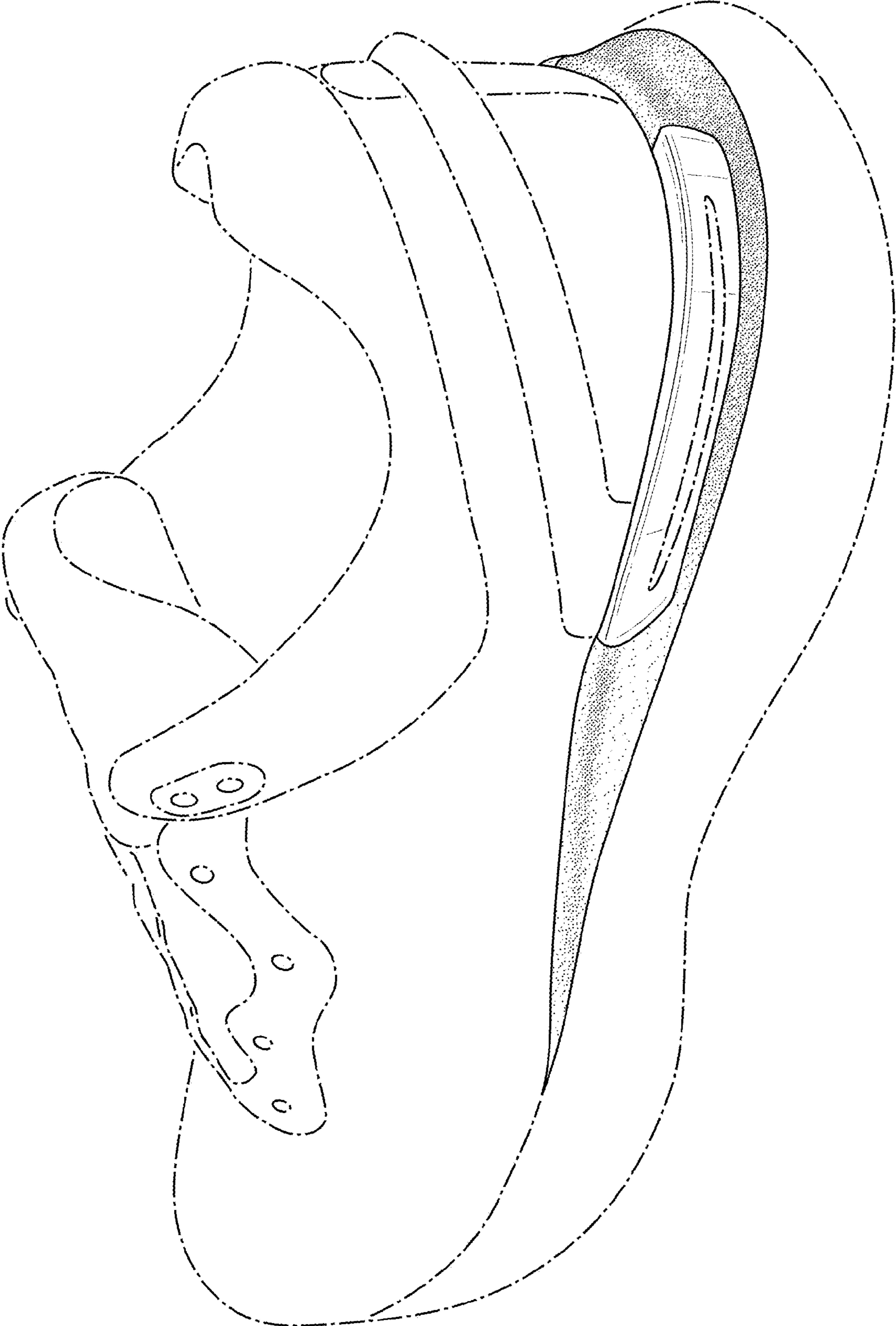

FIG. 2

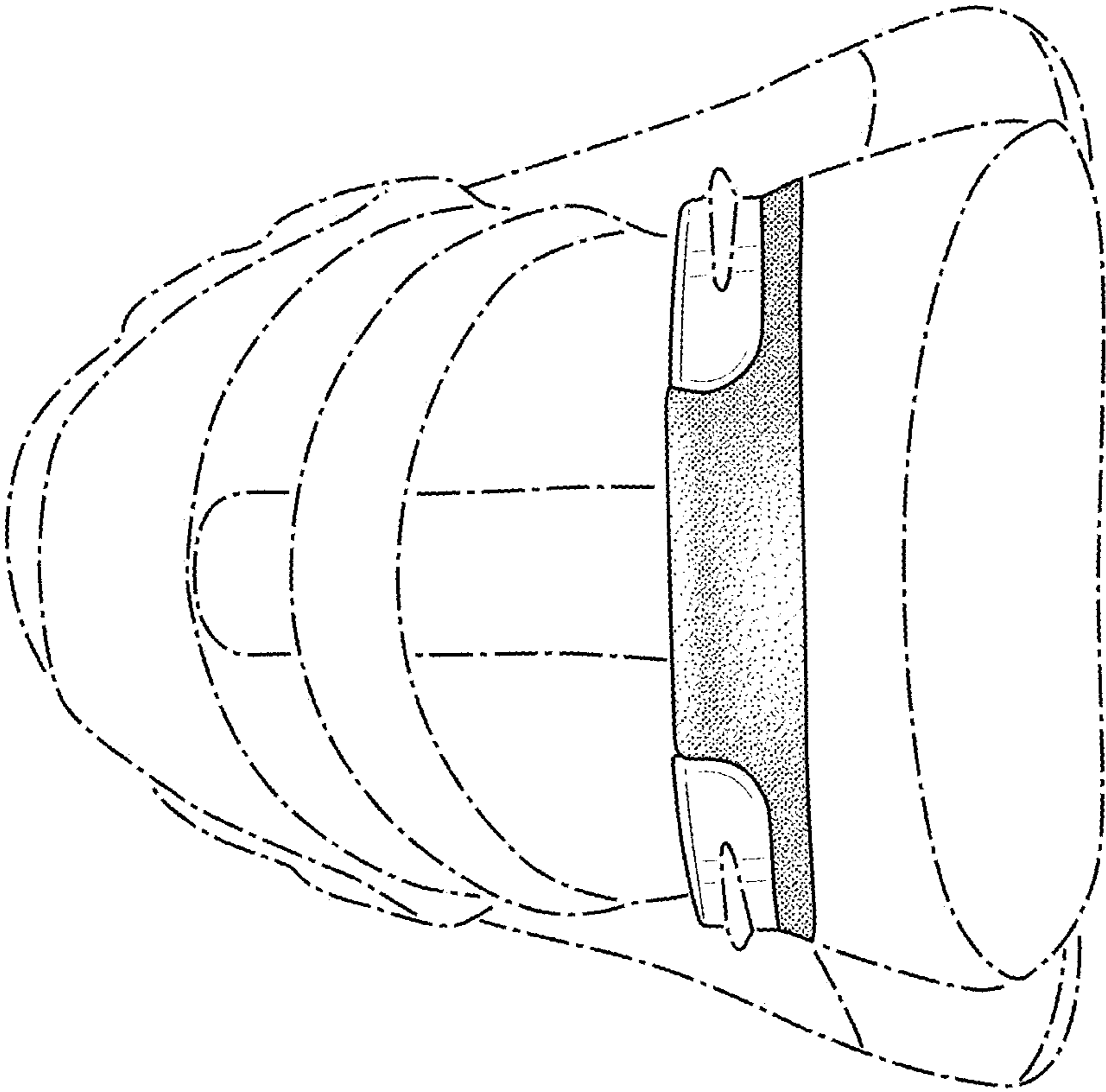

FIG. 3

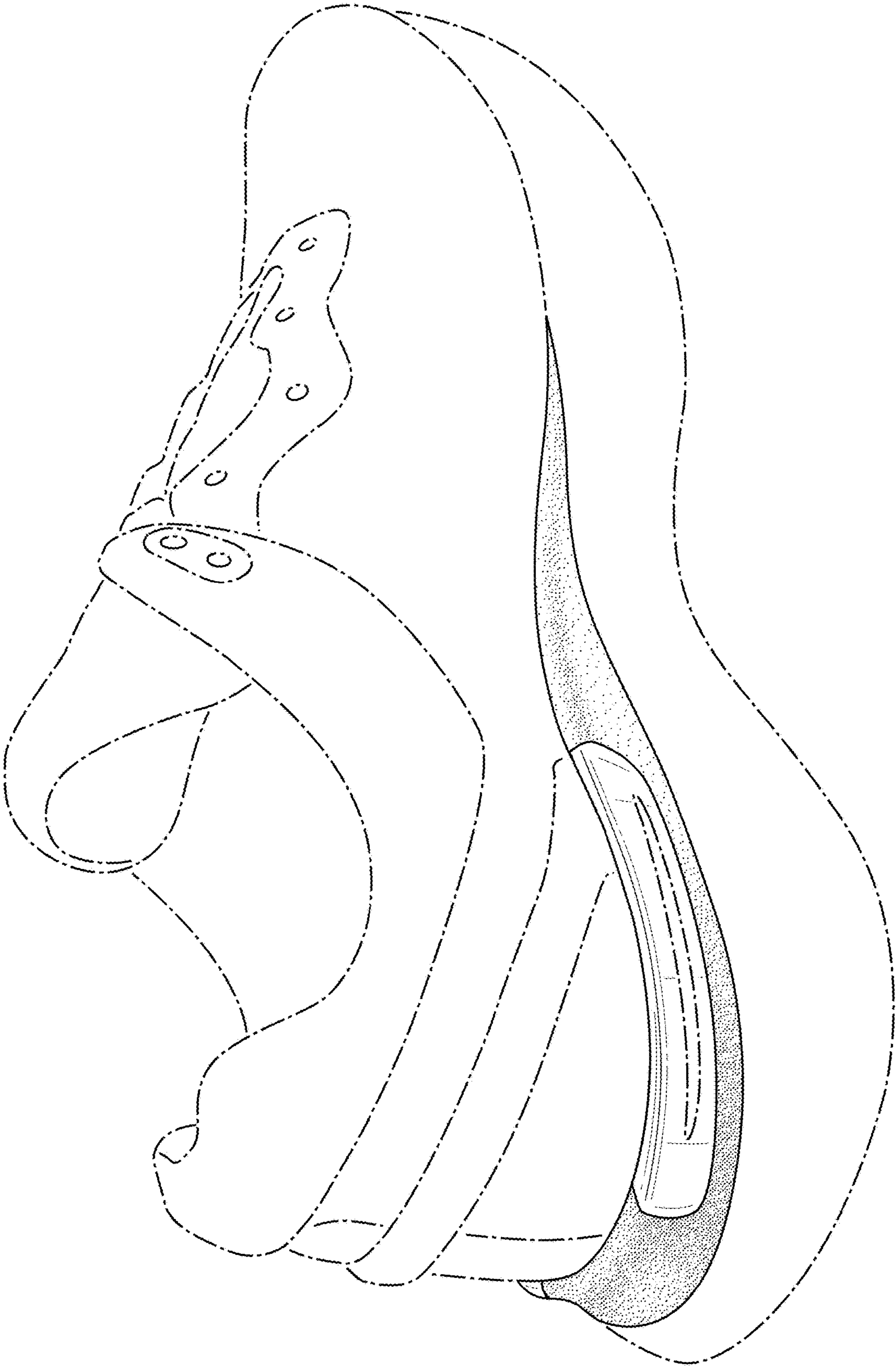

FIG. 4

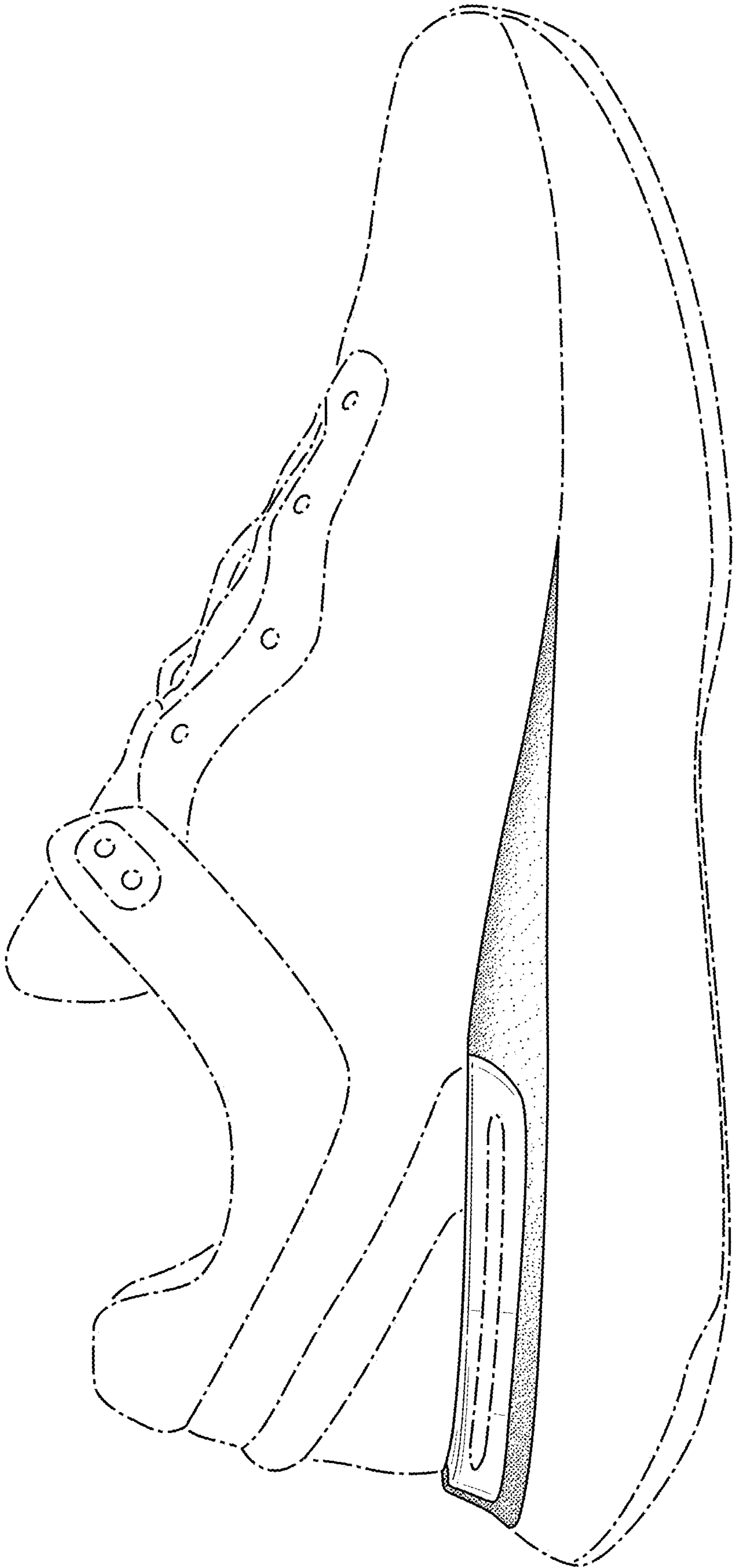

FIG. 5