

US00D970162S

(12) **United States Design Patent**
Xu

(10) **Patent No.:** **US D970,162 S**

(45) **Date of Patent:** **** Nov. 22, 2022**

(54) **FOOT WARMER**

(71) Applicant: **Zhifeng Xu**, Shenzhen (CN)

(72) Inventor: **Zhifeng Xu**, Shenzhen (CN)

(**) Term: **15 Years**

(21) Appl. No.: **29/846,311**

(22) Filed: **Jul. 15, 2022**

(51) **LOC (13) Cl.** **02-04**

(52) **U.S. Cl.**

USPC **D2/919**; D2/921

(58) **Field of Classification Search**

USPC D2/896, 910, 919, 970, 921, 946, 900;
D24/192

CPC A43B 3/101; A43B 3/102; A61F 7/0085;
A41D 15/04; A45C 9/00

See application file for complete search history.

(56) **References Cited**

U.S. PATENT DOCUMENTS

- 1,608,188 A * 11/1926 Skoler A61F 7/0085
36/2.6
- 1,613,321 A * 1/1927 Giroux A43B 3/101
36/16
- 1,686,588 A * 10/1928 Wendemuth A61F 7/0085
36/2.6
- 1,746,459 A * 2/1930 Brady A61F 7/0085
36/7.1 R
- 1,776,983 A * 9/1930 Rotherham A45C 9/00
383/30
- 1,808,233 A * 6/1931 Kamrath A61F 7/0085
2/69

D244,641 S * 6/1977 Rajaniemi A61F 7/0085
D2/910

D268,298 S * 3/1983 Goguen A61F 7/0085
D2/912

5,561,859 A * 10/1996 Fischer A45C 9/00
2/69.5

D427,419 S * 7/2000 Tenold A61F 7/0085
D2/910

D677,864 S 3/2013 Cornett et al.

D732,280 S * 6/2015 Hershberger D2/919

D764,065 S 8/2016 Schaberreiter et al.

D922,738 S * 6/2021 McColm D2/921

* cited by examiner

Primary Examiner — Rashida C. Walshon

(74) *Attorney, Agent, or Firm* — Georgi Korobanov

(57) **CLAIM**

The ornamental design for a foot warmer, as shown and described.

DESCRIPTION

FIG. 1 is a perspective view of a foot warmer, showing my new design;

FIG. 2 is another perspective view thereof;

FIG. 3 is a front view thereof;

FIG. 4 is a rear view thereof;

FIG. 5 is a left side view thereof;

FIG. 6 is a right side view thereof;

FIG. 7 is a top plan view thereof; and,

FIG. 8 is a bottom plan view thereof.

The broken line showing of the foot warmer is for the purpose of illustrating article and forms no part of the claimed design.

1 Claim, 8 Drawing Sheets

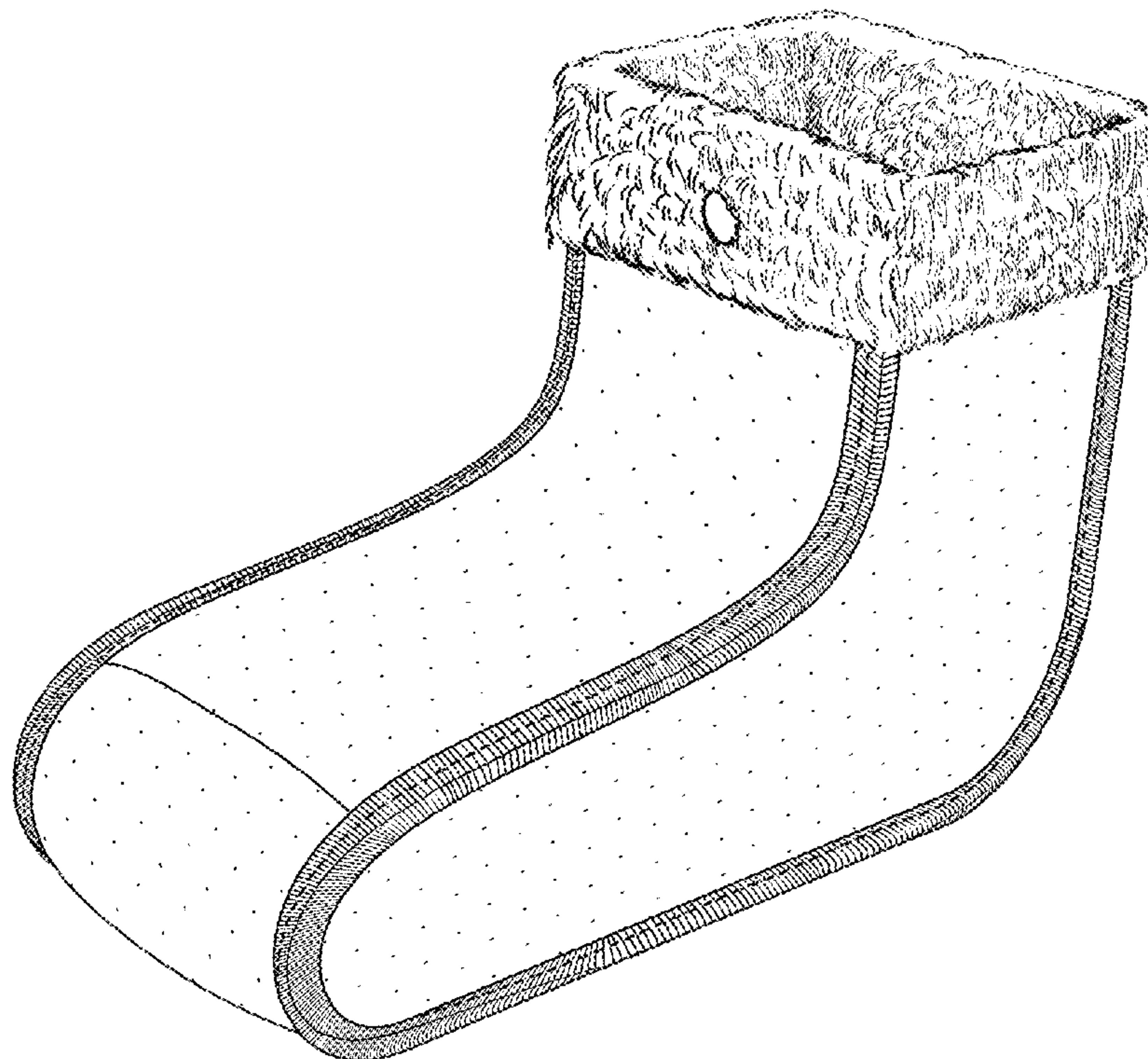

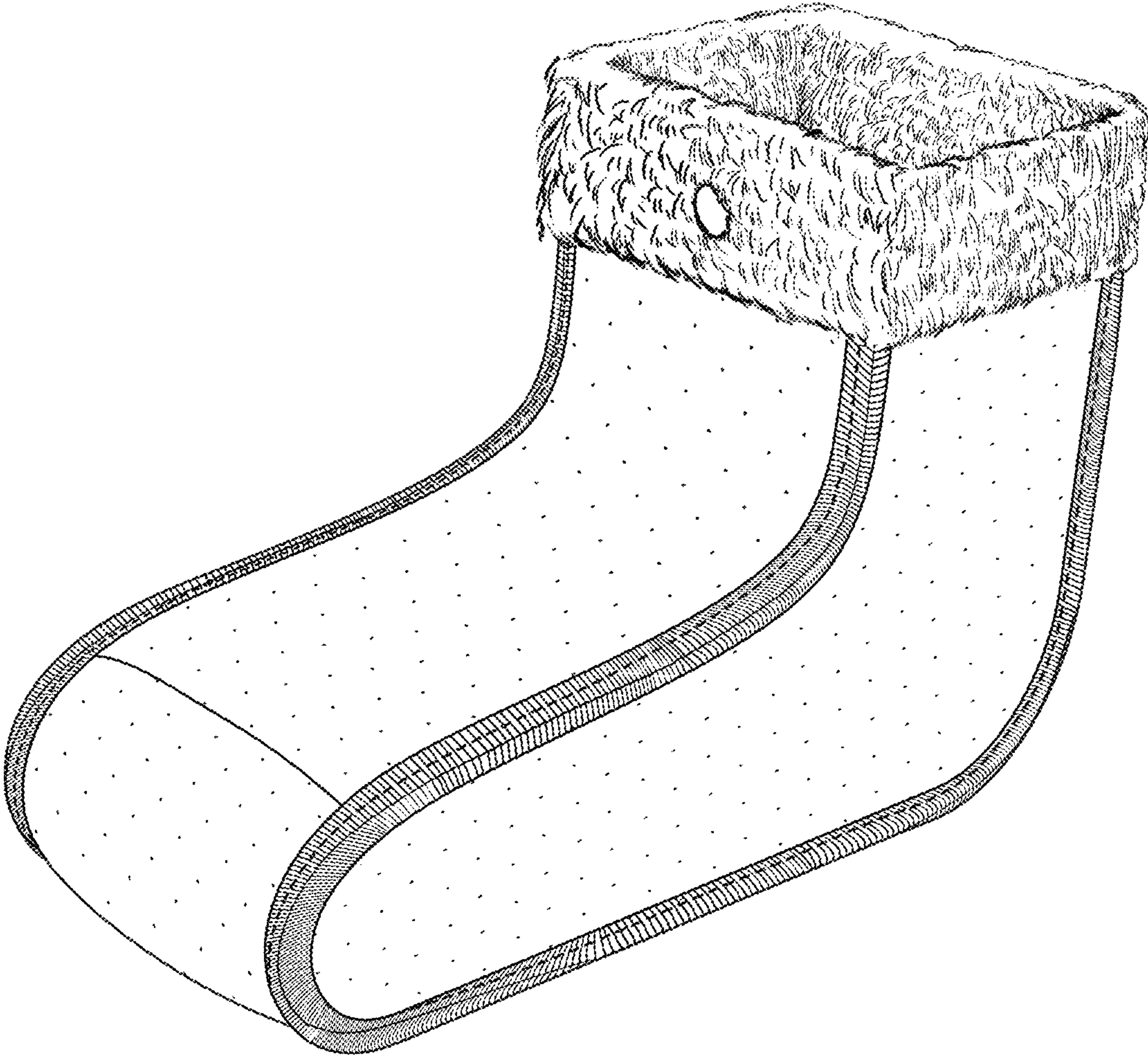

FIG. 1

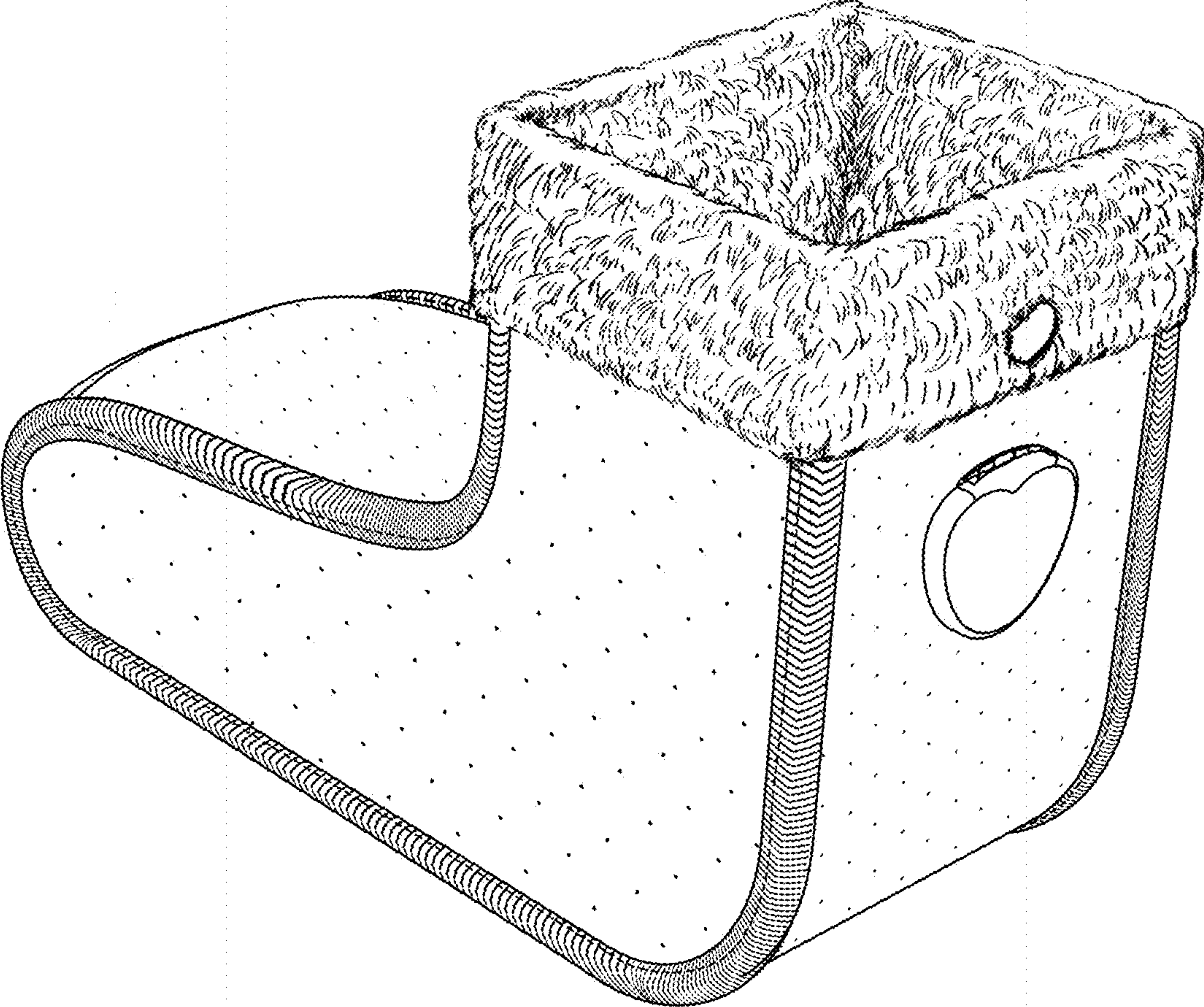

FIG. 2

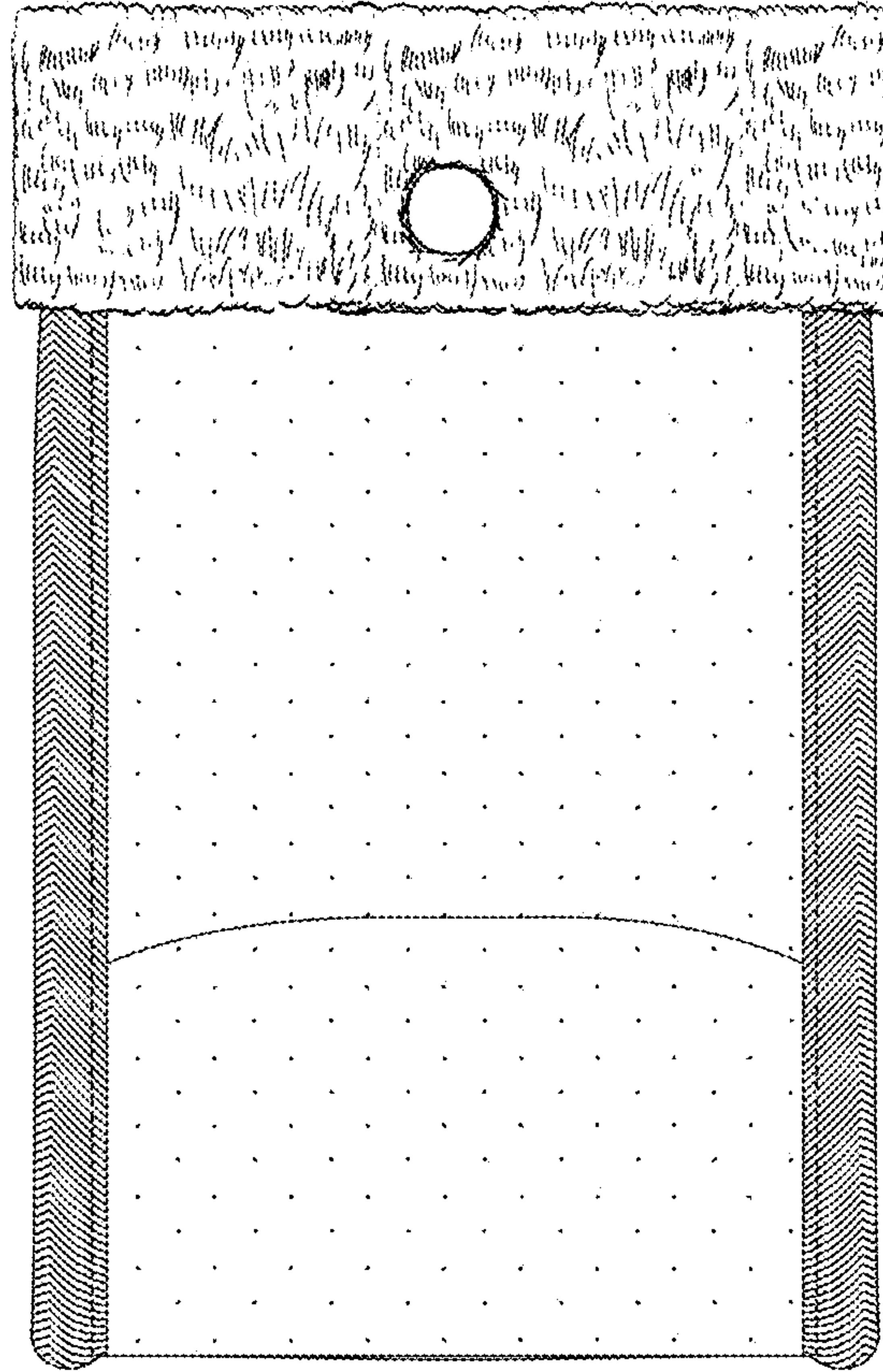

FIG. 3

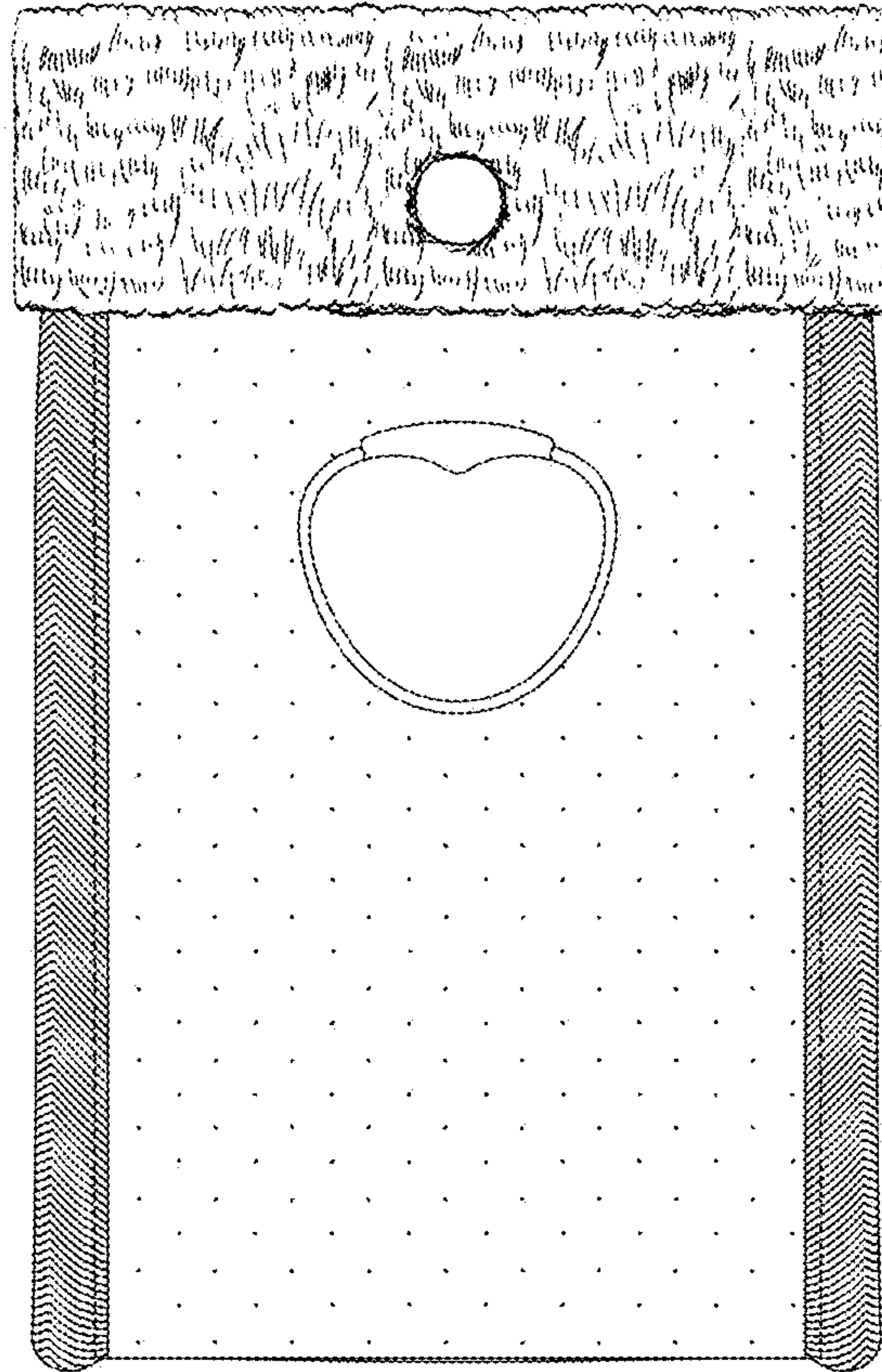

FIG. 4

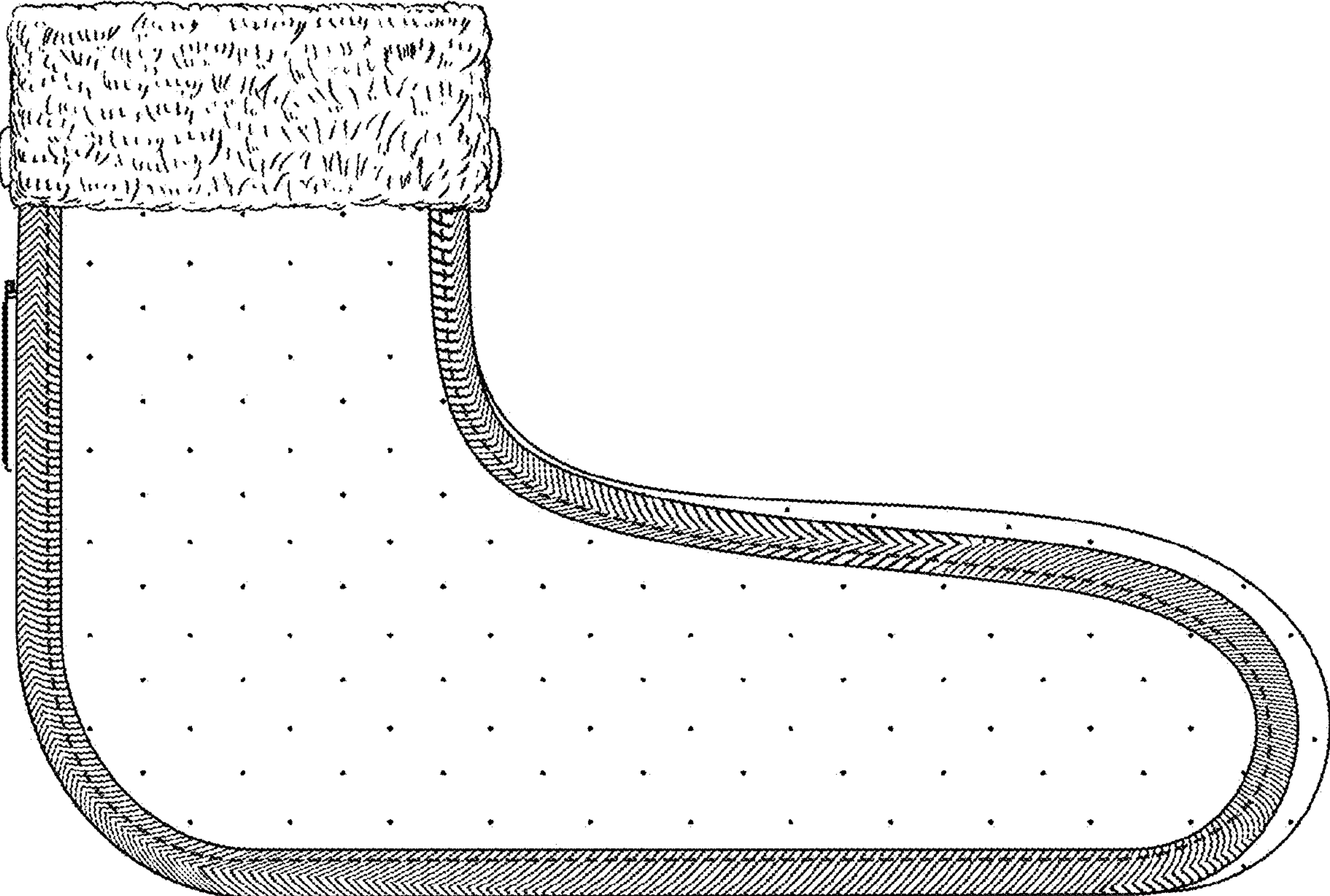

FIG. 5

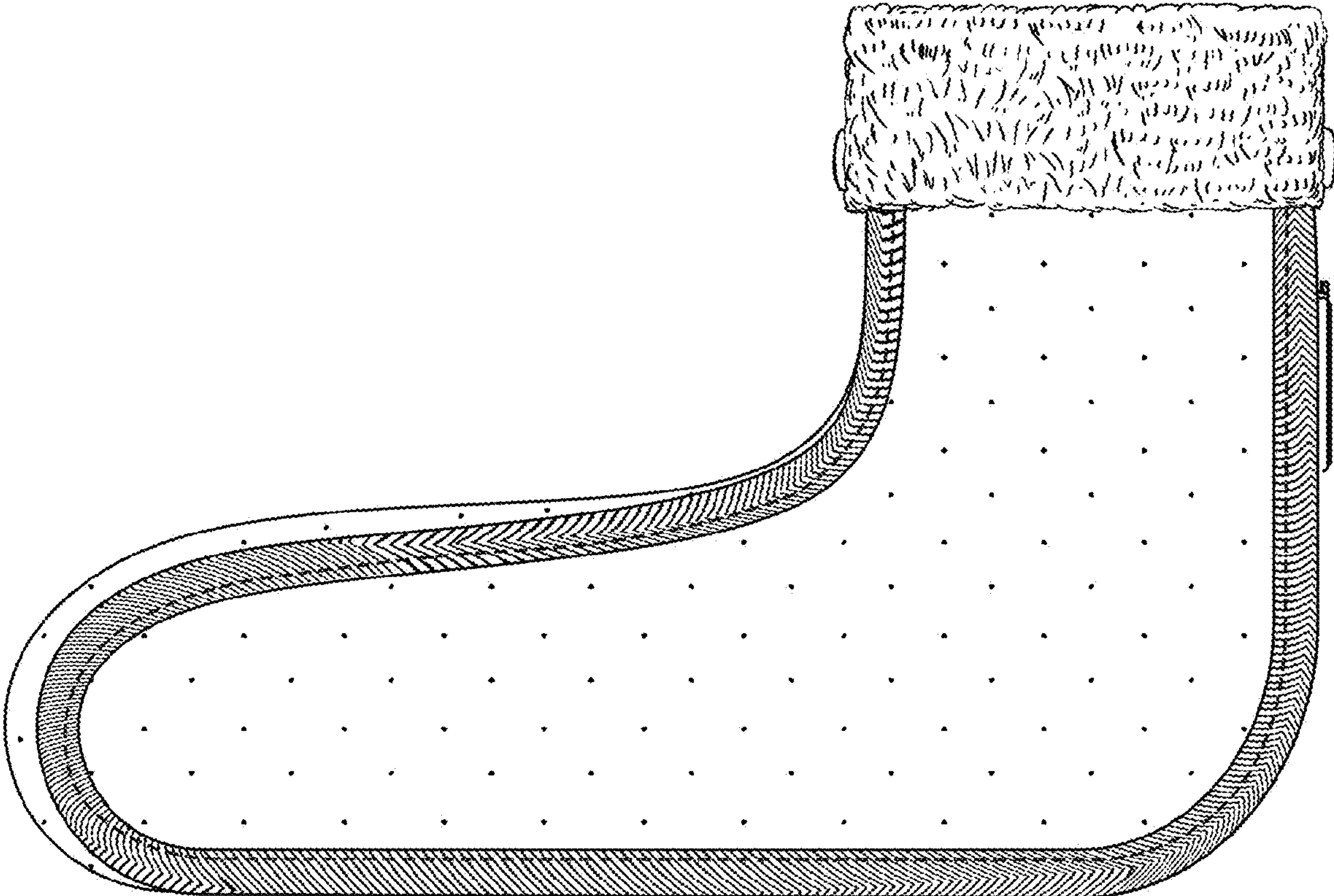

FIG. 6

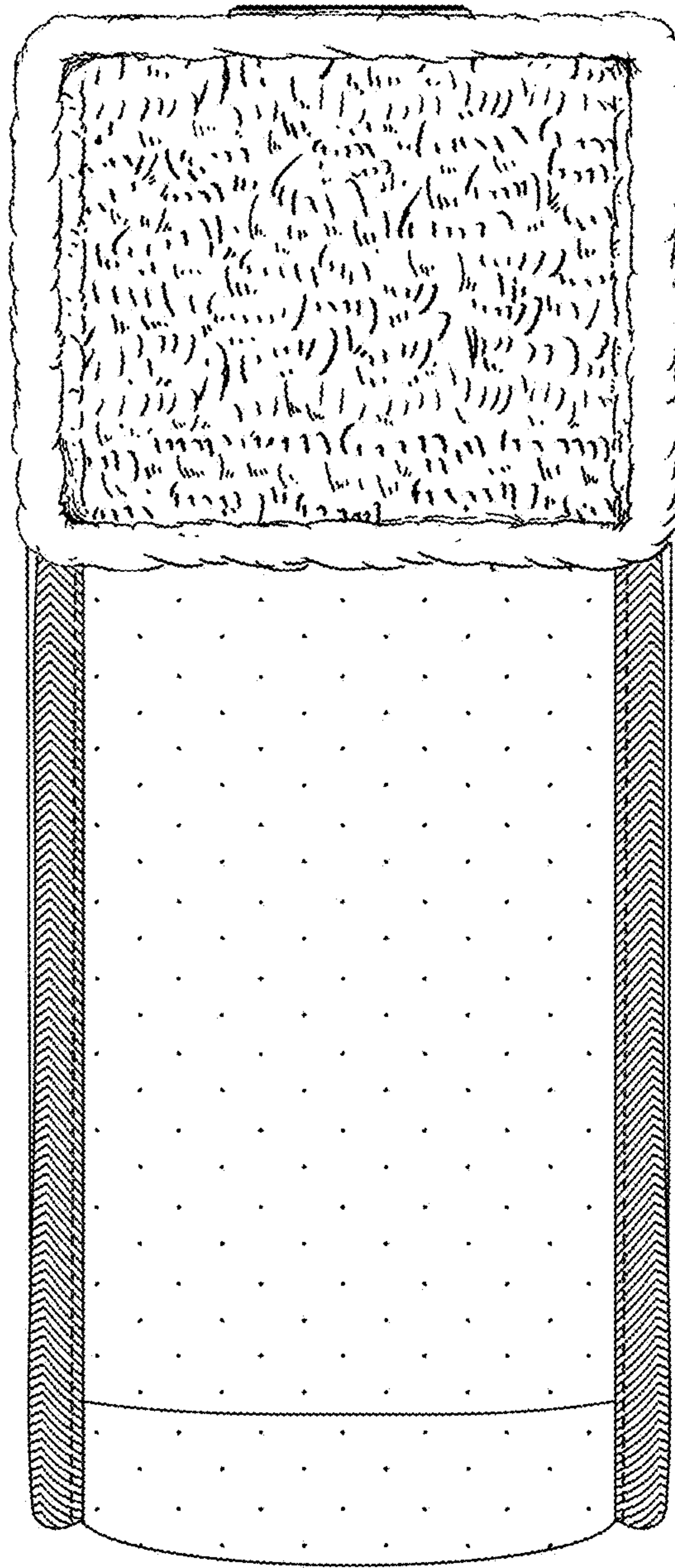

FIG. 7

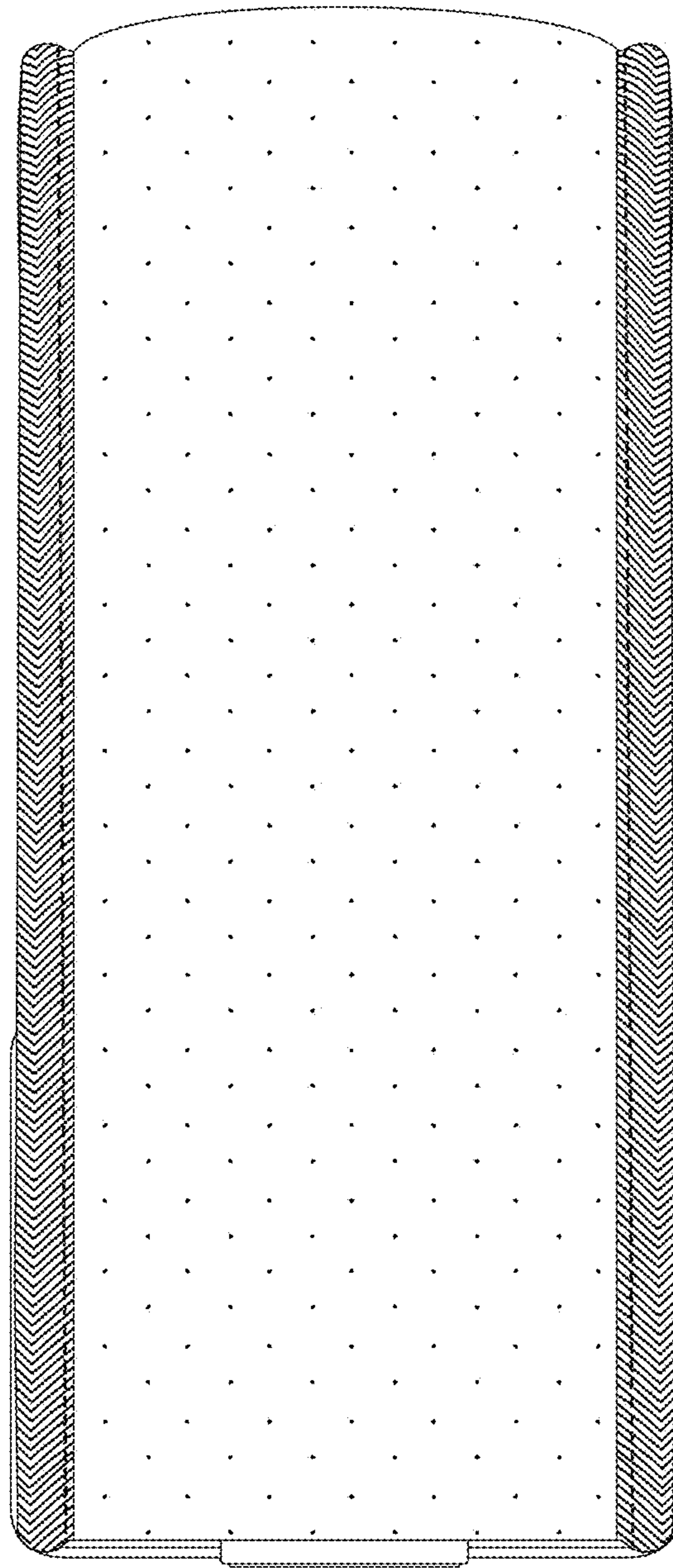

FIG. 8