



US00D970051S

(12) **United States Design Patent**
Rashid

(10) **Patent No.:** **US D970,051 S**

(45) **Date of Patent:** **** Nov. 15, 2022**

(54) **ROOF SUPPORT STRUCTURE WITH PERIPHERAL SUPPORT STRAP GROOVES**

(74) *Attorney, Agent, or Firm* — Edmund P. Anderson; North Star IP Law PLLC

(71) Applicant: **Phil Squared Roof Jack Systems LLC**, Highland, MI (US)

(57) **CLAIM**

(72) Inventor: **Philip F Rashid**, Brighton, MI (US)

The ornamental design for a roof support structure with peripheral support strap grooves, as shown and described.

(73) Assignee: **Phil Squared Roof Jack Systems LLC**, Highland, MI (US)

DESCRIPTION

(**) Term: **15 Years**

(21) Appl. No.: **29/834,050**

(22) Filed: **Apr. 8, 2022**

FIG. 1 is a perspective view of an embodiment of a roof support structure with peripheral support strap grooves comprising an upper core member and a plurality of attached lower cover layer members comprising an elastomeric polymer foam;

Related U.S. Application Data

(62) Division of application No. 29/759,416, filed on Nov. 23, 2020, now Pat. No. Des. 948,753.

(51) **LOC (13) Cl.** **25-01**

(52) **U.S. Cl.**
USPC **D25/133**

(58) **Field of Classification Search**
USPC D25/119, 125, 126, 127, 128, 129, 130, D25/131, 132, 133, 134, 135, 136
(Continued)

FIG. 2 is a top view thereof;

FIG. 3 is a bottom view thereof;

FIG. 4 is a left side view thereof;

FIG. 5 is a right side view thereof;

FIG. 6 is a front view thereof;

FIG. 7 is a rear view thereof;

FIG. 8 is a perspective view of a second embodiment of a roof support structure with peripheral support strap grooves comprising an upper core member and an attached lower cover layer member comprising an elastomeric polymer foam;

FIG. 9 is a top view thereof;

FIG. 10 is a bottom view thereof;

FIG. 11 is a left side view thereof;

FIG. 12 is a right side view thereof;

FIG. 13 is a front view thereof; and,

FIG. 14 is a rear view thereof.

References Cited

U.S. PATENT DOCUMENTS

341,950 A 5/1886 Sharpe
1,586,038 A 5/1926 Hall

(Continued)

The roof support structure with peripheral support strap grooves is shown with a symbolic break in its length. The appearance of any portion of the article between the break lines forms no part of the claimed design.

FOREIGN PATENT DOCUMENTS

EP 0710457 A2 5/1996
FR 2964985 A1 3/2012

(Continued)

The roof support structure with peripheral support strap grooves includes integral right end and left end pockets comprising handles or grips and a plurality of upwardly protruding traction members that are shown in broken lines. The broken lines shown in FIGS. 1-2, 4-9, and 11-14

Primary Examiner — Samantha Q Lawrence

(Continued)

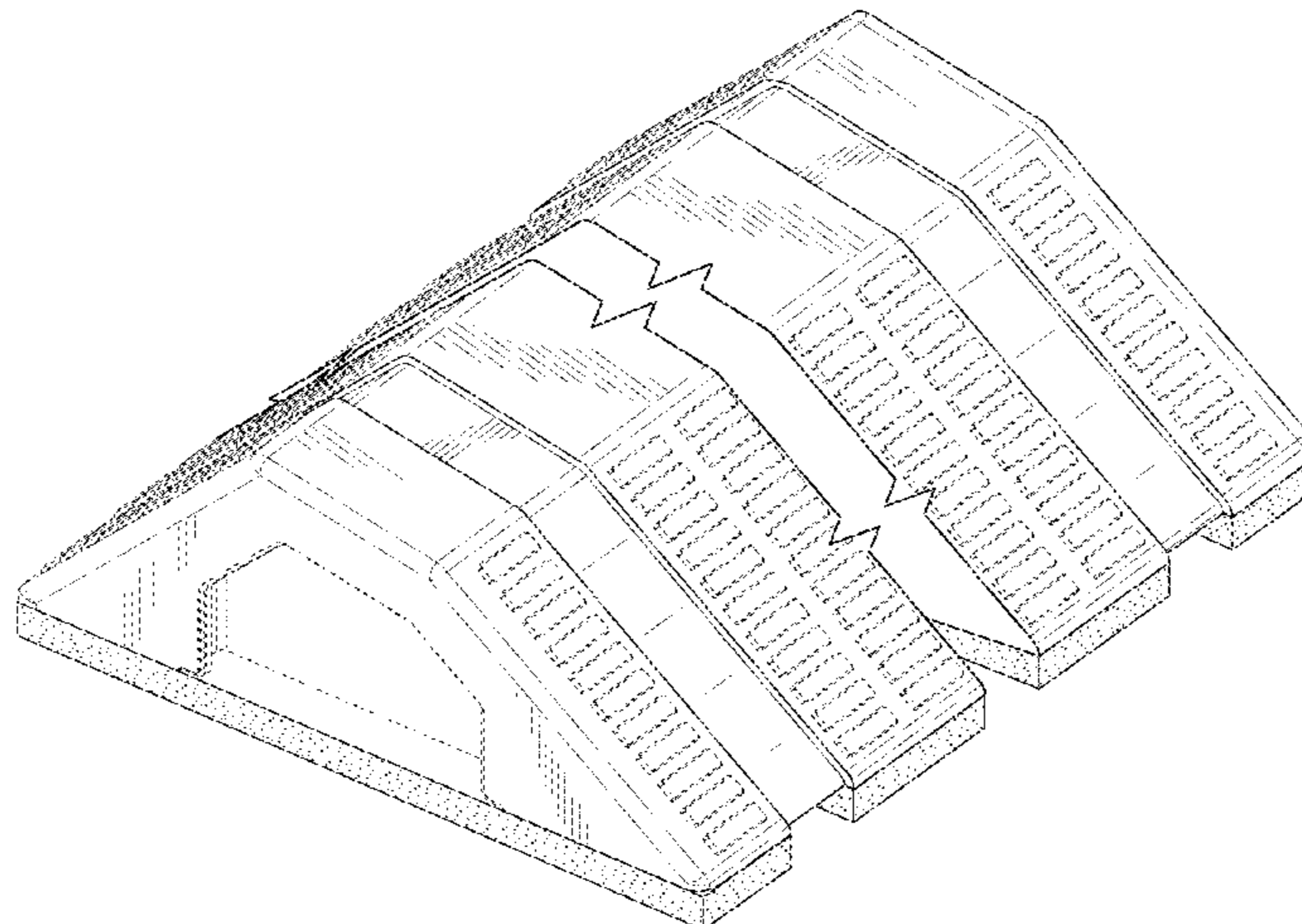

illustrate portions of the roof support structure with peripheral support strap grooves that form no part of the claimed design.

1 Claim, 10 Drawing Sheets

(58) **Field of Classification Search**

CPC E04D 15/02; E04D 15/00; E04D 13/12;
E04G 3/26; E04G 3/265; E04G 21/166;
E04G 3/34; A47B 91/12; A47B 91/024
See application file for complete search history.

(56) **References Cited**

U.S. PATENT DOCUMENTS

4,135,335	A	1/1979	Jensen	
4,519,565	A	5/1985	Whitmore	
4,830,320	A	5/1989	Bellows	
5,232,187	A	8/1993	O'Farrell et al.	
5,263,551	A	11/1993	Andersen	
5,715,910	A	2/1998	Koch et al.	
5,842,746	A *	12/1998	Rogers	A47C 31/10 297/219.1
5,887,406	A	3/1999	Bond	
5,943,839	A	8/1999	Miller	
6,170,222	B1	1/2001	Miller	
6,513,625	B1 *	2/2003	Gaskins	E06C 7/488 182/206
6,622,960	B2	9/2003	Hyde	
D596,812	S	7/2009	Sicken et al.	
8,104,575	B1	1/2012	Bancroft	
8,448,746	B2	5/2013	Davis	
9,145,687	B1	9/2015	Bancroft	

D743,628	S	11/2015	Millington	
D762,306	S	7/2016	Torres et al.	
9,834,937	B2	12/2017	Warner	
D809,799	S	2/2018	Pietruszewski et al.	
D821,959	S	7/2018	Baker	
10,206,511	B2	2/2019	Peters	
10,550,588	B2 *	2/2020	Smith	E04G 21/166
10,662,707	B2	5/2020	Koeman	
D892,193	S *	8/2020	Masuda	D16/208
10,844,616	B2	11/2020	Rashid et al.	
D948,753	S *	4/2022	Rashid	D25/133
D948,754	S *	4/2022	Rashid	D25/133
D960,396	S *	8/2022	Rashid	D25/133
2003/0037990	A1 *	2/2003	Testa, Jr.	E06C 1/52 248/237
2004/0144815	A1	7/2004	Reid	
2004/0221524	A1	11/2004	Poddany et al.	
2004/0262467	A1	12/2004	Burr	
2006/0226310	A1	10/2006	Hall et al.	
2007/0069088	A1	3/2007	Bidiville et al.	
2009/0151039	A1	6/2009	Kielland	
2009/0249740	A1	10/2009	Crookston	
2010/0127002	A1	5/2010	Bel	
2012/0080264	A1	4/2012	Lord	
2012/0085590	A1	4/2012	Davis	
2014/0116804	A1	5/2014	Bancroft	
2015/0021452	A1	1/2015	Bourbonnais	
2018/0334814	A1	11/2018	Rashid et al.	
2019/0218799	A1	7/2019	Smith et al.	
2020/0370315	A1	11/2020	Pollock	
2021/0388619	A1	12/2021	Pollock	

FOREIGN PATENT DOCUMENTS

WO	2022164619	A1	8/2022
WO	2022186900	A1	9/2022

* cited by examiner

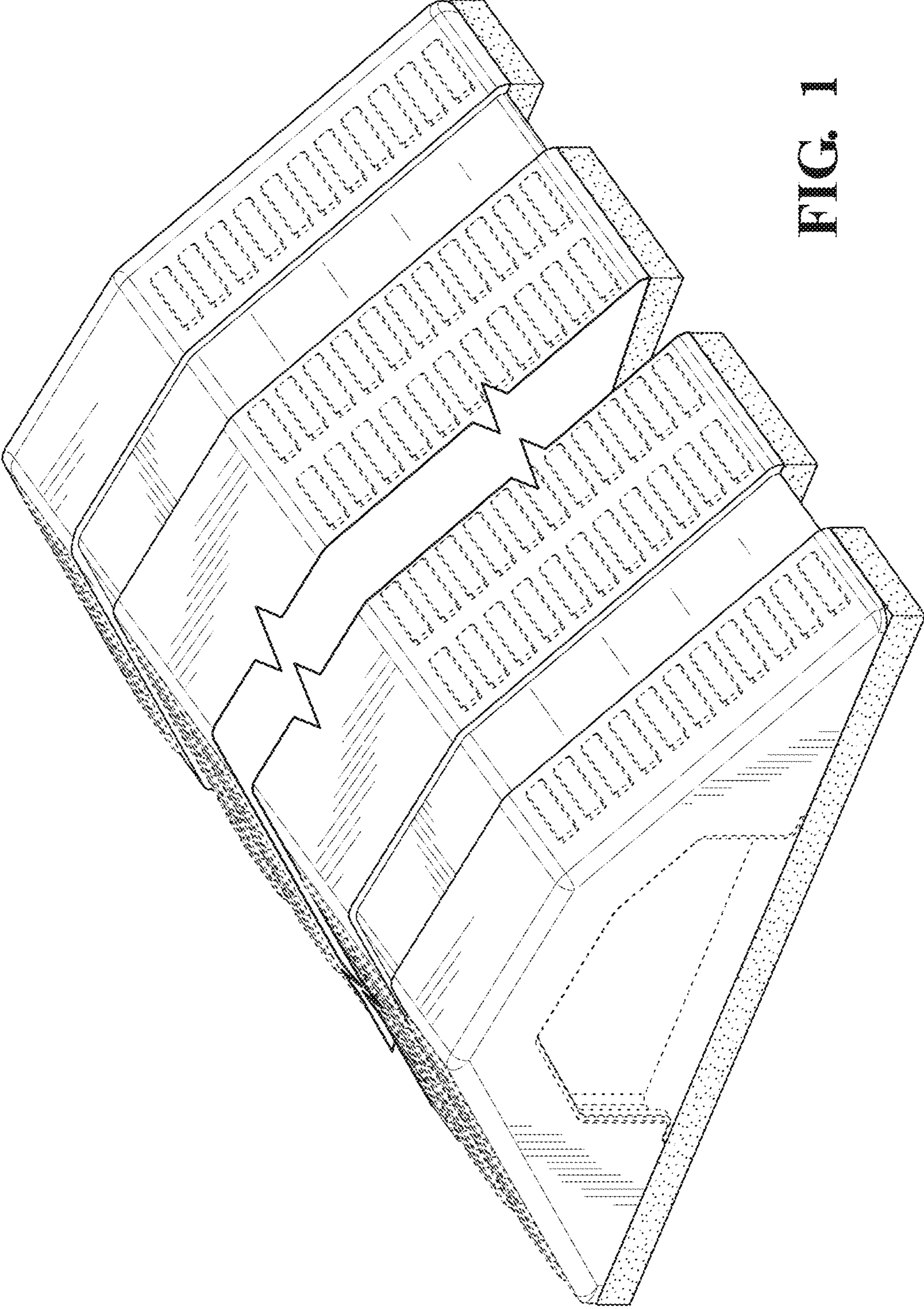

FIG. 1

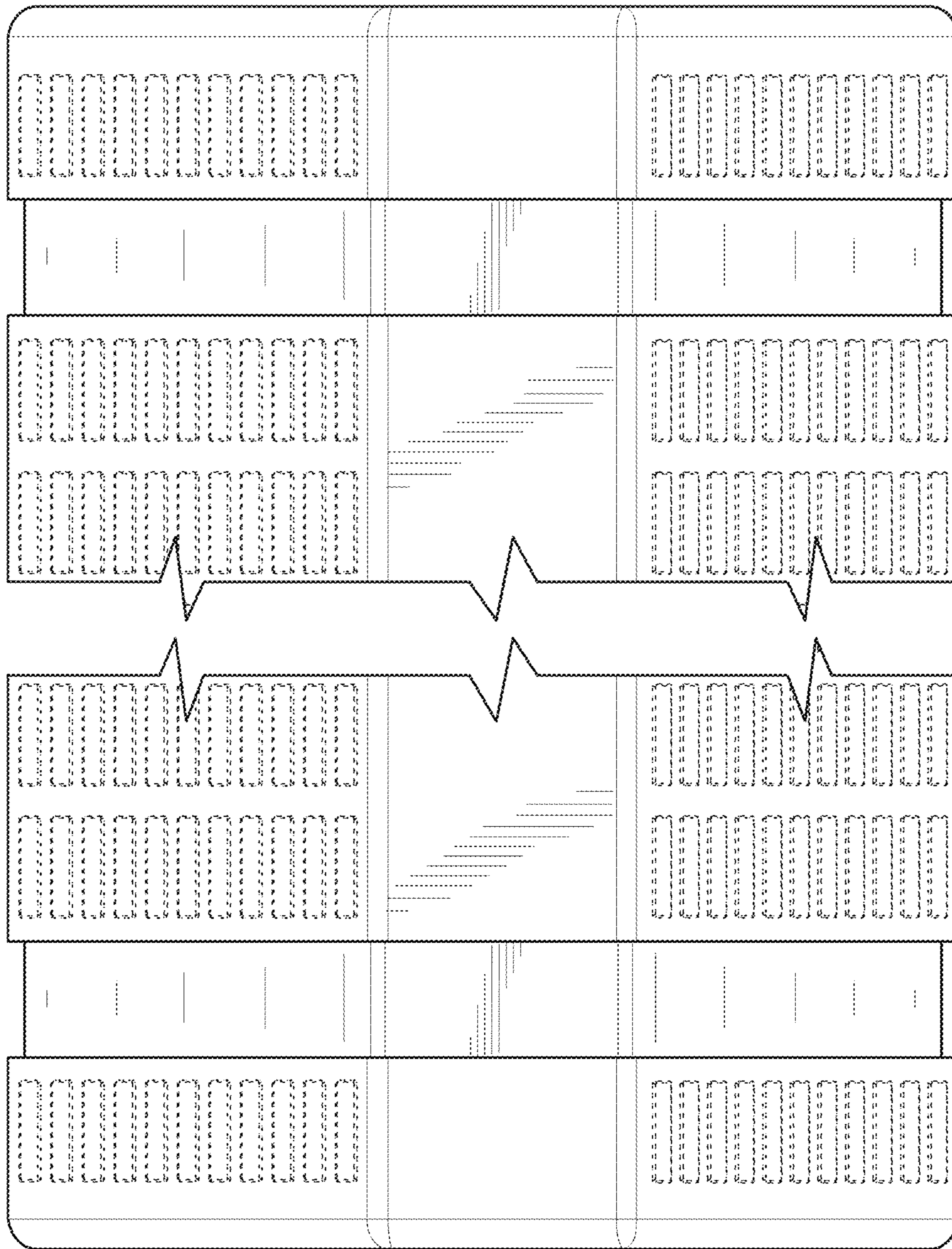

FIG. 2

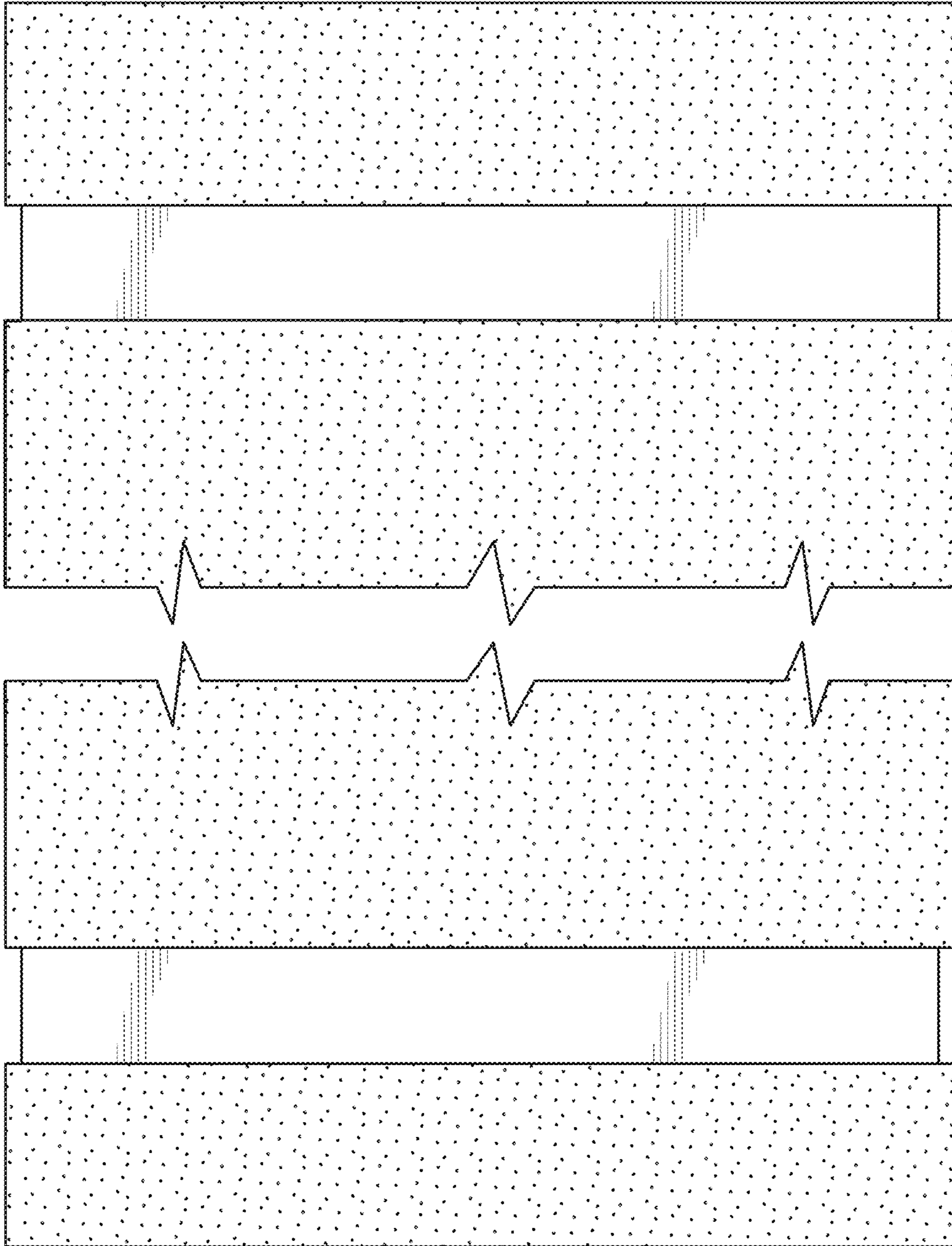

FIG. 3

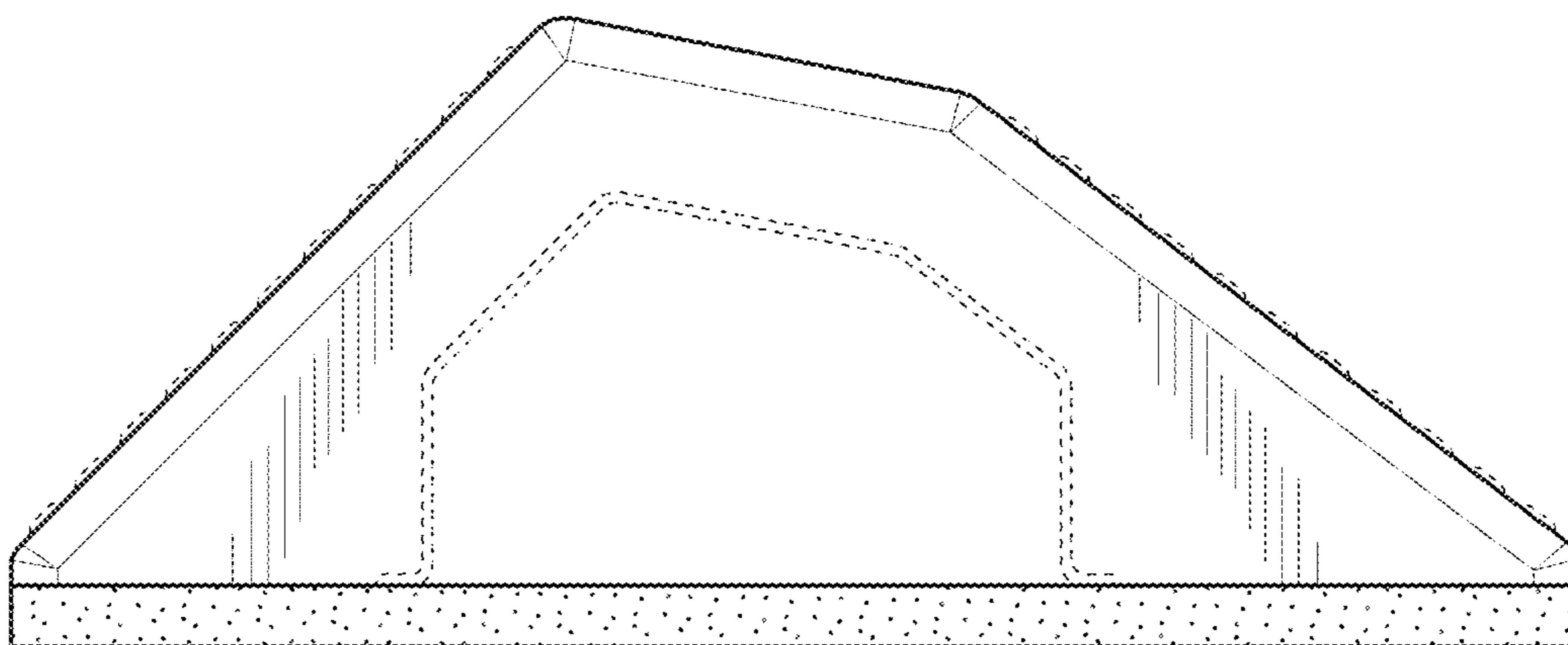

FIG. 4

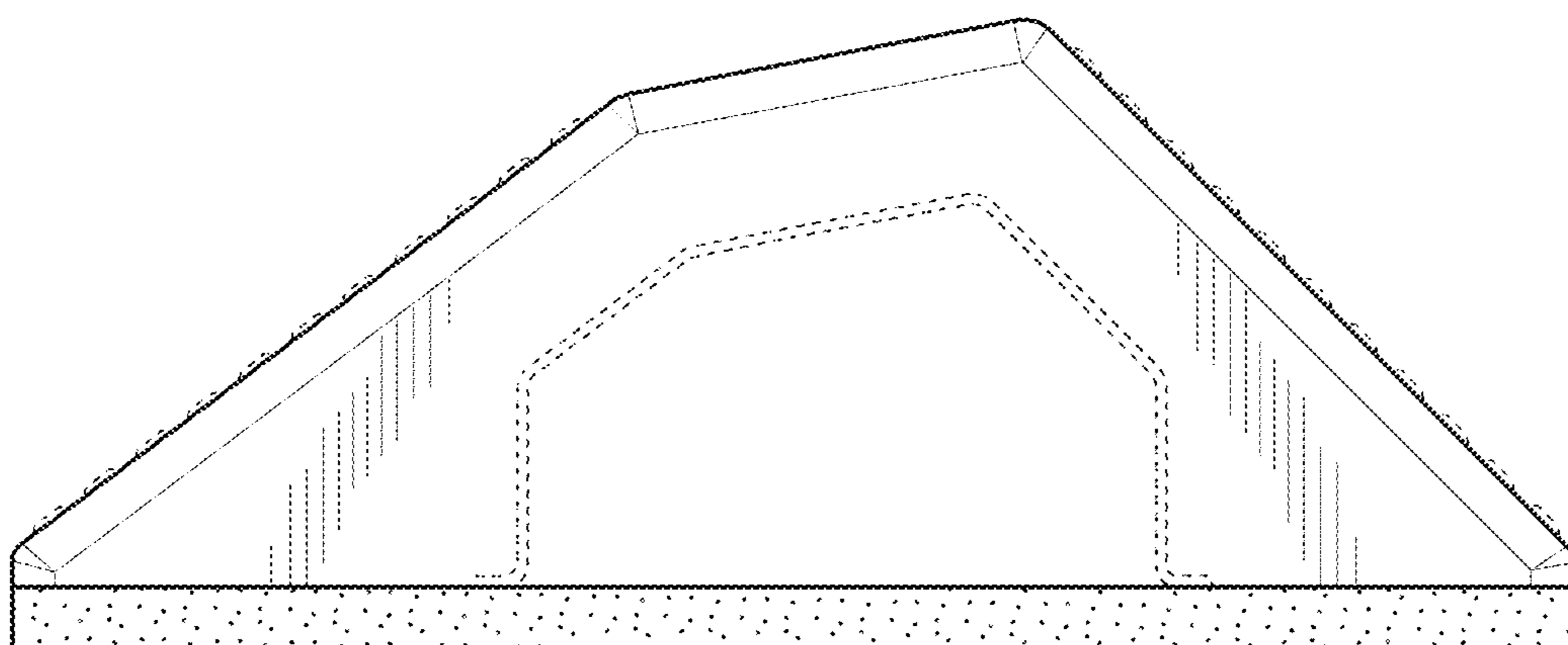

FIG. 5

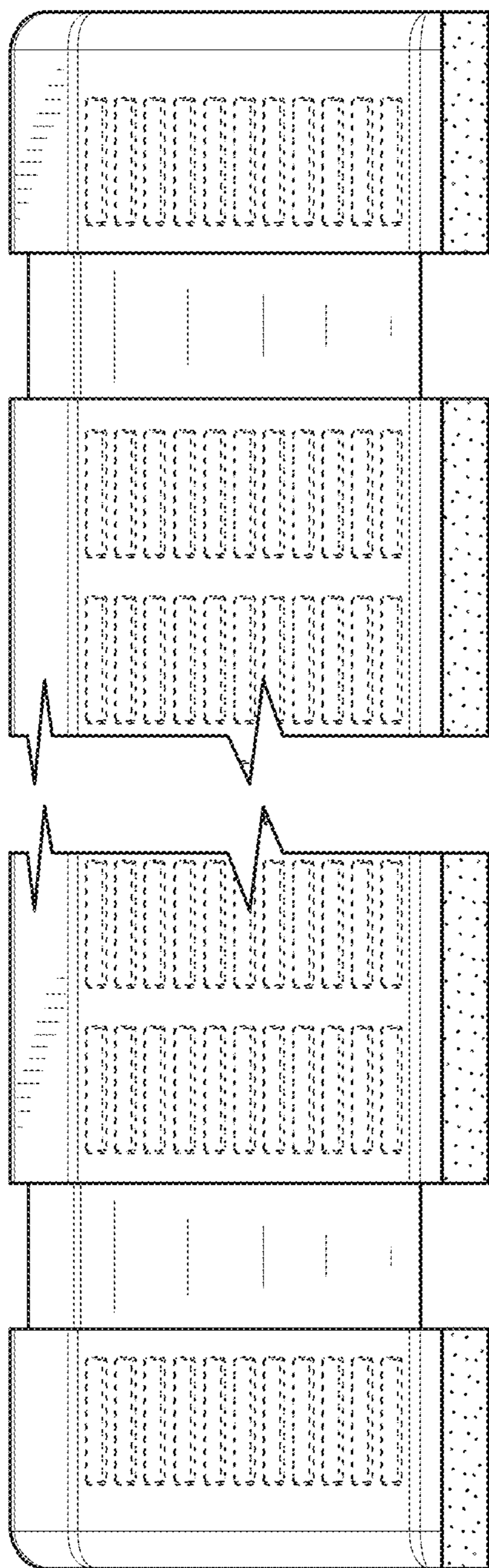

FIG. 6

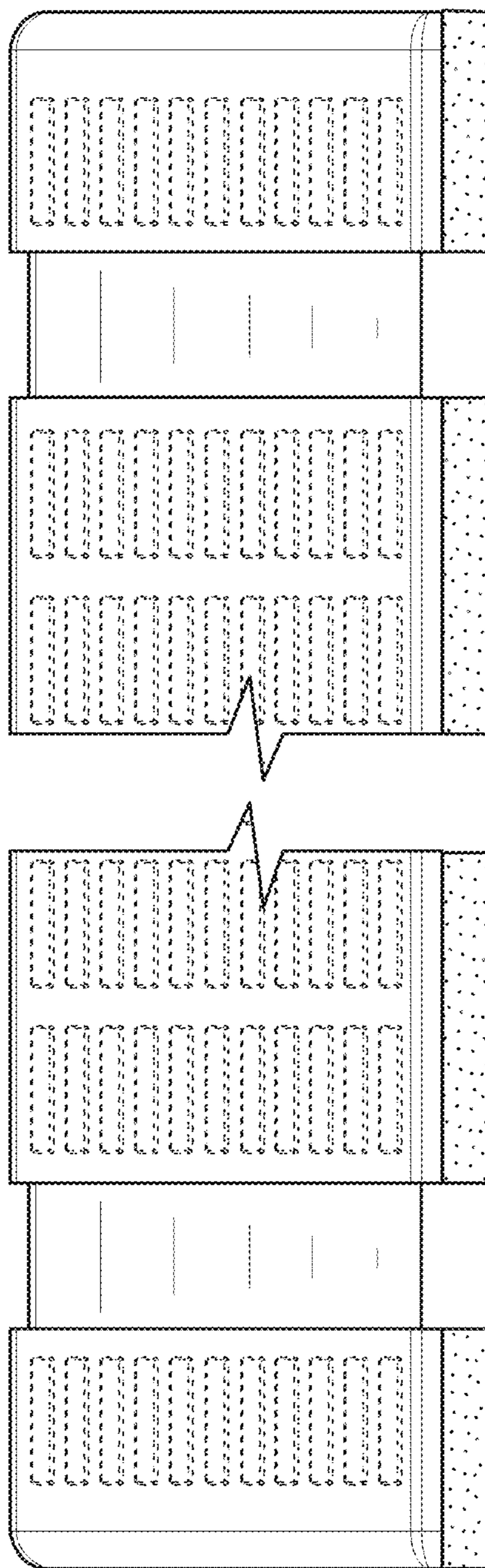

FIG. 7

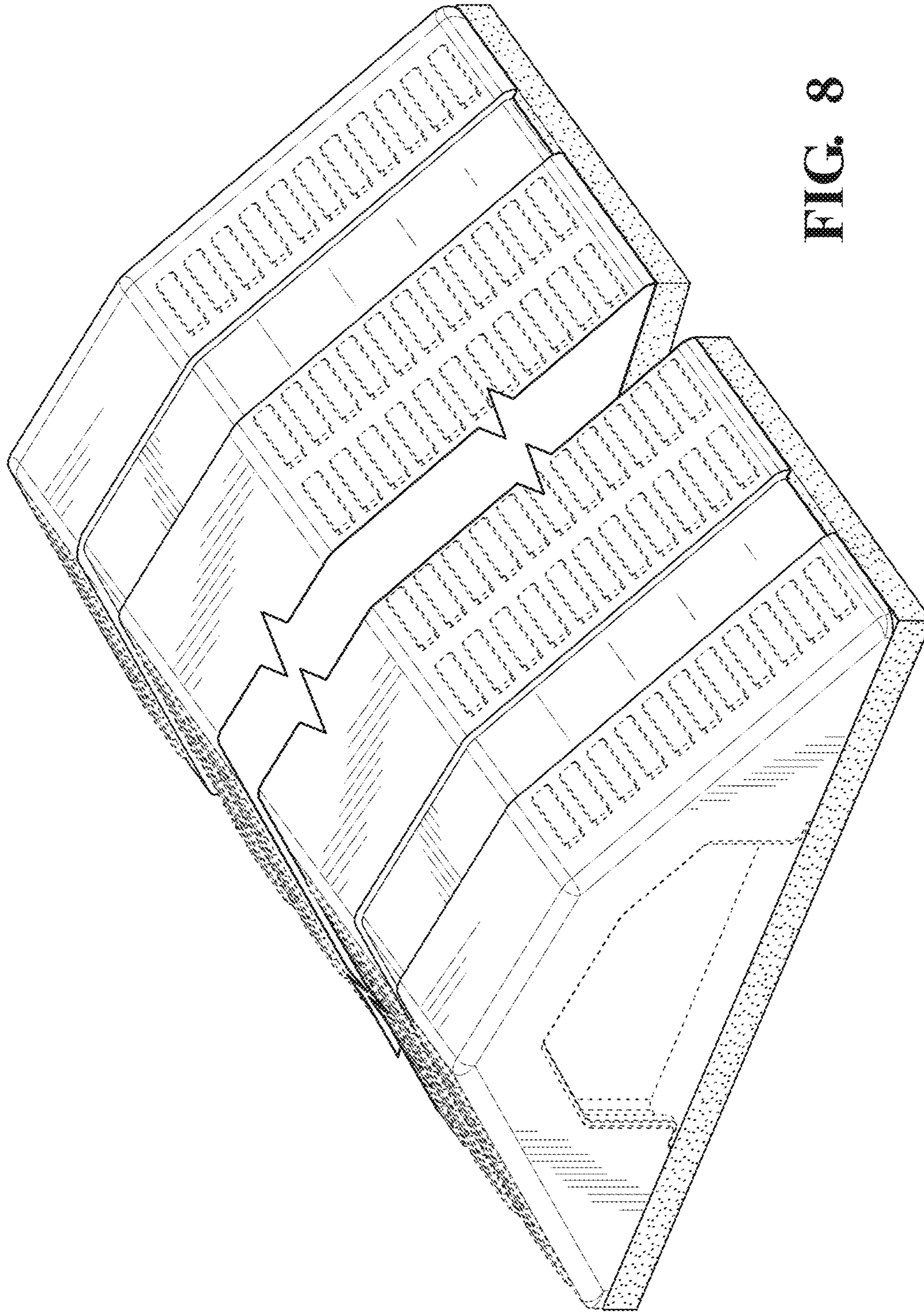

FIG. 8

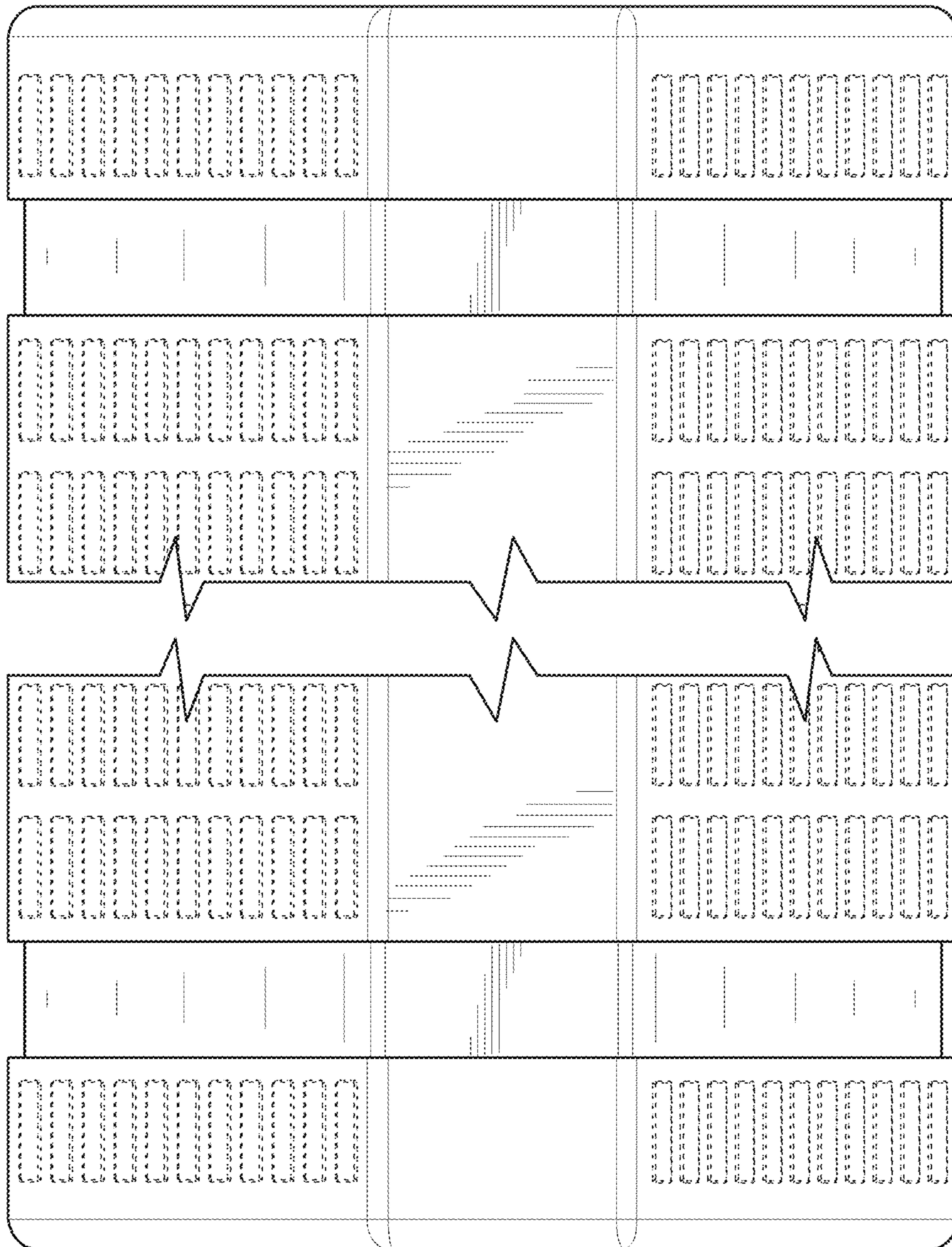

FIG. 9

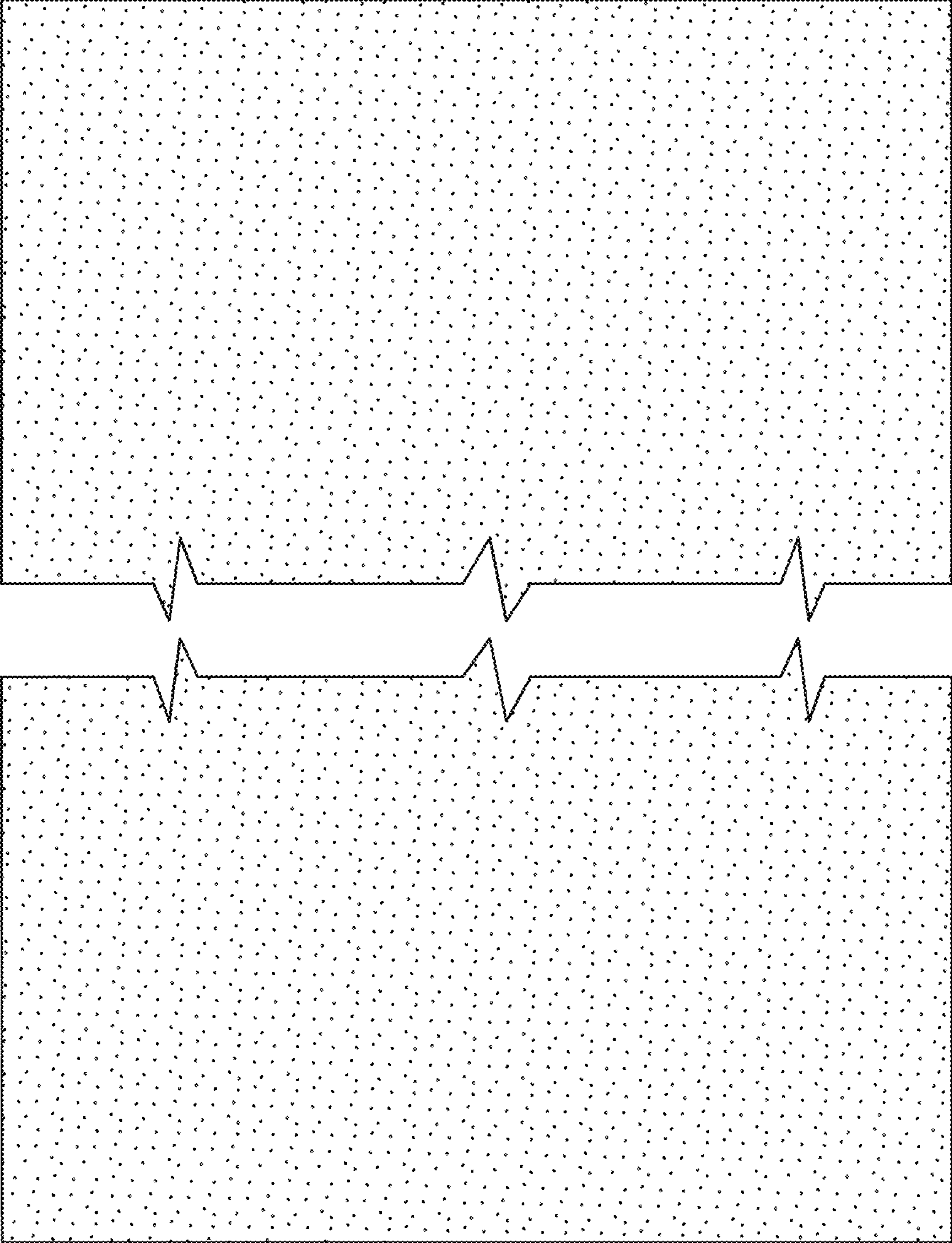

FIG. 10

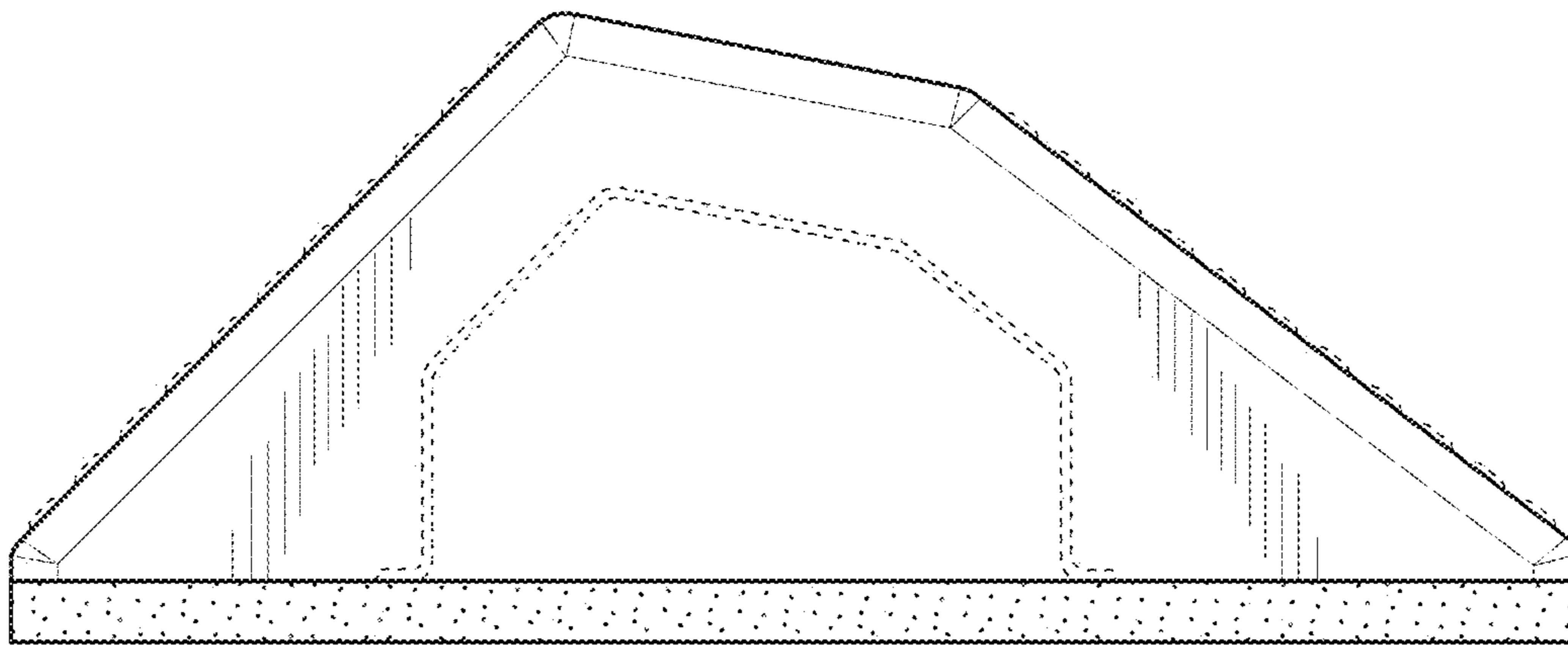

FIG. 11

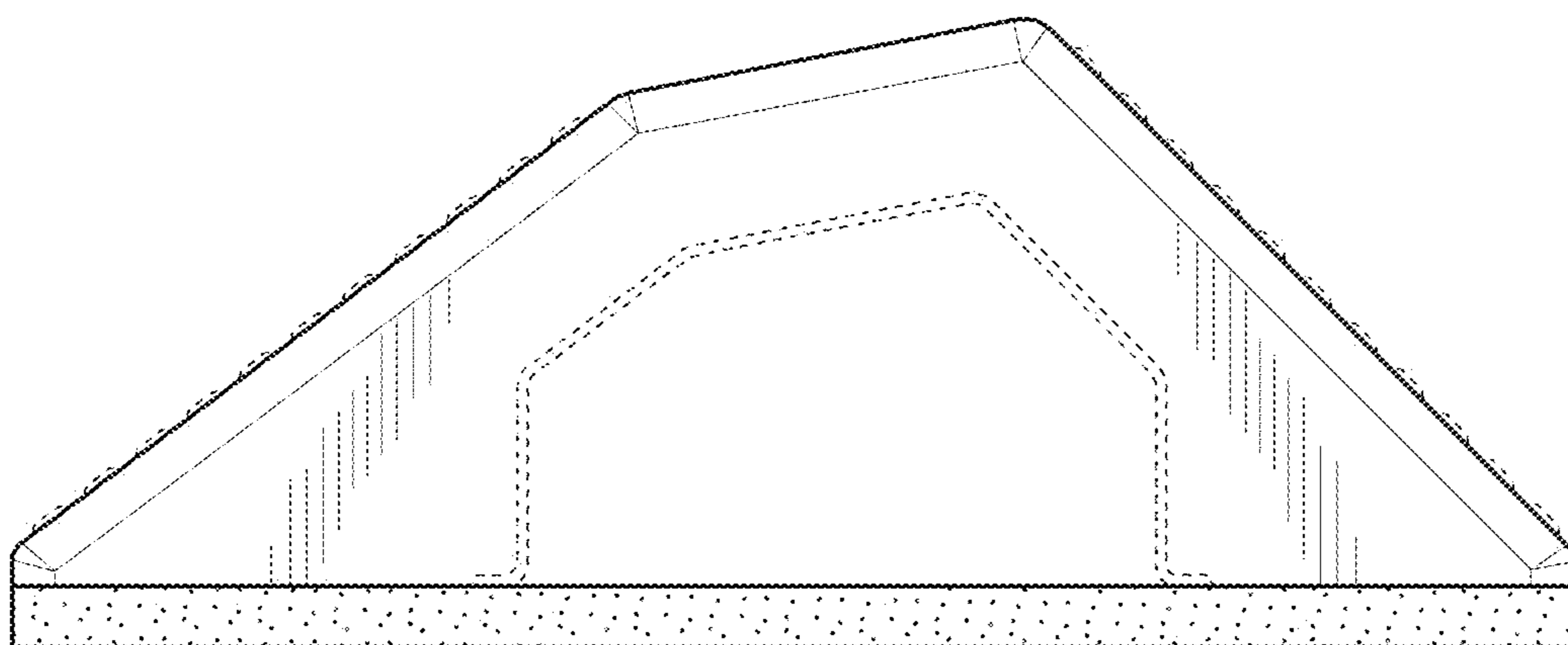

FIG. 12

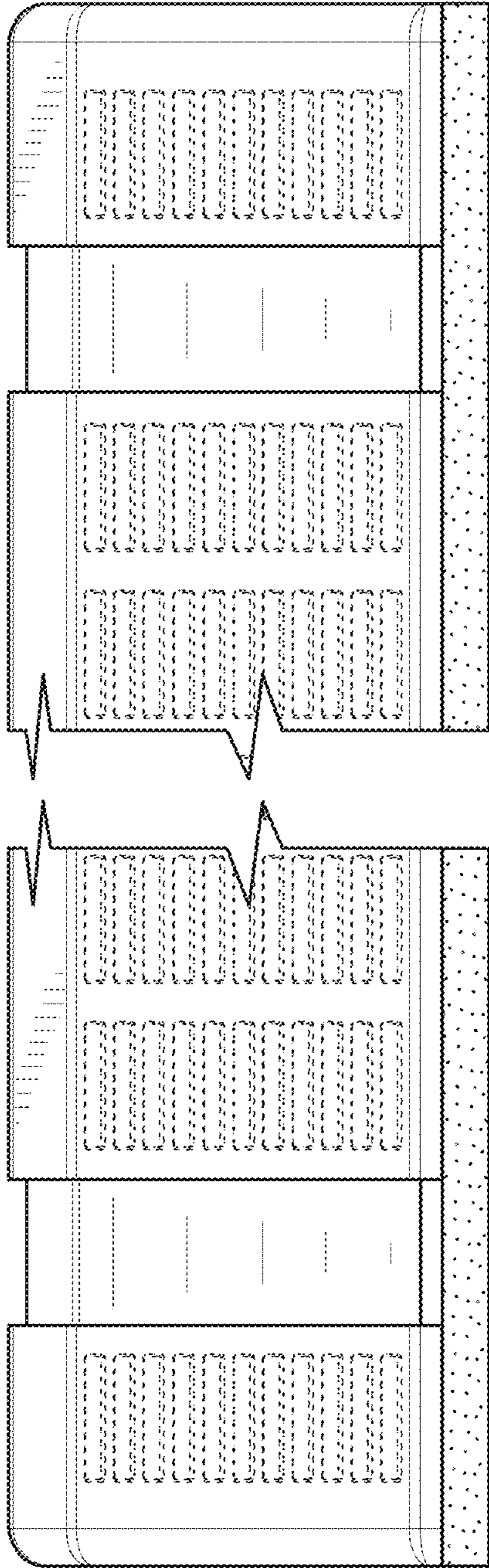

FIG. 13

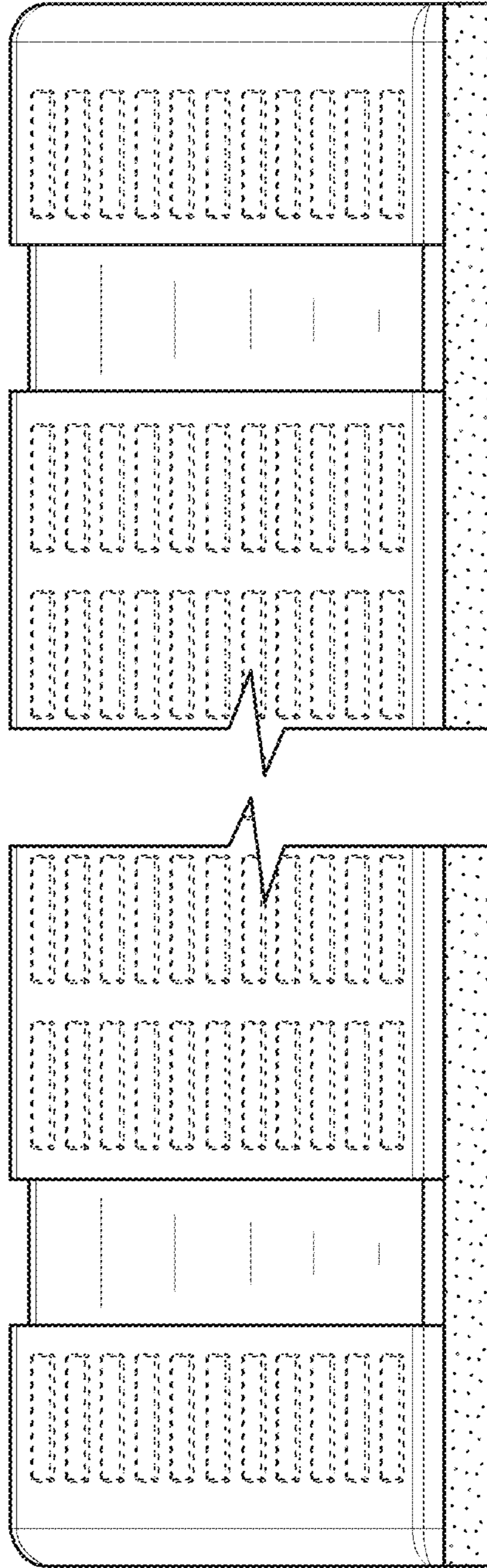

FIG. 14